

ORAC[®]
DECOR

ITALIER

Walls

the ABC
of wall
decoration



ORAC[®]
D E C O R

GIVE WALLS *PERSONALITY*

en —

Walls have power. They can be invisible, but they can be so much more. Walls tie a room together or divide it. They determine the mood of a space, whether serenity, grandeur, homeliness or festivity.

We believe walls are the most important element of an interior. And that's why we're so passionate about them. Orac Decor builds on 50 years of history, innovation and quality to revive heritage and create the walls of the future. Let us share our passion with you.

it —

Le pareti sono molto importanti. Possono essere invisibili, ma possono essere molto di più. Le pareti possono collegare le stanze tra di loro o dividerle. Possono determinare l'atmosfera di un ambiente: serena, maestosa, familiare o festosa.

Riteniamo che le pareti siano l'elemento più importante di un interno. Ed è per questo motivo che sono al centro della nostra attenzione. Orac Decor si basa su 50 anni di storia, innovazione e qualità per far rivivere le tradizioni e gli stili del passato e creare le pareti del futuro. Condividiamo con voi la nostra passione.

pt —

As paredes têm energia. Podem ser invisíveis, mas podem ser muito mais. As paredes podem unir uma divisão ou dividi-la. Estas conseguem determinar o estado de espírito de um espaço, seja pela serenidade, grandeza, simplicidade ou festividade.

Acreditamos que as paredes são o elemento mais importante de um interior. É por isso que somos tão apaixonados por elas. A Orac Decor baseia-se em 50 anos de história, inovação e qualidade para relançar a antiga herança e criar as paredes do futuro. Deixe-nos partilhar consigo a nossa paixão.

ro —

Pereții emană putere. Ei pot fi invizibili, dar, de asemenea, pot fi mult mai mult. Pereții pot transforma o cameră într-un tot unitar sau o pot diviza. Ei pot defini atmosfera unui spațiu, indiferent dacă aceasta este senină, grandioasă, primitoare sau festivă.

Credem că pereții sunt cel mai important element al unui interior. Tocmai de aceea, reprezintă marea noastră pasiune. Orac Decor beneficiază de 50 de ani de experiență, inovație și calitate, ce îi permit să readucă la viață vechea tradiție, dar și să creeze pereții viitorului. Permiteți-ne să vă împărtășim pasiunea noastră.

cz —

Stěny mají velkou moc. Mohou být neviditelné, ale dokážou toho mnohem více. Stěny mohou prostor spojit nebo rozdělit. Mohou prostoru dodat atmosféru – poklidnou, majestátní, útulnou nebo slavnostní.

Věříme, že stěny jsou nejdůležitějším prvkem interiéru. A proto se jimi tak nadšeně zabýváme. Společnost Orac Decor staví na 50leté historii, inovaci a kvalitě, a ožívuje tak staré dědictví a vytváří stěny budoucnosti. Dovolte nám, abychom se s vámi podělili o naši vášně.

Content

it —

- 06 The wall says it all
- 20 Ingresso
- 24 Soggiorno
- 32 Cucina
- 38 Camera da letto
- 44 Bagno
- 50 Bar | Ristorante | Hotel

- 58 Materiali
- 60 **Sommario Prodotti**
- 62 Cornici Soffitto
- 88 Battiscopa
- 104 Cornici Parete
- 116 Rivestimento murale 3D
- 130 Illuminazione Indiretta
- 144 Elementi Decorativi
- 154 La Finitura Perfetta
- 156 Profili Flessibili

ro —

- 06 The wall says it all
- 20 Hol
- 24 Sufragerie
- 32 Bucatarie
- 38 Dormitor
- 44 Baie
- 50 Bar | Restaurante | Hotel

- 58 Materiale
- 60 **Rezumatul Produselor**
- 62 Cornise
- 88 Plinte
- 104 Brauri
- 116 Panouri Decorative 3D
- 130 Iluminat Indirect
- 144 Elemente Decorative
- 154 Finisarea Perfecta
- 156 Produce Flexibile



en —

- 06 The wall says it all
- 20 Hall
- 24 Living room
- 32 Kitchen
- 38 Bedroom
- 44 Bathroom
- 50 Bar | Restaurant | Hotel

- 58 Materials
- 60 **Product Overview**
- 62 Cornices
- 88 Skirting
- 104 Panel Mouldings
- 116 3D Wall Covering
- 130 Indirect Lighting
- 144 Deco Elements
- 154 The Perfect Finish
- 156 Flexible products

pt —

- 06 The wall says it all
- 20 Hall
- 24 Sala
- 32 Cozinha
- 38 Quarto
- 44 Casa de Banho
- 50 Bar | Restaurante | Hotel

- 58 Materiais
- 60 **Resumo de Produto**
- 62 Sancas
- 88 Rodapés
- 104 Perfis
- 116 Revestimento de parede 3D
- 130 Iluminação Indireta
- 144 Elementos Decorativos
- 154 O Acabamento Perfeito
- 156 Produtos Flexíveis

cz —

- 06 The wall says it all
- 20 Hala
- 24 Obývací místnost
- 32 Kuchyně
- 38 Ložnice
- 44 Koupelna
- 50 Bar | Restaurace | Hotel

- 58 Materiály
- 60 **Přehled Produktů**
- 62 Stropní Lišty
- 88 Podlahové Lišty
- 104 Lemovací Lišty
- 116 3D Nástěnné Obložení
- 130 Nepřímé Osvětlení
- 144 Dekorativní Prvky
- 154 Perfektní Zakončení
- 156 Ohebné Produkty

The wall says it all

it —

Esplora la nostra Casa della Personalità. Lascia che la tua creatività prenda il sopravvento mentre ti sposti dalla camera da letto al bagno e dalla cucina al soggiorno. Immagina di trasferire la tua personalità nelle pareti. Cosa ti ispirerà oggi?

pt —

Explore a nossa casa com personalidade. Deixe a sua criatividade fluir do quarto para a casa de banho e da cozinha para a sala de estar. Imagine que pode dar a sua personalidade às paredes. O que o(a) vai inspirar hoje?

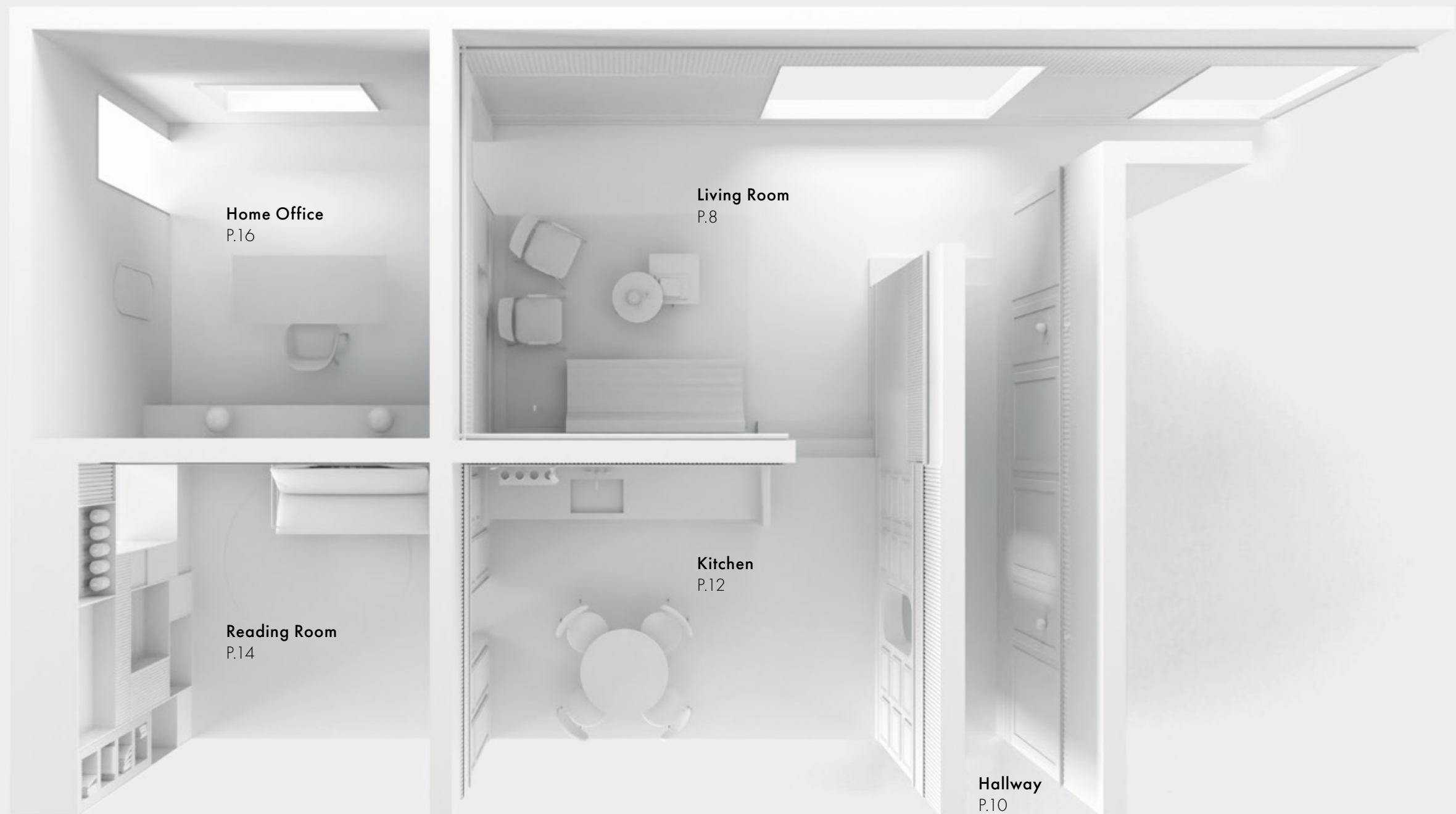

6

7

House of Personality

Explore our House of Personality.

Let your creativity take over as you move from bedroom to bathroom and from kitchen to living room. Imagine injecting your personality on the walls. What will inspire you today?

ro —

Explorați Casa Personalității. Lăsați-vă creativitatea să lucreze în timp ce vă deplasați din dormitor în baie și din bucătărie în sufragerie. Imaginați-vă cum ar fi să vă transpuneți personalitatea pe pereți. Ce vă va inspira astăzi?

cz —

Prozkoumejte náš dům s charakterem. Projděte se z ložnice do koupelny a z kuchyně do obývacího pokoje a popusťte při tom uzdu své kreativitě. Představte si, že chcete stěnám vtisknout svou osobnost. Co vás dnes inspiruje?

Discover our
House of
Personality



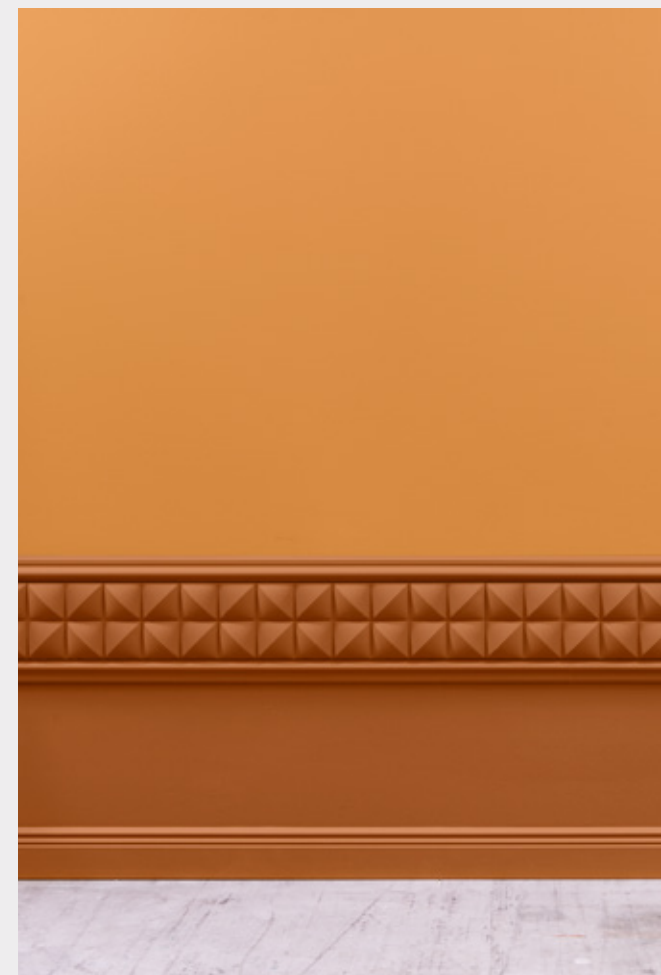

Wall structure and surface textures are combined to create this **relaxing living room**.



it —

La struttura delle pareti e le texture delle superfici si combinano per dar vita a questo salotto rilassante.

ro —

Structura peretelui și texturile de pe suprafața acestuia se combină pentru a crea această cameră de zi relaxantă.

pt —

A estrutura da parede e as texturas das superfícies são combinadas para criar uma sala de estar relaxante.

cz —

Kombinace struktury stěn a textury povrchu společně utváří tento relaxační obývací pokoj.



Strong patterns
and graphic lines
transform a dull
passage into an
eye-catching
entrance.



it —

Motivi e linee grafiche forti trasformano immediatamente uno spazio buio e monotono in un corridoio bello e appariscente.

pt —

Os padrões fortes e as linhas gráficas transformam, de imediato, o espaço escuro e aborrecido num corredor elegante.

ro —

Modelele puternice și liniile grafice transformă imediat un spațiu întunecat și plictisitor într-un hol atractiv.

cz —

Výrazné vzory a grafické linie okamžitě promění tmavý a nudný prostor v atraktivní předsíň.

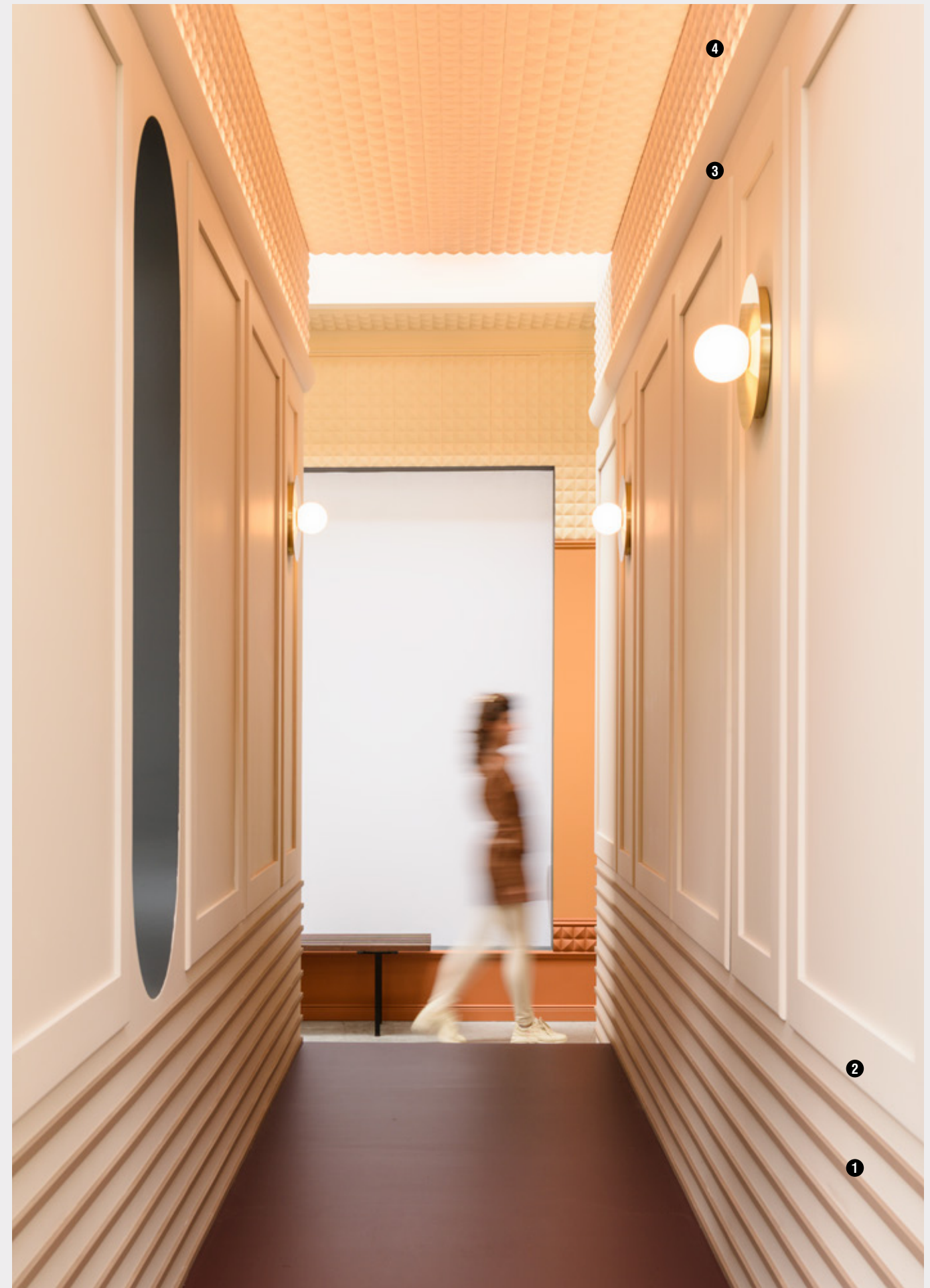

Unconventional combinations in our cosmopolitan kitchen bring daily inspiration.

it —

Le combinazioni inconsuete della nostra cucina cosmopolita sono una fonte d'ispirazione quotidiana.

ro —

Combi-na-țiile neconven-ționale din bucătăria noastră metropolitană sunt o sursă zilnică de inspirație.

pt —

As combinações não convencionais da nossa cozinha cosmopolita são uma fonte de inspiração diária.

cz —

Nekonvenční kombinace v naší kosmopolitní kuchyni jsou každodenním zdrojem inspirace.



12

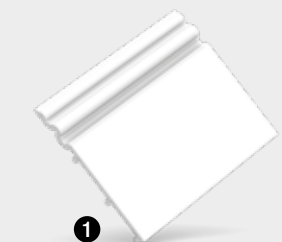

13

Kitchen



1. W110 p.118 | 2. W108 p.118 | 3. W112 p.122 | 4.W130 p.120 | 5. W109 p.118 | 6. W111 p.120 | 7. W113 p.122 | 8. CX190 p.98

Linear, curved or ornamented. The variety of shapes in this **eclectic reading room** energise me to express myself.

it —

Lineari, curve o ornate. Le forme di questa stanza eclettica mi stimolano a esprimermi.

ro —

Liniar, curbat sau decorat. Formele din această camera de lectură eclectică mă energizează pentru a-mi exprima personalitatea.

pt —

Linear, curva ou ornamentada. Nesta sala eclética, as formas motivam-me a exprimir-me a mim próprio(a).

cz —

Lineární, zakřivené nebo ozdobné. Tvary v této eklektické knihovně mě podněcují k sebevyjádření.

Welcome to my urban business environment where linear repetition creates a structured and organized finish.



1. SX157 p.102 | 2. W112 p.122 | 3. SX194 p.86

it —

Benvenuti nel mio ufficio, dove delicate ripetizioni lineari danno un effetto strutturato e organizzato all'ambiente.

pt —

Bem-vindo ao meu palácio empresarial urbano, onde as repetições subtis de linhas permitem obter um resultado estruturado e organizado.

ro —

Bun venit la sediul meu de afaceri urban, în care repetițiile de modele liniare subtile creează un rezultat structurat și organizat.

cz —

Vítejte v mém městském byznysovém paláci, kde opakující se jemné linie utváří strukturovaný a organizovaný výsledný dojem.

For the love of walls

Inspiring projects bursting with personality

it —

Per pareti più belle – Progetti stimolanti che esprimono personalità.

pt —

Por amor às paredes – Projetos inspiradores repletos de personalidade.

ro —

Din iubire pentru pereți – Proiecte inspirationale, care emană personalitate.

cz —

Z lásky ke stěnám – inspirativní projekty plné charakteru.

18



Hallway



Living Room

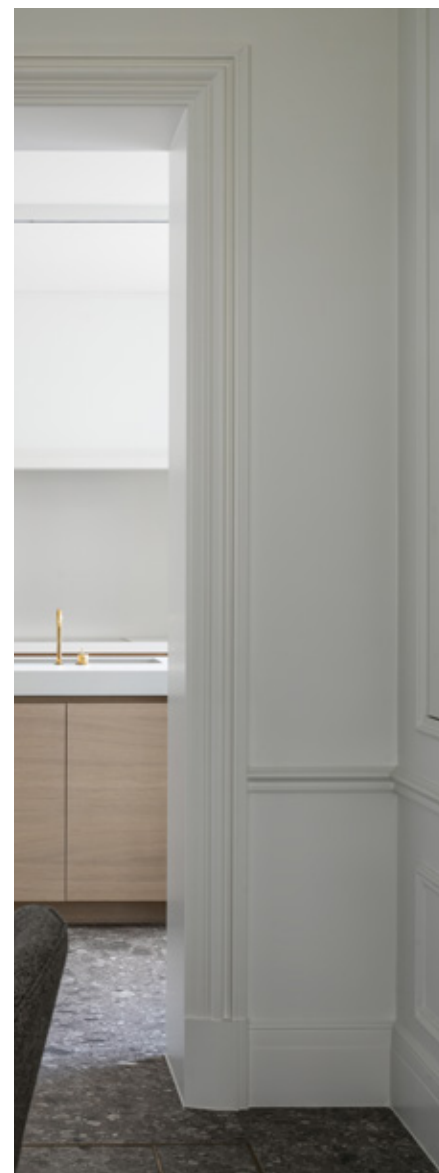

Kitchen



Bathroom



Bedroom



Bar | Resto | Hotel

19

Projects overview

Walls should inspire us,



1. SX163 p.102 | 2. C396 p.77

not limit us



3. SX163 p.102 | 4. P8030 p.106 | 5. C341 p.64

it —
Le pareti devono ispirarci, non
limitarci.

pt —
As paredes devem inspirar-nos,
não limitar-nos.

ro —
Pereții trebuie să ne inspire, nu să
ne limiteze.

cz —
Stěny by nás měly inspirovat,
nikoli omezovat.

Before ...



& after

Instant replay.

Install profiles in repetitive sequences to give your hall depth and structure.

it —

Replay istantaneo. Utilizza i profili in sequenza ripetuta per donare al tuo corridoio un effetto immediato di struttura e profondità.

ro —

Efect unitar instantaneu. Utilizați profilele într-o secvență repetitivă, pentru a oferi profunzime și structură instantanee holului dumneavoastră.

pt —

Reprodução instantânea. Utilize perfis numa sequência repetida para dar uma profundidade e estrutura instantâneas à sua entrada.

cz —

Opakování. Profily použité v opakující se sekvenci dodají chodbě okamžitou hloubku a strukturu.



Walls are not supposed to be boring



24

it —
Le pareti non sono fatte per essere noiose.

ro —
Menirea pereților nu este de a fi plictisitori.

pt —
As paredes não foram concebidas para serem aborrecidas.

cz —
Stěny nebyly vytvořeny, aby nás nudily.

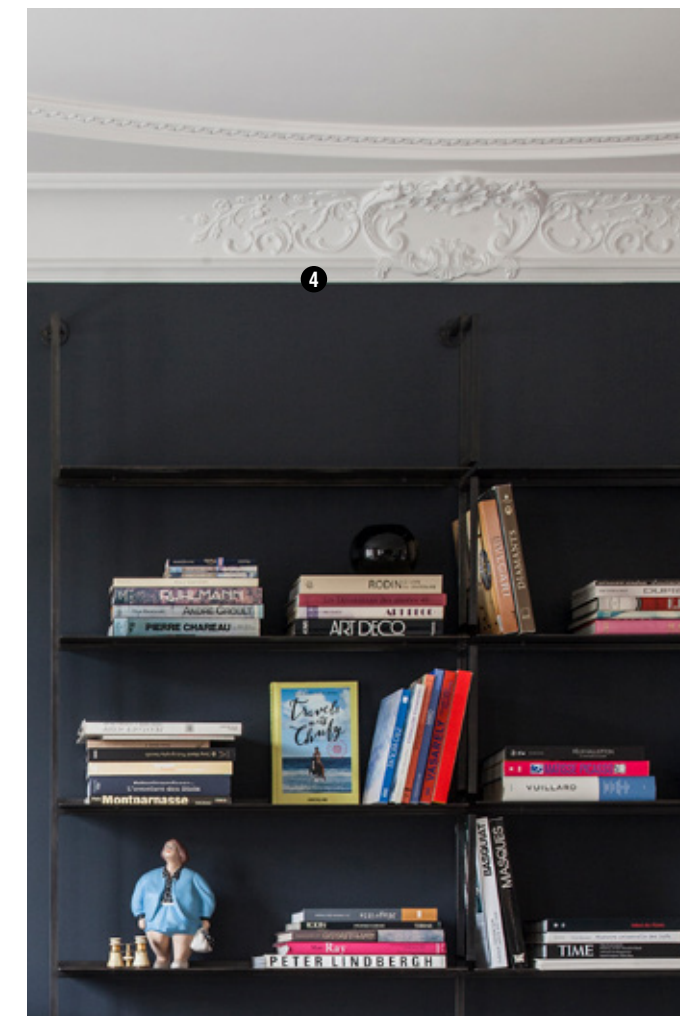

25

Living Room projects



1. SX163 p.102 | 2. P8030 p.106 | 3. C338 p.66 | 4.C338A p.66 | 5.C338B p.66



1. SX163 p.102 | 2. C396 p.77



3. SX118 p.93 | 4. P8020 p.106 | 5. C342 p.64

Composed elegance.
Combine multiple cornice mouldings to create a beautiful transition from wall to ceiling.

it —
Eleganza discreta. Associa diverse modanature di cornici e profili per creare un effetto di transizione unico dalla parete al soffitto.

pt —
Elegância na composição. Combine várias sancas e perfis para criar um efeito de transição singular da parede para o teto.



1. SX156 p.95 | 2. P8030 p.106 | 3. P8020 p.106 | 4. DX170-2300 p.150 | 5. C362 p.142 | 6. P9901 p.108 | 7. C342 p.81 | 8. P8050 p.106

ro —
Eleganță discretă. Combinați mai multe cornise pentru a crea un efect original de tranziție de la perete la plafon.

cz —
Dokonalá elegance. Kombinací několika stropních lišt a profilů vytvoříte jedinečný přechodový prvek mezi stěnou a stropem.



GIVE WALLS *PERSONALITY*

CLASSIC



30

MODERN



ZEN



ECLECTIC



31

Living Room projects



Let your walls do the talking



1. W110F p.118 | 2. W110 p.118 | 3. W121 p.126 | 4. W123 p.126 | 5. W120 p.126 | 6. W122 p.126

it —

Lascia parlare le tue pareti.

pt —

Deixe que as paredes falel por si.

ro —

Creați pereți care transmit un mesaj.

cz —

Nechte vaše stěny promluvit.



1. SX155 p.96 | 2. D330LR p.150 | 3. DX174-2300 p.150 | 4. C342 p.64



Before ...



36

Highlight the ceiling.

Use indirect lighting for a more spacious effect.

it —

Metti in evidenza il soffitto. Utilizza l'illuminazione indiretta per un effetto di maggiore spazio.

pt —

Realce o teto. Utilize a iluminação indireta para um efeito de espaço mais amplo.

ro —

Evidențiază plafonul. Utilizajă iluminarea indirectă pentru a crea impresia de mai mult spațiu.

cz —

Zvýrazněte strop. Nepřímé osvětlení vytváří dojem větší prostornosti.

& after



37

Kitchen projects —



1. PX102 p.111 | 2. PX175 p.111 | 3. SX118 p.93 | 4. PX103 p.111

Walls deserve personality

it —
Le pareti devono esprimere
personalità.

pt —
As paredes merecem
personalidade.

ro —
Pereții merită să aibă
personalitate.

cz —
Stěny si zaslouží osobitost.



1. SX162 p.102 | 2. C396 p.77

Combine modern and classic.

Discover how traditional skirting and wall mouldings perfectly complement a contemporary cornice.



3. SX163 p.102 | 4. P8030 p.106 | 5. P8050 p.106 | 6. C393 p.77

it —

Abbina stile moderno e stile classico. Scopri come i battiscopa tradizionali e le modanature delle pareti si integrano perfettamente con una cornice contemporanea.

ro —

Combinăți aspectul modern cu cel clasic. Descoperiți modul în care plintele și mulurile de perete tradiționale devin completarea perfectă a unei cornișe contemporane.

pt —

Combine os estilos moderno e clássico. Descubra como os rodapés e as molduras tradicionais complementam na perfeição a sanca contemporânea.

cz —

Kombinujte moderní a klasické. Objevte, jak tradiční soklové lišty a lemovací lišty dokonale doplňují moderní stropní lištu.

GIVE WALLS
PERSONALITY

ZEN



42

CLASSIC



ECLECTIC



MODERN



43
Bathroom projects

Bring your walls



to life

it —

Dai nuova vita alle tue pareti.

pt —

Dê vida às suas paredes.

ro —

Insuflați viață pereților
dumneavoastră.

cz —

Vdechněte stěnám život.



1. SX118 p.93 | 2. PX103 p.111 | 3. C343 p.64



Well-dressed windows.

Use our curtain profiles to hide your curtain rails in an instant for non-stop elegance.

it —

Finestre ben curate. Usa i nostri profili per tende per nascondere le guide per tende, per un'eleganza immediata.

pt —

Janelas elegantes. Utilize as nossas sancas para cortinados para ocultar os varões dos cortinados e proporcionar uma elegância instantânea.



3. C342 p.81

ro —

Ferestre frumos decorate. Utilizați profilele noastre pentru perdele pentru a ascunde șinele acestora, obținând instantaneu un aer de eleganță.

cz —

Dobře oblečená okna. Pomocí našich garnýžových profilů můžete okamžitě a elegantně skrýt závěsné systémy.



1. SX162 p.102 | 2. C396 p.77

GIVE WALLS *PERSONALITY*

MODERN



48

CLASSIC



ECLECTIC



ZEN



49
Bedroom projects



50

Every wall is an invitation
to create beauty



1. W109 p.118 | 2. W109F p.118 | 3. SX105 p.96 | 4.P7070 p.108 | 5. SX187 p.102



it —

Ogni parete è un invito a creare bellezza.

pt —

Cada parede é um convite para criar beleza.

ro —

Fiecare perete este o invitație la creația estetică.

cz —

Každá stěna je výzvou k vytvoření krásy.

51

Bar | Resto | Hotel projects

TON SUR TON — KORTRIJK (BE)



1. P3020 p.107 | 2. P3020A p.115 | 3. P8040 p.106 | 4. SX118 p.93 | 5. P8020 p.106 | 6. P8030 p.106 | 7. C343 p.64

it —

Effetto immediato.
Boiserie alte in pochissimo tempo. Questi pannelli prefabbricati possono essere montati direttamente a parete senza alcun lavoro di preparazione.

ro —

Efect imediat.
Lambrisare la înălțimi în cel mai scurt timp. Aceste panouri prefabricate pot fi montate direct pe perete, fără alte pregătiri.

pt —

Efeito imediato.
Painéis altos rapidamente. Estes painéis pré-fabricados podem ser instalados diretamente na parede sem qualquer trabalho de preparação.

cz —

Okamžitý efekt.
Vysoké obložení ihned. Tyto prefabrikované panely mohou být namontovány přímo na zeď, bez jakýchkoli přípravných prací.



Immediate effect.
Tall wainscoting in no time. These pre-fabricated panels can be mounted directly to the wall without any prep work.

54



1. SX191 p.95 | 2. W121 p.126 | 3. W120 p.126 | 4. C324 p.132 | 5. C990 + P9900 p.75

55

Bar | Resto | Hotel projects

ASTORIA — DE HAAN (BE)



56



1. SX168 p.102 | 2. SX162 p.113

57

Engineered Materials

MATERIALI INGEGNERIZZATI / MATERIAIS DE ENGENHARIA
MATERIALE PROIECTATE INTELIGENT / KONSTRUKČNÍ MATERIÁLY

PUROTOUCH[®]

A high-quality, high-density polyurethane that allows fine details.

Poliuretano di alta qualità e alta densità che consente dettagli ben definiti.

Um poliuretano de alta densidade e de alta qualidade que permite detalhes precisos.

Un poliuretan de înaltă calitate, de înaltă densitate, care permite detalii fine.

Vysoce kvalitní polyuretan vysoké hustoty umožňuje jemné detaily.

Detail Design ★★ ★
Impact Resistance ★★ ★

DUROPOLYMER[®]

An extruded and impact-resistant polymer based on a high-density polystyrene.

Polimero estruso resistente agli urti, formato da una miscela di polistirene ad alta densità.

Polímero extrudido, resistente a impactos, com base numa mistura de poliestireno de alta densidade.

Un polimer extrudat si rezistent la impact pe baza unui polistiren de inalta densitate..

Lisovaný, mechanicky odolný polymer na bázi hustého polystyrénu.

Detail Design ★★ ★
Impact Resistance ★★ ★

DUROFOAM[®]

An extruded lightweight polymer based on a medium-density polystyrene blend.

Polimero leggero estruso, formato da una miscela di polistirene di media densità.

Polímero extrudido, leve, baseado numa mistura de poliestireno de média densidade.

Un polimer extrudat usor pe baza unui polistiren de medie densitate.

Lisovaný lehký polymer na bázi středně husté polystyrénové směsi.

Detail Design ★
Impact Resistance ★



Advantages

VANTAGGI / VANTAGENS / AVANTAJE / VÝHODY

READY TO PAINT

All of our products are ready to paint. RAL-colours on demand.

Tutti i nostri prodotti sono pronti per essere verniciati. Colori RAL su richiesta.

Todos os nossos produtos estão prontos para a pintar. Cores RAL mediante pedido.

Toate produsele noastre sunt gata pentru vopsit. Culoare RAL la cerere.

Všechny naše výrobky jsou připraveny k okamžitému nátěru. Barvy RAL na vyžádání.



DURABLE

Orac Decor products are designed to last a lifetime. Smart design and high-end technology assure strong and water resistant products.

I prodotti Orac Decor sono progettati per durare tutta la vita. Il design intelligente e la tecnologia di alta gamma garantiscono prodotti robusti e resistenti all'acqua.

Os produtos Orac Decor são concebidos para durarem toda a vida. O design inteligente e a tecnologia de ponta garantem produtos fortes e resistentes à água.

Produsele Orac Decor sunt concepute să reziste pe viață. Designul inteligent și tehnologia de vârf asigură produse durabile, rezistente la apă.

Produkty Orac Decor jsou navrženy tak, aby vydržely po celý život. Inteligentní design a špičková technologie přináší mechanicky odolné a voděodolné produkty.



LEGEND

SX118 | SX118F | SX118 - RAL9003
200 x 13,8 x 1,8 cm
Duropolymer[®]

F = Flexible polyurethane version
RAL 9003 = Finished with RAL9003 (white, on stock)
Dimensions
Material

Product Overview



Cornice Mouldings

Cornici Soffitto / Sancas / Cornise / Stropní Lišty

Pg.62



Skirting

Battiscopa / Rodapés / Plinte / Podlahové Lišty

Pg.88



Panel Mouldings

Cornici Parete / Perfis Brauri / Lemovací Lišty

Pg.104



3D Wall Covering

Rivestimento murale 3D / Revestimento de parede 3D
Panouri Decorative 3D / 3D Nástěnné Obložení

Pg.116



Indirect Lighting

Iluminazione Indiretta / Iluminação Indireta
Iluminatul indirect / Nepřímé Osvětlení

Pg.130



Deco Elements

Elementi Decorativi / Elementos Decorativos
Elemente Decorative / Dekorativní Prvky

Pg.144

The Perfect Finish

La Finitura Perfetta / O Acabamento Perfeito / Inisarea Perfecta / Perfektní Zakončení

Pg.154



Cornice Mouldings

CORNICI SOFFITTO / SANCAS
CORNISE / STROPNÍ LIŠTY

62



en —

Your walls don't stop when they touch the ceiling. Add a splash of your personality to this transition area – and let it continue onto the ceiling with our cornice mouldings. Available in a range of styles from sleek to baroque, from decorative to functional.

it —

Le pareti non finiscono quando arrivano al soffitto. Aggiungi un tocco di personalità a quest'area di transizione e lascia che arrivi al soffitto con le nostre cornici per soffitto. Disponibili in una vasta gamma di stili, dal raffinato al barocco, dal decorativo al funzionale.

pt —

As suas paredes não param quando tocam no teto. Acrescente um toque de personalidade a esta área de transição e dê-lhe continuidade até ao teto com as nossas sancas. Disponível numa variedade de estilos, do elegante ao barroco, do mais decorativo ao mais funcional.

ro —

Pereții nu se opresc la punctul în care ating plafonul. Adăugați un strop de personalitate acestei zone de tranziție și lăsați-o să se continue pe plafon, cu ajutorul cornișelor noastre. Disponibile într-o gamă variată de stiluri, de la minimaliste la baroc, de la decorative la funcționale.

cz —

Stěny se u stropu nemusí zastavit. Dodejte této přechodové oblasti trochu osobitosti a navažte designem stěny i na stropě s našimi stropními lištami. K dostání v řadě stylů: od elegantních po barokní, od dekorativních po funkční.

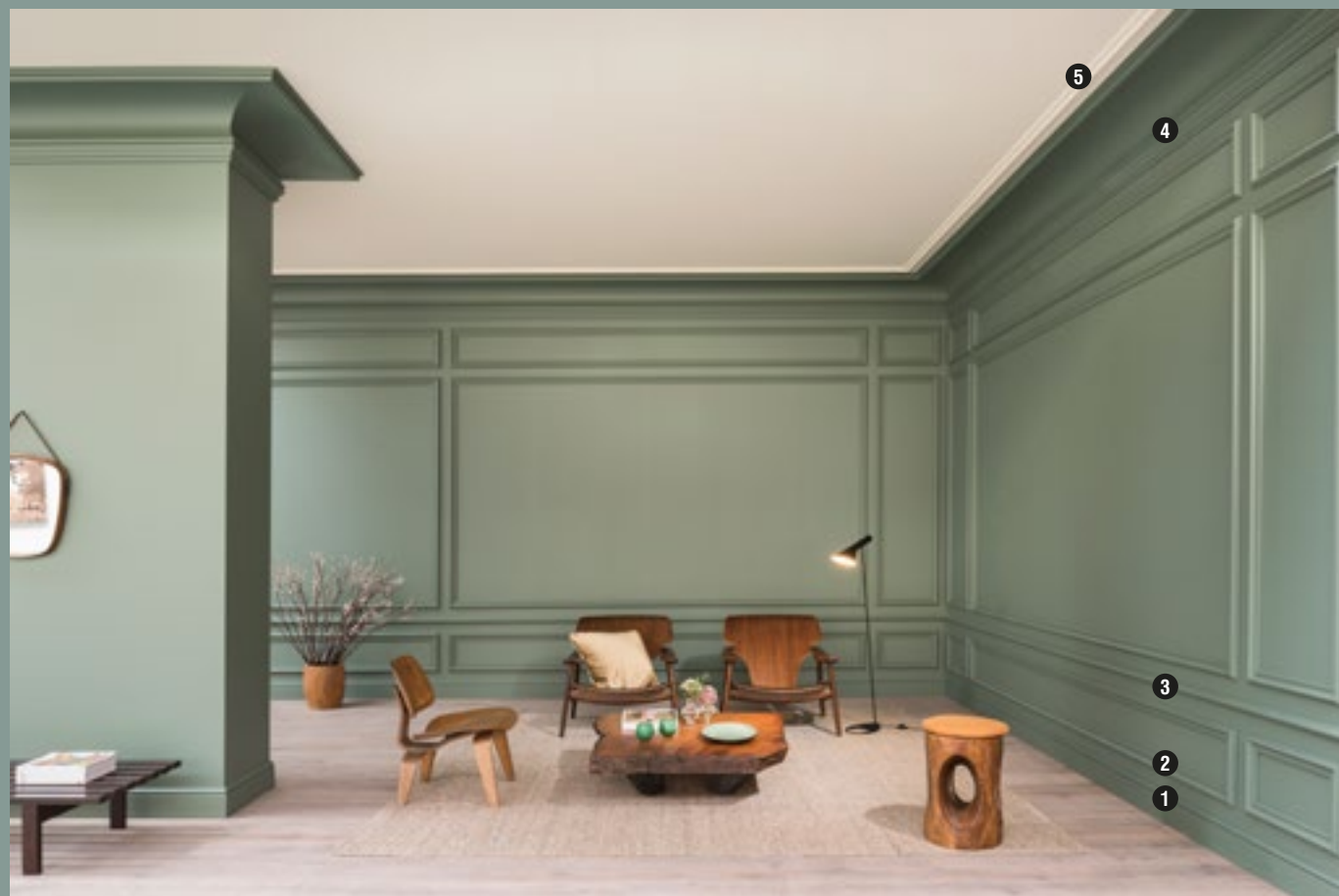

C325 | C325F MANOIR
200 x 7 x 6,5 cm
Purotouch®

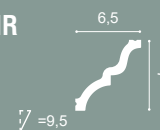

C326 | C326F MANOIR
200 x 10,5 x 9 cm
Purotouch®

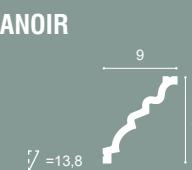

9 C327 MANOIR
200 x 14,3 x 15,9 cm
Purotouch®

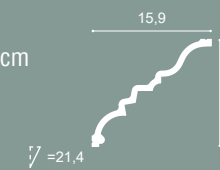

64



C341 | C341F HERITAGE

200 x 8,8 x 12,2 cm
Purotouch®

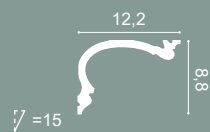

C342 HERITAGE

200 x 14 x 19 cm
Purotouch®

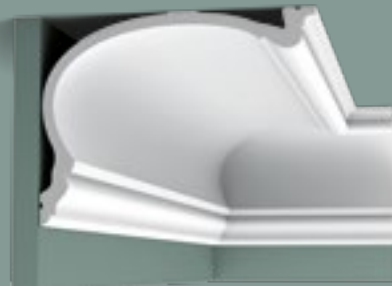
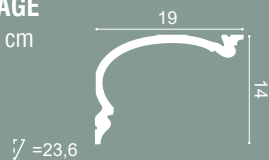

C343 HERITAGE

200 x 19 x 25 cm
Purotouch®

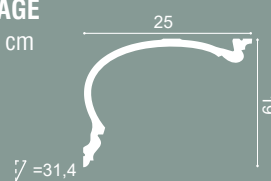

4 C344 HERITAGE

200 x 27,3 x 35 cm
Purotouch®

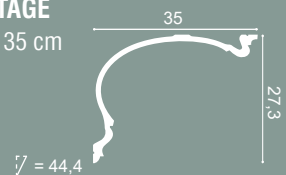

65



C230 | C230F
200 x 2,9 x 2,9 cm
Purotouch[®]

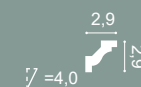

C215 | C215F
200 x 4,7 x 4,7 cm
Purotouch[®]



C322
200 x 5 x 4,2 cm
Purotouch[®]

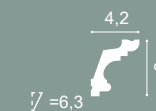

C200
200 x 6,5 x 5,7 cm
Purotouch[®]

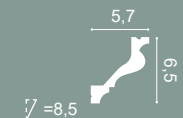

C220 | C220F
200 x 7,6 x 11,6 cm
Purotouch[®]



C213 | C213F
200 x 8 x 8 cm
Purotouch[®]

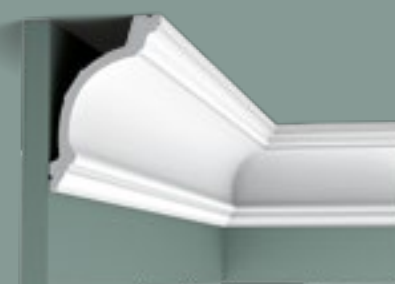

C217 | C217F
200 x 10,3 x 15,6 cm
Purotouch[®]

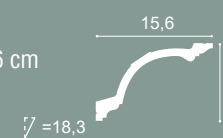

C217 | C217F
200 x 15,6 x 10,3 cm
Purotouch[®]

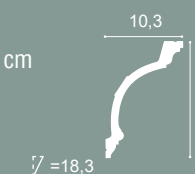

C216
200 x 11,6 x 13,3 cm
Purotouch[®]

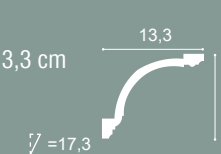

C301
200 x 17 x 14,4 cm
Purotouch[®]

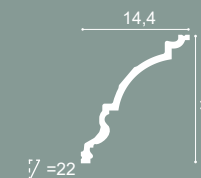

2 C338
200 x 18,2 x 18,2 cm
Purotouch[®]

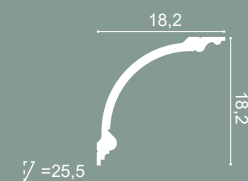

C336
200 x 27,1 x 26,6 cm
Purotouch[®]

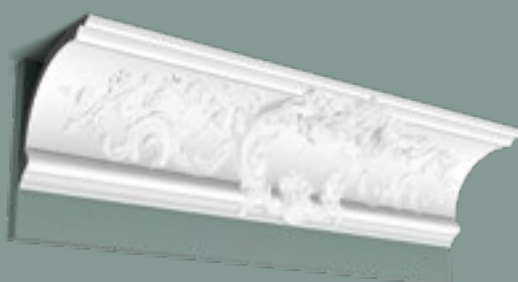
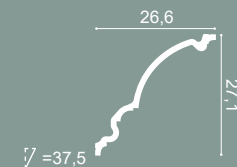

3 C338B BA'ROCK
200 x 18,2 x 18,2 cm
Dessin: 2 x 57 cm
Purotouch[®]

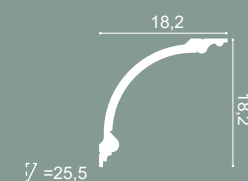

1 C338A BA'ROCK
200 x 18,2 x 18,2 cm
Dessin: 120 cm
Purotouch[®]

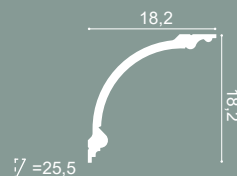



C333 | C333F
200 x 12,2 x 11,1 cm
Purotouch®

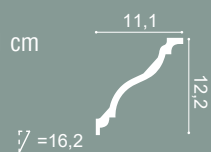

C331 | C331F
200 x 6,4 x 13,5 cm
Purotouch®

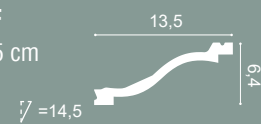

C334 | C334F
200 x 15 x 19,6 cm
Purotouch®

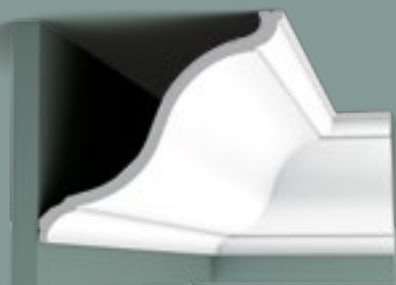
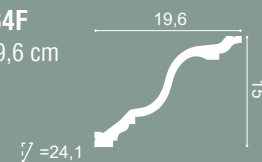

C335
200 x 20,2 x 22,2 cm
Purotouch®
Designed by
Xavier Donck

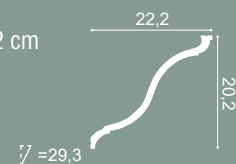

C335
200 x 22,2 x 20,2 cm
Purotouch®
Designed by
Xavier Donck

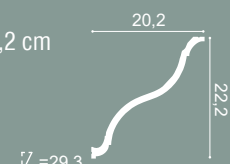

C902 | C902F
200 x 10,3 x 10,3 cm
Purotouch®

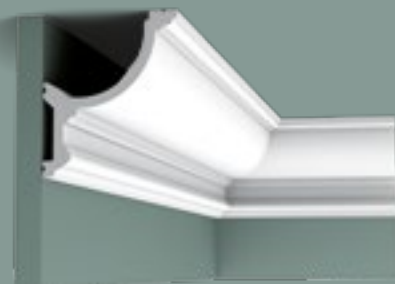
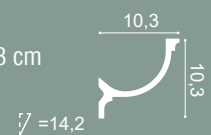

C901 | C901F
200 x 14,8 x 12,4 cm
Purotouch®

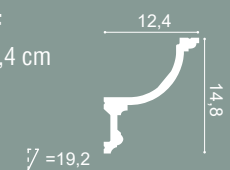

C900
200 x 17,1 x 14,6 cm
Purotouch®

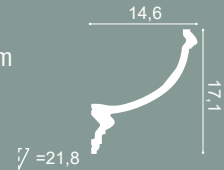

68



1. SX156 p.95 | 2. P8020 p.106

69



C305
200 x 4,7 x 15,5 cm
Purotouch®
15,5
4,7
5,6
∇ = 15,9

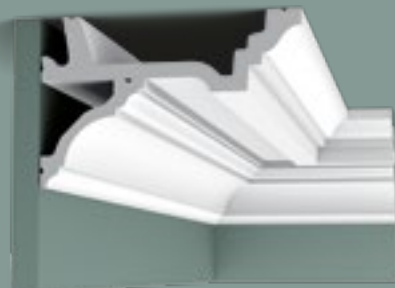

C305 + C213
15,5
4,7
8
5,6
∇ = 19,3



C305 + C211
15,5
4,7
11,6
11,2
5,6
∇ = 21,5



C212
200 x 7,5 x 4,5 cm
Purotouch®
4,5
7,5
∇ = 8,5



C201
200 x 11,6 x 4,8 cm
Purotouch®
4,8
11,6
∇ = 12,5



C304 | C304F
200 x 12,2 x 7,2 cm
Purotouch®
7,2
12,2
∇ = 13,9



C211 | C211F
200 x 11,6 x 11,2 cm
Purotouch®
11,2
11,6
∇ = 15,8



C422
200 x 16,4 x 19,4 cm
Purotouch®
19,4
16,4
∇ = 25,4



C303
200 x 14,4 x 6,5 cm
Purotouch®
6,5
14,4
∇ = 15,3



4 C219
200 x 17,6 x 13 cm
Purotouch®
13
17,6
∇ = 21,8

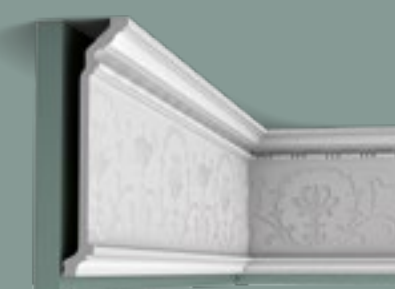

C308
200 x 24,8 x 6,3 cm
Purotouch®
6,3
24,8
∇ = 25

70



C307
200 x 19,5 x 19,5 cm
Purotouch®
19,5
19,5
∇ = 26,5

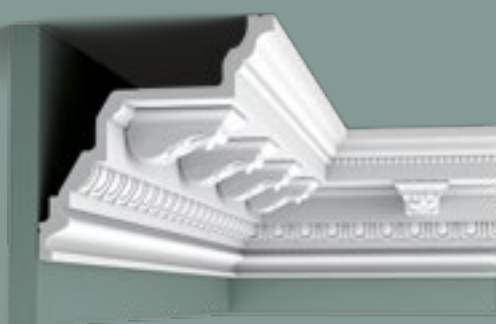

1 C307 + C307A 2
C307A: 7,5 x 4 x 9,4
Duropolymer®
19,5
9,4
4
5,6
∇ = 26,9

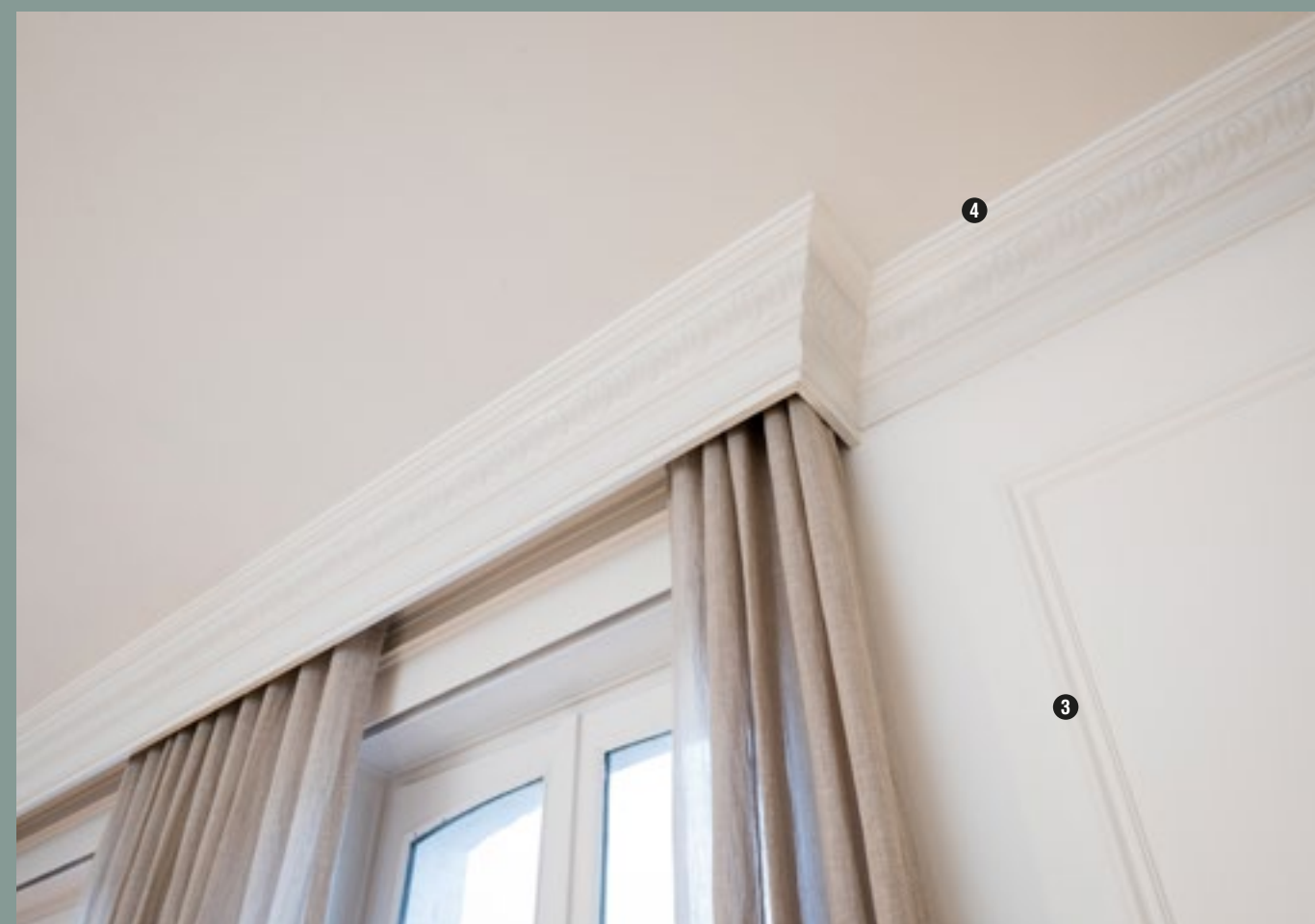

71



C321 | C321F
200 x 9,9 x 5 cm
Purotouch®

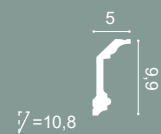

C339 | C339F
200 x 14,1 x 6,4 cm
Purotouch®

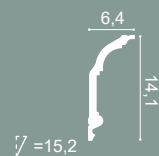

4 C332
200 x 23 x 11,4 cm
Purotouch®

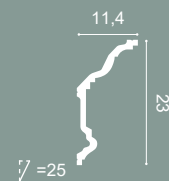

C332
200 x 11,4 x 23 cm
Purotouch®



C340
200 x 25,6 x 13,5 cm
Purotouch®

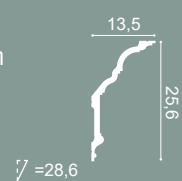

C340
200 x 13,5 x 25,6 cm
Purotouch®

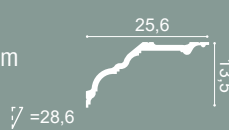

72



73

1. SX156 p.95 | 2. DX170-2300 p.150 | 3. C323 p.132

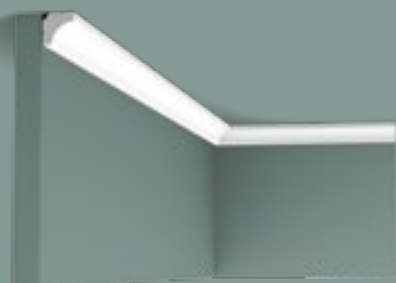

C250 | C250F
200 x 1,6 x 1,6 cm
Purotouch®

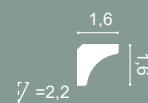

C260
200 x 4,1 x 4,8 cm
Purotouch®

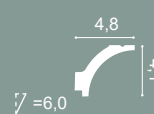

C240 | C240F
200 x 8 x 8 cm
Purotouch®

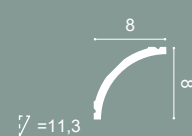

C991
200 x 11 x 14 cm
Purotouch®
Designed by Ulf Moritz

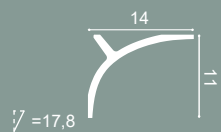

C991 + P9900

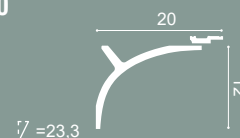

C991 + 2x P9900

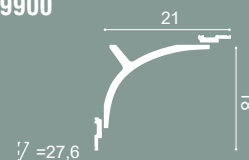

C991
200 x 14 x 11 cm
Purotouch®
Designed by Ulf Moritz

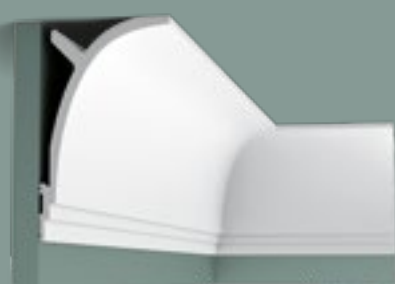
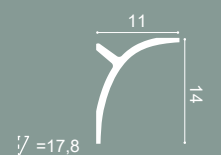

C991 + P9900



C991 + 2x P9900

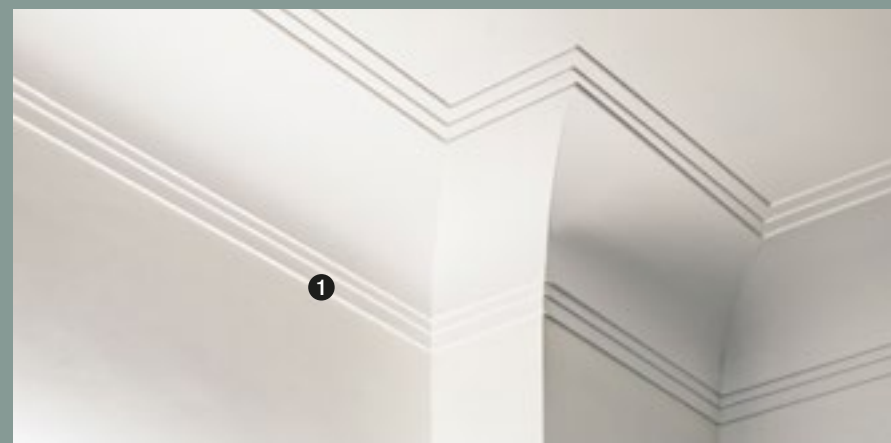
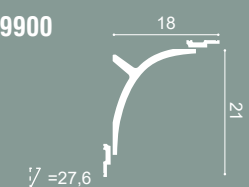

C990 INFINITY
200 x 15,9 x 21,6 cm
Purotouch®
Designed by Xavier Donck

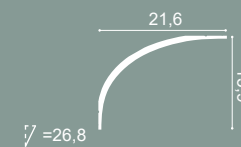

C990 INFINITY
200 x 21,6 x 15,9 cm
Purotouch®
Designed by Xavier Donck

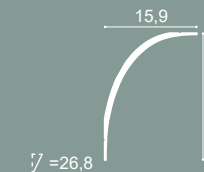

C990 + P9900

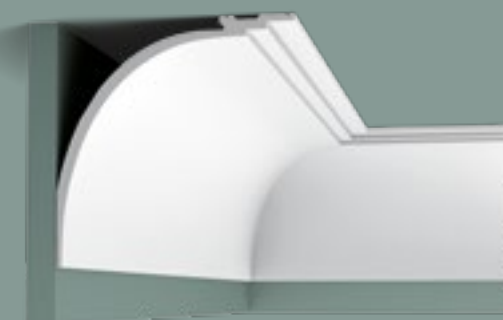
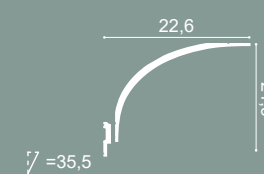

C990 + P9900

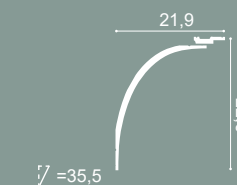

C990 + 2x P9900

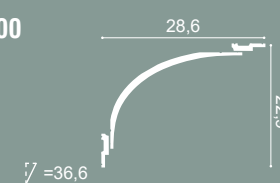

C990 + 2x P9900

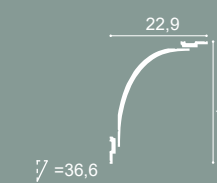

Steps



CORNICE MOULDINGS | CORNICI SOFFITTO | SANCAS | CORNISE | STROPNÍ LIŠTY

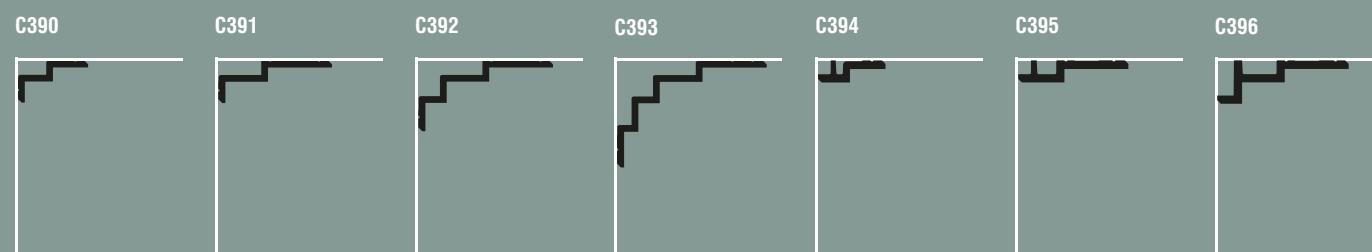

76 BORDER

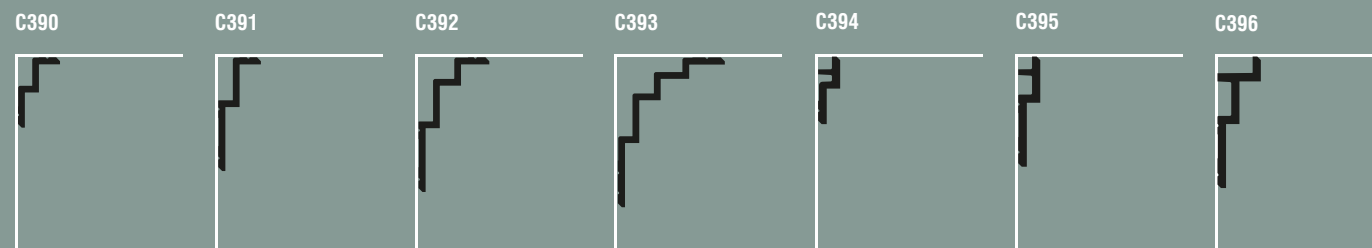

CURTAIN PROFILES | CORNICI PER TENDE | SANCAS PARA CORTINADOS | SINELE DE PERDEA | GARNYŽOVÉ PROFILY

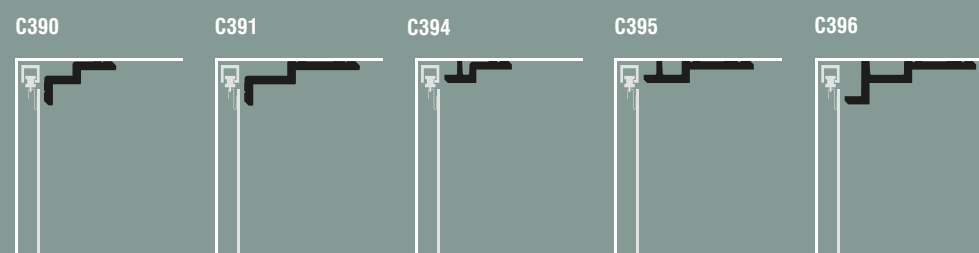

INDIRECT LIGHTING | ILLUMINAZIONE INDIRETTA | ILUMINAÇÃO INDIRETA | ILUMINATUL INDIRECT | NEPŘÍMÉ OSVĚTLENÍ

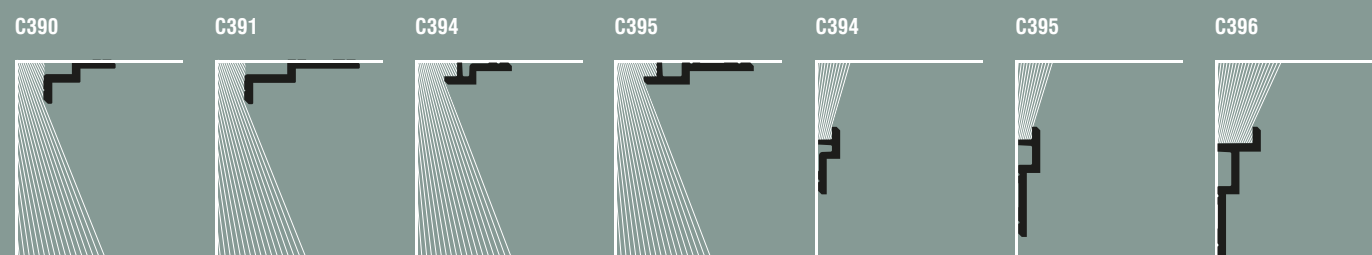

DOWNLIGHTER

UPLIGHTER



C394 STEPS

200 x 3,1 x 9,5 cm
Purotouch®
Designed by Orio Tonini

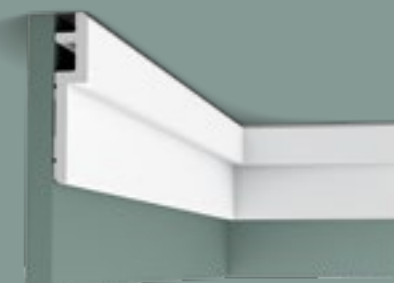

C395 STEPS

200 x 3,1 x 15,5 cm
Purotouch®
Designed by Orio Tonini

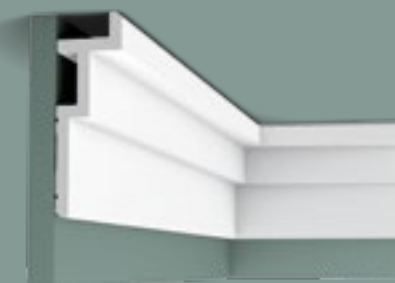

C396 STEPS

200 x 6,1 x 18,5 cm
Purotouch®
Designed by Orio Tonini

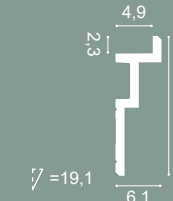

C390 STEPS

200 x 6 x 10 cm
Purotouch®
Designed by Orio Tonini

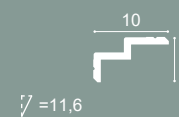

C391 STEPS

200 x 6 x 16 cm
Purotouch®
Designed by Orio Tonini

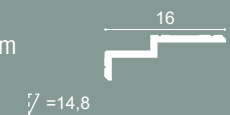

C392 STEPS

200 x 10 x 19 cm
Purotouch®
Designed by Orio Tonini



1 C393 STEPS

200 x 15 x 21 cm
Purotouch®
Designed by Orio Tonini

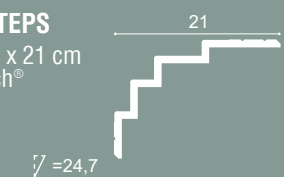

77



3 C360
200 x 2,1 x 6 cm
Purotouch®
Designed by
Jacques Vergracht



C356
200 x 2 x 10 cm
Purotouch®
Designed by
Jacques Vergracht



C355
200 x 3,5 x 11,1 cm
Purotouch®
Designed by
Jacques Vergracht



5 C353
200 x 3 x 16,5 cm
Purotouch®
Designed by
Jacques Vergracht



C354
200 x 4 x 21,5 cm
Purotouch®
Designed by
Jacques Vergracht



C602
200 x 5,3 x 5 cm
Purotouch®

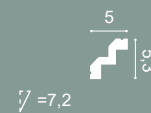

C400
200 x 6 x 10 cm
Purotouch®



Curtain Profiles

PROFILI PER TENDE / SANCAS PARA CORTINADOS
CORNISE PENTRU PERDELE / GARNÝŽOVÉ PROFILY



C394 STEPS CURTAIN PROFILE
200 x 3,1 x 9,5 cm
Purotouch®
Designed by Orio Tonini



C395 STEPS CURTAIN PROFILE
200 x 3,1 x 15,5 cm
Purotouch®
Designed by Orio Tonini

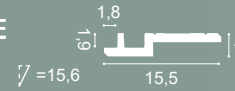

C390 STEPS CURTAIN PROFILE
200 x 6 x 10 cm
Purotouch®
Designed by Orio Tonini



C391 STEPS CURTAIN PROFILE
200 x 6 x 16 cm
Purotouch®
Designed by Orio Tonini

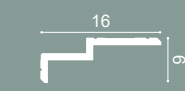

C396 STEPS CURTAIN PROFILE
200 x 6,1 x 18,5 cm
Purotouch®
Designed by Orio Tonini

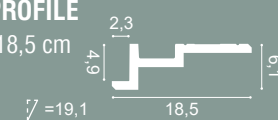

C991 CURTAIN PROFILE
200 x 11 x 14 cm
Purotouch®
Designed by Ulf Moritz



C341 | C341F HERITAGE CURTAIN PROFILE
200 x 8,8 x 12,2 cm
Purotouch®

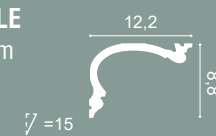

C342 HERITAGE CURTAIN PROFILE
200 x 14 x 19 cm
Purotouch®

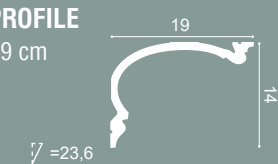

C343 HERITAGE CURTAIN PROFILE
200 x 19 x 25 cm
Purotouch®

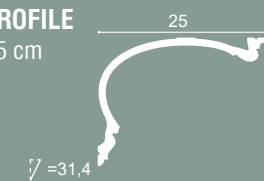

C340 CURTAIN PROFILE
200 x 13,5 x 25,6 cm
Purotouch®

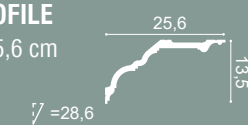



CX124 | CX124F
200 x 4,9 x 4,9 cm
Duropolymer®



CX100 | CX100F
200 x 6,9 x 7,1 cm
Duropolymer®



CX123 | CX123F
200 x 8 x 8 cm
Duropolymer®

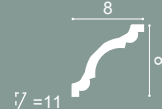

CX101
200 x 6,9 x 7,1 cm
Duropolymer®

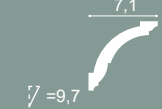

5 CX127 | CX127F
200 x 9,4 x 9,4 cm
Duropolymer®

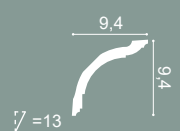

CX106 | CX106F
200 x 11,8 x 11,7 cm
Duropolymer®



CX111
200 x 2,6 x 1,5 cm
Duropolymer®

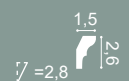

CX154
200 x 3 x 3 cm
Duropolymer®

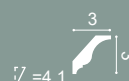

CX110 | CX110F
200 x 4,5 x 4,1 cm
Duropolymer®

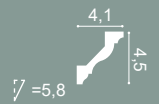

CX108
200 x 5,4 x 5,5 cm
Duropolymer®

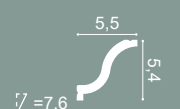

CX112
200 x 5,4 x 3,8 cm
Duropolymer®



CX177
200 x 7 x 6 cm
Duropolymer®



CX129
200 x 9,4 x 9,4 cm
Duropolymer®



CX128
200 x 9,4 x 9,4 cm
Duropolymer®

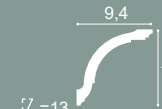

CX107
200 x 11,8 x 11,7 cm
Duropolymer®

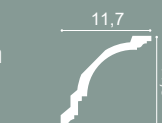

1. SX137 p.94 | 2. PX116 p.111 | 3. PX120 p.111 | 4. PX103 p.111



CX133
200 x 2 x 2 cm
Duropolymer®

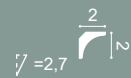

CX132 | CX132F
200 x 2 x 2 cm
Duropolymer®

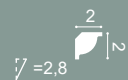

CX115
200 x 3 x 2,9 cm
Duropolymer®

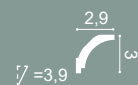

CX109 | CX109F
200 x 4,4 x 4,4 cm
Duropolymer®

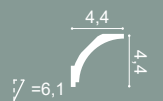

CX126
200 x 8,7 x 8,7 cm
Duropolymer®

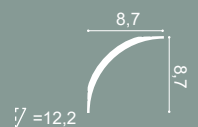

CX148
200 x 4,3 x 2,9 cm
Duropolymer®

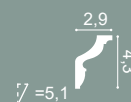

CX141
200 x 5,9 x 3,1 cm
Duropolymer®

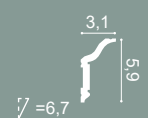

CX176
200 x 8 x 4 cm
Duropolymer®

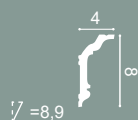

CX192
200 x 12 x 6 cm
Duropolymer®

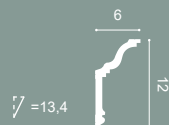

84



85

NEW



SX194 | SX194F SQUARE
200 x 1 x 2 cm
Duropolymer®



CX190 | CX190F U-PROFILE
200 x 3 x 2 cm
Duropolymer®
Designed by
Orio Tonini

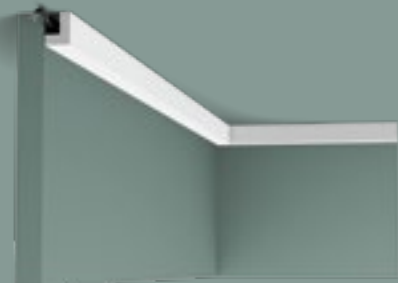

PX164
200 x 3 x 2,4 cm
Duropolymer®



SX162 | SX162F SQUARE
200 x 1 x 4 cm
Duropolymer®



SX157 | SX157F SQUARE
200 x 1,3 x 6,6 cm
Duropolymer®



SX163 | SX163F SQUARE
200 x 1,3 x 10,2 cm
Duropolymer®



SX182 | SX182F CASCADE
200 x 1,3 x 5 cm
Duropolymer®



SX183 | SX183F CASCADE
200 x 1,3 x 7,5 cm
Duropolymer®

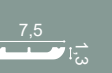

SX184 | SX184F CASCADE
200 x 1,3 x 11 cm
Duropolymer®



CX160
200 x 1,3 x 3,9 cm
Duropolymer®



CX161
200 x 1,3 x 6,9 cm
Duropolymer®



PB513
200 x 1,5 x 3,4 cm
Durofoam®



CB500
200 x 2,5 x 1,8 cm
Durofoam®



CB530
200 x 2,7 x 1,5 cm
Durofoam®



CB520
200 x 3,5 x 3,5 cm
Durofoam®



CB510
200 x 4 x 4 cm
Durofoam®



CB501
200 x 4,1 x 3,5 cm
Durofoam®



CB531
200 x 4,8 x 2,6 cm
Durofoam®



CB521
200 x 5 x 5 cm
Durofoam®

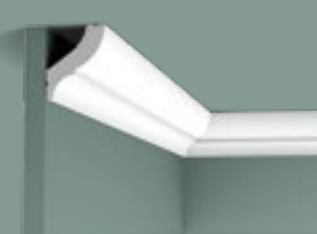

CB502
200 x 5,9 x 4,9 cm
Durofoam®



CB523
200 x 5,9 x 4,4 cm
Durofoam®



CB525
200 x 6,5 x 6 cm
Durofoam®



CB511
200 x 6,7 x 6,7 cm
Durofoam®



CB522
200 x 6,7 x 6,7 cm
Durofoam®



CB503
200 x 8,2 x 9,2 cm
Durofoam®



CB524
200 x 9 x 9 cm
Durofoam®



CB512
200 x 9,5 x 10 cm
Durofoam®



Skirting

BATTISCOPIA / RODAPÉS
PLINTE / PODLAHOVÉ LIŠTY



88

89

en —

Modern or rustic. Large or small. Striking or discrete. Whatever your style, you'll find the skirting your home deserves in a design you'll love. Looking for a hassle-free solution? Our superior Duropolymer[®] quality is fully impact- and water-resistant.

it —

Moderno o rustico. Grande o piccolo. Straordinario o discreto. Qualunque sia il tuo stile, troverai il battiscopa ideale per la tua casa, in un design che adorerai. Cerchi una soluzione facile? La nostra eccellente qualità Duropolymer[®] è completamente resistente agli urti e all'acqua.

pt —

Moderno ou rústico. Grande ou pequeno. Surpreendente ou discreto. Seja qual for o seu estilo, encontrará o rodapé perfeito para si. Procura uma solução sem complicações? A nossa qualidade superior Duropolymer[®] é totalmente resistente ao impacto e à água.

ro —

Modern sau rustic. Mare sau mic. Intens sau discret. Indiferent de stilul pe care îl adoptați, veți găsi plinta perfectă pentru locuința dumneavoastră, într-un design pe care îl veți adora. Căutați o soluție fără bătăi de cap? Calitatea superioară a materialului nostru Duropolymer[®] oferă rezistență completă la impact și la apă.

cz —

Moderní nebo rustikální. Velký nebo malý. Nápadný nebo diskrétní. Ať už je váš styl jakýkoli, najdete tu správnou podlahovou lištu, kterou si váš domov zaslouží, a v designu, který si zamilujete. Hledáte jednoduché řešení? Náš vysoce kvalitní materiál Duropolymer[®] je zcela odolný vůči nárazům a vodě.

DUROPOLYMER®

LOVES...

it —

Duropolymer® ama la vernice, viene fornito primerizzato ed è facile da rifinire con qualsiasi tipo di vernice di qualità. Duropolymer® ama l'acqua, ma non si bagna mai, è impermeabile e ha dimensioni stabili. Duropolymer® ama distinguersi con bordi definiti e dettagli raffinati per un design ad alta definizione. Duropolymer® è resistente agli urti e ai graffi. Duropolymer® è leggero e facile da installare con le colle Orac Decor DecoFix. Duropolymer® ama la sostenibilità, è prodotto con riciclaggio integrato, è riciclabile al 100% e non contiene prodotti tossici.

pt —

O Duropolymer® adora tinta, é fornecido com pré-pintura e é de fácil acabamento com qualquer tipo de tinta de qualidade. O Duropolymer® adora água, mas nunca fica húmido, é resistente à água e dimensionalmente estável. O Duropolymer® adora destacar-se em arestas pontiagudas e detalhes finos para um design de alta definição. O Duropolymer® adora o trabalho árduo e é resistente às pancadas, impactos e riscos. O Duropolymer® adora deambular, é leve e fácil de instalar com as colas Orac Decor DecoFix. O Duropolymer® adora a sustentabilidade, é produzido com reciclagem integrada, é 100% reciclável e não contém produtos tóxicos.

ro —

Duropolymer® adoră vopsea, are grundul deja aplicat și este ușor de finisat cu orice tip de vopsea de calitate. Duropolymer® adoră apa, dar nu se umezește niciodată, este rezistent la apă și stabil dimensional. Duropolymer® adoră să iasă în evidență, cu margini ascuțite și detalii fine pentru un design de înaltă definiție. Duropolymer® adoră să fie pus la treabă și rezistă la lovituri, impact și zgârieturi. Duropolymer® adoră să se integreze în designul general, are greutate redusă și este ușor de montat cu adezivii Orac Decor DecoFix. Duropolymer® adoră sustenabilitatea, iar modul său de fabricație integrează principiile de mediu, deci este 100% reciclabil și nu conține produse toxice.

cz —

Duropolymer® má rád barvy, dodáváme ho se základním nátěrem, na který se snadno nanáší jakýkoli druh kvalitní barvy. Duropolymer® miluje vodu, ale nikdy nevlhne, je voděodolný a rozměrově stálý. Duropolymer® sluší ostré hrany s jemnými detaily pro design s vysokým rozlišením. Duropolymer® miluje tvrdou práci a je odolný vůči nárazům a poškrábání. Duropolymer® rád visí, je lehký a snadno se instaluje pomocí lepidel Orac Decor DecoFix. Duropolymer® miluje udržitelnost, při jeho výrobě se používá integrovaná recyklace, je 100% recyklovatelný a neobsahuje žádné toxické produkty.



PAINT

primed and easy to finish with any type of quality paint

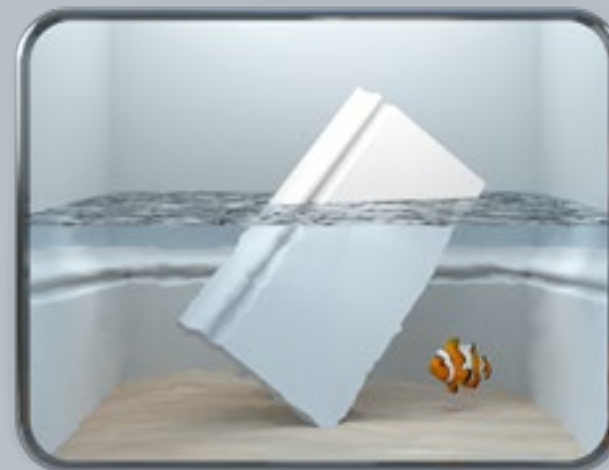

WATER

but never gets wet; water resistant and dimensionally stable



TO STAND OUT

sharp edges and fine details for high-definition design



HARD WORK

knock-, impact- and scratch-resistant



TO HANG AROUND

light-weight and easy to install with Orac Decor DecoFix glues



SUSTAINABILITY

produced with 40% renewable energy, 100% recyclable, contains no toxic products

3 essential skirting families

CHOOSE YOUR STYLE. GET CREATIVE.

it —

3 famiglie di battiscopa essenziali. Scegli il tuo stile. Esprimi la tua creatività.

pt —

3 famílias de rodapés essenciais. Escolha o seu estilo. Seja criativo.

ro —

3 familii de plinte esențiale. Alegeți stilul.

cz —

3 rodiny podlahových lišt. Vyberte si svůj styl. Buďte kreativní.



1. SX118 p.93 | 2. P4020 p.106 | 3. P8030 p.106 | 4. C339 p.72

SQUARE



CASCADE



CONTOUR



SMALL

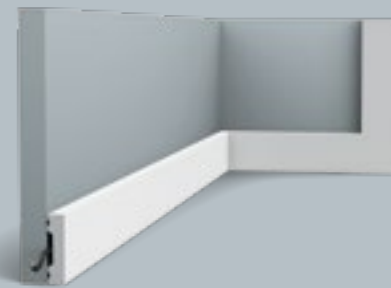

SX162 | SX162F
SQUARE
200 x 4 x 1 cm
Duropolymer®

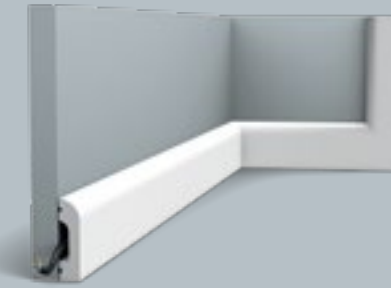

SX182 | SX182F CASCADE
200 x 5 x 1,3 cm
Duropolymer®

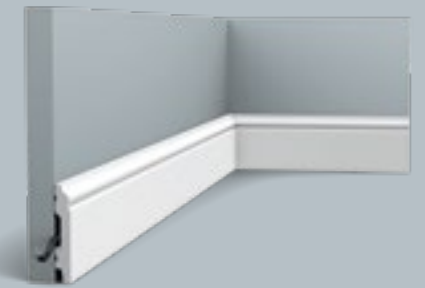

SX165 | SX165F CONTOUR
200 x 6,9 x 1,1 cm
Duropolymer®



MEDIUM

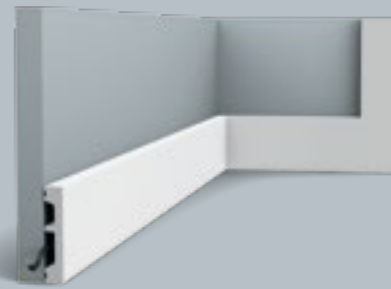

SX157 | SX157F | SX157-RAL9003
SQUARE
200 x 6,6 x 1,3 cm
Duropolymer®

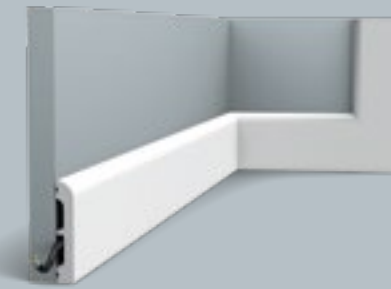

SX183 | SX183F | SX183-RAL9003
CASCADE
200 x 7,5 x 1,3 cm
Duropolymer®

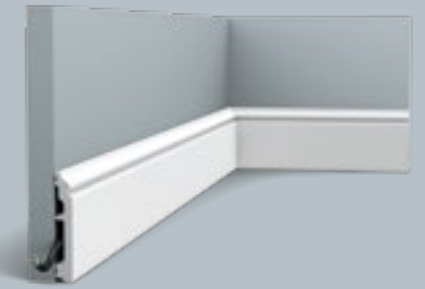

SX173 | SX173F | SX173-RAL9003
CONTOUR
200 x 10 x 1,6 cm
Duropolymer®



BIG

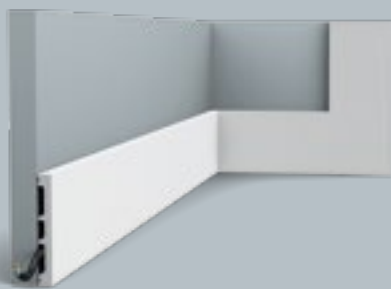

SX163 | SX163F | SX163-RAL9003
SQUARE
200 x 10,2 x 1,3 cm
Duropolymer®

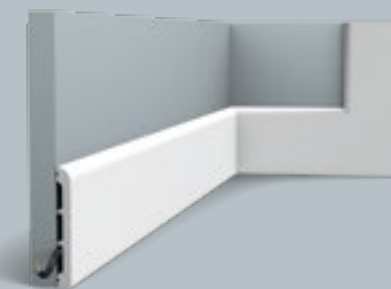

SX184 | SX184F | SX184-RAL9003
CASCADE
200 x 11 x 1,3 cm
Duropolymer®

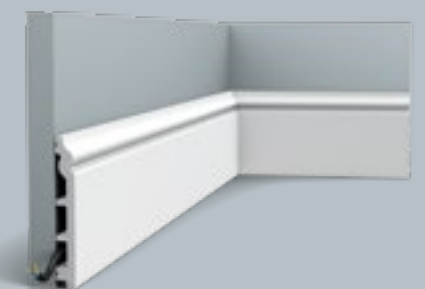

SX118 | SX118F | SX118-RAL9003
CONTOUR
200 x 13,8 x 1,8 cm
Duropolymer®



COVER

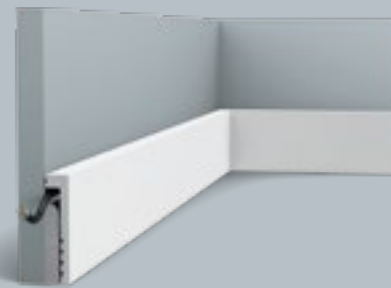

SX171 SQUARE
200 x 10 x 2,2 cm
Duropolymer®

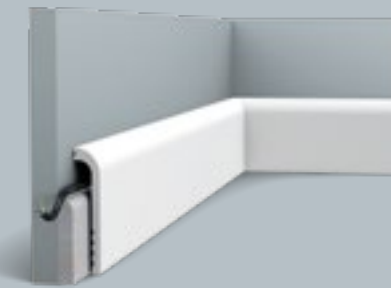

SX185 CASCADE
200 x 12 x 2,5 cm
Duropolymer®

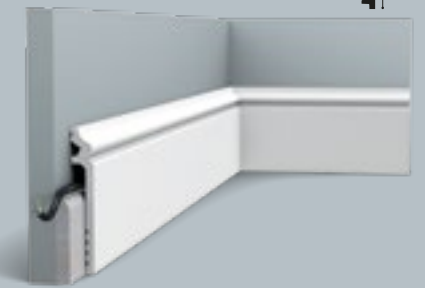

SX186 CONTOUR
200 x 13,8 x 2,2 cm
Duropolymer®





2. W120 p.126

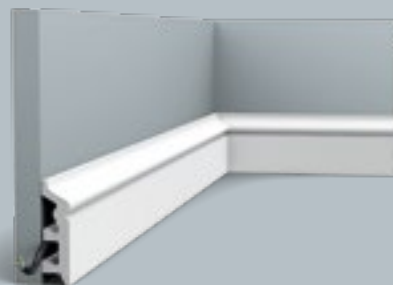

SX122
200 x 7,9 x 2,2 cm
Duropolymer®

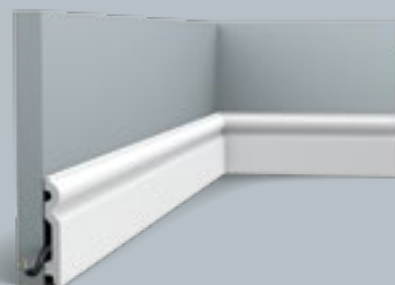

SX137 | SX137F
200 x 9,9 x 1,5 cm
Duropolymer®

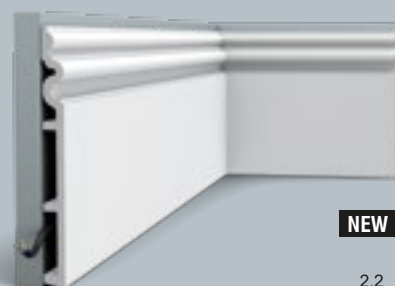

NEW

1 SX193 AUTOIRE
200 x 25 x 2,2 cm
Duropolymer®
Designed by
Orio Tonini

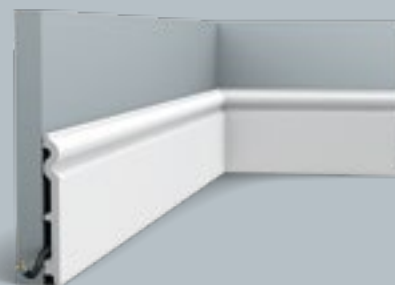

SX138 | SX138F
200 x 13,8 x 1,5 cm
Duropolymer®



SX104 | SX104F
200 x 14,8 x 1,7 cm
Duropolymer®



SX156 HIGH HEELS
200 x 20,2 x 1,6 cm
Duropolymer®
Designed by
Xavier Donck



3 SX191 HIGH RISE
200 x 21 x 2,1 cm
Duropolymer®



4. PX175 p.111 | 5. DX174-2300 p.110 | 6. DX170-2300 p.150



96

2. P8030 p.106 | 3.W113 p.122



SX187 | SX187F HIGH LINE
200 x 7,5 x 1,2 cm
Duropolymer®
Designed by
Pierre Daems



4 SX180 | SX180F HIGH LINE
200 x 12 x 1,6 cm
Duropolymer®
Designed by
Pierre Daems



SX181 HIGH LINE
200 x 20 x 2,2 cm
Duropolymer®
Designed by
Pierre Daems



97

Skirting | Battiscopa | Rodapés | Plinte | Podlahové lišty

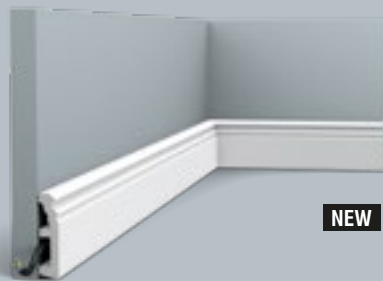

NEW

1 SX195 | SX195F HAMBURG
200 x 8 x 1,9 cm
Duropolymer®

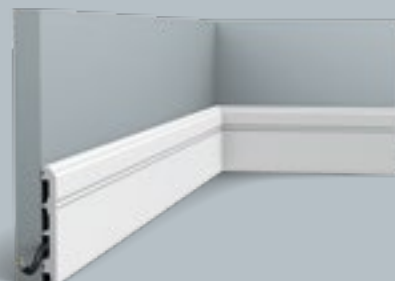

SX105 | SX105F
200 x 10,8 x 1,3 cm
Duropolymer®

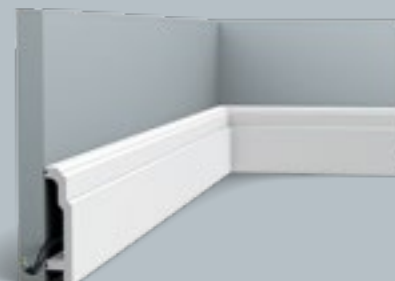

SX155 | SX155F
200 x 10,8 x 2,5 cm
Duropolymer®



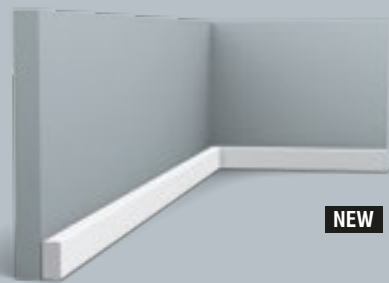

NEW

SX194 | SX194F SQUARE
200 x 2 x 1 cm
Duropolymer®

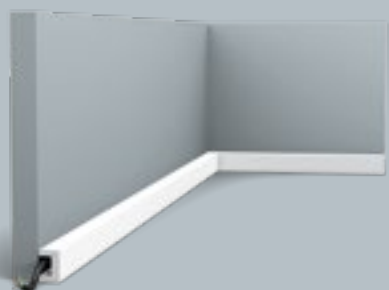

CX190 | CX190F U-PROFILE
200 x 3 x 2 cm
Duropolymer®
Designed by
Orio Tonini

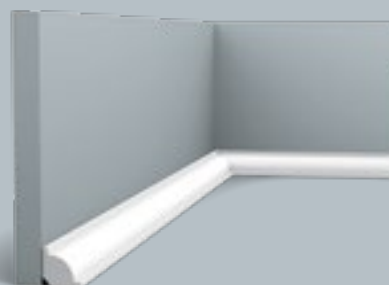

CX132 | CX132F
200 x 2 x 2 cm
Duropolymer®

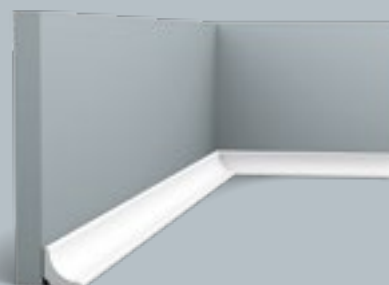

CX133
200 x 2 x 2 cm
Duropolymer®

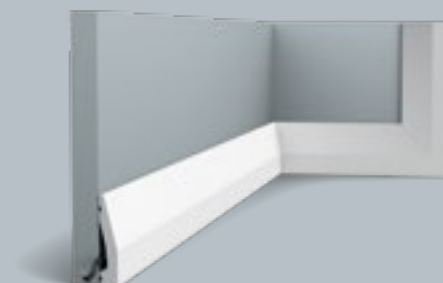

SX159
200 x 6 x 1,2 cm
Duropolymer®



SX125
200 x 6,9 x 1,4 cm
Duropolymer®

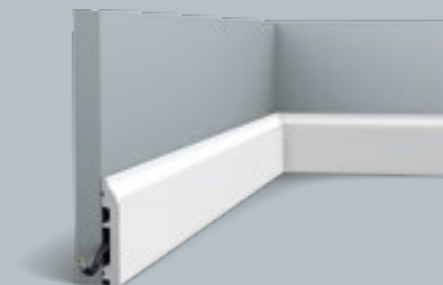

SX172 | SX172F
200 x 8,5 x 1,4 cm
Duropolymer®

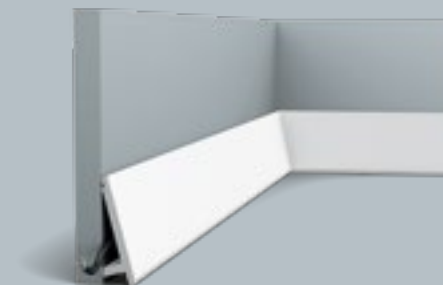

SX179 DIAGONAL
200 x 9,7 x 2,9 cm
Duropolymer®
Designed by
Orio Tonini

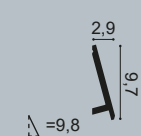

Cover Skirting

COPRI BATTISCOPIA / RODAPÉ DE SOBREPOSIÇÃO
PLINTA DE ACOPERIRE / KRYCÍ PODLAHOVÁ LIŠTA

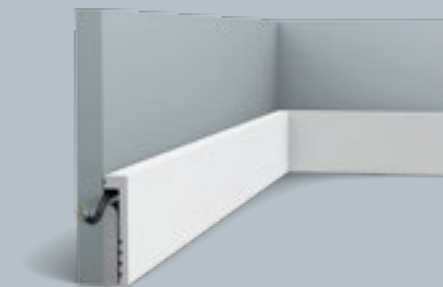

SX171 SQUARE
200 x 10 x 2,2 cm
Duopolymer[®]

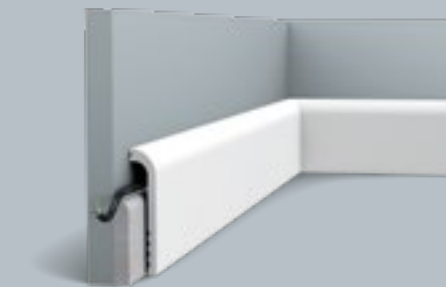
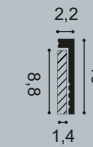

SX185 CASCADE
200 x 12 x 2,5 cm
Duopolymer[®]

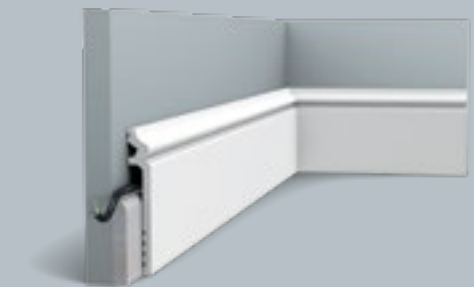
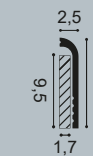

SX186 CONTOUR
200 x 13,8 x 2,2 cm
Duopolymer[®]

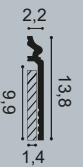

PAINTABLE
Verniciabile
Pintável
Vopsibil
Přetřítelné

WATER RESISTANT
Resistente all'acqua
Resistente à água
Rezistent la apă
Voděodolné

IDEAL FOR RENOVATIONS
Ideale per le ristrutturazioni
Ideal para renovações
Ideal pentru renovări
Ideální pro renovace



6. PX175 p.111

Multifunctional

MULTIFUNZIONALE / MULTIFUNCIONAL
MULTIFUNȚIONAL / MULTIFUNKČNÍ

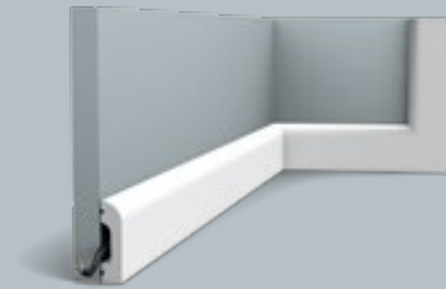

SX182 | SX182F CASCADE
200 x 5 x 1,3 cm
Duropolymer®

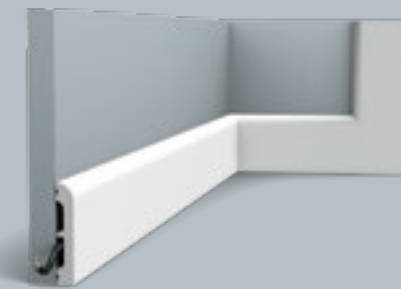

SX183 | SX183F CASCADE
200 x 7,5 x 1,3 cm
Duropolymer®

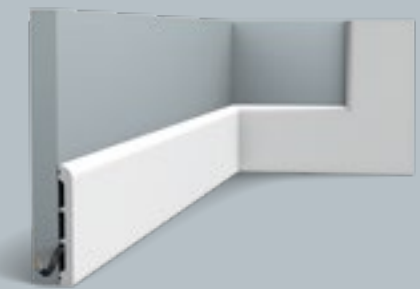

SX184 | SX184F CASCADE
200 x 11 x 1,3 cm
Duropolymer®

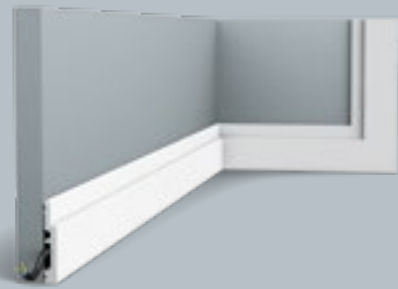

SX187 | SX187F HIGH LINE
200 x 7,5 x 1,2 cm
Duropolymer®
Designed by
Pierre Daems

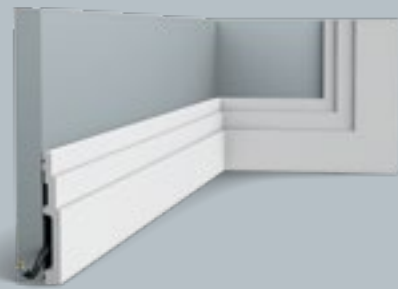

SX180 | SX180F HIGH LINE
200 x 12 x 1,6 cm
Duropolymer®
Designed by
Pierre Daems

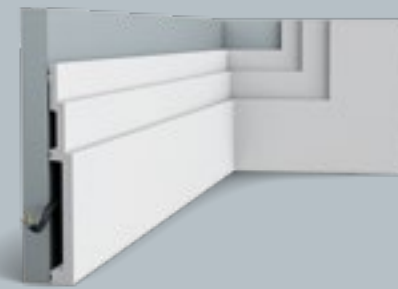

SX181 HIGH LINE
200 x 20 x 2,2 cm
Duropolymer®
Designed by
Pierre Daems

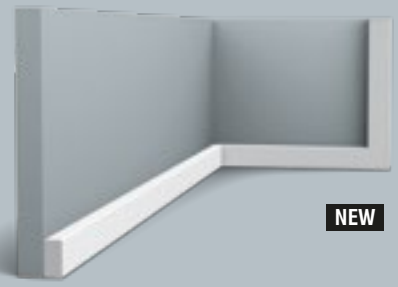

SX194 | SX194F SQUARE
200 x 2 x 1 cm
Duropolymer®

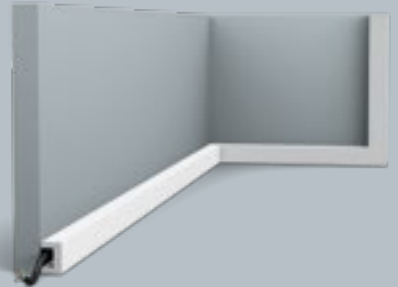

CX190 | CX190F U-PROFILE
200 x 3 x 2 cm
Duropolymer®
Designed by
Orio Tonini

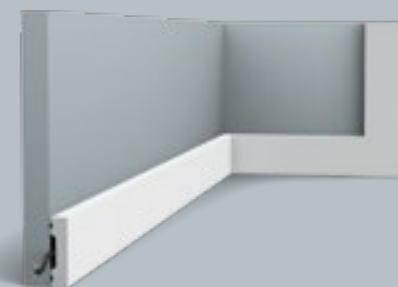

SX162 | SX162F SQUARE
200 x 4 x 1 cm
Duropolymer®

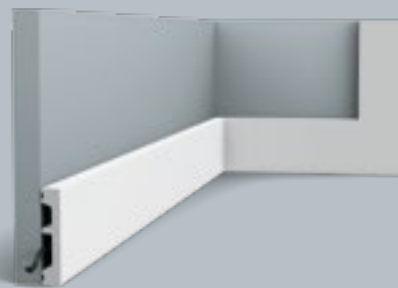

SX157 | SX157F SQUARE
200 x 6,6 x 1,3 cm
Duropolymer®

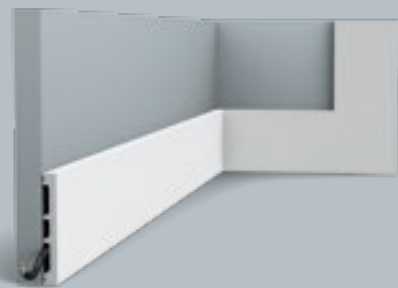

SX163 | SX163F SQUARE
200 x 10,2 x 1,3 cm
Duropolymer®

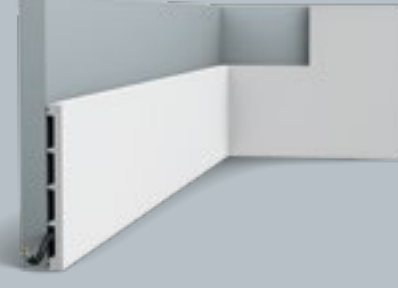

SX168 SQUARE
200 x 15,1 x 1,4 cm
Duropolymer®



1. SX105 p.96

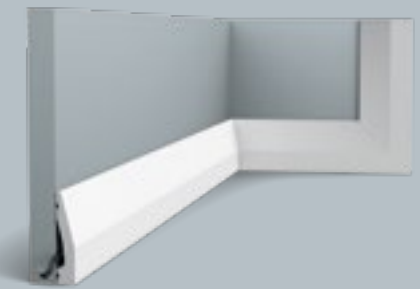

SX159
200 x 6 x 1,2 cm
Duropolymer®



en —

Profiles with endless possibilities. Each element can be used as a panel moulding, cornice moulding, door surround or as skirting board.

it —

Profili con infinite possibilità d'uso. Lo stesso elemento può essere utilizzato sia come cornice soffitto, cornice parete, contorno porta e come battiscopa.

pt —

Perfis com possibilidades infinitas. Cada elemento pode ser usado como moldura de painel, de sanca, de porta ou como rodapé.

ro —

Profile cu posibilități nesfârșite. Unul și același element poate fi folosit ca brau, cornisa, încadrământ de usa și ca plintă.

cz —

Profily s mnohostranným využitím. Ten samý prvek může být použit jako lemovací, stropní lišta, dveřní obložka tak i podlahová lišta..



Panel Mouldings

CORNICI PARETE / PERFIS
BRAURI / LEMOVACÍ LIŠTY



en —

Make your walls come to life by "wallscaping" them with panel mouldings. Integrating indirect lighting, visually changing ceiling height, adding character and bringing symmetry, our panel mouldings are the ideal addition to your home.

it —

Dai nuova vita alle tue pareti "ridimensionandole" con le cornici parete. Integrando l'illuminazione indiretta, cambiando visivamente l'altezza del soffitto, aggiungendo carattere e simmetria, i nostri pannelli sono il complemento ideale per la tua casa.

pt —

Dê vida às suas paredes, decorando-as com painéis. A integração da iluminação indireta, a alteração visual da altura do teto, a adição de caráter e de simetria fazem com que os nossos painéis sejam o complemento ideal para a sua casa.

ro —

Insuflați viață pereților creând o „peisagistică” pe aceștia, cu ajutorul profilelor de tip brau. Prin integrarea iluminării indirecte, prin schimbarea percepției vizuale a înălțimii tavanului, prin acel plus de caracter și prin crearea simetriei, profilele noastre pentru ancadramente reprezintă completarea ideală a locuinței dumneavoastră.

cz —

Oživte své stěny metodou „wallscaping” pomocí lemovacích lišt. Lemovací lišty jsou pro váš domov ideálním doplňkem – integrují nepřímé osvětlení, vizuálně mění výšku stropu, dodávají prostoru charakter a symetrii.



2 P8030 | P8030F
200 x 4,1 x 1,7 cm
Purotouch®

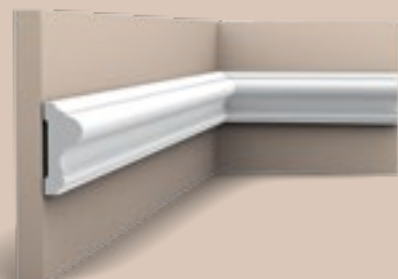

P8020 | P8020F
200 x 6 x 2,6 cm
Purotouch®



P8050 | P8050F
200 x 12 x 3 cm
Purotouch®

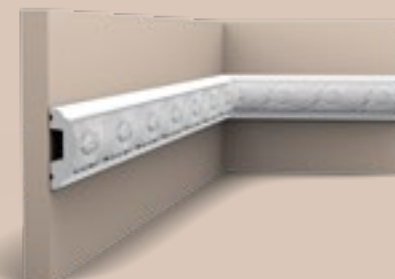

P1020
200 x 4,9 x 2,4 cm
Purotouch®

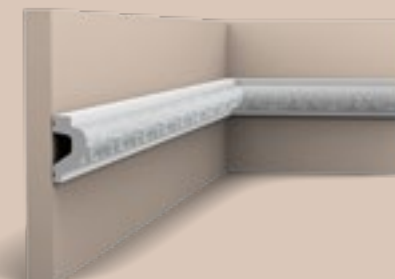

P3020 | P3020F
200 x 6,1 x 3,2 cm
Purotouch®

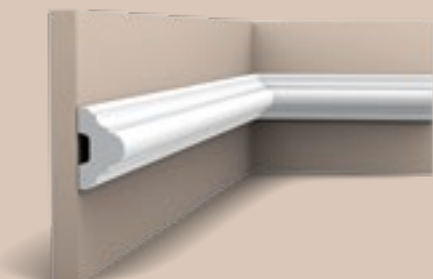

P4020 | P4020F
200 x 5 x 2,9 cm
Purotouch®

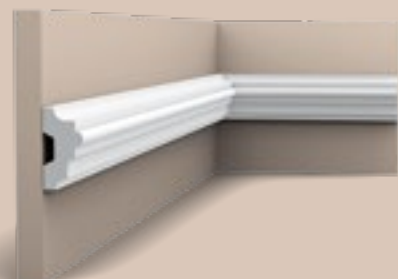

P9040
200 x 5 x 2,5 cm
Purotouch®



P9010 | P9010F
200 x 9,1 x 3 cm
Purotouch®

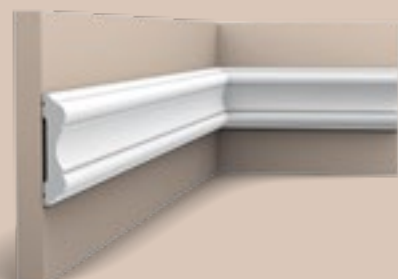

P8040 | P8040F
200 x 10,1 x 2,2 cm
Purotouch®

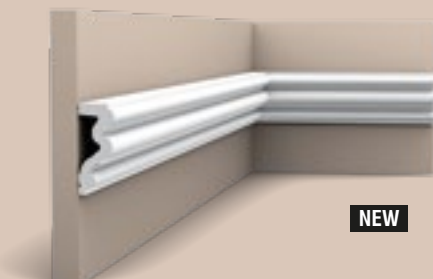

P4025 | P4025F AUTOIRE
200 x 8,3 x 3,4 cm
Purotouch®
Designed by
Orio Tonini



NEW

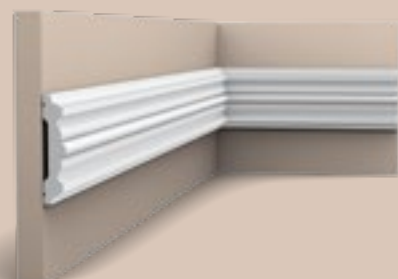

P9020
200 x 9,6 x 2,1 cm
Purotouch®

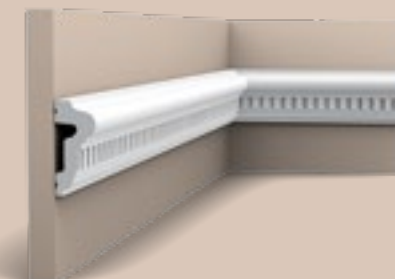
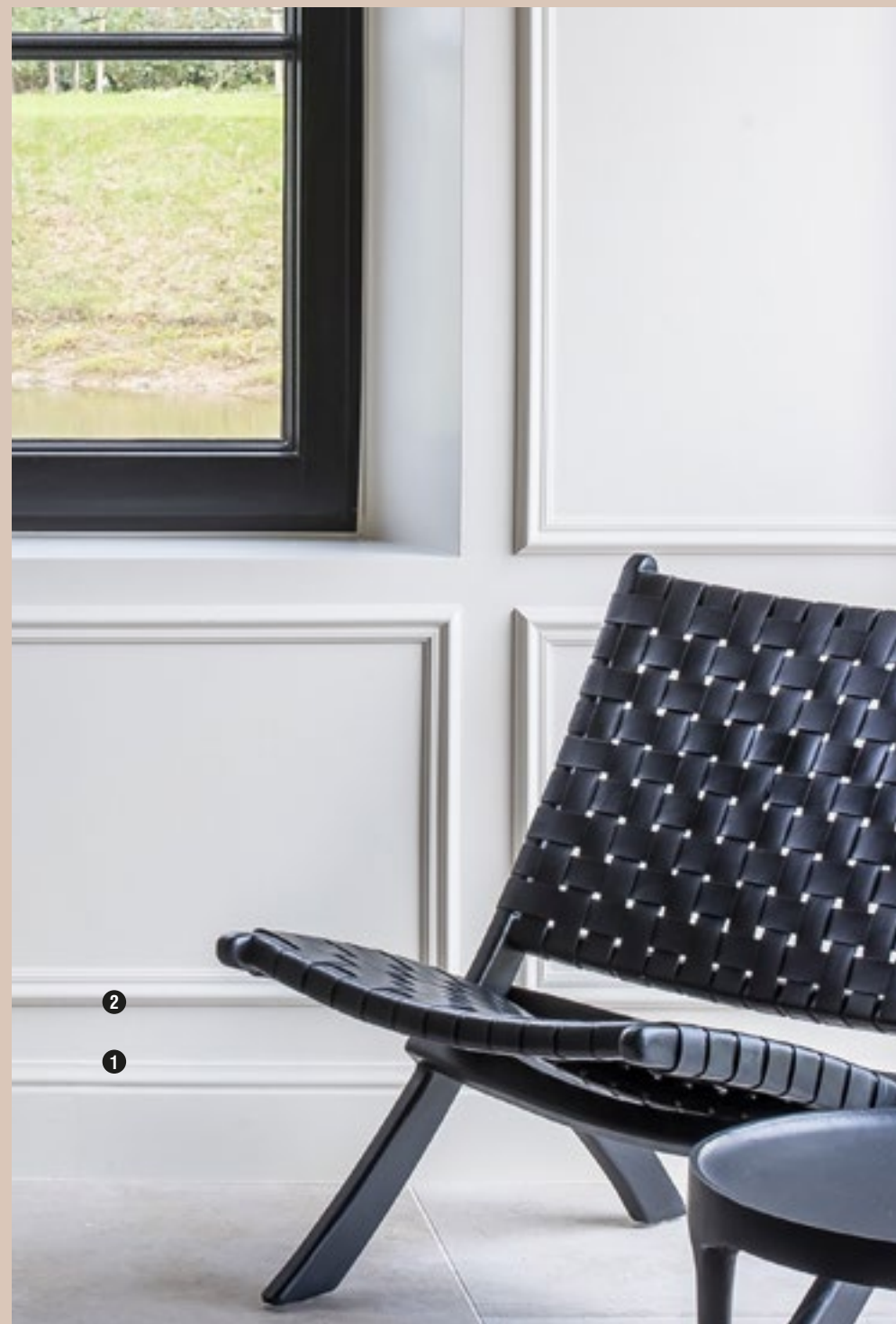

P6020
200 x 6,4 x 2,8 cm
Purotouch®

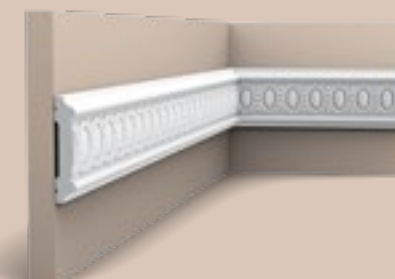

P7030
200 x 8,5 x 1,7 cm
Purotouch®



P7020
200 x 11,1 x 1,9 cm
Purotouch®



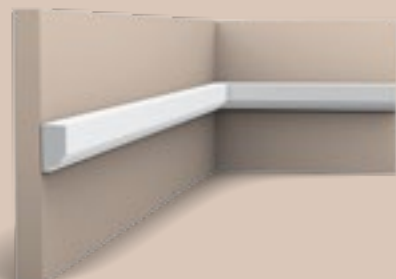

P9050 | P9050F
200 x 2,5 x 1,3 cm
Purotouch®

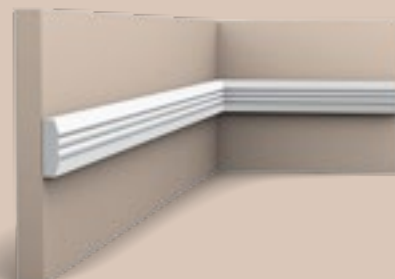

P5021 | P5021F
200 x 3,1 x 0,9 cm
Purotouch®

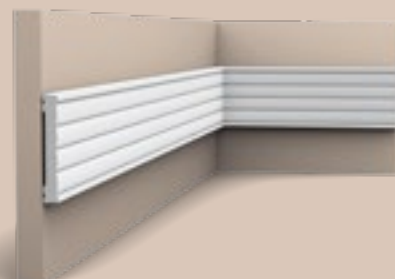

P5020
200 x 9,1 x 1,3 cm
Purotouch®

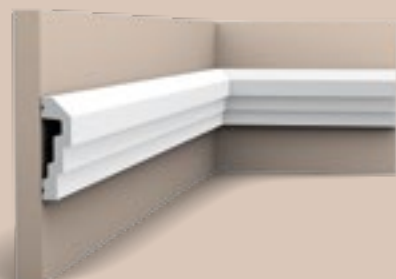

P7070 | P7070F
200 x 7,4 x 2,2 cm
Purotouch®

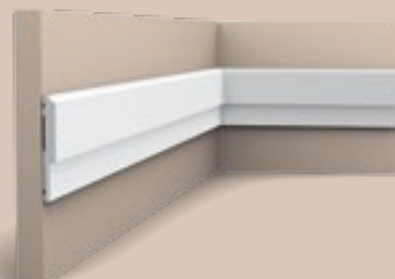

P9900 | P9900F
200 x 8 x 1 cm
Purotouch®

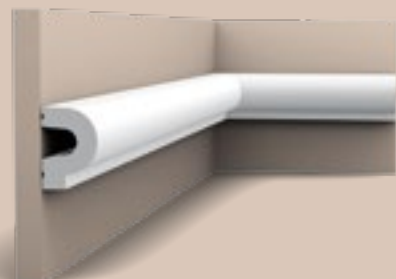

P8060
200 x 5 x 3,5 cm
Purotouch®

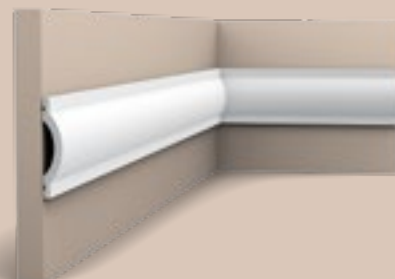

P9901
200 x 7 x 1,4 cm
Purotouch®

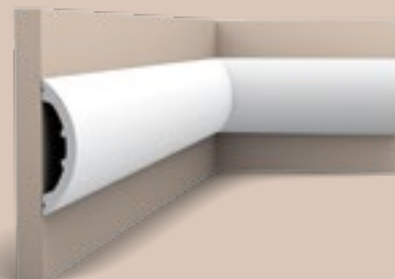

P3070 RADIUS
200 x 12,5 x 3,2 cm
Purotouch®
Designed by
Ulf Moritz



P3071 GOLF
200 x 37,2 x 7,6 cm
Purotouch®
Designed by
Ulf Moritz



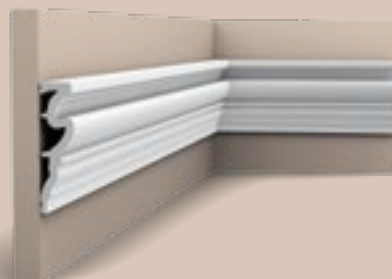
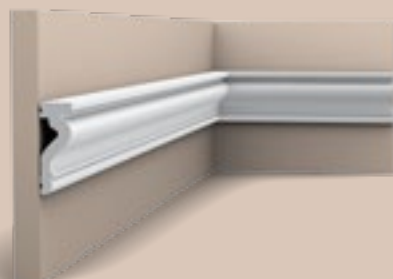

1 DX174-2300 | DX174F
230 x 6 x 2,2 cm (DX174-2300)
Duropolymer®
200 x 6 x 2,2 cm (DX174F)



DX170-2300
230 x 11,9 x 3,2 cm
Duropolymer®

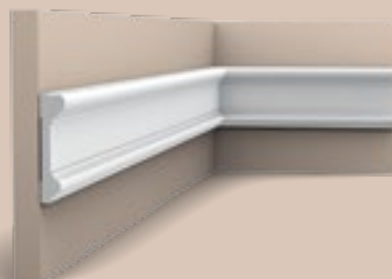
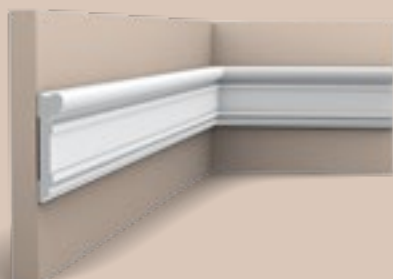
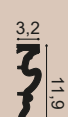

DX119-2300
230 x 9,2 x 2,2 cm
Duropolymer®



DX121-2300
230 x 9,4 x 2,3 cm
Duropolymer®

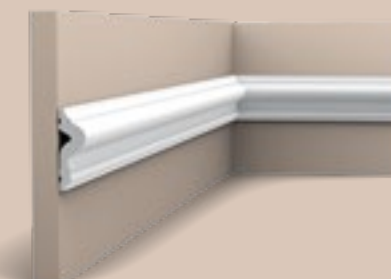
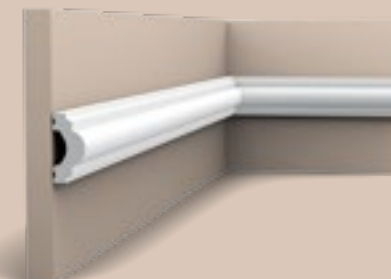
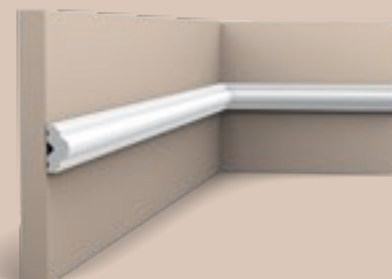

PX103 | PX103F
200 x 2,5 x 1,2 cm
Duropolymer®



PX120 | PX120F
200 x 4 x 1,9 cm
Duropolymer®



PX175 | PX175F
200 x 5 x 1,7 cm
Duropolymer®

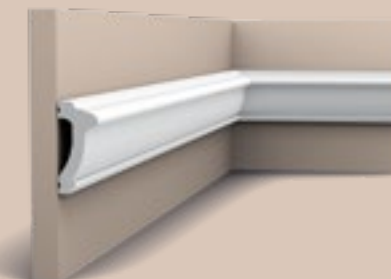
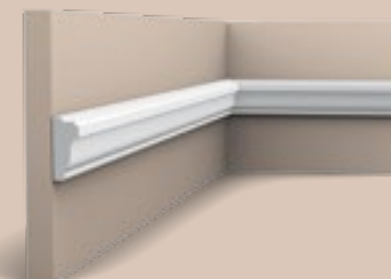
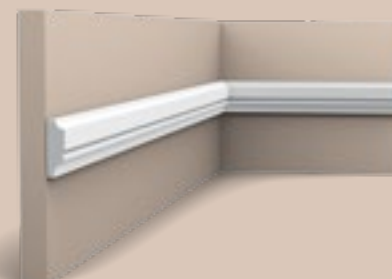

PX116
200 x 3,1 x 1 cm
Duropolymer®



PX117
200 x 3,5 x 1,5 cm
Duropolymer®



PX113
200 x 6 x 2,7 cm
Duropolymer®

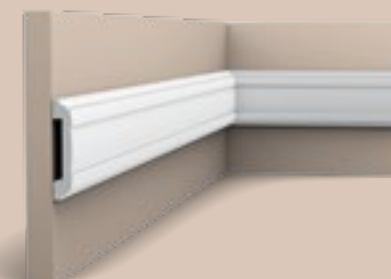

PX144 | PX144F
200 x 4,7 x 0,8 cm
Duropolymer®



PX102
200 x 7,9 x 1,6 cm
Duropolymer®

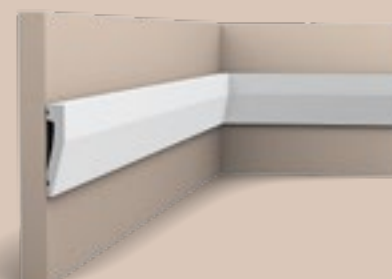

SX159
200 x 6 x 1,2 cm
Duropolymer®



1. SX191 p.95 | 3. W130 p.120

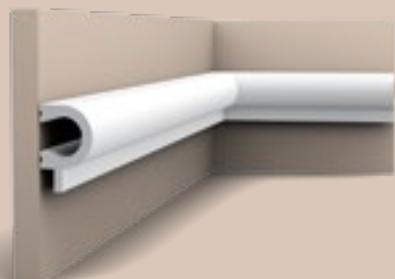

PX169 A
200 x 5,5 x 3,4 cm
Duropolymer®

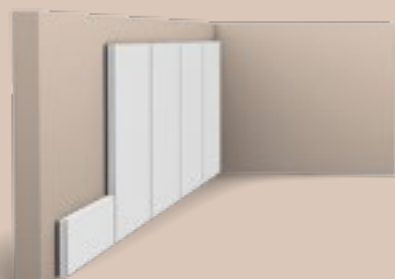

PX147 B
200 x 16,9 x 0,9 cm
Duropolymer®

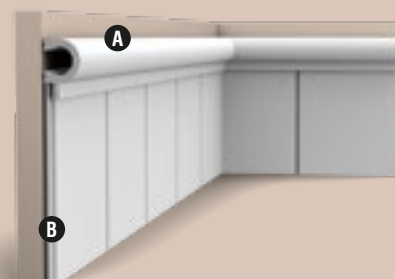

PX169 + PX147

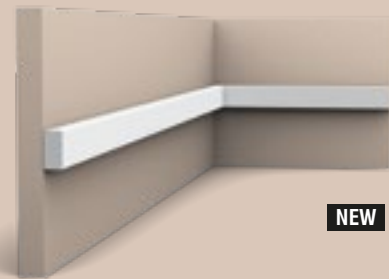

SX194 | SX194F SQUARE
200 x 2 x 1 cm
Duropolymer®

NEW



SX162 | SX162F SQUARE
200 x 4 x 1 cm
Duropolymer®

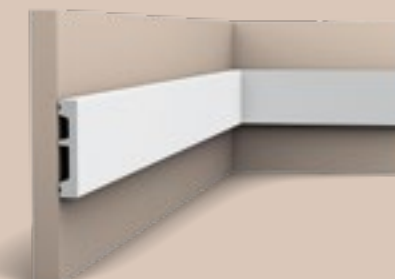

SX157 | SX157F SQUARE
200 x 6,6 x 1,3 cm
Duropolymer®



2

1

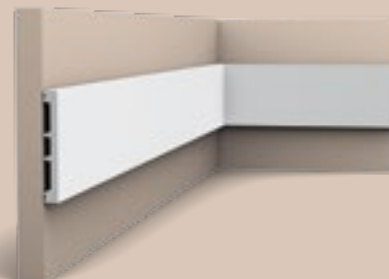

SX163 | SX163F SQUARE
200 x 10,2 x 1,3 cm
Duropolymer®



SX168 SQUARE
200 x 15,1 x 1,4 cm
Duropolymer®

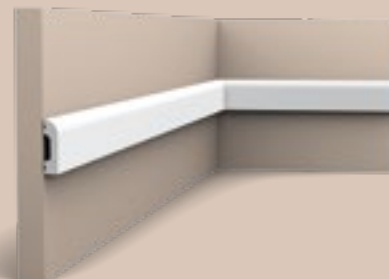

SX182 | SX182F CASCADE
200 x 5 x 1,3 cm
Duropolymer®



SX183 | SX183F CASCADE
200 x 7,5 x 1,3 cm
Duropolymer®



SX184 | SX184F CASCADE
200 x 11 x 1,3 cm
Duropolymer®



1. P8020 p.106 | 2. P4020 p.106

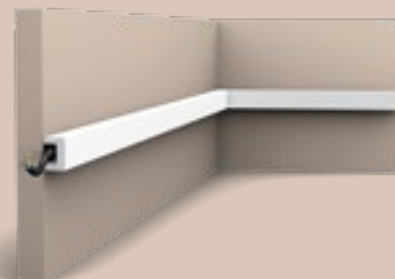

CX190 | CX190F U-PROFILE
200 x 3 x 2 cm
Duropolymer®
Designed by
Orio Tonini

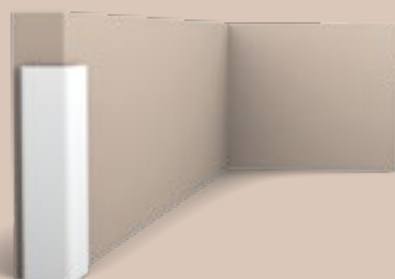

CX134
200 x 3 x 3 cm
Duropolymer®





1. PX120 p.111 | 2. SX156 p.95 | 4. P3020 p.107



P5020B + P5020
9 x 9 x 1,3 cm
Purotouch[®]



P101A + P1020
24,5 x 24,5 x 2,4 cm
Purotouch[®]



P801C + P8020
19,8 x 11 x 2,6 cm
Purotouch[®]



P4020A + P4020
16,4 x 9,1 x 2,9 cm
Purotouch[®]



3 P3020A + P3020
42,5 x 42,5 x 4 cm
Purotouch[®]



P20 + P101A
Ø 6,1 - 0,8 cm
Duropolymer[®]



PX103A + PX103
19 x 3,5 x 1,2 cm
Duropolymer[®]



P8030D + P8030
13,2 x 13,2 x 1,7 cm
Duropolymer[®]



P8030C + P8030
19 x 8,6 x 1,7 cm
Duropolymer[®]



PX120A + PX120
19 x 8,8 x 2 cm
Duropolymer[®]

3D Wall Covering

RIVESTIMENTO MURALE 3D
REVESTIMENTO DE PAREDE 3D
PANOURI DECORATIVE 3D
3D NÁSTĚNNÉ OBLOŽENÍ



en —

Modern and contemporary. Bold and outspoken. Textured and fascinating. What inspires you and your walls? Create an immediate wow effect with our 3D Wall Covering. From large 3D panels to classic shapes, we have a range of eye-catching styles for every home.

it —

Moderno e contemporaneo. Audace e sincero. Materico e affascinante. Cosa ispira te e le tue pareti? Crea un effetto wow immediato con il nostro rivestimento murale 3D. Dai grandi pannelli 3D alle forme classiche, abbiamo una gamma di stili accattivanti per ogni casa.

pt —

Moderno e contemporâneo. Arrojado e extemporâneo. Texturado e fascinante. O que o(a) inspira a si e às suas paredes? Crie um efeito deslumbrante imediato com os nossos revestimentos de parede 3D. Desde grandes painéis 3D até às formas clássicas, temos uma gama de estilos atrativos para cada casa.

ro —

Modern și contemporan. Îndrăzneț și cu un mesaj clar. Texturat și fascinant. Care este inspirația dumneavoastră și a pereților dumneavoastră? Creați un efect „Wow” instantaneu, cu ajutorul lambrurilor 3D. De la panouri 3D de mari dimensiuni la forme clasice, avem o gamă de stiluri atractive pentru fiecare locuință.

cz —

Moderní a soudobé. Odvážné a výrazné. Texturované a fascinující. Co vás a vaše stěny inspiruje? Vytvořte oslňující efekt s naší 3D nástěnnou krytinou. Od velkých 3D panelů po klasické tvary – máme v nabídce širokou škálu atraktivních stylů pro každý domov.



W108 | W108F ZIGZAG

200 x 25 x 1,8 cm
Purotouch®
Designed by
Orio Tonini

NEW FLEX



W108 ZIGZAG + 2x CX190



W109 | W109F VALLEY

200 x 25 x 1,3 cm
Purotouch®
Designed by
Orio Tonini

NEW FLEX



W109 VALLEY + 2x CX190



W110 | W110F HILL

200 x 25 x 1,6 cm
Purotouch®
Designed by
Orio Tonini

NEW FLEX



W110 HILL + 2x CX190



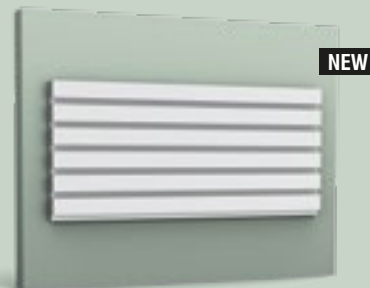

3 W111 BAR
200 x 25 x 2 cm
Purotouch[®]
Designed by
Orio Tonini

W111 + 2x CX190



2 W130 CHEVRON
200 x 40 x 2 cm
Purotouch[®]

W130 + 2x CX190

120



1. CX190 p.150



4. SX194 p.113

121



4 W112 RIDGE
200 x 25 x 1,9 cm
Purotouch[®]
Designed by
Orio Tonini



W112 + 2x CX190



2 W113 COBBLE
200 x 25 x 2,18 cm
Purotouch[®]
Designed by
Orio Tonini



W113 + 2x CX190

122



1. SX155 p.96



3. SX171 p.101

123

Positive Thermal & Acoustic Effects

EFFETTI TERMICI E ACUSTICI POSITIVI
EFEITOS TÉRMICOS E ACÚSTICOS POSITIVOS
EFECTE TERMICE ȘI ACUSTICE POZITIVE
POZITIVNÍ TEPELNÉ A AKUSTICKÉ EFEKTY



THERMAL INSULATION

Isolamento termico | Isolamento térmico
Izolație termică | Tepelná izolace

$\lambda = 0,029 \text{ W/mK} - R = 0,55 \text{ m}^2\text{K/W}$

Equals effect of insulation board
of the same thickness.

Ugualo effetto del pannello isolante dello stesso spessore.

Efeito igual ao da placa de isolamento da mesma espessura.

Efect egal al plăcii izolante de aceeași grosime.

Stejný efekt jako izolační deska stejné tloušťky.



ACOUSTIC ABSORPTION

Assorbimento acustico | Absorção acústica
Absorbție acustică | Akustická absorpce

CLASS E

Absorbs up to 25% of a conversation.

Assorbe fino al 25% di una conversazione.

Absorve até 25% de uma conversa.

Absoarbe până la 25% dintr-o conversație.

Absorbuje až 25% konverzace.



Flex Panels

Our wall panels ZIGZAG, VALLEY and HILL are now also available in a flexible version.

I nostri pannelli da parete ZIGZAG, VALLEY e HILL sono ora disponibili anche in una versione flessibile.

Os nossos painéis de parede ZIGZAG, VALLEY e HILL agora também estão disponíveis numa versão flexível.

Panourile noastre de perete ZIGZAG, VALLEY și HILL sunt acum disponibile și într-o versiune flexibilă.

Naše stěnové panely ZIGZAG, VALLEY a HILL jsou nyní k dispozici také ve flexibilní verzi.

1 W108 | W108F ZIGZAG

200 x 25 x 1,8 cm
Purotouch®
Designed by
Orio Tonini



2 W109 | W109F VALLEY

200 x 25 x 1,3 cm
Purotouch®
Designed by
Orio Tonini



3 W110 | W110F HILL

200 x 25 x 1,6 cm
Purotouch®
Designed by
Orio Tonini

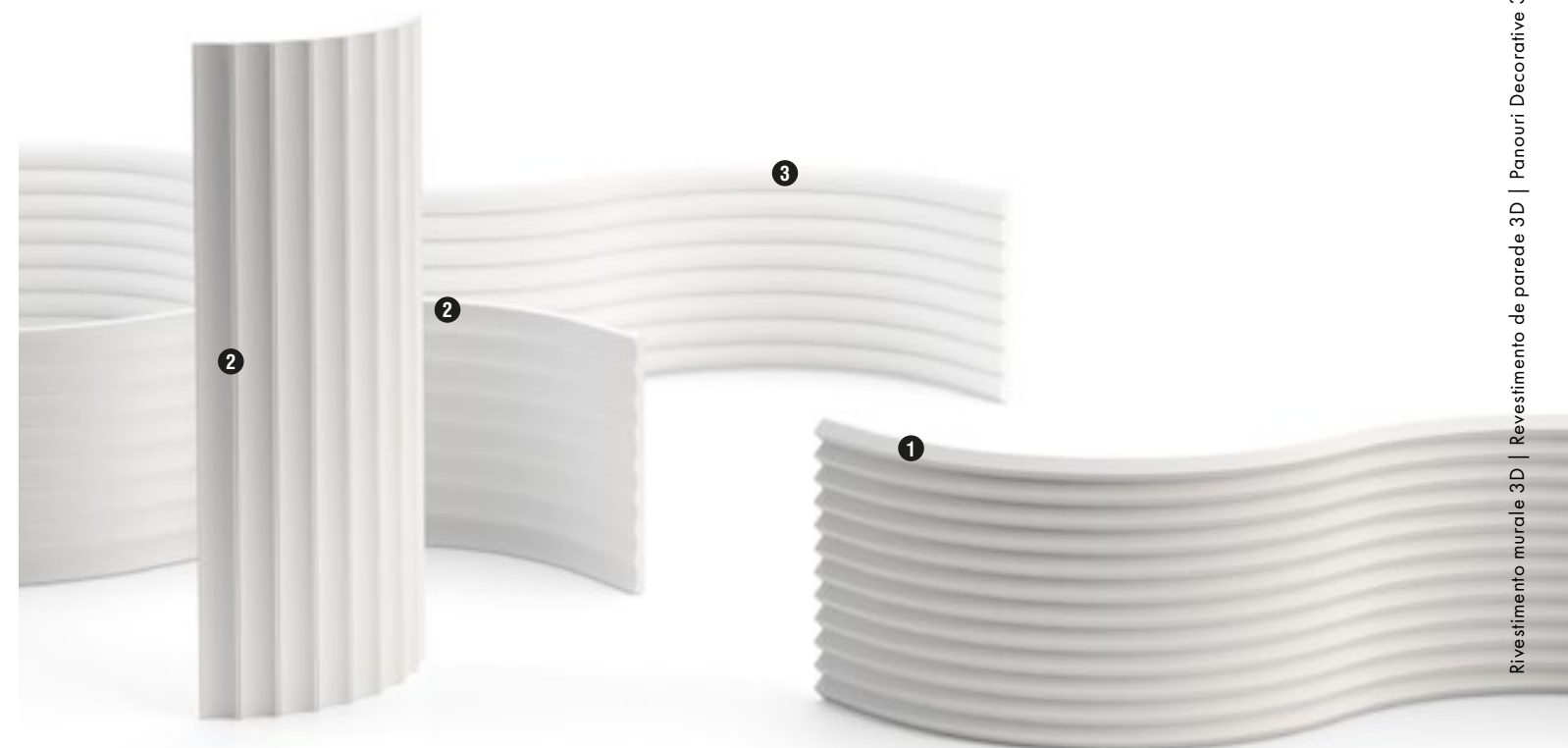

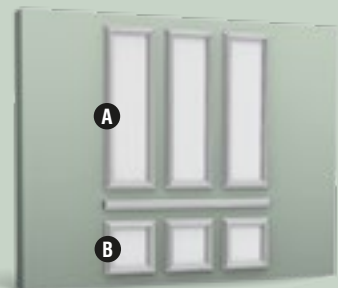

W120 + P4025 + W121
Purotouch®
Designed by
Orio Tonini



6 W120 AUTOIRE A
50 x 150 x 3,2 cm
Purotouch®
Designed by
Orio Tonini

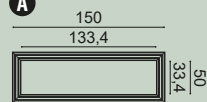

2 W121 AUTOIRE B
50 x 50 x 3,2 cm
Purotouch®
Designed by
Orio Tonini

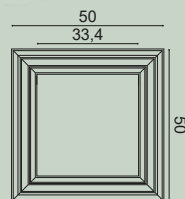

4 W122 AUTOIRE C
33,3 x 33,3 x 2,6 cm
Purotouch®
Designed by
Orio Tonini

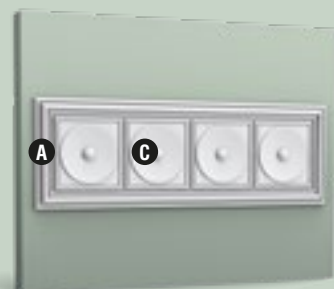
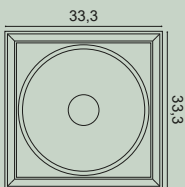

W120 + 4*W122
Purotouch®
Designed by
Orio Tonini

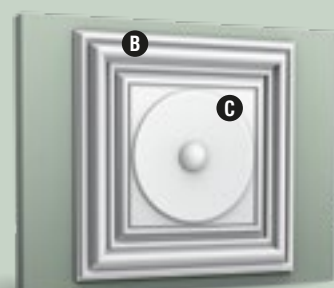

W121 + W122
Purotouch®
Designed by
Orio Tonini



5 W123 AUTOIRE D
33,3 x 33,3 x 3,5 cm
Purotouch®
Designed by
Orio Tonini

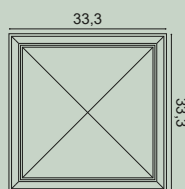

W120 + 4*W123
Purotouch®
Designed by
Orio Tonini

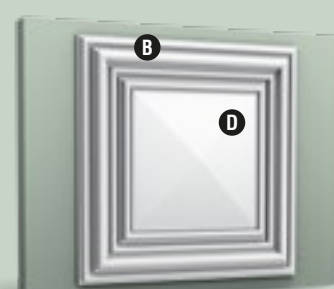

W121 + W123
Purotouch®
Designed by
Orio Tonini





W100 ROMBUS
25,8 x 15 x 2,9 cm
Purotouch®

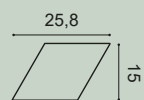

W101 TRAPEZIUM
34,5 x 15 x 2,9 cm
Purotouch®

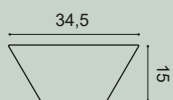

W105 ROMBUS
30 x 34,6 x 3 cm
Purotouch®

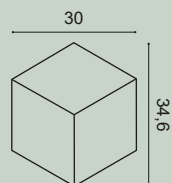

W102 CUBI
33,3 x 33,3 x 2,5 cm
Purotouch®

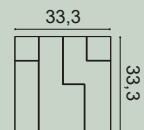

W103 CUBI
33,3 x 33,3 x 2,5 cm
Purotouch®

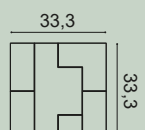

1 W106 ENVELOP

33,3 x 33,3 x 2,9 cm
Purotouch®
Designed by
Orio Tonini

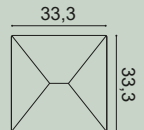

2 W107 CIRCLE

33,3 x 33,3 x 2,9 cm
Purotouch®
Designed by
Orio Tonini

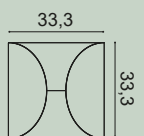

3 F30

59,5 x 59,5 x 4,3 cm
Purotouch®



Indirect Lighting

ILLUMINAZIONE INDIRETTA / ILUMINAÇÃO INDIRETA
ILUMINATUL INDIRECT / NEPŘÍMÉ OSVĚTLENÍ

130

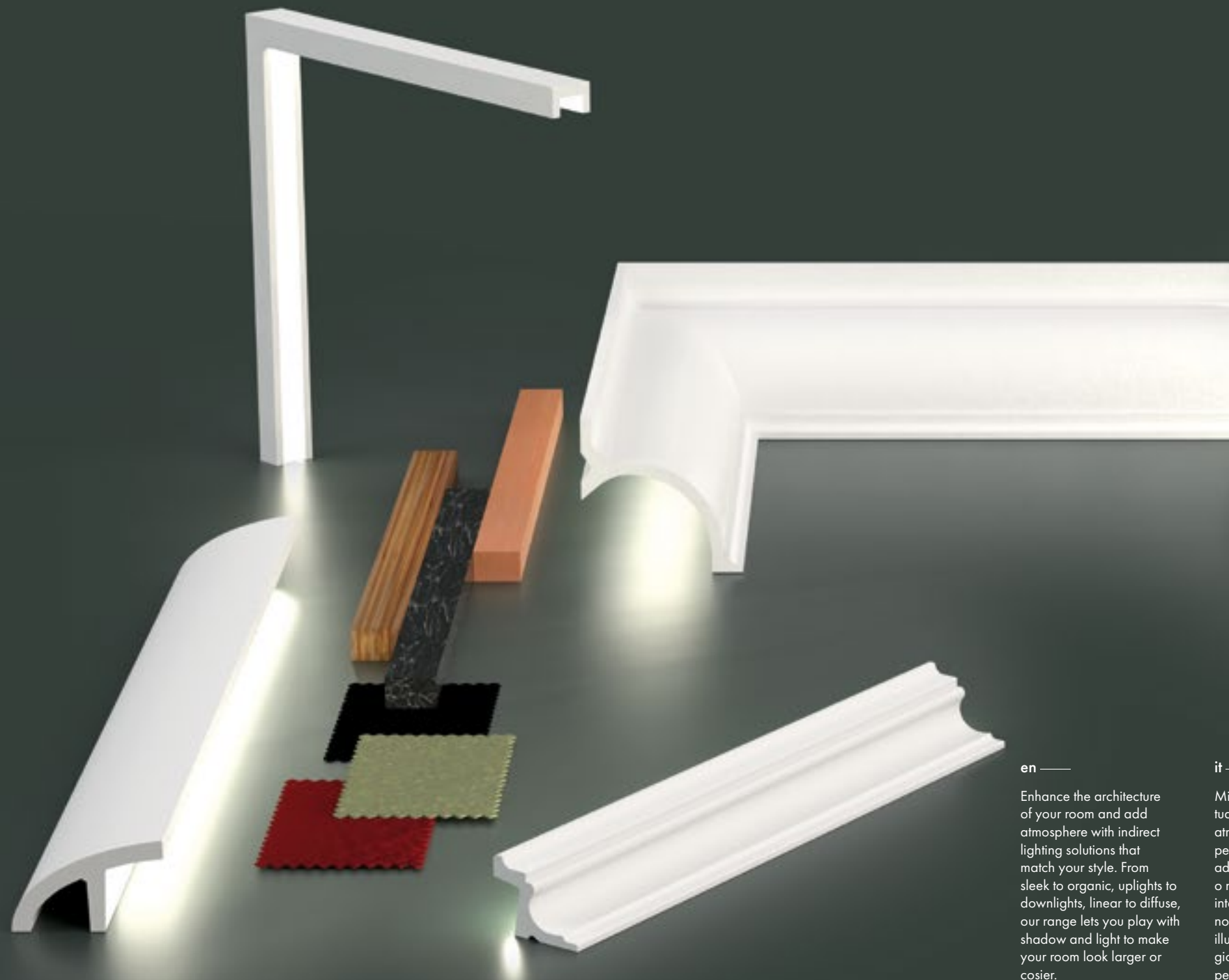

en

Enhance the architecture of your room and add atmosphere with indirect lighting solutions that match your style. From sleek to organic, uplights to downlights, linear to diffuse, our range lets you play with shadow and light to make your room look larger or cosier.

it

Migliora l'architettura della tua stanza e donale più atmosfera con le cornici per l'illuminazione indiretta adatte al tuo stile. Eleganti o naturali, ad alta o bassa intensità, lineari o diffuse, la nostra gamma di soluzioni di illuminazione ti permette di giocare con l'ombra e la luce per rendere la tua stanza più ampia o accogliente.

pt

Melhore a arquitetura da sua sala e crie uma atmosfera com soluções de iluminação indireta que combinam com o seu estilo. De elegante a orgânica, passando das luzes baixas à difusão, a nossa gama permite-lhe jogar com a sombra e a luz para tornar a sua sala maior ou mais confortável.

ro

Perfecționați arhitectura încăperii și generați atmosferă cu soluțiile de iluminare indirectă care se potrivesc stilului dumneavoastră. De la subțire la organic, prin corpurile de iluminat ascendent sau descendent, liniar sau difuz, gama noastră vă permite să vă jucați cu umbrele și luminile, pentru a genera un aspect mai spațios sau mai primitiv al încăperii.

cz

Pozvedněte architekturu místnosti a dodejte prostoru atmosféru pomocí řešení s nepřímým osvětlením dle svého vkusu. Od jednoduchého po organické osvětlení, směřující vzhůru nebo dolů, lineární nebo rozptýlené světlo – v naší nabídce si můžete hrát se světlem a stíny, a dodávat tak prostoru na optické velikosti nebo útulnosti.

131



C323
200 x 5,5 x 4,2 cm
Purotouch®

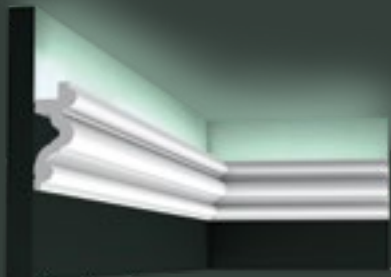

6 C324 AUTOIRE
200 x 8,3 x 3,4 cm
Purotouch®
Designed by
Orio Tonini

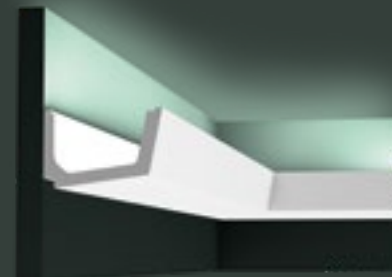

C357 STRAIGHT
200 x 7,1 x 11 cm
Purotouch®
Designed by
Jacques Vergracht

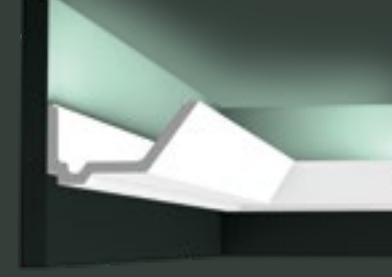
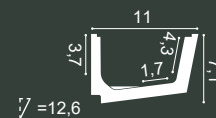

C358 RAIL
200 x 7,3 x 14 cm
Purotouch®
Designed by
Jacques Vergracht

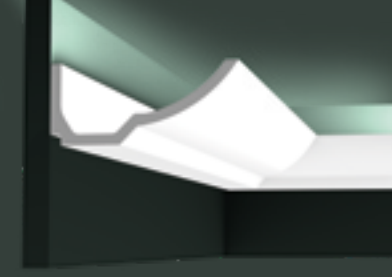
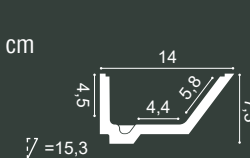

C351 BOAT
200 x 7,4 x 17,3 cm
Purotouch®
Designed by
Jacques Vergracht

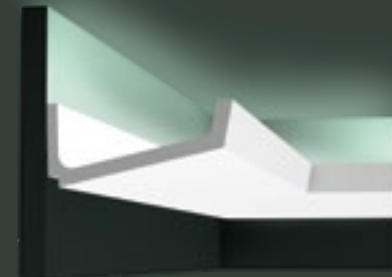
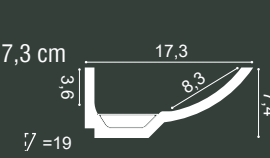

C352 FLAT
200 x 7,6 x 17,1 cm
Purotouch®
Designed by
Jacques Vergracht

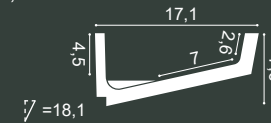

C902 | C902F
200 x 10,3 x 10,3 cm
Purotouch®

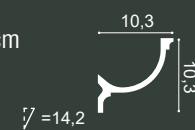

C901 | C901F
200 x 14,8 x 12,4 cm
Purotouch®

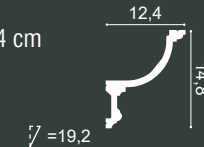

C900
200 x 17,1 x 14,6 cm
Purotouch®

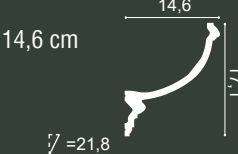

L3 Lighting Combinations

C380

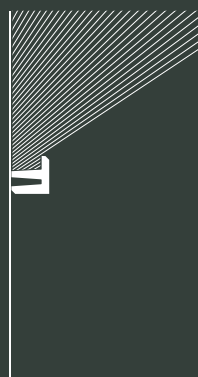

C382 + C380

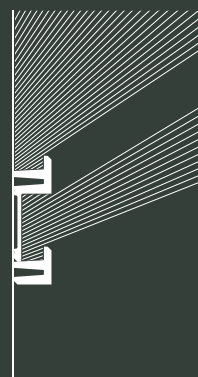

2 C382 + C382 + C380

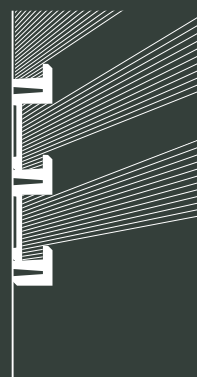

C382 + C382 + C381

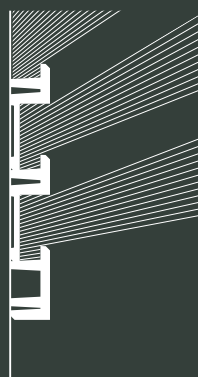

C381

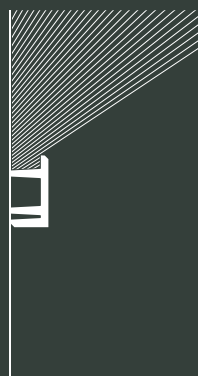

C383 + C381

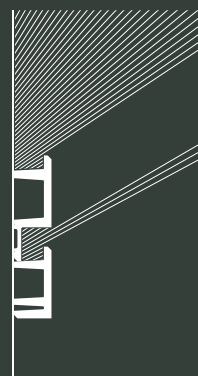

C383 + C383 + C381

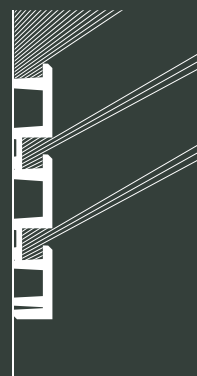

C383 + C382 + C381

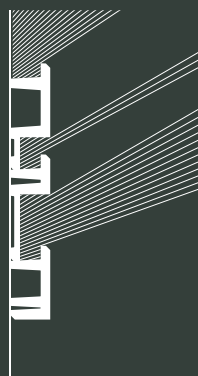

C382 + C383

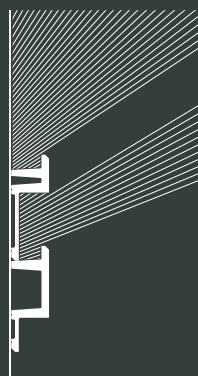

C381 + C382



C382 + C382

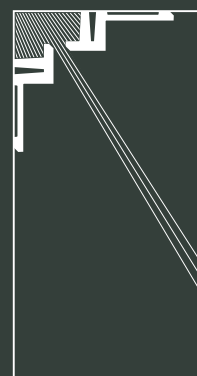

4 C382 + C382 + C382

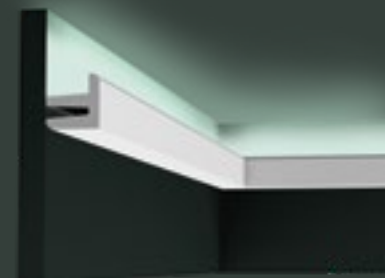
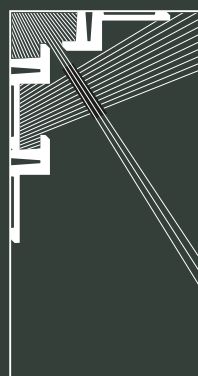

C380 L3 Linear Led Lighting

200 x 5 x 5 cm
Purotouch®
Designed by
Orio Tonini

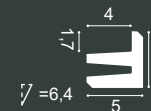

C381 L3 Linear Led Lighting

200 x 9,5 x 5 cm
Purotouch®
Designed by
Orio Tonini

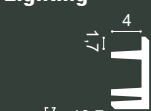

C382 L3 Linear Led Lighting

200 x 14 x 5 cm
Purotouch®
Designed by
Orio Tonini



3 C383 L3 Linear Led Lighting

200 x 14 x 5 cm
Purotouch®
Designed by
Orio Tonini



Steps

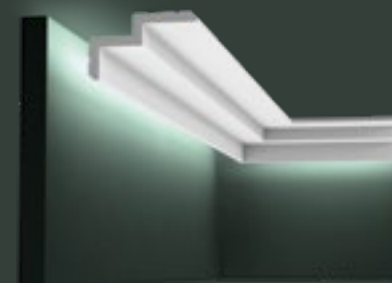

1 C390 STEPS
200 x 6 x 10 cm
Purotouch®
Designed by
Orio Tonini

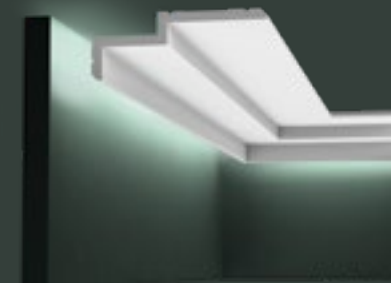
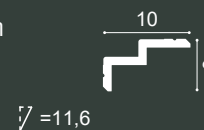

C391 STEPS
200 x 6 x 16 cm
Purotouch®
Designed by
Orio Tonini

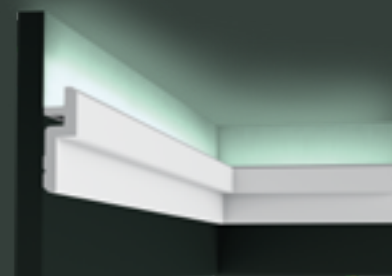
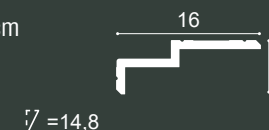

C394 STEPS
200 x 9,5 x 3,1 cm
Purotouch®
Designed by
Orio Tonini

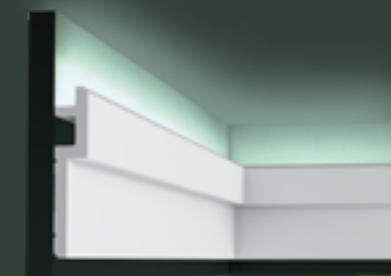
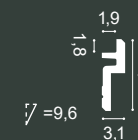

C395 STEPS
200 x 15,5 x 3,1 cm
Purotouch®
Designed by
Orio Tonini

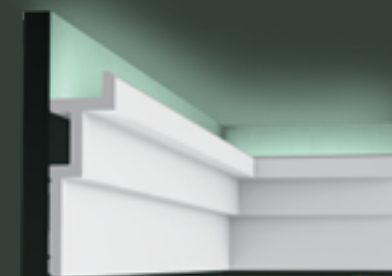
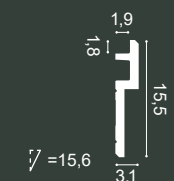

C396 STEPS
200 x 18,5 x 6,1 cm
Purotouch®
Designed by
Orio Tonini

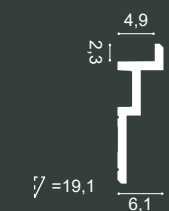

INDIRECT LIGHTING | СКРЫТОЕ ОСВЕЩЕНИЕ | LISTWY OŚWIETLENIOWE | إضاءة غير مباشرة | ÉCLAIRAGE INDIRECT

C390



C391



C394

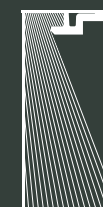

C395

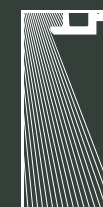

C394



C395



C396



DOWNLIGHTER

UPLIGHTER

Compact Design Lighting

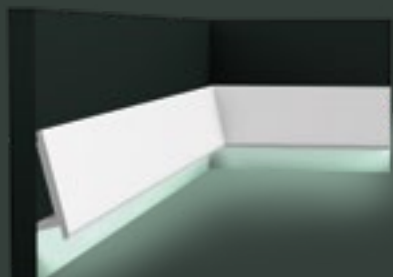

SX179 DIAGONAL
200 x 9,7 x 2,9 cm
Duropolymer®
Designed by
Orio Tonini

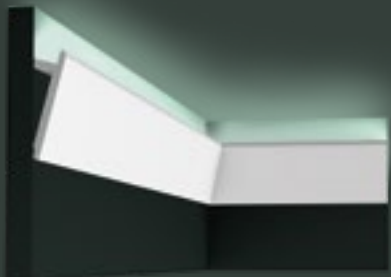
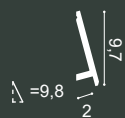

SX179 DIAGONAL
200 x 9,7 x 2,9 cm
Duropolymer®
Designed by
Orio Tonini

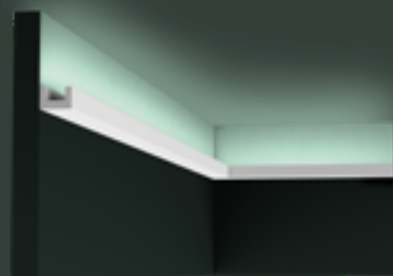
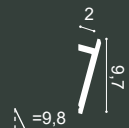

CX190 | CX190F U-PROFILE
200 x 2 x 3 cm
Duropolymer®
Designed by
Orio Tonini

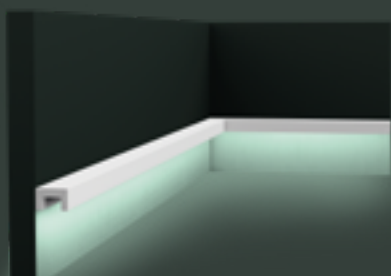

CX190 | CX190F U-PROFILE
200 x 2 x 3 cm
Duropolymer®
Designed by
Orio Tonini



CX190 | CX190F U-PROFILE
200 x 2 x 3 cm
Duropolymer®
Designed by
Orio Tonini

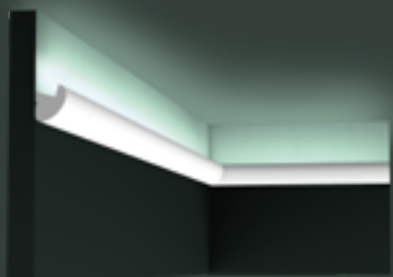

CX188 | CX188F
200 x 3,4 x 3 cm
Duropolymer®
Designed by
Orio Tonini

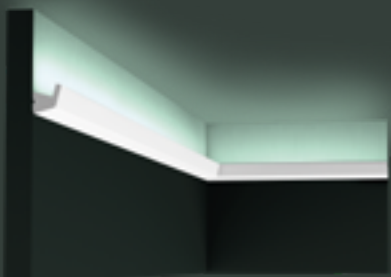

CX189 | CX189F
200 x 2,7 x 2,7 cm
Duropolymer®
Designed by
Orio Tonini



1. SX180 p.102

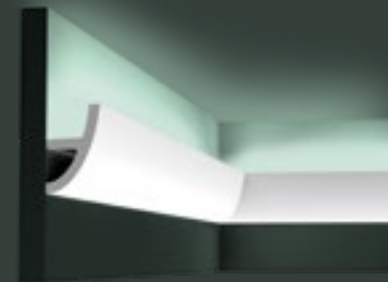
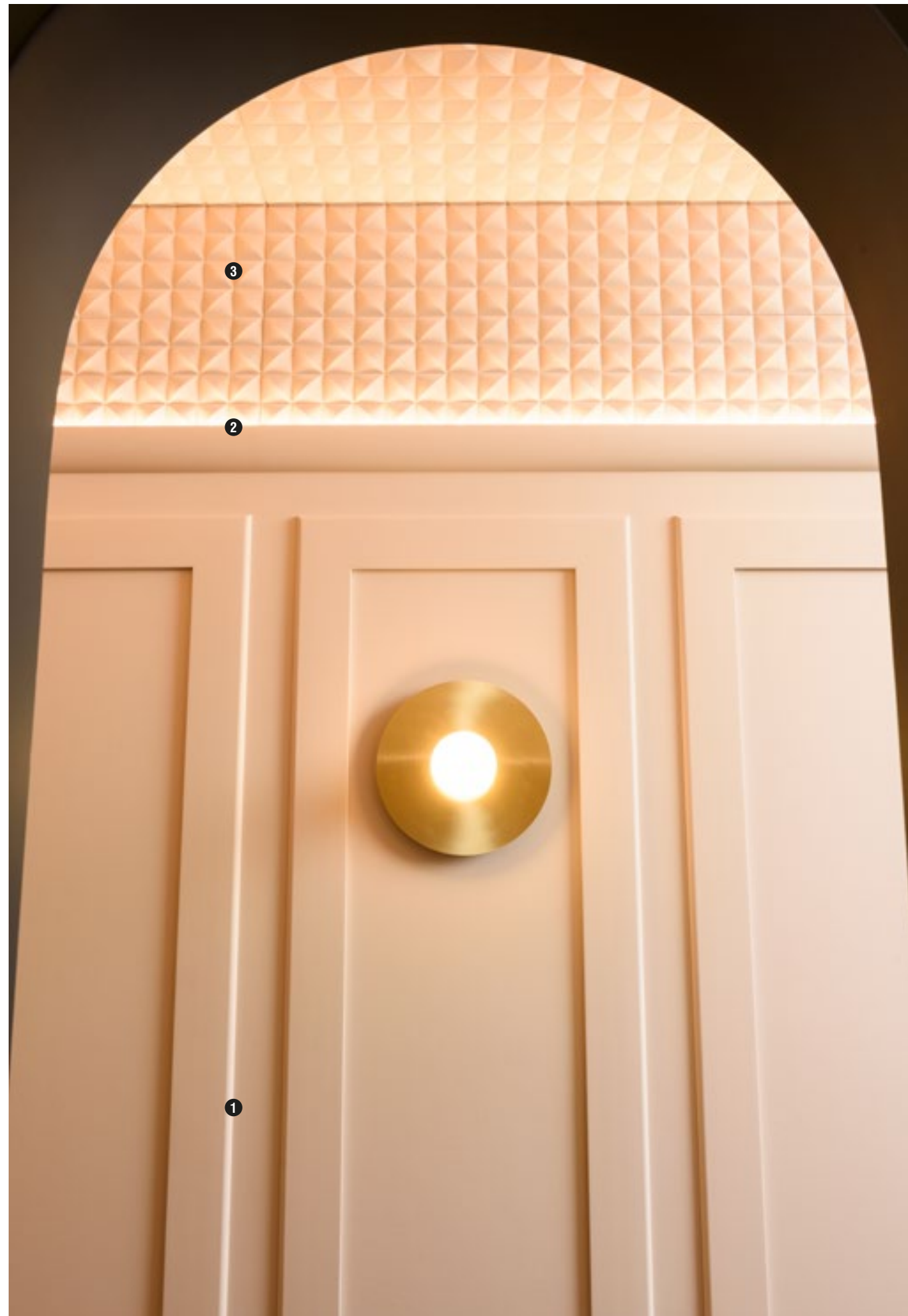

2 C373 | C373F ANTONIO
200 x 8 x 5 cm
Purotouch®
Designed by
Ulf Moritz

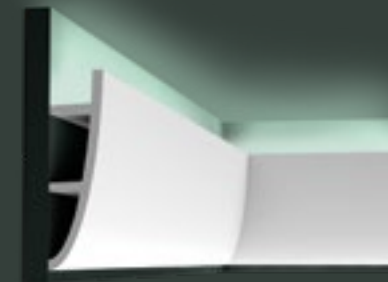
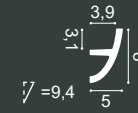

C374 ANTONIO
200 x 18 x 5 cm
Purotouch®
Designed by
Ulf Moritz

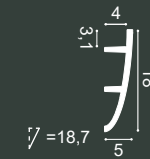

ULF MORITZ
FOR
ORAC
DECOR

C373 + C374

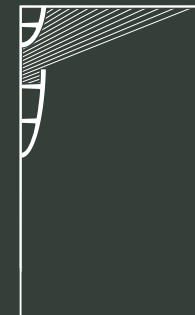

C373 + C373

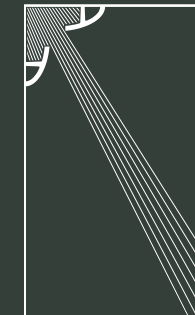

C374 + C991

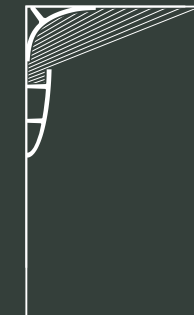

C373 + C373

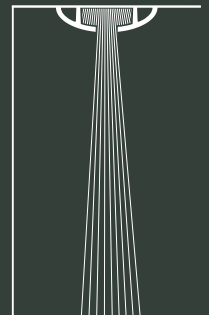

C374 + C374

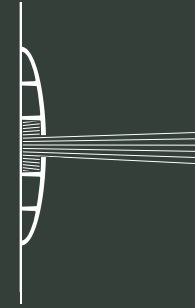

C373 + C374

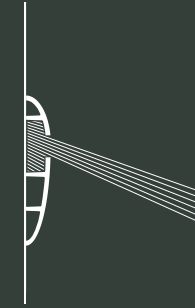

C373 + C373

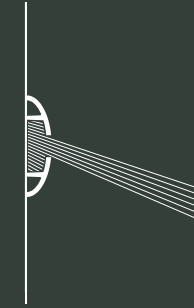

C374 + C373



C373 + C374

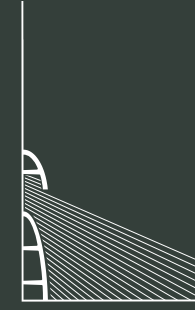

C374 + C374

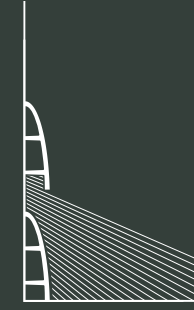

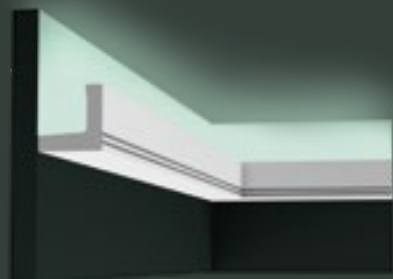

C361 STRIPE

200 x 5 x 5 cm
Purotouch®
Designed by
Pierre Daems

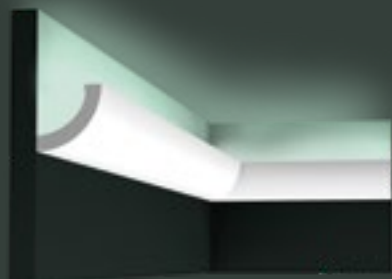
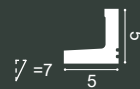

C362 CURVE

200 x 5 x 5 cm
Purotouch®
Designed by
Pierre Daems

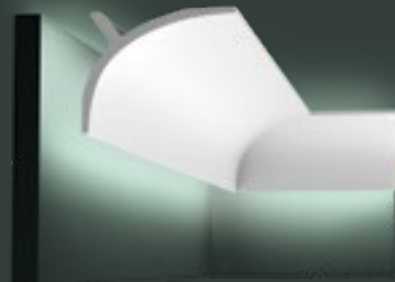
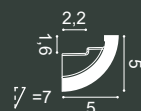

3 C991

200 x 11 x 14 cm
Purotouch®

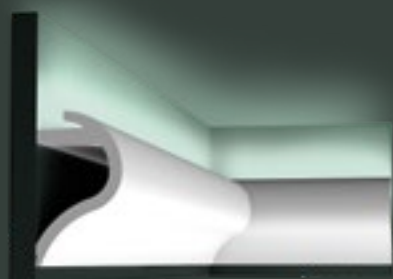
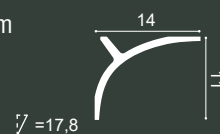

C364 WAVE

200 x 14 x 8 cm
Purotouch®
Designed by
Pierre Daems

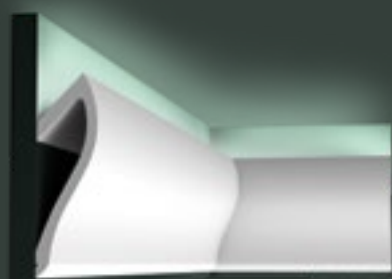
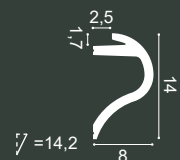

C371 SHADE

200 x 18,5 x 5,8 cm
Purotouch®
Designed by
Ulif Moritz

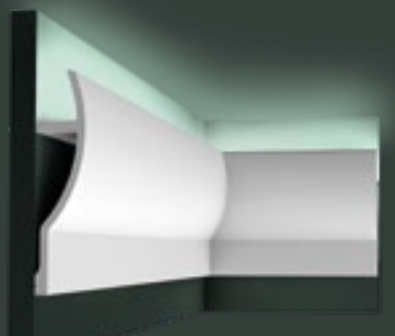
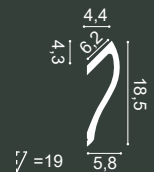

C372 FLUXUS

200 x 28 x 7 cm
Purotouch®
Designed by
Ulif Moritz

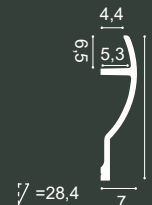

1. SX191 p.95 | 2. P4025 p.106 | 4. F30 p.129

Deco Elements

ELEMENTI DECORATIVI / ELEMENTOS DECORATIVOS
ELEMENTE DECORATIVE / DEKORATIVNÍ PRVKY



en —

Add a sophisticated final touch to your walls with our deco elements. Ranging from door frames, columns and pilasters to ceiling roses, these elements give your walls elegance, beauty and style that match your vision and budget.

it —

Aggiungi un tocco finale sofisticato alle tue pareti con i nostri elementi decorativi. Dalle cornici delle porte, dalle colonne e dai pilastri ai rosoni sul soffitto, usa questi elementi per conferire alle pareti eleganza, bellezza e stile in base alla tua visione e al tuo budget.

pt —

Dê um toque final sofisticado às suas paredes com os nossos elementos decorativos. Desde molduras de portas, colunas e pilares até rosetas para o teto, estes elementos conferem elegância, beleza e estilo às suas paredes, que combinam com a sua visão e orçamento.

ro —

Aplicați o tușă finală sofisticată pereților dumneavoastră, cu ajutorul elementelor noastre decorative. De la cadre pentru uși până la coloane și stâlpi și chiar până la trandafiri pentru plafon, aceste elemente conferă pereților eleganță, frumusețe și stil, conform viziunii și bugetului dumneavoastră.

cz —

Dodejte stěnám nádech rafinovanosti s našimi dekoračními prvky. Od rámu dveří, sloupů a pilířů po stropní rozety – tyto prvky propůjčí stěnám eleganci, krásu a styl podle vaší vize a rozpočtu.

CEILING ROSES / ROSONI / ROSETAS / ROZETE / ROZETY



R13 ⊕
ø 28 x 3,1 - ø 2,5 cm
Purotouch[®]



R14 ⊕
ø 33 x 3 - ø 2,5 cm
Purotouch[®]



R31 ⊕
ø 38,5 x 2,7 - ø 3,5 cm
Purotouch[®]



R17 ⊕
ø 47 x 3,5 - ø 6,5 cm
Purotouch[®]



R18
ø 49 x 4,7 - ø 7 cm
Purotouch[®]



R52 ⊕
ø 69,5 x 4,8 - ø 12,5 cm
Purotouch[®]



R73 ⊕
ø 70 x 5,9 - ø 8 cm
Purotouch[®]



R23
ø 71 x 4,4 - ø 6 cm
Purotouch[®]



R52 ⊕
ø 75 x 4,5 - ø 9 cm
Purotouch[®]



R10 ⊕
ø 15 x 4,2 - ø 2 cm
Purotouch[®]



R11
ø 19 x 3,6 - ø 3 cm
Purotouch[®]



R12
ø 19,5 x 1,8 - ø 1 cm
Purotouch[®]



R22
77,5 x 53 x 3,6 cm
Purotouch[®]



R24
ø 79 x 6 - ø 8 cm
Purotouch[®]



R64 ⊕
ø 95,2 x 4,8 - ø 7 cm
Purotouch[®]



R07
ø 26 x 3 - ø 5 cm
Purotouch[®]

1 R08
ø 38 x 4,2 - ø 5 cm
Purotouch[®]

R09 ⊕
ø 48,5 x 3,7 - ø 6 cm
Purotouch[®]



R66
ø 54,5 / 43 x 2,4 cm
Purotouch[®]

R76
ø 62 x 4,1 - ø 10,5 cm
Purotouch[®]

R77
ø 62 x 4,2 - ø 10,5 cm
Purotouch[®]



R40 ⊕
ø 74,5 x 3,1 - ø 10 cm
Purotouch[®]

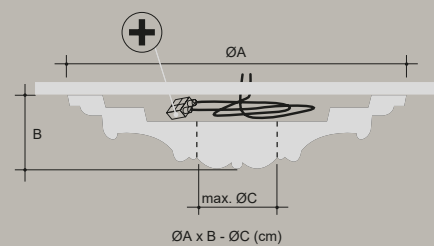

⊕ ROOM FOR CABLES
Spazio per i cavi
Espaço para cabos
Spatiu pentru cabluri
Prostor pro kably



DOOR FRAMES / CONTORNI PORTA / MOLDURAS DE PORTA
ANCADRAMENTE DE USI / DVEŘNÍ RÁMY

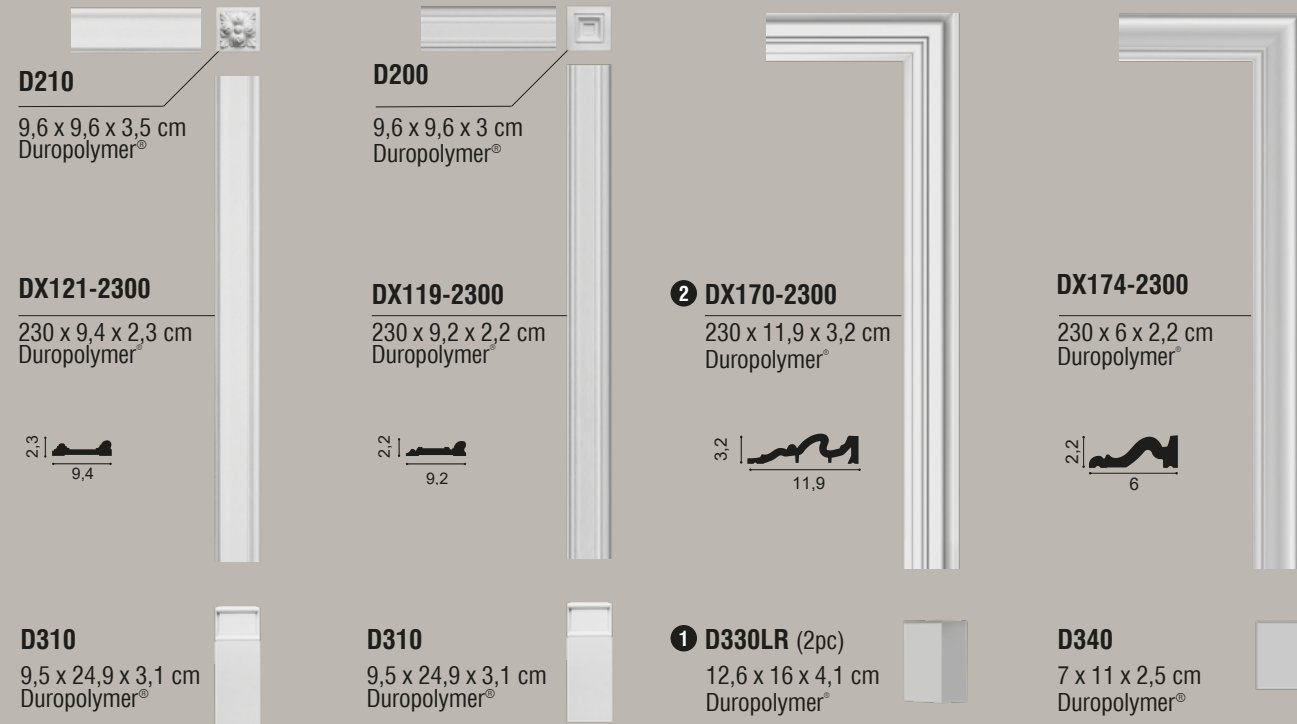

PEDIMENTS / FRONTONI / FRONTÕES / FRONTOANE / ŘÍMSY

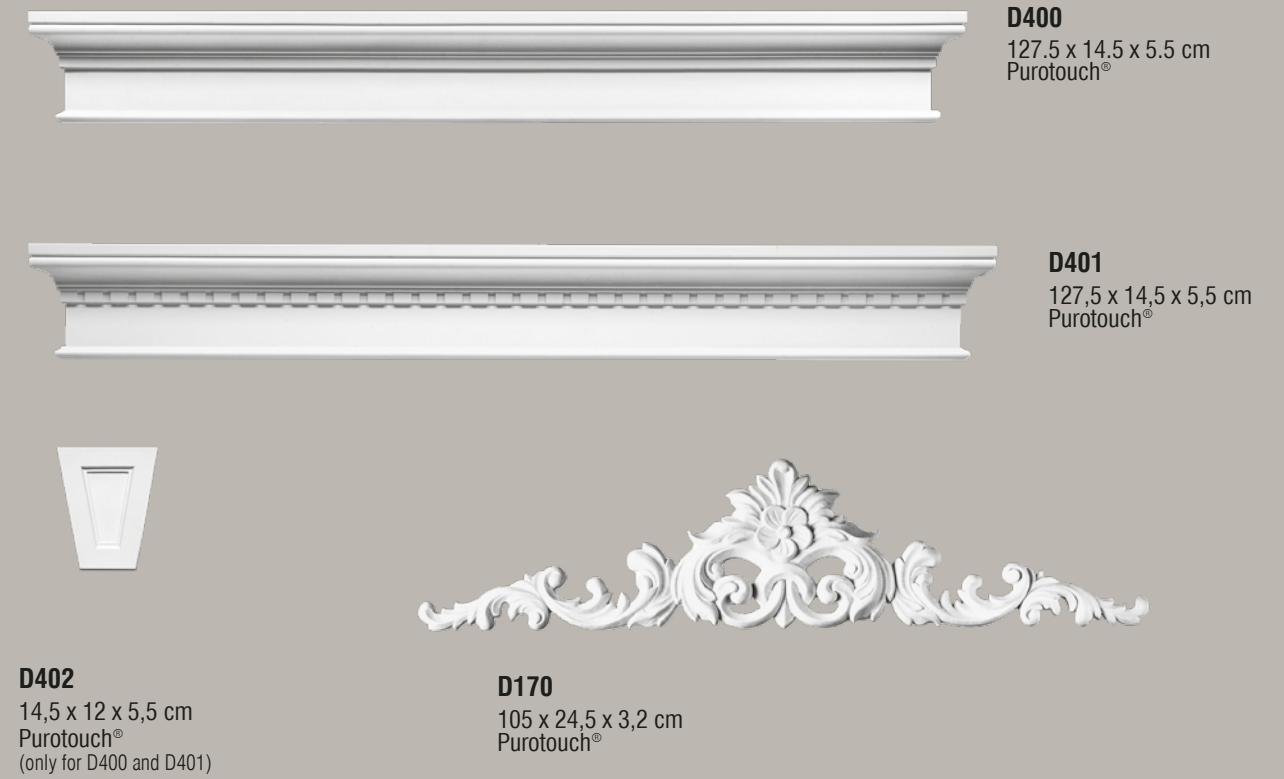

150



DOOR PANNELLING / PANNELLI PER PORTA / PAINÉIS PARA PORTAS
PANOURI PENTRU USI / OBLOŽENÍ DVEŘÍ



151

FULL COLUMNS / COLONNE INTERE
COLUNAS COMPLETAS / COLOANE INTREGI
PLNÉ SLOUPY

HALF COLUMNS / MEZZE COLONNE
MEIAS COLUNAS / COLOANE JUMATATI
POLOVIČNÍ SLOUPY

PILASTERS / PILASTRI / PILASTRAS / PILASTRI / PILASTRY

K1112
(H 30cm)
Duropolymer[®]

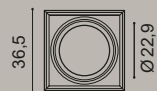

K1122
(H 30cm)
Duropolymer[®]



K1002
(H 199,5cm)
Purotouch[®]

Ø 22



K1102
(H 202cm)
Purotouch[®]

Ø 22



K1111
(H 30cm)
Duropolymer[®]

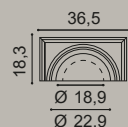

K1121
(H 30cm)
Duropolymer[®]

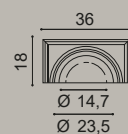

K1001
(H 199,5cm)
Purotouch[®]

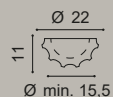

K1101
(H 202cm)
Purotouch[®]

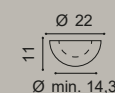

K1152 (H 12,5 cm)
Duropolymer[®]



K1151 (H 12,5 cm)
Duropolymer[®]

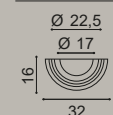

K1132 (H 57,5 cm)
Purotouch[®]



K1131 (H 57,5 cm)
Purotouch[®]

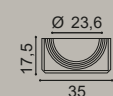

K251 (H 35 cm)
Purotouch[®]

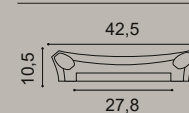

K250 (H 200 cm)
Purotouch[®]

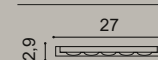

K201 (H 14,9 cm)
Purotouch[®]

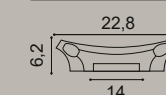

K200 (H 200 cm)
Purotouch[®]

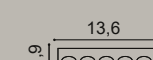

K254 (H 53,5 cm)
Purotouch[®]

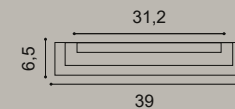

K202 (H 54,1 cm)
Purotouch[®]

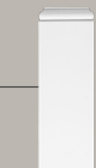
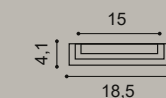

D320 (H 24,8 cm)
Purotouch[®]

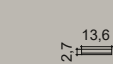

K1112 + K1002 + K1152 = 242 cm H
K1112 + K1002 + K1132 = 287 cm H max
K1122 + K1102 + K1152 = 242 cm H
K1122 + K1102 + K1132 = 287 cm H max

K1111 + K1001 + K1151 = 242 cm H
K1111 + K1001 + K1131 = 287 cm H max
K1121 + K1101 + K1151 = 242 cm H
K1121 + K1101 + K1131 = 287 cm H max



The Perfect Finish

La finitura perfetta / O acabamento perfeito
Finisare perfecta / Perfektní zakončení

Ready? Set? Go!



INSTALLATION
WARRANTY

ONLY FULL GUARANTEE WITH DECOFIX
GARANZIA COMPLETA SOLO CON COLLANTE DECOFIX
GARANTIA COMPLETA APENAS COM DECOFIX
GARANTIE COMPLETA DOAR FOLOSIND DECOFIX
PLNÁ ZÁRUKA POUZE S LEPIDLEM DECOFIX

Ready?

SURFACE & ATMOSPHERE

Ambiente & Superficie | Ambiente & Superficie | Suprafata & Ambient | Povrch & podmínky



Storage and installation conditions: Store profiles and adhesives at room temperature and wait 24 hours before installing.

Condições de instalação e armazenamento: Ter os perfis e o colante a temperatura ambiente pelo menos 24 horas antes da aplicação.
Condições de armazenamento e instalação: guardar os perfis e as colas no local 24 horas antes da aplicação.
Condiții de depozitare și instalare: depozitați profilele și adezivii la temperatura camerei cu 24h înainte de instalare.
Skladovací a instalační podmínky: skladujte profily a lepidla v pokojové teplotě a vyčkejte 24 hod než začnete instalovat.

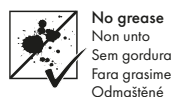
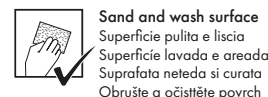

Set?

DECOFIX ADHESIVES

Collanti Decofix | Colas DecoFix | Adezivi Decofix | Decofix lepidla

Interior, porous and dry surface

Per interni, superfici porose, ambienti asciutti
| Interior, superficies porosas e secas
| Suprafata la interior, poroasa și uscată | Pro
použití v interiéru, porézni a suchý povrch



Exterior, non-porous and humid surface

Per esterno, superfici non porose, ambienti umidi
| Exterior, superficies não porosas e ambientes
húmidos | Suprafata la exterior, non-poroasa și
umedă | Pro použití v exteriéru, neporézni a vlhký
povrch



Seal wall / ceiling
Incollaggio su muri e soffitti
Colar a tetos/paredes
Inchidere perete / tavan
Stěna & strop



DecoFix Pro

Strong, water-based acrylic installation adhesive

FDP500 310ml | 7 > 8m
FDP600 4200ml | 65 > 110m



or
of
ou
oder
o



DecoFix Power

Very strong MS-Polymer-based installation adhesive

FDP700 290ml | 7 > 8m



Joints between moldings*
Unione delle giunte dei profili
Uniãoes dos perfis
Imbinarile dintre profile
Spoje mezi listami



DecoFix Extra

Polyurethane-based adhesive

FX200 310ml | min. 80m
FX210 tube 80ml | min. 20m



* For Durofoam®: use DecoFix Pro for joints

Per Durofoam®: usare Decofix Pro per le giunte | Para Durofoam®: use
DecoFix Pro para as uniões das peças | Pentru Durofoam®: foloseste DecoFix
Pro la imbinari | Durofoam®: používejte DecoFix pro spoje

Go!



INSTALLATION VIDEOS & MANUALS
DECOFIX GLUE CALCULATOR

SCAN THE QR CODE OR
VISIT WWW.ORACDECOR.COM > INSTALLATION

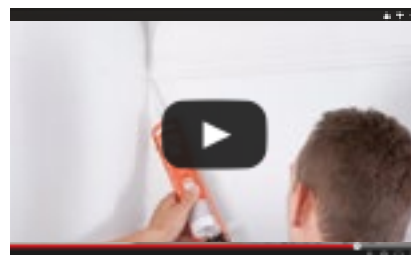

DecoFix Pro

FDP500 310ml
> 7 - 8m
FDP600 4200ml
> 65 - 110m



en Extra strong installation adhesive for porous surfaces and interior applications
· Strong, water-based acrylic glue
· Long-lasting seal between moldings and the wall and/or ceiling
· Remove with humid sponge or cloth
· Should be kept frost free
· Paintable after hardening (min. 24 hours)

it Colla acrilica ultra forte per superfici porose e per l'applicazione all'interno
· Colla acrilica a base d'acqua, forte
· Incollaggio a lunga durata tra le cornici ed il muro e/o il soffitto
· Rimuovere l'eccesso con una spugna o uno straccio umidi
· Tenere il prodotto al riparo dal gelo
· Può essere verniciato dopo completa asciugatura (min. 24 ore)

pt Cola Extra Forte para superficies porosas e aplicações interiores
· Cola acrílica de base aquosa
· Selagem de longa duração entre sanças e parede e/ou teto
· Fácil remoção dos resíduos da cola com uma esponja ou pano húmido
· Deve ser guardado em ambiente seco
· Pintável após endurecimento (min. 24 horas)

ro Adeziv pentru o instalare foarte puternica pe suprafete poroase si aplicatii la interior
· Puternic, silicon acrilic pe baza de apa
· Lipire de lunga durata intre profile si perete si/sau tavan
· Se indeparteaza cu un burete umed sau o carpa. A se feri de inghet
· Vopsirea se face dupa intarire (min. 24h)

CZ Mimořádně silné montážní lepidlo pro porézni povrchy a pro použití v interiéru
· Silné akrylátové lepidlo na vodní bázi
· Dlouhodobé spojení mezi listou a stěnou nebo stropem
· Odstranění pomocí navlhčené houbičky nebo hadříku
· Chráněte před mrazem
· Po zatvrdnutí přetřítelné (min. za 24 hodin)

DecoFix Power

FDP700 290ml
> 7 - 8m



en Extra strong MS polymer glue for new build, all exterior applications, non-porous (tiles, glass, ...) surfaces and damp environments
· Remove with soap solution
· Paintable after hardening (min. 24 hours)

it Colla a base di polimeri MS extra forte per costruzione nuova, l'applicazione all'esterno, superfici non porose (piastrelle, vetro, ...) e ambienti umidi
· Rimuovere l'eccesso con una soluzione saponata
· Può essere verniciato dopo completa asciugatura (min. 24 ore)

pt Extra forte, cola a base de MS polímero, para nova construção, aplicações no exterior, superficies não porosas (Cerâmica, vidro, ...) e ambientes húmidos
· Removível com uma solução de água e sabão
· Pintável após endurecimento (min. 24 horas)

ro Silicon MS polimer foarte puternic pentru construcție nouă, instalarea la exterior, suprafețe non-poroase (gresie, sticlă, ...) și medii umede
· Se indeparteaza cu solutie de sapun
· Vopsirea se face dupa intarire (min. 24h)

CZ Mimořádně silné polymerové lepidlo pro nová výstavba, pro použití v exteriéru, pro neporezni povrchy (dlaždice, sklo...) a vlhke prostředí
· Odstranění mýdlovým roztokem
· Po zatvrdnutí přetřítelné (min. za 24 hodin)

DecoFix Extra

FX200 310ml
> 80m
FX210 80ml
> 20m



en Polyurethane-based glue to seam joints between moldings
· Remove excess glue before hardening (max. 1 hour and repeat after 2-3 hours)
· Clean with acetone or Synth Thinner
· Can be painted after 24 hrs
· The more humidity, the faster the drying time

it Saldante a base di poliuretano da utilizzare per saldare le giunte delle cornici
· Rimuovere l'eccesso di saldante prima dell'indurimento (massimo 1 ora e ripetere dopo 2-3 ore)
· Pulire con acetone o altro diluente sintetico
· Può essere verniciato dopo 24 ore
· Un tasso di umidità più alto può accelerare il tempo di asciugatura

pt Cola á base de poliuretano para união de juntas entre perfis
· Remove o excesso de cola antes de endurecer (máx. 1 hora e repita 2-3 horas depois)
· Limpe com acetona ou diluente sintético
· Pode ser pintado após 24 horas
· Quanto mais humidade mais rápido será o tempo de secagem

ro Silicon polyurethane pentru imbinarile dintre profile
· Se indeparteaza excesul de silicon inainte de intarire (max. 1h si se repeta dupa 2-3h)
· Se curata cu acetona sau diluant. Vopsirea se face dupa 24h.
· Cu cat mediul este mai umed, cu atat uscareea se face mai repede.

CZ Polyuretanové lepidlo pro pevné spojení mezi listami
· Po zatvrdnutí přebytečné lepidlo odstraňte (max. za 1 hodinu a znovu za 2-3 hodiny)
· Čistěte acetonem nebo syntetickým ředidlem
· Lze přetřít po 24 hodinách
· Vyšší vlhkost urychluje schnutí

ACCESSORIES | Accessori | Acessórios | Accesorii | Příslušenství



FB15

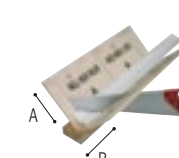

FB300
A: 29,7 cm
B: 29,1 cm

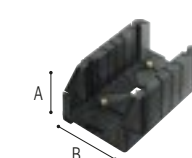

FB13
A: 12,5 cm
B: 15,5 cm

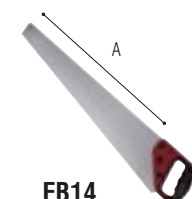

FB14
A: 60 cm



FB10
A: 27,5 cm - B: 22 cm

Flexible Products

Flex Radius	R min in cm	R* min in cm	R**min in cm	Flex Radius	R min in cm	R* min in cm	R**min in cm	Flex Radius	R min in cm	R* min in cm	R**min in cm
C211F	250			P3020F	50	180		SX187F	40		
C213F	280			P4020F	40	200		SX194F	40	80	
C215F	160			P4025F	70			SX195F	30		
C217F	380			P5021F	20	70		W108F		40	30
C220F	400			P7070F	30	230		W109F		40	30
C230F	150			P8020F	40	130		W110F		40	30
C240F	270			P8030F	20	70					
C250F	70			P8040F	30						
C304F	250			P8050F	80	200					
C321F	140			P9010F	40	310					
C325F	300			P9050F	20	60					
C326F	500			P9900F	20	250					
C331F	420			PX103F	20	80					
C333F	300			PX120F	30	110					
C334F	380			PX144F	20	220					
C339F	380			PX175F	30	80					
C341F	400			SX104F	40						
C373F	100			SX105F	30						
C901F	600			SX118F	40						
C902F	600			SX137F	40						
CX100F	200			SX138F	40						
CX106F	360			SX155F	30						
CX109F	160			SX157F	35	260					
CX110F	180			SX162F	20	80					
CX123F	280			SX163F	35						
CX124F	160			SX165F	40						
CX127F	240			SX172F	35						
CX132F	70			SX173F	45						
CX188F	110			SX180F	45						
CX189F	90			SX182F	35						
CX190F	30	130		SX183F	40						
DX174F	60	300		SX184F	45						

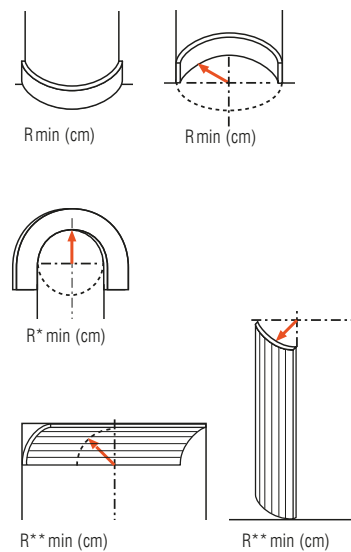

en —

A wide range of cornice mouldings, panel mouldings and skirting boards are available to give curved walls and ceilings an elegant finish. These elements are also light and can be painted.

The sky is the limit: add curved lines and circles to your walls and ceilings in no time.

it —

Una vasta gamma di cornici soffitto, cornici parete e battiscopa disponibili anche nella versione flessibile per decorare pareti e soffitti curvi in modo elegante. Anche questi elementi sono leggeri e possono essere verniciati.

Non avresti mai immaginato che sarebbe stato così facile decorare con linee curve e cerchi muro e soffitto.

pt —

Uma ampla gama de sancas, perfis e rodapés estão disponíveis para dar a tetos e paredes curvas um acabamento elegante. Estes elementos são também leves e pintáveis.

O céu é o limite: adicione linhas curvas e círculos às suas paredes e tetos com rapidez

ro —

O gamă largă de cornișe, brauri și plinte sunt disponibile pentru a oferi pereților și plafoanelor curbate o finisare elegantă. Aceste elemente sunt de asemenea ușoare și pot fi vopsite.

Cerul este limita: adăugați linii și cercuri curbate la pereții și plafoanele dvs. numaidecat.

cz —

Široká řada stropních, lemovacích a podlahových lišt je k dispozici k elegantnímu zakončení zaoblených stěn a stropů. Tyto prvky mohou být také přetírány.

Zde není limit, přidejte kdykoliv zaoblené linie a kruhy na vaše stěny stropy.

Index

C

C200	67
C201	71
C211 C211F	70
C212	71
C213 C213F	67
C215 C215F	67
C216	67
C217 C217F	67
C219	71
C220 C220F	67
C230 C230F	67
C240 C240F	74
C250 C250F	74
C260	74
C301	67
C303	71
C304 C304F	71
C305	70
C305 + C211	70
C305 + C213	70
C307	70
C307 + C307A	70
C308	71
C321 C321F	72
C322	67
C323	132
C324	132
C325 C325F	65
C326 C326F	65
C327	65
C331 C331F	68
C332	72
C333 C333F	68
C334 C334F	68
C335	68
C336	66
C338	66
C338A	66
C338B	66
C339 C339F	72
C340	72, 81
C341 C341F	64, 81
C342	64, 81
C343	64, 81
C344	64
C351	133
C352	133
C353	78
C354	78
C355	78
C356	78

C357	133
C358	133
C360	78
C361	142
C362	142
C364	142
C371	142
C372	142
C373 C373F	141
C374	141
C380	135
C381	135
C382	135
C383	135
C390	77, 81, 137
C391	77, 81, 137
C392	77
C393	77
C394	77, 81, 137
C395	77, 81, 137
C396	77, 81, 137
C400	78
C422	70
C602	78
C900	68, 133
C901 C901F	68, 133
C902	133
C902 C902F	68
C990	75
C990 + 2x P9900	75
C990 + P9900	75
C991	74, 81, 142
C991 + 2x P9900	74
C991 + P9900	74
CB500	87
CB501	87
CB502	87
CB503	87
CB510	87
CB511	87
CB512	87
CB520	87
CB521	87
CB522	87
CB523	87
CB524	87
CB525	87
CB530	87
CB531	87
CX100 CX100F	82
CX101	83
CX106 CX106F	82
CX107	83
CX108	82

CX109 CX109F	84
CX110 CX110F	82
CX111	82
CX112	82
CX115	84
CX123 CX123F	82
CX124 CX124F	82
CX126	84
CX127 CX127F	82
CX128	83
CX129	83
CX132 CX132F	84, 98
CX133	84, 98
CX134	112
CX141	84
CX148	84
CX154	82
CX160	86
CX161	86
CX176	84
CX177	82
CX188 CX188F	138
CX189 CX189F	138
CX190 CX190F	86, 98, 102, 112, 138
CX192	84

D

D170	151
D200	150
D210	150
D310	150
D320	153
D330LR	150
D340	150
D400	151
D401	151
D402	151
D503	151
D504	151
D506	151
D507	151
DX119-2300	110, 150
DX121-2300	110, 150
DX157-2300	150
DX163-2300	150
DX170-2300	110, 150
DX174-2300	150
DX174-2300 DX174F	110

F

F30	129
-----	-----

K

K200	153
K201	153
K202	153
K250	153
K251	153
K254	153
K1001	152
K1002	152
K1101	152
K1102	152
K1111	152
K1112	152
K1121	152
K1122	152
K1131	152
K1132	152
K1151	152
K1152	152

P

P20	115
P101A	115
P801C	115
P1020	107
P3020A	115
P3020 P3020F	107
P3070	108
P3071	108
P4020A	115
P4020 P4020F	106
P4025 P4025F	106
P5020	108
P5020B	115
P5021 P5021F	108
P6020	107
P7020	107
P7030	107
P7070 P7070F	108
P8020 P8020F	106
P8030C	115
P8030D	115
P8030 P8030F	106
P8040 P8040F	106
P8050 P8050F	106
P8060	108
P9010 P9010F	106
P9020	106
P9040	106
P9050 P9050F	108
P9900 P9900F	108
P9901	108
PB513	87
PX102	111
PX103 PX103F	111
PX103A	115
PX113	111

PX116	111
PX117	111
PX120 PX120F	111
PX120A	115
PX144 PX144F	111
PX147	112
PX164	86
PX169	112
PX175 PX175F	111

R

R07	148
R08	148
R09	148
R10	146
R11	146
R12	146
R13	147
R14	147
R17	147
R18	147
R22	147
R23	147
R24	147
R27	147
R31	147
R40	148
R52	147
R64	147
R66	148
R73	147
R76	148
R77	148

S

SX104 SX104F	95
SX105 SX105F	96
SX118 SX118F	93
SX122	94
SX125	99
SX137 SX137F	94
SX138 SX138F	94
SX155 SX155F	96
SX156	95
SX157 SX157F	86, 93, 102, 113
SX159	99, 103, 111
SX162 SX162F	86, 93, 102, 113
SX163 SX163F	86, 93, 102, 113
SX165 SX165F	93
SX168	102, 113
SX171	93, 101
SX172 SX172F	99
SX173 SX173F	93
SX179	99, 138
SX180 SX180F	97, 102
SX181	97, 102
SX182 SX182F	86, 93, 103

SX182 SX182F	113
SX183 SX183F	86, 93, 103, 113
SX184 SX184F	86, 93, 103
SX185	93, 101
SX186	93, 101
SX187 SX187F	97, 102
SX191	95
SX193	94
SX194 SX194F	86, 98, 102, 113
SX195 SX195F	96

W

W100	128
W101	128
W102	128
W103	128
W105	128
W106	128
W107	128
W108 W108F	118
W109 W109F	118
W110 W110F	118
W111	120
W112	122
W113	122
W120	126
W121	126
W122	126
W123	126
W130	120

CONCEPT

WeWantMore
Gazeuse.be

GRAPHICS

Gazeuse.be

SPECIAL THANKS TO

Sur Mesure Interieur	www.surmesure-interieur.be	4, 27, 44-45, 107
dejaegerinterieurarchitecten	www.dejaegerinterieurarchitecten.be	4-5, 18, 28-29
Marie-Emilie Geerinckx	www.marieemiliegeerinckx.be	5, 18, 136
Ligne Pure	www.lignepure.com	8
Heerenhuis Manufactuur	www.heerenhuis.be	8,12-13
Ethnicraft	www.ethnicraft.com	8, 96
Authentic and so	www.authenticandso.com	12-13
PR Living	www.prliving.com	14-15
Limited Edition	www.le.be	14-15
Taps & Baths	www.badwinkel.be	19
The Hoxton Paris	www.thehoxton.com/paris	19
Ton sur Ton	www.tonsurton.be	19, 50-51, 125
Simon De Backere	www.simondebackere.be	19, 50-51, 125
Joana Sultan_Agence Gabeli	www.agence-gabeli.fr	20,26,40,46
Atelier DAA	www.atelierdaa.com	21,24-25,41,66
Adriana Nicolau	www.adriananicolau.es	32-33
CASA DECOR Madrid	www.casadecor.es	37, 69, 79, 85, 114, 129, 143
Dica	www.dica.es	37, 69
Frederiek Van Pamel	www.frederiekvanpamel.be	38-39
WeWantMore	https://wewantmore.studio/	47
Boulangerie Henri	www.boulangerie-henri.be	52-53
Hotel Astoria	www.hotelastoria.be	54-55
Crevits Decoraties	www.crevits-decoraties.be	54-55
Danny Hoorelbeke	www.projectvijf.be	54-55
Pillows Grand Boutique Hotel Reylof	www.pillowshotels.com/ghent	56-57
Rietveld Projects	www.rietveldprojects.be	60, 97
Balo	www.balo.be	71, 92
Restaurant Du Progrès	www.duprogres.be	77
Ele Room ó2	https://eleroomó2.com/	79
Virginia Sánchez Interiorismo	www.virginiasanchezinteriorismo.com	85
Groep Versluys	www.groepversluys.be	100
Alexandra Chigintseva, Igor Gulyaev	www.chigintseva.ru	103
Virginia Gasch	http://vgliving.com/	114
Ekaterina Pozdnyakova	www.pozdnyakovadesign.ru	128
Marisa Gallo	https://interiorisimo.com/	129
Bontemps-Les Espaces;	www.bontemps.es	143
Soledad Ordóñez Giordano	www.dehuiskamer.be	146
De Huiskamer	info@nsdeco.be	146
Syngedauw Nicolas	www.palomapachecoturnes.com	32-33
Paloma Pacheco Turnes	www.bertdemasure.com	34-35,80,150
Bert Demasure	www.cafeine.be	
Cafeine	www.frederikvercruysse.com	47
Frederik Vercruysse	www.verne.be	
Verne		
& Jill, Brecht-Alexander, Laura, Leon en Heloise		

REGISTERED CTM DESIGN N°

C323/006632071-0001	C362/1890526-0002	CB502/1035273-0007	P4025/006632071-0007	SX194/008175871-0002
C324/006632071-0002	C363/1890526-0003	CB503/1890526-0005	P8050/000995576-0003	SX195/008175871-0003
C325/006632071-0003	C364/1890526-0004	CB510/1035273-0004	P8060/1810706-0002	W100/003356278-0001
C326/006632071-0004	C370/2088880-0001	CB511/1035273-0003	P9900/000995576-0004	W101/003356278-0002
C327/006632071-0005	C371/2088880-0002	CB512/1890526-0007	P9901/000995576-0005	W102/003356278-0003
C335/000995576-0001	C372/2088880-0003	CB523/1035273-0002	PB513/1890526-0006	W103/003356278-0004
C336/1035273-0001	C373/002524769-0005	CB530/1890526-0008	PX147/002341727-0003	W105/'004097780-0001
C338/1978214-0001	C374/002524769-0006	CB531/1890526-0009	PX169/002341727-0002	W106/005329026-0008
C338A/002341727-0007	C380/003242569-0001	CX176/003242569-0009	PX175/003242569-0012	W107/005329026-0009
C338B/002341727-0006	C381/003242569-0002	CX177/003242569-0010	R70/2088880-0006	W108/005329026-0010
C339/1978214-0002	C382/003242569-0003	CX188/005329026-0004	SX156/000995576-0006	W109/006379848-0001
C340/1978214-0003	C383/003242569-0004	CX189/005329026-0005	SX165/002341727-0001	W110/006379848-0002
C341/002524769-0001	C390/003242569-0005	CX190/005329026-0006	SX171/002920140-0001	W111/008175871-0004
C342/002524769-0002	C391/003242569-0006	CX192/006632071-0006	SX172/003242569-0013	W112/008175871-0005
C343/002524769-0003	C392/003242569-0007	DX168-2300/002341727-0004	SX173/003242569-0014	W113/008175871-0006
C344/002524769-0004	C393/003242569-0008	DX170/002524769-0008	SX179/003242569-0015	W120/006632071-0009
C351/000257464-0003	C394/005329026-0001	DX174-2300/003242569-0011	SX180/003242569-0016	W121/006632071-0010
C352/000257464-0004	C395/005329026-0002	DX182/'004097780-0002	SX181/003242569-0017	W122/006632071-0011
C353/000257464-0005	C396/005329026-0003	DX183/'004097780-0003	SX185/'004097780-0005	W123/006632071-0012
C354/000257464-0006	C990/000995576-0002	DX184/'004097780-0004	SX186/'004097780-0006	W130/006987111-0001
C355/000257464-0007	C991/002524769-0007	P3020A/002341727-0005	SX187/005329026-0007	
C356/000257464-0008	CB500/1035273-0006	P3070/2088880-0004	SX191/006632071-0008	
C361/1890526-0001	CB501/1035273-0005	P3071/2088880-0005	SX193/008175871-0001	

Guarantee terms and conditions apply if provided installation instructions have been followed to the letter. Fire retardant standards. In many interiors and projects strict fire regulations are imposed. Therefore, ORAC has implemented a number of solutions depending on the country and its regulations. Please contact us for more information. The information in this catalogue is without engagement. Changes and discrepancies in sizes or/and shapes against those stated in the catalogue can occur. This catalogue and the design embodied within are protected by copyright law and international treaties. Unauthorized reproduction of the catalogue, any portion of it or the reproduction of the designs embodied therein may result in severe civil and criminal penalties and will be prosecuted to the maximum. Further legal information can be found on: www.oracdecor.com/nl/disclaimer.



This catalogue is printed
on FSC-certified paper.

ITALIER

www.italier.cz | info@italier.cz | +420 774 431 196