



NEXT
ITALIER

SCAPPINI
HOME

**“UN DESIGN RACCONTA UN DIALOGO PERFETTO FRA OGNI ELEMENTO
NECESSARIO PER DARE VITA AD UNA PERFETTA SINFONIA.
LA TUA CASA, IL LUOGO DOVE RACCONTARE LA TUA STORIA...”**

“A DESIGN TELLS ABOUT THE RIGHT DIALOGUE BETWEEN EVERY
NECESSARY ELEMENT TO CREATE A PERFECT SYMPHONY.
YOUR HOME, THE PLACE WHERE TO TELL YOUR STORY...”

by Ottomani Design

SCAPPINI
HOME

WHAT'S NEXT

NEXT è la genesi dei nostri desideri, l'inizio delle nostre emozioni.

È creata per coloro che cercano forme, materia e dettagli in uno stile che unisce bellezza e funzionalità. NEXT è caratterizzata da un design asimmetrico, è uno scomposto lineare tra lucido ed opaco, tra liscio e ondulato, tra dentro e fuori. Una gamma accattivante di colori e trame donano ad ogni stanza un'atmosfera elegante e personalizzabile in ogni dettaglio. Riflessi, immagini, sensazioni.

Questo è quello che abbiamo voluto trasmettere con NEXT, un'ispirazione interamente italiana che esprime la nostra creatività e amore per il bello.

WHAT'S NEXT

NEXT is the genesis of our desires, the beginning of our emotions.

It is created to meet the research for shapes, material and details in a style which combines beauty and functionality. NEXT collection is characterized by an asymmetrical design, it is a linear breaking up between glossy and matt, smooth and wavy, inside and outside. A captivating range of colours and textures give to every room an elegant atmosphere, customizable in every single detail. Reflections, images, sensations.

This is what we wanted to convey with NEXT, an original Italian inspiration that expresses our creativity and love for beauty.

MATERIALI DI PREGIO E INNOVAZIONE TECNOLOGICA

La ricercatezza dei materiali ed il loro sapiente accostamento, contraddistinguono la collezione.

Essenze, vernici laccate lucide ed opache, enfatizzate dal motivo del canneté, metalli e marmi ricercati, dettagli in cuoio con impunture a due aghi, velluti e tessuti in vari colori e trame, soffice nabuk e specchi fumé. Vetri colorati e un'innovativa tecnica di stampa digitale che permette di riprodurre fedelmente immagini, texture, materiali naturali e qualsiasi immagine che possa essere fotografata e scansionata in alta definizione, a richiesta del cliente finale.

QUALITY MATERIALS AND TECHNOLOGICAL INNOVATION

The research for materials and their wise combination, distinguish this collection.

Essences of wood, glossy and matt lacquers, enhanced by the canneté wooden pattern, metals and special marbles, leather details with two-needle stitching, velvet and fabrics in different colours and textures, soft nubuck and smoked mirrors. Painted glasses and an innovative digital print technique which accurately reproduces images, textures, natural materials and anything that can be photographed or scanned in high definition, upon customer request.

QUANDO CI CHIEDIAMO..."BENE, QUAL È IL PROSSIMO PASSO?"
SIGNIFICA CHE SIAMO PRONTI A VOLTARE PAGINA.

E VOI? SIETE PRONTI?

WHEN WE ASK OURSELVES..."OK, WHAT'S NEXT?"
IT MEANS THAT WE'RE READY TO MOVE ON TO OTHER THINGS!
AND YOU? ARE YOU READY FOR NEXT?

Chiara, Lorenzo, Giovanni Scappini



LIVING

"UN BUON DIVANO È SPESSO CIÒ CHE C'È DI PIÙ EFFICACE PER IMBASTIRE UNA CONVERSAZIONE."

"A GOOD SOFA IS OFTEN THE MOST EFFECTIVE WAY TO STRIKE UP A CONVERSATION."

Pierre Duc, Arrières-pensées





**LINEE RIGOROSE E CURVE
SINUOSE SI EQUILIBRANO NEGLI
ELEMENTI DELLA COLLEZIONE.
IL METALLO SOSTIENE IL COMFORT
DEL DIVANO, LE GAMBE ESILI
SOSPONDONO LA CONSOLLE,
IL MOTIVO CANNETÉ ALLEGGERISCE
IL MOBILE PORTA TV.**

STRICT LINES AND SINUOUS CURVES
BALANCE EACH OTHER AMONG THE
ELEMENTS OF THIS COLLECTION:
THE METAL SUPPORTS THE COMFORT
OF THE SOFA, THE SLIGHT LEGS
SUSPEND THE CONSOLLE, THE CANNETÉ
WOODEN PATTERN LIGHTENS
THE TV CABINET.







Divano OVER, Consolle AROUND, Piantana FLAMINGO, Pouf EASY, Tavolini SHORT e MID, Lampada da appoggio COLIBRI
OVER Sofa, AROUND Console, FLAMINGO Floor lamp, EASY Pouf, SHORT Coffee table, MID Occasional table, COLIBRI Table lamp



Divano OVER, Pouf per divano EXTRA, Piantana HERON
 OVER Sofa, EXTRA Sofa pouf, HERON Floor lamp



**I RIVESTIMENTI IN TESSUTI
 MATERICI E PREZIOSI ESALTANO
 LE FORME. LA PRESENZA DI
 DIVERSE CROMIE È UN OMAGGIO
 ALL'ELEGANZA E SOTTOLINEA
 LA DELICATEZZA DEL DESIGN.**
 THE UPHOLSTERY WITH RICH
 FABRICS ENHANCES THE SHAPES.
 THE COMBINATION OF DIFFERENT
 COLOURS IS A TRIBUTE TO
 ELEGANCE AND EMPHASIZES
 THE DELICACY OF THE DESIGN.





Tavolini UP, MID e SHORT, Piantana FLAMINGO
UP, MID Occasional tables, SHORT Coffee table, FLAMINGO Floor lamp



Mobile bar LOUNGE, Piantana FLAMINGO, Poltrona SMOKE
LOUNGE Bar unit, FLAMINGO Floor lamp, SMOKE Armchair



**IL MOBILE COMPONE IL CANNETÉ
CON L'ESSENZA DI EBANO. IL TOP
È IN VETRO LACCATO CON PROFILO
VERNICIATO OTTONE. ALL'INTERNO
ACCESSORI UTILI E DETTAGLI
PREZIOSI ILLUMINATI CON LUCI LED
CON SENSORE DI APERTURA.**

THE BAR UNIT COMBINES THE
CANNETÉ WOODEN PATTERN
WITH THE EBONY ESSENCE.
LACQUERED GLASS TOP WITH BRASS
VARNISHED PROFILE. INSIDE USEFUL
ACCESSORIES AND PRECIOUS DETAILS
ILLUMINATED WITH OPENING
SENSOR LED LIGHT.





Consolle AROUND, Lampada da appoggio COLIBRÌ, Pouf EASY
AROUND Console, COLIBRÌ Table lamp, EASY Pouf





**IL MOBILE LIBRERIA,
IN ESSENZA DI EBANO, PRESENTA
DIVISORI IN METALLO VERNICIATO
OTTONE CON PIANI IN VETRO FUMÉ,
ILLUMINATI A LED. LA LIBRERIA,
RACCHIUDE IL MOBILE PORTA TV.
EQUIPPED WALL UNIT
IN EBONY ESSENCE WITH BRASS
LACQUERED METAL DIVIDERS, SMOKE
GLASS TOPS WITH LED LIGHT.
THE WALL UNIT IS THE PERFECT FRAME
FOR THE TV CABINET.**







Poltrona SMOKE, Piantana FLAMINGO
SMOKE Armchair, FLAMINGO Floor lamp



LA POLTRONA, RIVESTITA IN MORBIDA PELLE, HA UN ASPETTO INVITANTE E UN CARATTERE LUSUOSO, ENFATIZZATI DA VOLUMI MARCATI. IL POGGIATESTA IN PELLE PUÒ ESSERE POSIZIONATO PER IL MASSIMO COMFORT.
THE ARMCHAIR, COVERED WITH SOFT LEATHER, HAS AN INVITING APPEARANCE AND A LUXURIOUS CHARACTER ENHANCED BY MARKED VOLUMES. THE HEADREST CAN BE POSITIONED FOR THE MAXIMUM COMFORT.

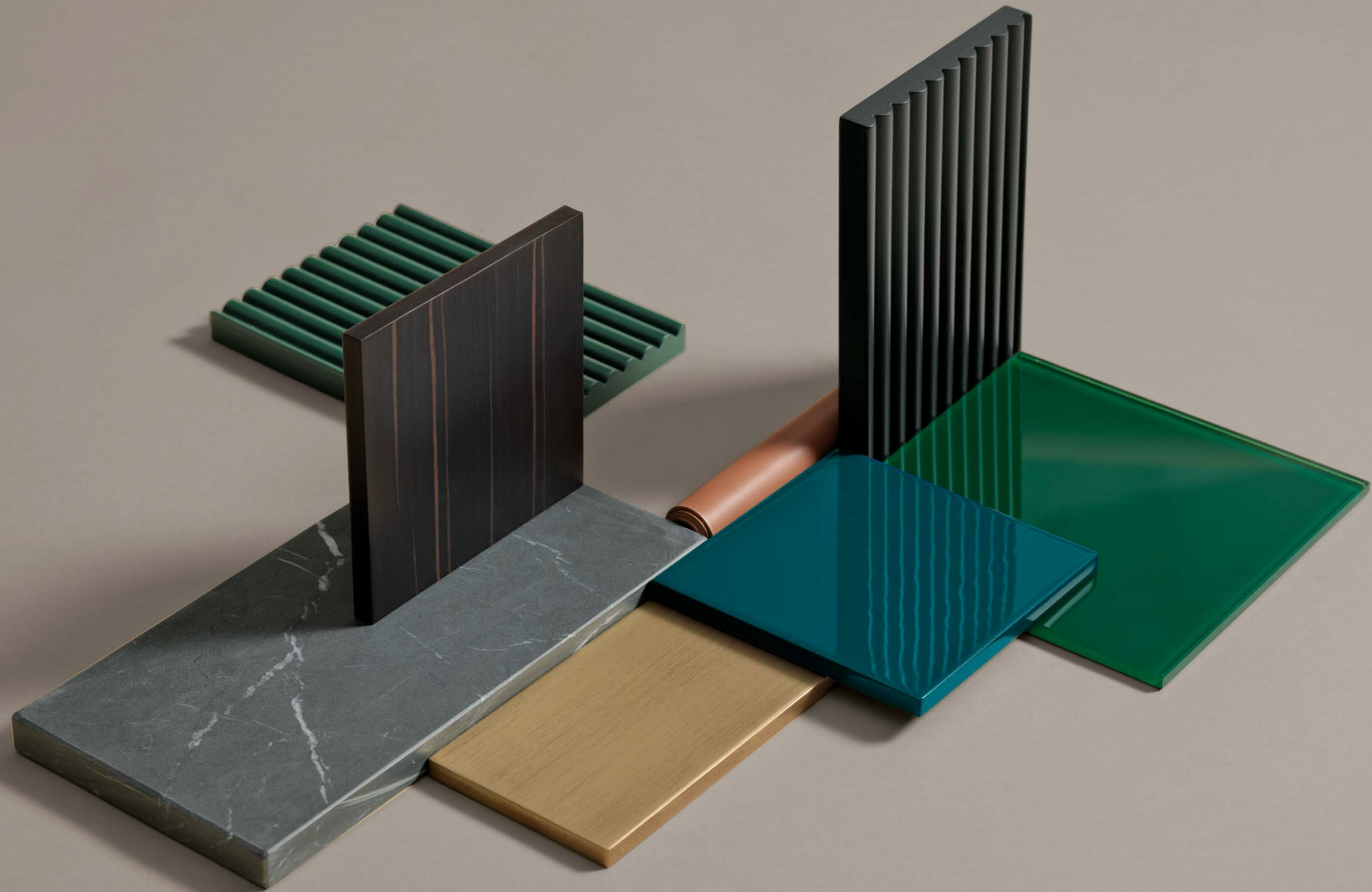

DINING

"NON SI PUÒ PENSARE BENE, AMARE BENE, DORMIRE BENE, SE NON SI HA MANGIATO BENE."

"ONE CANNOT THINK WELL, LOVE WELL, SLEEP WELL, IF ONE HAS NOT DINED WELL."

Virginia Woolf





COLORI DECISI DANNO ALLA COLLEZIONE UNO STILE FORTE E RICONOSCIBILE. METALLO, LEGNI, MARMI, CUIO, VETRI LACCATI SI COMPONGONO IN UN DESIGN DI SPICCATÀ PERSONALITÀ.

DEFINITE COLOURS GIVE TO THE COLLECTION A STRONG AND RECOGNIZABLE STYLE. METALS, WOOD ESSENCES, MARBLES, LEATHER, LACQUERED GLASSES, COMBINE THEMSELVES INTO A DESIGN OF SHARP PERSONALITY.

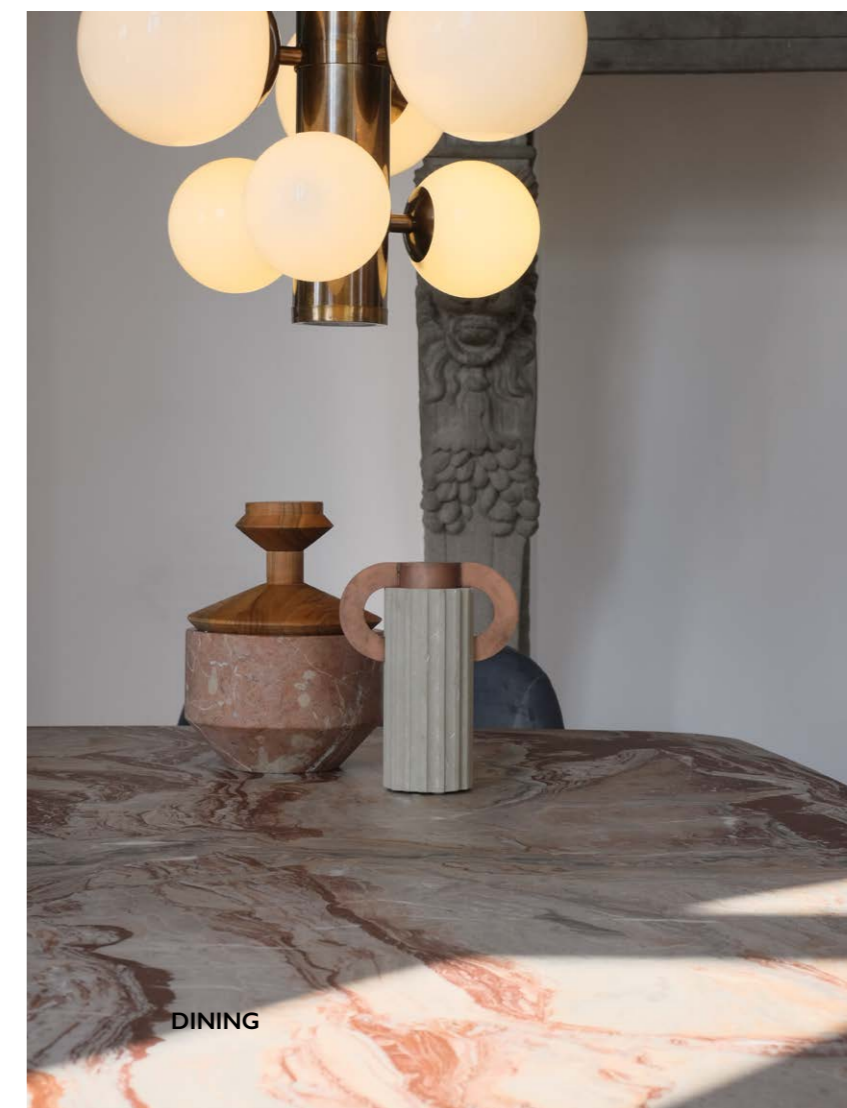





Sedia EMBRACE, Tavolo ROCK, Piantana FLAMINGO
EMBRACE Chair, ROCK Table, FLAMINGO Floor lamp



**IL SOTTILE PIANO DEL TAVOLO,
IN MARMO OROBICO ROSSO SI
FA NOTARE PER LA SUA DECISA
DELICATEZZA. LA POLTRONCINA
HA LO SCHIENALE IN PELLE,
CON IMPUNTURE A DUE AGHI.
THE THIN OROBIC RED MARBLE
TOP MAKES ITSELF NOTICE FOR ITS
STRONG DELICACY. THE ARMCHAIR
IS BACK UPHOLSTERED WITH
TWO-NEEDLE STITCHING LEATHER.**

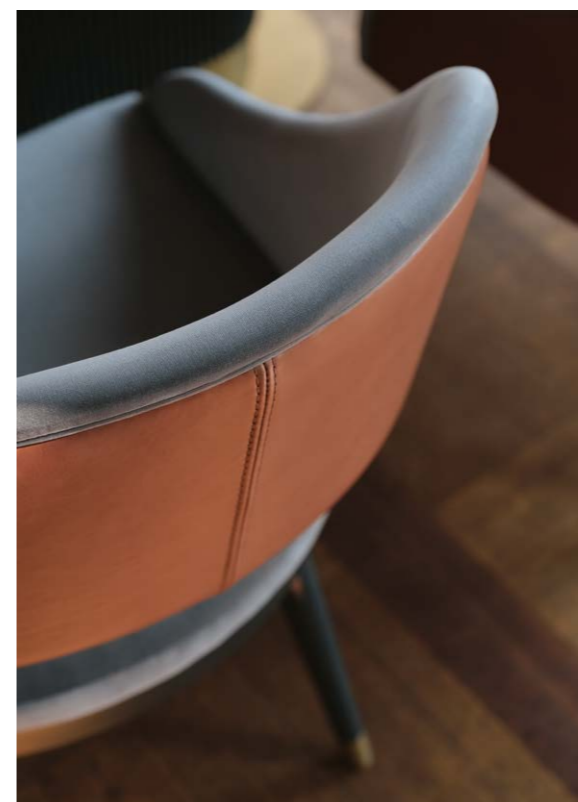





Tavolo FUTURE, Sedia EMBRACE, Credenza FACE, Lampada da appoggio EAGLE, Pouf EASY, Piantana HERON
FUTURE Table, EMBRACE Chair, FACE Sideboard, EAGLE Table lamp, EASY Pouf, HERON Floor Lamp



**L'AMORE PER L'INNOVAZIONE
HA DATO VITA AD UN PIANO
IN VETRO CON STAMPA
DIGITALE DI ALTISSIMO
LIVELLO CHE CONDUCE LO
SGUARDO A MIRABILI EFFETTI
DI PROFONDITÀ.**

LOVE FOR INNOVATION
GAVE LIFE TO A GLASS TOP
WITH HIGH LEVEL DIGITAL
PRINT THAT LEADS THE GAZE TO
AMAZING EFFECTS OF DEPTH.

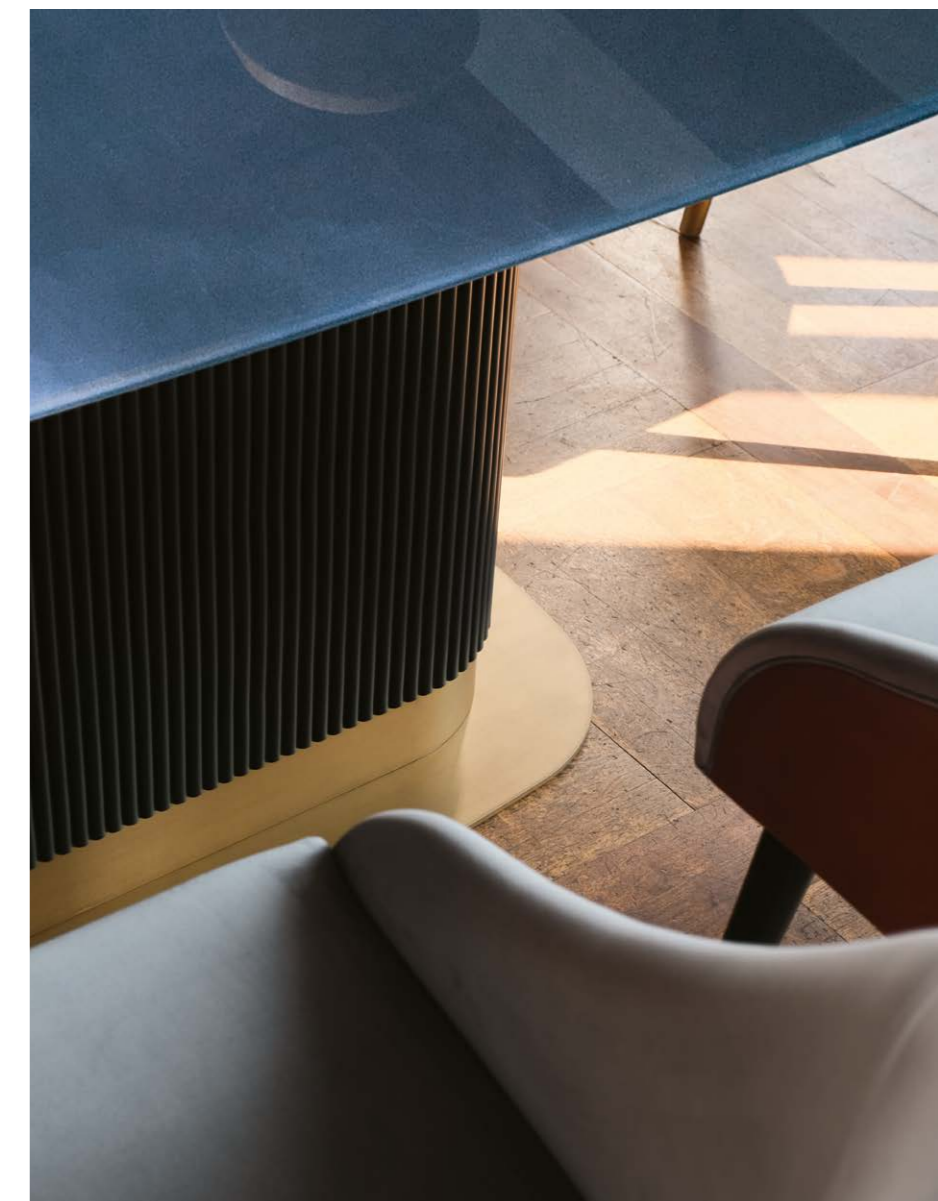





Credenza FACE, Lampada da da appoggio EAGLE
FACE Sideboard, EAGLE Table lamp



**IMPORTANTE MA FINE
ED ELEGANTE, LA CREDENZA
COMPONE DUE VOLTI:
UNA SOLIDITÀ ESTERIORE CHE
RACCHIUDE UN SOFISTICATO
EQUILIBRIO INTERNO DI LUCE,
COLORE E RIFLESSI.**

IMPORTANT BUT REFINED
AND ELEGANT, THE SIDEBOARD
MATCHES TWO FACES:
AN EXTERIOR SOLIDITY THAT
HIDES A SOPHISTICATED INNER
BALANCE OF LIGHT, COLOUR
AND REFLECTIONS.



**LA VETRINA SMART SI
CONNOTA PER LA SUA GRANDE
ATTUALITÀ, QUASI SEGUISSE
LE SUGGERZIONI DELLA MODA.
L'INTERNO VIENE VALORIZZATO
DAL CUIO APPLICATO
DA ABILI TAPPEZZIERI ARTIGIANI.**
SMART VITRINE IS DISTINGUISHED
FOR ITS GREAT TOPICAL, AS IF IT
FOLLOWED THE SUGGESTIONS
OF FASHION. THE INTERIOR IS
ENHANCED BY THE BACK LEATHER
APPLIED BY SKILLFUL UPHOLSTERERS.



NIGHT

"C'È UN TEMPO PER I LUNGI RACCONTI, E UN TEMPO PER DORMIRE."

"THERE IS A TIME FOR MANY WORDS, AND THERE IS ALSO A TIME FOR SLEEP."

Omero





**IL LETTO SI IMPONE CON
LA SUA IMPORTANTE TESTATA
IMPUNTURATA VERTICALMENTE,
RIPRENDE IL MOTIVO CANNETÉ
DEGLI ARREDI DELLA COLLEZIONE.**

BED STANDS OUT WITH ITS
IMPORTANT HEADBOARD, VERTICALLY
HAND-SEWN, REMINDING THE
CANNETÉ PATTERN OF THE
FURNISHINGS OF THE COLLECTION.







Letto BOND, Toilette FANCY, Piantana FLAMINGO, Comodino AWAY, Lampada da appoggio integrata SWAN
BOND Bed, FANCY Vanity desk, FLAMINGO Floor lamp, AWAY Bedside table, SWAN Built-it table lamp



**DETTAGLIO IMPORTANTE
È LA FUNZIONALITÀ DELLA
LAMPADA INGLOBATA NEL
COMODINO, CON PULSANTE
TOUCH. LA PANCA È RIVESTITA
IN PELLE CON CORNICE
VERNICIATA OTTONE.**

AN IMPORTANT DETAIL IS
THE PRACTICALITY OF THE TABLE
LAMP INCLUDED IN THE NIGHT
TABLE, WITH TOUCH-BUTTON.
BENCH IS UPHOLSTERED IN LEATHER
WITH A BRASS LACQUERED
PROFILE AT ITS BASE.





Panchetta BOUNCE
BOUNCE Bench

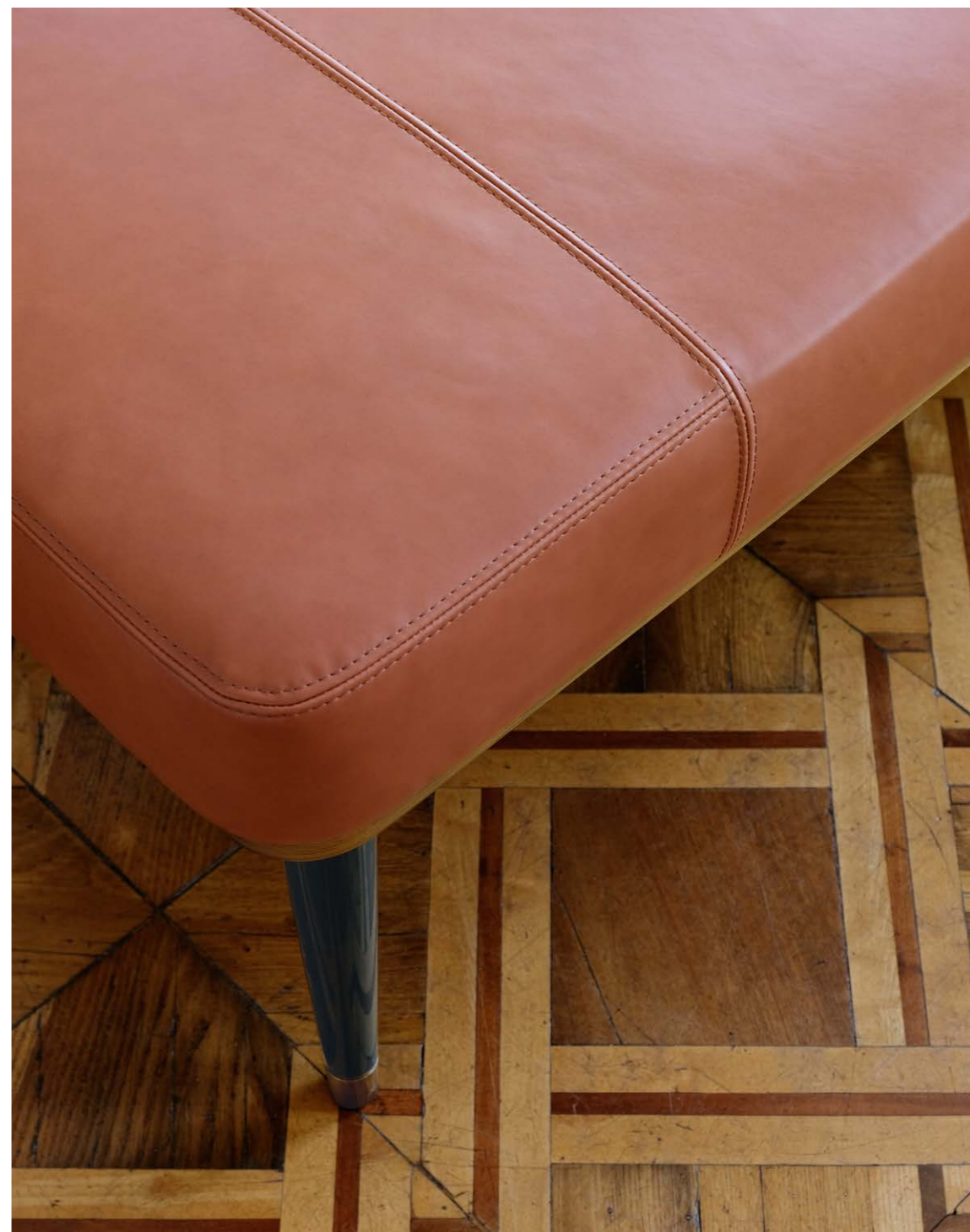



Toilette FANCY, Pouf EASY, Piantana FLAMINGO
FANCY Vanity desk, EASY Pouf, FLAMINGO Floor lamp

Toilette FANCY, Pouf EASY, Piantana FLAMINGO, Scatola TREASURE
FANCY Vanity desk, EASY Pouf, FLAMINGO Floor lamp, TREASURE box



**LA TOILETTE, IN LINEA CON
L'INTERA COLLEZIONE SI
VESTE DI UN PIANO IN VETRO
LACCATO; LO SCHIENALE DELLA
SPECCHIERA È GENIALMENTE
ADIBITO AD APPENDIABILI.**

VANITY DESK, IN LINE WITH
THE ENTIRE COLLECTION, IS
COMPLETED BY A LACQUERED
GLASS TOP. THE BACK OF ENCLOSED
MIRROR IS BRILLIANTLY EQUIPPED
WITH CLOTHES-HANGERS.

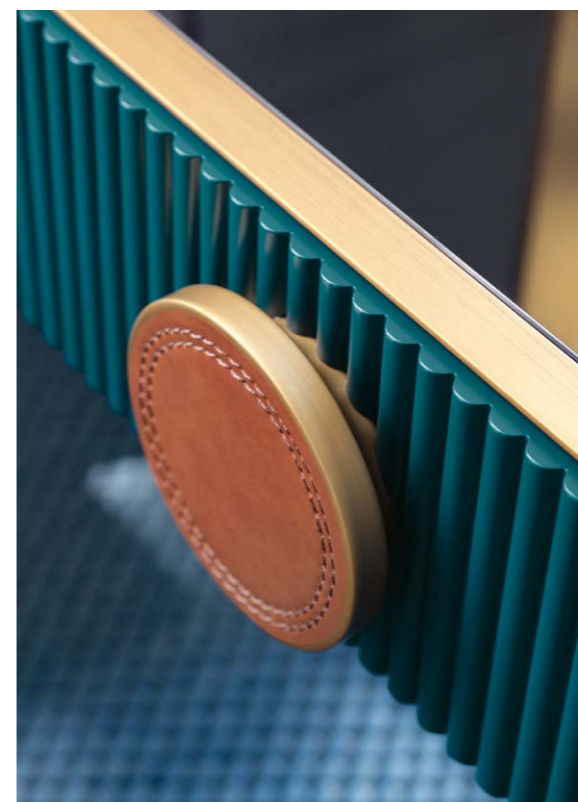



**RIPOSANTE E DISCRETA, LA TENUE
COLORAZIONE GRIGIO AGATA ADATTA
IL DESIGN DELLA COLLEZIONE ALLA
NOTTE, PUR SENZA TRADIRNE LE
FORME E I SEGNI PIÙ DISTINTIVI.**

RESTFUL AND DISCREET,
THE DELICATE AGATE GREY COLOUR SUITS
THE DESIGN OF THE COLLECTION
TO THE NIGHT, PRESERVING ITS SHAPES
AND ITS MOST DISTINGUISH MARKS.









Tavolini UP e MID, Piantana HERON
UP and MID Occasional tables, HERON Floor lamp





INFORMAZIONI TECNICHE DEI PRODOTTI

PRODUCTS TECHNICAL DATA

OVER N14

divano
sofa

MISURE DIMENSIONS
280x95xH 67 cm

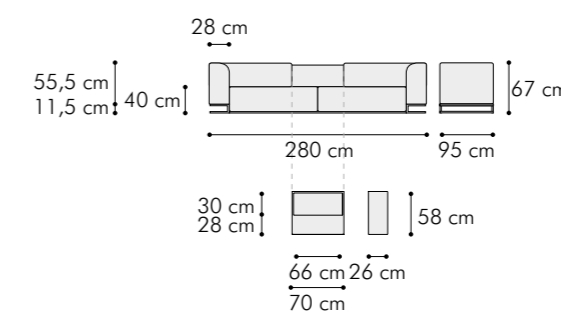

Divano 3 posti
Schienale equipaggiato con etagere impiallacciato EBONY, opaco
Tessuto: AZI-GL 501, cat. 1
Base: metallo finitura OTTONE
Cuscini non inclusi (vedi pagina 106-107)

Il divano può essere ordinato con schienale completamente imbottito, senza etagere Codice art. OVERALL - N14FB

3 Seater sofa
Back equipped with etagere EBONY veneered, matt
Fabric: AZI-GL-501, cat.1
Base: metal BRASS finish
Small cushions not included (see pages 106-107)

The sofa is also available with back fully upholstered, without etagere
Code art. OVERALL - N14FB



PAG.14-20

EXTRA N15

pouf per divano
sofa pouf

MISURE DIMENSIONS
115x75xH 40 cm

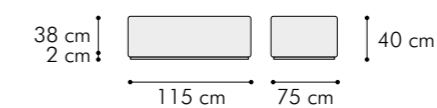

Pouf per divano
Tessuto: AZI-GL 501, cat. 1
Base: metallo finitura OTTONE

Sofa pouf
Fabric: AZI-GL-501, cat.1
Base: metal BRASS finish



PAG.18-19

LOUNGE N06

mobile bar
bar unit

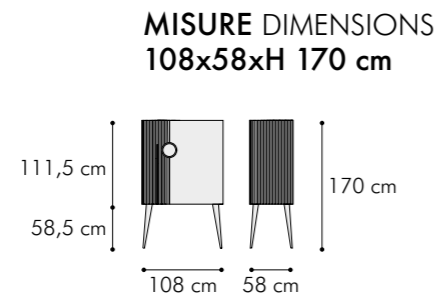

Mobile bar a 2 ante
Fianco/anta sinistri: canneté 7026 GRIGIO GRANITO, opaco
Fianco/anta destri: impiallacciati EBONY, opaco
Top vetro laccato 7010 GRIGIO TENDA con profilo finitura OTTONE
Gambe: 7026 GRIGIO GRANITO, brillante
Puntali finitura OTTONE
Maniglia con inserto in cuoio con impuntura a due aghi
Interno: 7038 GRIGIO AGATA, opaco
Equipaggiamento interno:
2 cassetti laterali apertura push-pull con fondino ecopelle TAN320
1 ripiano centrale estraibile push-pull con top specchio
1 ripiano in legno - 2 ripiani in vetro fumé
1 porta-calici finitura OTTONE a 3 corsie
Schienale specchio a listelli
Illuminazione LED con sensore di apertura

Bar unit with 2 doors
Left side/door: canneté 7026 GRANITE GREY, matt
Right side/door: EBONY veneered, matt
Lacquered glass top 7010 TARPULIN GREY with BRASS finish profile
Legs: 7026 GRANITE GREY, glossy
BRASS polished feet
Handle with two-needle stitching leather insert
Inside: 7038 AGATE GREY, matt
Inner equipment:
2 push-pull side drawers, inside bottom uph. eco-leather TAN320
1 push-pull center serving shelf with mirror on top
1 wooden shelf - 2 smoke glass shelves
3 rails wine glasses BRASS holder
Mirror with strips on back
LED lights with opening sensor

PAG.14-15, 22-25

CLEVER N08

libreria
equipped wall unit

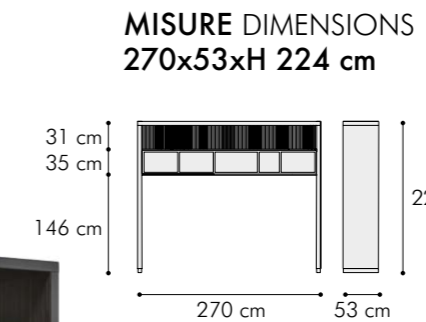

Libreria con 2 ripiani
Impiallacciata EBONY, opaco
Schienale dietro ripiano superiore con canneté 7026 GRIGIO GRANITO, opaco
Ripiano inferiore accessorizzato con divisori in metallo finitura OTTONE, con fondo in vetri fumé
Illuminazione LED su ripiano inferiore

Equipped wall unit with 2 shelves
EBONY veneered, matt
Canneté 7026 GRANITE GREY, matt, on back of upper shelf
Lower shelf equipped with metal BRASS polished dividers, bottom smoke glasses
LED light on lower shelf

PAG.28-31

AROUND N13

consolle
console

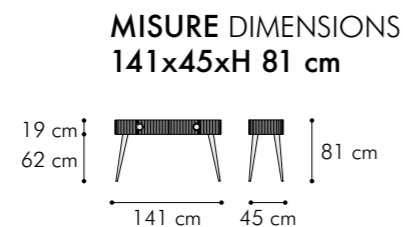

Consolle con 1 cassetto
7026 GRIGIO GRANITO, opaco
Top vetro laccato 6005 VERDE MUSCHIO, profilo finitura OTTONE
Gambe: 7026 GRIGIO GRANITO, brillante
Puntali finitura OTTONE
Fondino cassetto in ecopelle TAN320 con impuntura a due aghi
Maniglie con inserto in cuoio con impuntura a due aghi

Console table with 1 drawer
7026 GRANITE GREY, matt
Lacquered glass top 6005 MOSS GREEN with BRASS finish profile
Legs: 7026 GRANITE GREY, glossy
BRASS polished feet
Inside bottom of drawer upholstered with eco-leather TAN320 with two-needle stitching
Handles with two-needle stitching leather insert

PAG.16-17, 26-27

WIDE N07

base per TV
TV unit



MISURE DIMENSIONS
222x57xH 51 cm

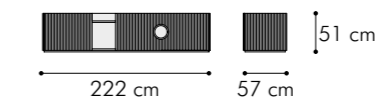

Base per TV a 3 ante, 4 vani
7026 GRIGIO GRANITO, opaco
Top in vetro laccato 7010 GRIGIO TENDA con profilo finitura OTTONE
Vano a giorno con ripiano regolabile in legno
1 ripiano regolabile in vetro fumé dentro anta centrale e destra
Maniglia con inserto in cuoio con impuntura a due aghi

TV unit with 3 doors, 4 spaces
7026 GRANITE GREY, matt
Lacquered glass top 7010 TARPULIN GREY with BRASS finish profile
Open space with adjustable wooden shelf
1 adjustable smoke glass shelf behind central and right door
Handle with two-needle stitching leather insert

PAG.28-33

SMOKE N16

poltrona
armchair

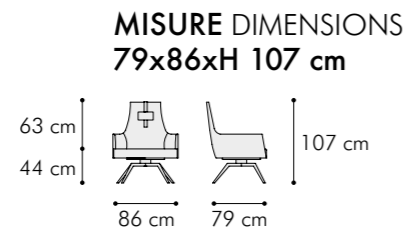

Poltrona
Base: metallo finitura OTTONE
Rivestimento: pelle DAK-DI 0229, cat. A
Poggiatesta: pelle DAK-DI 0229, cat. A
Cuscino poggiatesta non incluso (vedi pagina 106)

Armchair
Base: metal BRASS finish
Upholstery: leather DAK-DI 0229, cat. A
Headrest: leather DAK-DI 0229, cat. A
Loin-rest cushion not included (see page 106)

PAG.24, 34-35

EMBRACE N05

sedia
chair

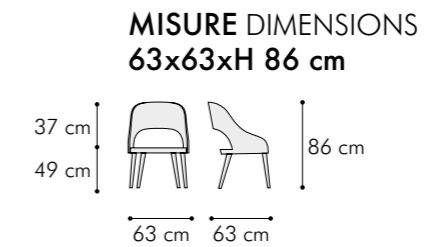

Sedia
Rivestimento esterno: pelle DAK-DI 0229, cat. A
Rivestimento interno: tessuto AZI-GL 803, cat.1
Fondo/gambe: 7026 GRIGIO GRANITO, brillante
Puntali in OTTONE

Chair
Outside upholstery: Leather DAK-DI 0229, cat. A
Inside upholstery: fabric AZI-GL 803, cat.1
Bottom/legs: 7026 GRANITE GREY, glossy
BRASS feet

PAG.42-51

ROCK N03

tavolo top marmo
marble top table

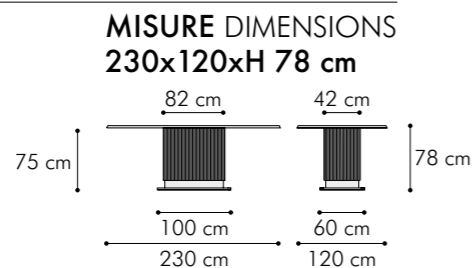

Tavolo da pranzo con top marmo OROBICO ROSSO, opaco
Piedistallo in canneté 7026 GRIGIO GRANITO, opaco
Piastra in metallo finitura OTTONE

Disponibile con altri tipi di marmo, vedi pagina 113

Dining table with OROBIC RED marble top, matt
Base with canneté 7026 GRANITE GREY, matt
BRASS polished metal platform.

Available with different marble tops, see page 113

PAG.42-47

FUTURE N04

tavolo top vetro con stampa digitale
digital printed glass top table

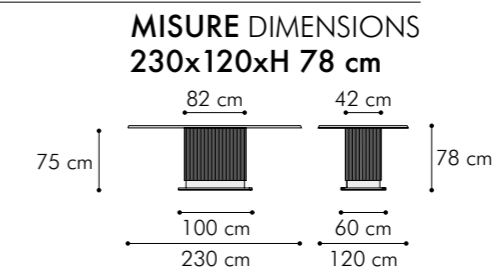
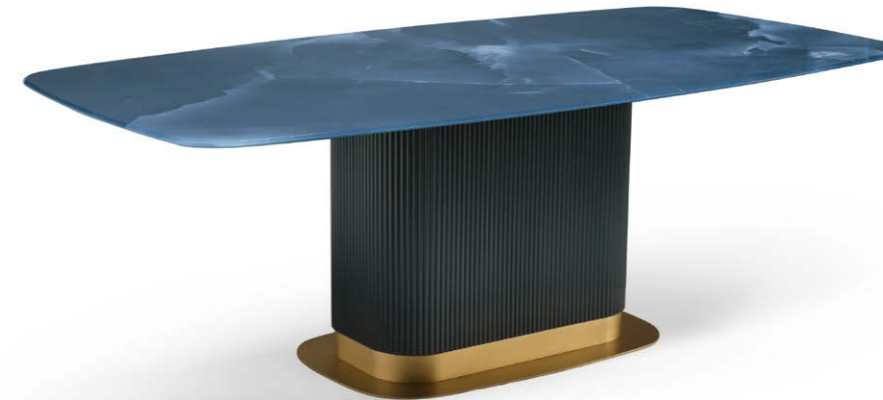

Tavolo da pranzo con top in vetro con stampa digitale BLUE SKY
Piedistallo in canneté 7026 GRIGIO GRANITO, opaco
Piastra in metallo finitura OTTONE

Top in vetro stampato disponibile in altri colori, vedi pagina 113

Dining table with high definition digital printed glass top, BLUE SKY
Base with canneté 7026 GRANITE GREY, matt
BRASS polished metal platform

Digital printed glass top available in different colours, see page 113

PAG.48-51

FACE N01

credenza
sideboard

MISURE DIMENSIONS
220x50xH 89 cm

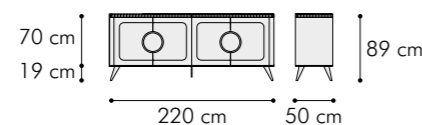

Credenza 4 porte, 2 vani
7026 GRIGIO GRANITO, opaco
Top in vetro laccato 5004 BLU NERASTRO con profilo
finitura OTTONE
Gambe 7026 GRIGIO GRANITO, brillante
Puntali finitura OTTONE
Maniglie con inserto in cuoio con impuntura a due aghi
Interno: 8004 MARRONE RAME, opaco
1 ripiano regolabile in vetro fumé dentro ciascun vano
Illuminazione LED con sensore di apertura

4 doors sideboard, 2 spaces
7026 GRANITE GREY, matt
Lacquered glass top 5004 BLACK BLUE with BRASS finish profile
Legs 7026 GRANITE GREY, glossy
BRASS polished feet
Handles with two-needle stitching leather insert
Inside: 8004 COPPER BROWN, matt
1 adjustable smoke glass shelf behind each space
LED light with opening sensor



PAG.48-50, 54-57

BOND N17

letto
bed

MISURE DIMENSIONS
216x221xH 30/151 cm

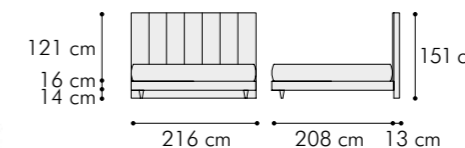

Letto imbottito
Testata letto con inserto laterale in canneté
7038 GRIGIO AGATA, opaco e profilo finitura OTTONE
Gambe: 7038 GRIGIO AGATA, brillante
Puntali finitura OTTONE
Rivestimento: Nabuk MON-DI 0855, cat. B
Giroletto con supporti angolari per rete in metallo
Per rete/materasso misura cm.200x200
Disponibile su richiesta per qualsiasi misura di rete/materasso

Rete, materasso e coordinato letto sono esclusi

Upholstered bed
Headboard with side canneté wooden pattern insert
7038 AGATE GREY, matt and BRASS finish profile
Legs: 7038 AGATE GREY, glossy
BRASS polished feet
Covering: Nubuck MON-DI 0855, cat. B
Bedbox with corner metal supports for slat
For slat/mattress size cm.200x200
Available upon request for any size of slat/mattress

Slat, mattress, bed linen are not included

PAG.66-69, 74-77

SMART N02

vetrina
vitrine

MISURE DIMENSIONS
135x43xH 168 cm

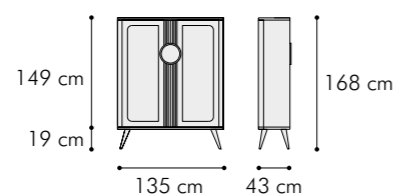

Vetrina a 2 ante.
7026 GRIGIO GRANITO, opaco
Gambe 7026 GRIGIO GRANITO, brillante
Puntali finitura OTTONE
Maniglie con inserto in cuoio con impuntura a due aghi
Interno: schienale rivestito in ecopelle TAN320
con impuntura a due aghi
2 ripiani regolabili in vetro fumé
Illuminazione LED con sensore di apertura

2 doors vitrine
7026 GRANITE GREY, matt
Legs 7026 GRANITE GREY, glossy
BRASS polished feet
Handles with two-needle stitching leather insert
Inside: back upholstered with eco-leather TAN320
with two-needle stitching
2 adjustable smoke glass shelves
LED light with opening sensor



PAG.58-59

AWAY N18

comodino
bedside table

MISURE DIMENSIONS
66x45xH 58 cm

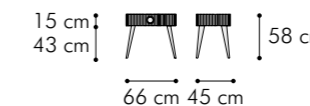

Comodino con 1 cassetto
Laccato 7038 GRIGIO AGATA, opaco
Top vetro laccato 7010 GRIGIO TENDA, profilo finitura OTTONE
Gambe: 7038 GRIGIO AGATA, brillante
Puntali finitura OTTONE
Fondino cassetto in ecopelle TAN320 con impuntura a due aghi
Maniglia con inserto in cuoio con impuntura a due aghi

Night table with 1 drawer
7038 AGATE GREY, matt lacquered
Lacquered glass top 7010 TARPAULIN GREY, with BRASS finish profile
Legs 7038 AGATE GREY, glossy
BRASS polished feet
Inside bottom of drawer upholstered with eco-leather TAN320
with two-needle stitching
Handle with two-needle stitching leather insert

PAG.66-69, 76-77

FANCY N21

toilette con specchio
vanity desk with built-in mirror

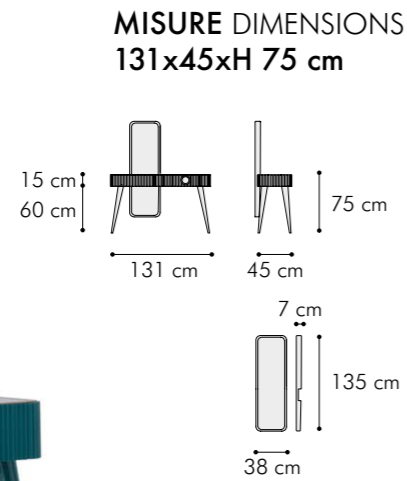

Toilette con specchio incorporato
Laccato 5020 BLU OCEANO, opaco
Top in vetro laccato 5004 BLU NERASTRO con profilo
finitura OTTONE
Gambe 5020 BLU OCEANO, brillante, puntali finitura OTTONE
1 cassetto lato destro, con fondino ecopelle TAN320
con impuntura a due aghi
Maniglia con inserto in cuoio con impuntura a due aghi
Cornice specchio finitura OTTONE, retro rivestito in ecopelle TAN320
con impuntura a due aghi e 2 ganci attaccapanni in OTTONE

Vanity desk with built-in mirror
5020 OCEAN BLUE, matt
Lacquered glass top 5004 BLACK BLUE with BRASS finish profile
Legs 5020 OCEAN BLUE, glossy, BRASS polished feet
1 right drawer with inside bottom eco-leather TAN320
with two-needle stitching
Handle with two-needle stitching leather insert
Built-in mirror with BRASS finish frame, back upholstered
with eco-leather TAN320 with two-needle stitching
and 2 BRASS clothes-hangers

PAG.66-68, 72-75

GAZE N20

specchio per comò
mirror for chest of drawers



MISURE DIMENSIONS
80x5xH 90 cm

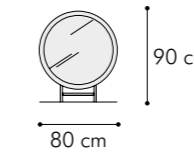

Specchio per comò
Metallo finitura OTTONE

Può essere fissato in qualsiasi punto dello schienale del comò

Mirror for chest of drawers
Metal BRASS finish

The mirror can be fixed in any position of back of chest of drawers

PAG.76, 78-81

DOUBLE N19

comò
chest of drawers

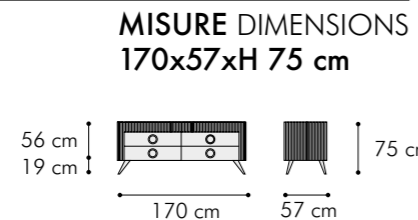
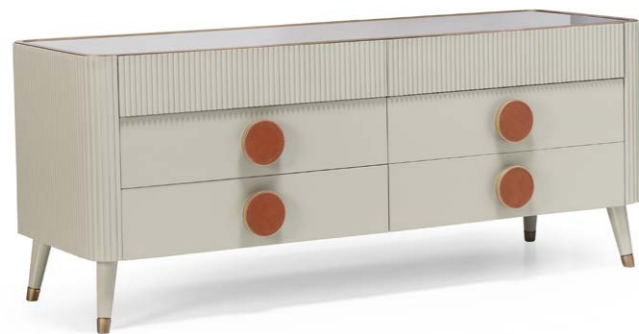

Comò con 6 cassetti
7038 GRIGIO AGATA, opaco
Top vetro laccato 7010 GRIGIO TENDA, profilo finitura OTTONE
Gambe: 7038 GRIGIO AGATA, brillante
Puntali finitura OTTONE
Cassetti superiori con apertura push-pull
Fondini cassetti in ecopelle TAN320 con impuntura a due aghi
Maniglie con inserto in cuoio con impuntura a due aghi

Chest with 6 drawers
7038 AGATE GREY, matt
Lacquered glass top 7010 TARPULIN GREY with BRASS finish profile
Legs: 7038 AGATE GREY, glossy
BRASS polished feet
Upper drawers with push-pull opening
Inside bottom of drawers upholstered with eco-leather TAN320
with two-needle stitching
Handles with two-needle stitching leather insert

PAG.76, 78-83

BOUNCE N22

panchetta
bench



MISURE DIMENSIONS
153x58xH 53 cm

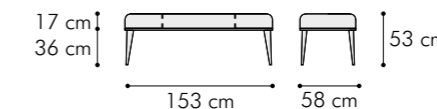

Panchetta
Rivestimento: pelle DAK-DI 0229, cat. A con impunture a due aghi
Fondo finitura OTTONE
Gambe: 7026 GRIGIO GRANITO, brillante
Puntali finitura OTTONE

Bench
Leather DAK-DI 0229, cat. A with two-needle stitching
Bottom BRASS polished
Legs: 7026 GRANITE GREY, glossy
BRASS polished feet

PAG.66-67, 70-71

INFINITY N24-300 / N24-200

armadio
wardrobe

MISURE DIMENSIONS
300x60xH 250 cm
200x60xH 250 cm

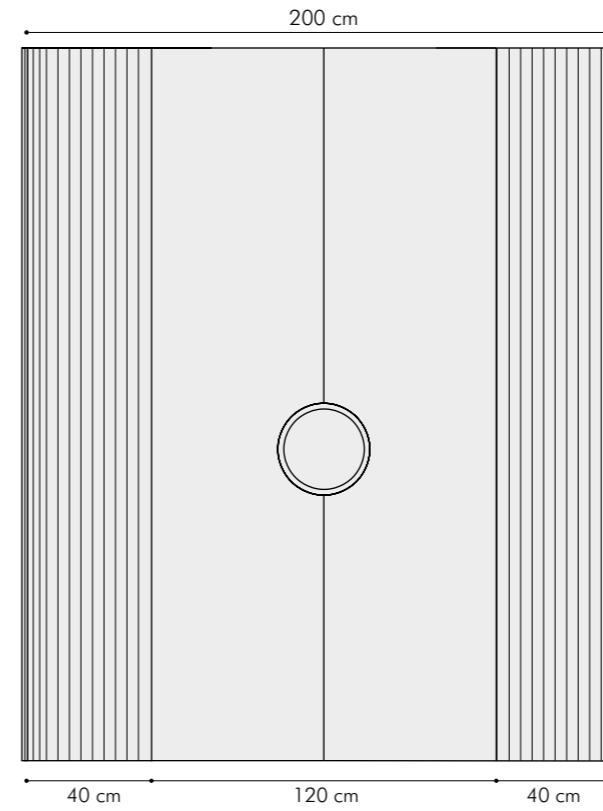
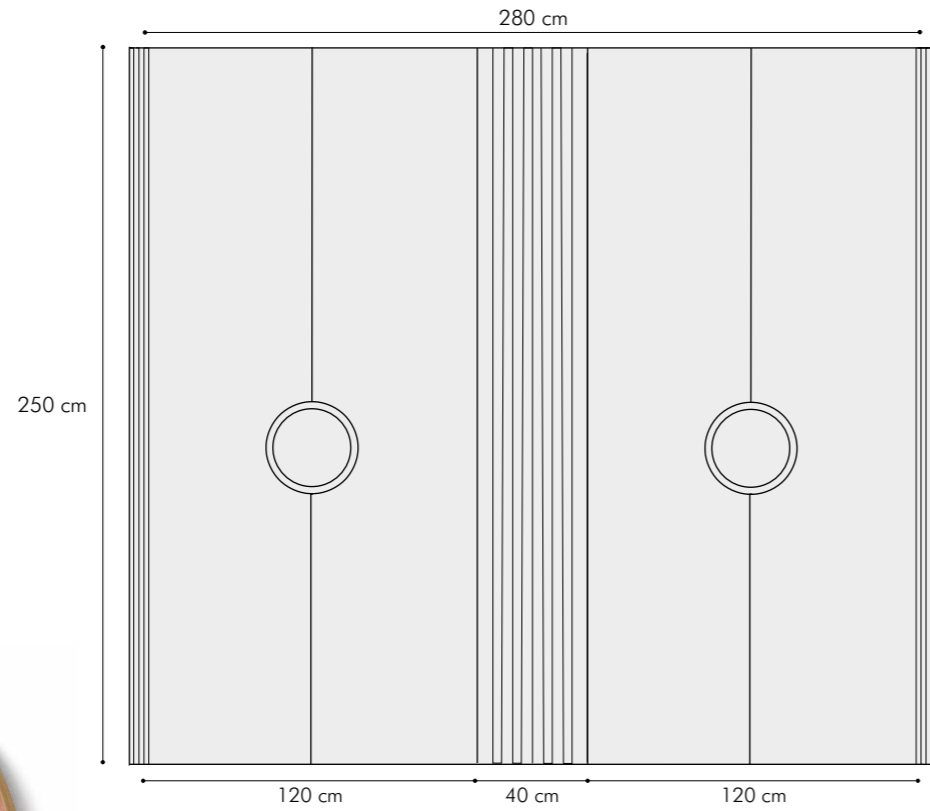
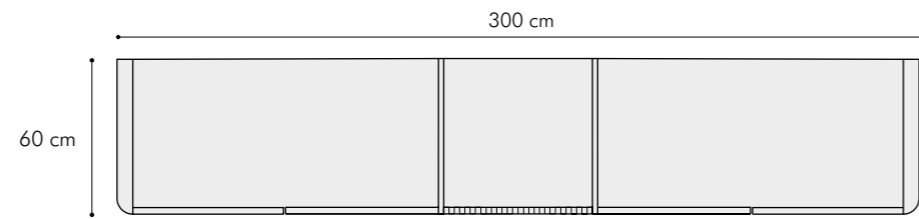

Armadio con ante a battente
Disponibile in tutte le finiture laccato RAL opaco o impiallacciato opaco
Fondini cassetti in ecopelle o laccati
Frontali cassetti in vetro fumé
Illuminazione a LED
Maniglie in finitura OTTONE/TITANIO con inserti in cuoio oppure vetro laccato
Ripiani in vetro fumé
Su richiesta i ripiani possono avere telaio in metallo lucidato OTTONE/TITANIO

Wardrobe
Available in any matt RAL lacquer or matt veneer
Inside bottom of drawers upholstered with eco leather or lacquered
Front of drawers with smoke glasses
LED lights with opening sensor
Handles in BRASS/TITANIUM finish with leather or lacquered glass inserts
Smoke glass shelves
Upon request, glass shelves may have a metal frame BRASS/TITANIUM polished

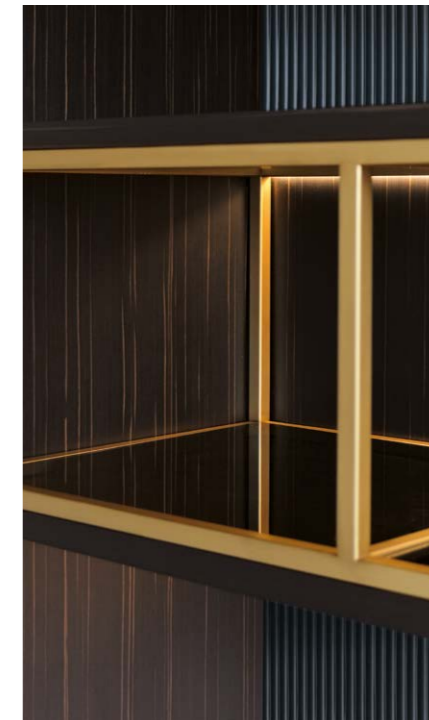
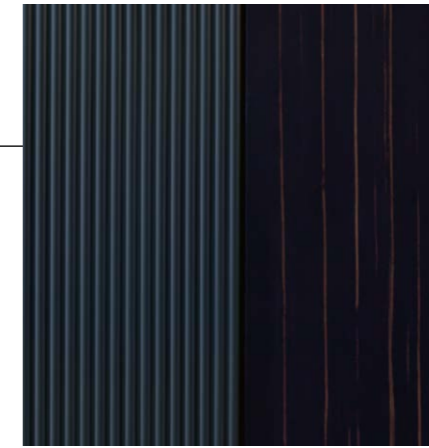
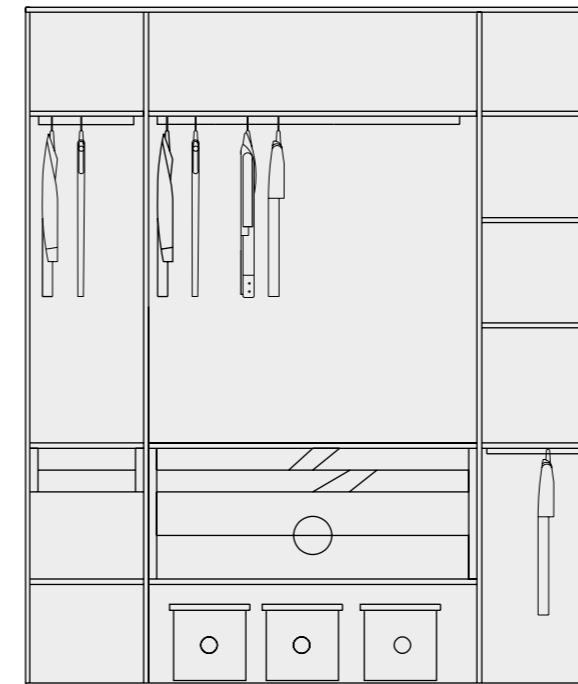
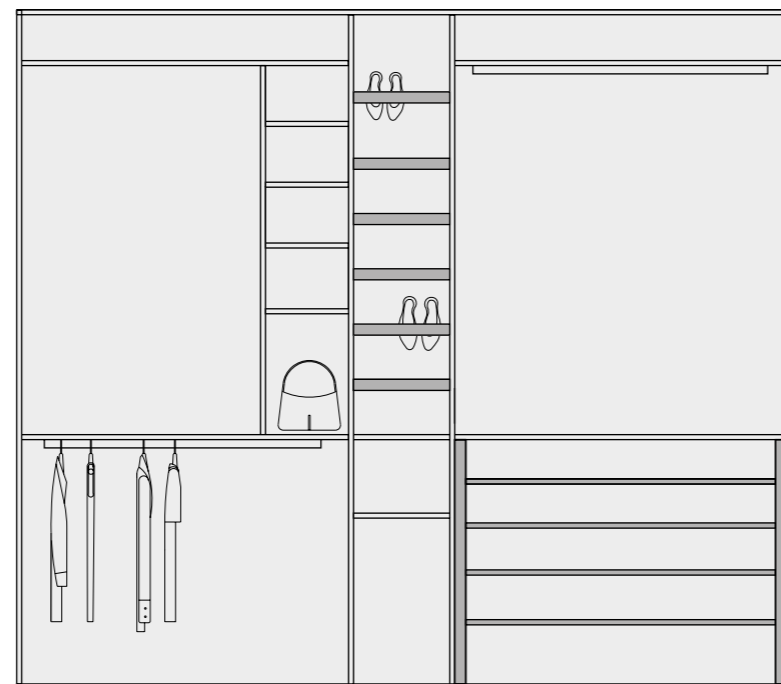

SHORT N09

tavolino
coffee table

MISURE DIMENSIONS
Ø90xH 31 cm

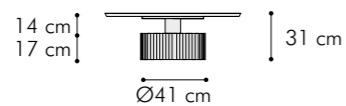

Tavolino
Top Ø cm.90, impiallacciato EBONY, opaco con bisellatura inferiore
Cilindro finitura OTTONE
Base canneté 7026 GRIGIO GRANITO, opaco

Il top è disponibile anche in marmo (N09-M)
o vetro stampato (N09-G)

Coffee table
Top Ø cm.90, EBONY veneered, matt, bevelled edge
BRASS polished cylinder
Base with canneté wooden pattern 7026 GRANITE GREY, matt

Top is also available in marble (N09-M) or printed glass (N09-G)



PAG.14-17, 20-21, 28-30

MID N10-M

tavolino
occasional table

MISURE DIMENSIONS
Ø60xH 43 cm

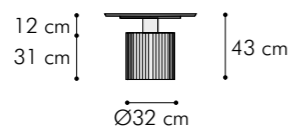

Tavolino
Top Ø cm.60, marmo OCEAN BLACK opaco con bisellatura inferiore
Cilindro finitura OTTONE
Base canneté 7026 GRIGIO GRANITO, opaco

Il top è disponibile anche impiallacciato (N10-W)
o vetro stampato (N10-G)

Occasional table
Top Ø cm.60, OCEAN BLACK marble top, matt, bevelled edge
BRASS polished cylinder
Base with canneté wooden pattern 7026 GRANITE GREY, matt

Top is also available with veneer (N10-W) or printed glass (N10-G)



PAG.14-17, 19-21

MID N10-G

tavolino
occasional table

MISURE DIMENSIONS
Ø60xH 43 cm

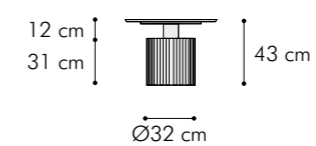

Tavolino
Top Ø cm.60, vetro con stampa digitale BLACK-WOOL
Cilindro finitura OTTONE
Base canneté 7026 GRIGIO GRANITO, opaco

Il top è disponibile anche impiallacciato (N10-W)
o marmo (N10-M)
Vedi pagina 113 per disegni di stampa alternativi

Occasional table
Top Ø cm.60, BLACK-WOOL digital printed glass top
BRASS polished cylinder
Base with canneté wooden pattern 7026 GRANITE GREY, matt

Top is also available with veneer (N10-W) or marble (N10-M)
See page 113 for alternative print patterns



PAG.84-85

UP N12

tavolino
occasional table

MISURE DIMENSIONS
Ø40xH 57 cm

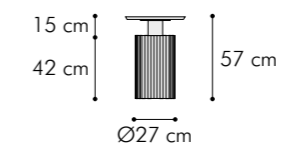

Tavolino
Top Ø cm.40, specchio fumé con bordo finitura OTTONE
Cilindro finitura OTTONE
Base canneté 7026 GRIGIO GRANITO, opaco

Il top è disponibile anche impiallacciato (N12-W),
vetro stampato (N12-G) e marmo (N12-M)

Occasional table
Top Ø cm.40, smoke mirror top, with BRASS polished profile
BRASS polished cylinder
Base with canneté wooden pattern 7026 GRANITE GREY, matt

Top is also available with veneer (N12-W), printed glass (N12-G)
or marble (N12-M)



PAG.14-15, 20-22, 30, 78, 84-85

EASY N23

pouf
pouf

MISURE DIMENSIONS
Ø43xH 46 cm

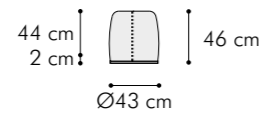

Pouf Ø cm.43
Rivestimento: Nabuk MON-DI 0855, cat. B
Base: metallo finitura OTTONE

Pouf Ø cm.43
Upholstery: Nubuck MON-DI 0855, cat. B
Base: metal BRASS finish



PAG.16, 26-29, 48-50, 54, 58, 66-67, 72-81

COLIBRÌ NL51

lampada da appoggio
table lamp

MISURE DIMENSIONS
14x18x52 cm

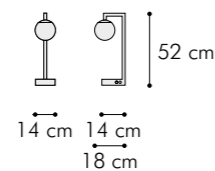

Lampada da appoggio
Metallo finitura OTTONE
Sfera in vetro bianco
Porta USB
Lampadina LED
Accensione con interruttore

Table lamp
Metal BRASS finish
White glass sphere
USB socket
LED bulb
Switch on button



PAG.14-17, 26-27, 74-77

SWAN NL50

lampada da appoggio integrata
built-in table lamp

MISURE DIMENSIONS
14x18x67 cm

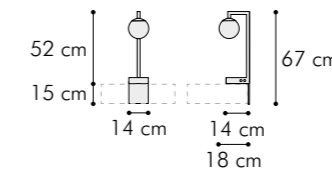

Lampada da appoggio integrata
Metallo finitura OTTONE
Sfera in vetro bianco
Lampadina LED
Accensione touch

Built-in table lamp
Metal BRASS finish
White glass sphere
LED bulb
Touch button



PAG.66-69

FLAMINGO NL52

piantana
floor lamp

MISURE DIMENSIONS
25x25x142 cm

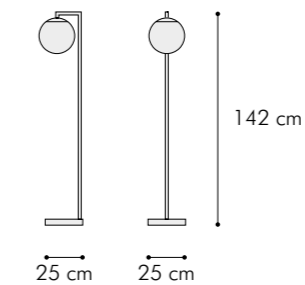

Piantana con base quadrata
Metallo finitura OTTONE
Sfera in vetro bianco
Lampadina LED

Floor lamp with square base
Metal BRASS finish
White glass sphere
LED bulb



PAG.14-16, 20-24, 30, 34, 42-43, 46, 58, 66-68, 72, 74, 76

HERON NL53

piantana
floor lamp



MISURE DIMENSIONS
Ø34,5xH 145 cm

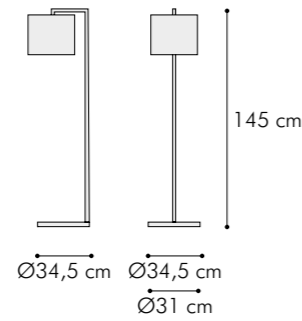

Piantana con base rotonda
Metallo finitura OTTONE
Paralume in tessuto grigio perla
Lampadina LED

Floor lamp with round base
Metal BRASS finish
Pearl grey fabric shade
LED bulb

PAG.18-19, 50, 54, 78-81, 84

SEAGULL NL54

lampadario
chandelier



MISURE DIMENSIONS
Ø60xH 120 cm

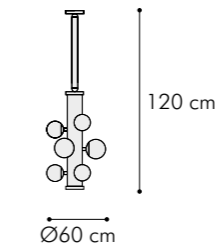

Lampadario con tubolare in metallo
finitura OTTONE
Cintura di sospensione in cuoio
9 sfere in vetro bianco
Lampadine LED

Chandelier with metal BRASS finish tube
Leather suspension belt
9 white glass spheres
LED bulbs

PAG.42-45

NEST NL55

lampadario
chandelier



MISURE DIMENSIONS
Ø38x20 cm

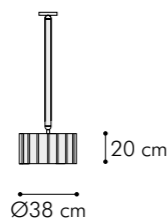

Lampadario con cristalli blu
Cintura di sospensione in cuoio
Lampadina LED

Chandelier with blue crystals
Leather suspension belt
LED bulb

PAG.48-49

EAGLE NL56

lampada da appoggio
table lamp



MISURE DIMENSIONS
Ø30x35 cm

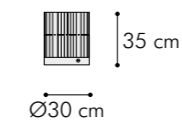

Lampada da appoggio con cristalli blu
Base in cuoio con presa USB
Lampadina LED

Table lamp with blue crystals
Leather base with USB socket
LED bulb

PAG.28-30, 48-50, 54, 57

TREASURE NA40

scatola
box

MISURE DIMENSIONS
25X25xH 13 cm

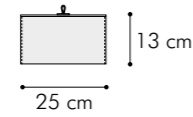

Scatola con coperchio
Cuoio COGNAC

Box with lid
Leather COGNAC



PAG.74

SOFT 30 NA42

cuscinò
cushion

MISURE DIMENSIONS
50x30 cm

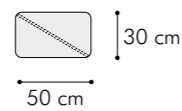

Cuscino
Rivestimento: pelle DAK-DI 0229, cat. A,
con impuntura a due aghi

Cushion
DAK-DI 0229, cat.A, with two-needle stitching



PAG.14-19, 76

SOFT 65 NA41

cuscinò
cushion

MISURE DIMENSIONS
65x65 cm

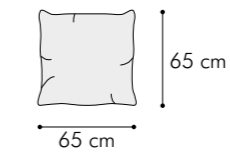

Cuscino
Rivestimento: CIR-AL 03, cat. 3

Cushion
Covering: CIR-AL 03, cat. 3



PAG.18-20

SOFT 50 NA43

cuscinò
cushion

MISURE DIMENSIONS
50x50 cm

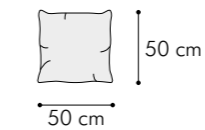

Cuscino
Rivestimento: GAR-AL 04, cat. 2

Cushion
Covering: GAR-AL 04, cat. 2



PAG.18-20, 74

TESSUTI E FINITURE
FABRICS AND FINISHES

PELLE . LEATHER cat.A



DAK-DI 0229

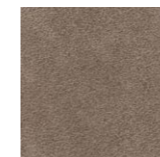

DAK-DI 0311

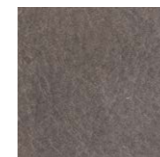

DAK-DI 0855

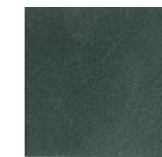

DAK-DI 0681

NABUK . NUBUCK cat.B



MON-DI 0855



MON-DI 06048

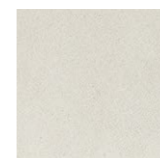

MON-DI 0854

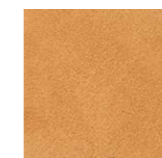

MON-DI 03403

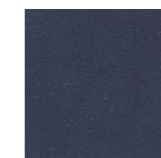

MON-DI 07120

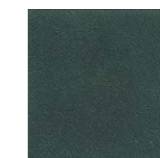

MON-DI 06099

TESSUTI . FABRICS

AZI-GL cat.1



AZI-GL 803



AZI-GL 102 AZI-GL 910 AZI-GL 303 AZI-GL 905 AZI-GL 904 AZI-GL 501 AZI-GL 606

MIN-AL cat. 2



MIN-AL 06

GAR-AL cat.2



GAR-AL 07 GAR-AL 03 GAR-AL 04

BAR-MR-GL cat.2



BAR-MR-GL 501 BAR-MR-GL 502

CIR-AL cat.3

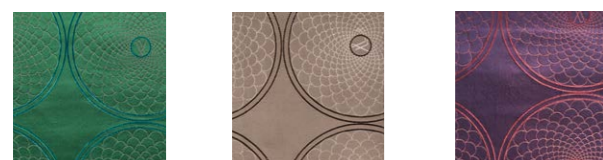

CIR-AL 03 CIR-AL 09 CIR-AL 04

KAT-AL cat. 2



KAT-AL 01 KAT-AL 09 KAT-AL 05

BAR-GL cat. 2



BAR-GL 01 BAR-GL 04 BAR-GL 08

TAD-GL cat. 2



TAD-GL 13 TAD-GL 16 TAD-GL 12 TAD-GL 01

RUSH-GL cat. 1



RUSH-GL 401/A RUSH-GL 401/B RUSH-GL 407/A RUSH-GL 406/A

BAN-GL cat. 2

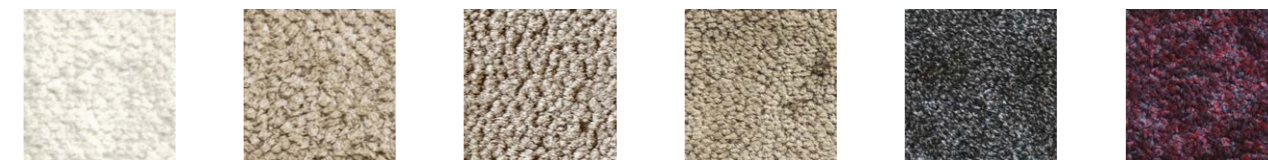

BAN-GL 24 BAN-GL 01 BAN-GL 02 BAN-GL 08 BAN-GL 05 BAN-GL 25

PIP-GL cat. 1



PIP-GL 24

ECOPELLE - ECO-LEATHER*



TAN 320 CREAM 007

* Per interno cassetti/schienali
For inside bottom of drawers/back panels

MANIGLIE . HANDLES Ø20 cm - Ø12 cm

CUOIO . LEATHER



COGNAC



HONEY

DARK

VETRO LACCATO . LACQUERED GLASS

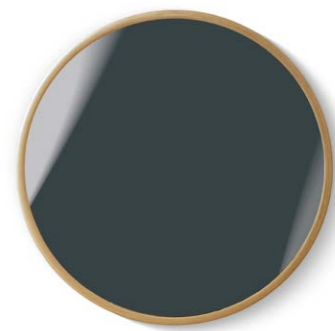

7026 GRANITE GREY



6005 MOSS GREEN

5020 OCEAN BLUE

5004 BLACK BLUE

7010 TARPAULIN GREY

7038 AGATE GREY

1019 GREY BEIGE

1013 OYSTER WHITE

8025 PALE BROWN

8004 COPPER BROWN

8003 CLAY BROWN

1005 HONEY YELLOW

VETRO STAMPA DIGITALE . HIGH DEFINITION DIGITAL PRINTED GLASS

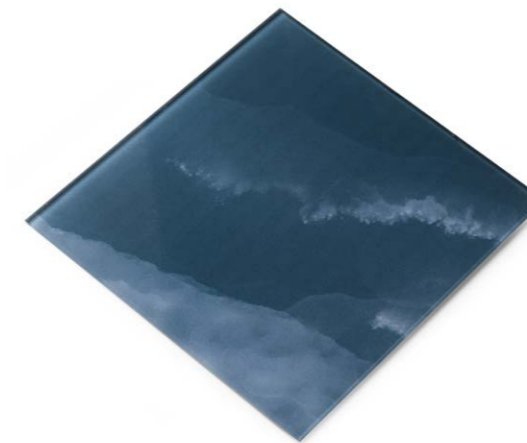

BLUE-SKY



STORM

CLOUD

BLACK-WOOL

BLUE-WOOL

RED-WOOL

GREY-LINEN

BEIGE-LINEN

MARMI . MARBLES*



OROBIC RED-MATT



WHITE CALACATTA

WHITE CARRARA

OMBRA DI CARAVAGGIO

OROBIC GREY

OCEAN BLACK-MATT

* Disponibili in finitura lucida e opaca
Available in glossy and matt finish

LACCATI . LACQUERED*



7026 GRANITE GREY



6005
MOSS GREEN



5020
OCEAN BLUE



5004
BLACK BLUE



7010
TARPAULIN GREY



7038
AGATE GREY



1019
GREY BEIGE



1013
OYSTER WHITE



8025
PALE BROWN



8004
COPPER BROWN



8003
CLAY BROWN



1005
HONEY YELLOW

* Disponibili in finitura lucida e opaca
Available in glossy and matt finish

METALLI . METALS



OTTONE
BRASS



TITANIO
TITANIUM

ESSENZE . WOOD VENEER



EBONY-MATT



ZINGANA

^{IT} Scappini & C srl si riserva in qualsiasi momento la facoltà di apportare tutte le modifiche necessarie al miglioramento funzionale e qualitativo dei propri prodotti. Per ogni aspetto tecnico e dimensionale fare riferimento ai listini aziendali e relativi aggiornamenti. I colori e i materiali riprodotti nelle immagini stampate hanno un valore indicativo. Scappini & C srl declina ogni responsabilità derivante da eventuali inesattezze di stampa e/o da errori sulle caratteristiche dei prodotti forniti.

^{EN} In line with its policy of improving product function and quality, Scappini & C srl reserves the right to make any necessary changes at any time. For information of a technical and dimensional nature, refer to the company price lists and relevant updates. The colours and materials reproduced in the images printed herein are given as an approximate guide only. Scappini & C srl does not accept any responsibility for misprints and/or mistakes in describing the characteristics of the products supplied.

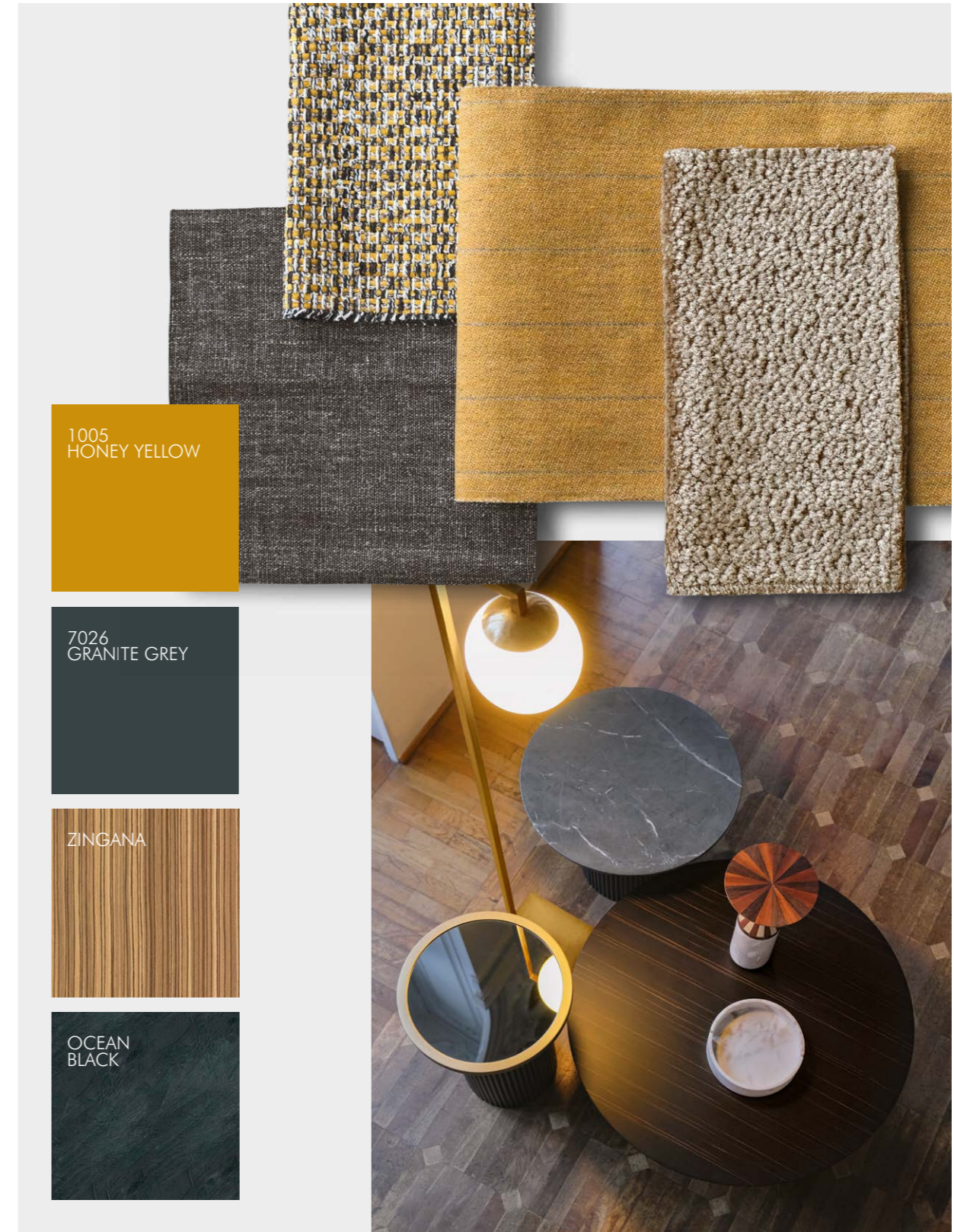
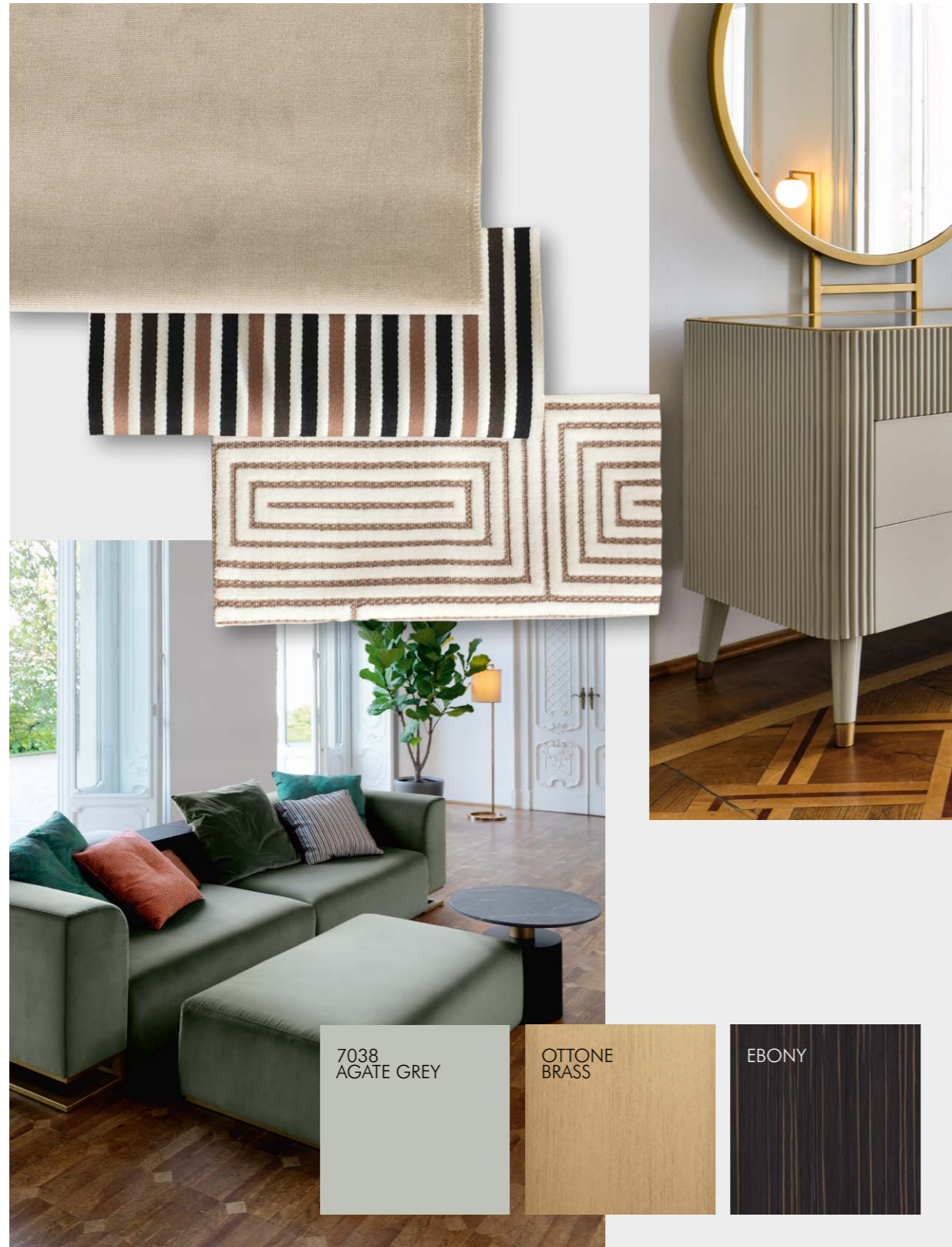

QUESTO CATALOGO È IL FRUTTO DELLA SINERGIA DI TUTTE LE PERSONE CHE SI VEDONO QUI A FIANCO. OGNUNA DI LORO, PER LA PROPRIA COMPETENZA, HA MESSO AL SERVIZIO DEL RISULTATO FINALE IL SUO IMPEGNO, LA SUA PASSIONE E LA SUA PROFESSIONALITÀ. LA LOCATION PRESTIGIOSA E STRAORDINARIA HA CONTRIBUITO A RENDERE IL LAVORO STIMOLANTE E GRATIFICANTE.

THIS CATALOGUE IS THE RESULT OF THE SINERGY OF ALL THE PEOPLE ON THE SIDE PICTURE. EACH ONE OF THEM WITH HIS OWN COMPETENCE, WITH PASSION AND PROFESSIONALISM, GAVE A PRECIOUS CONTRIBUTE FOR THE ACHIEVEMENT OF THIS PROJECT. THE AMAZING AND PRESTIGIOUS LOCATION CONTRIBUTED TO MAKE A CHALLENGING AND REWARDING JOB.



ITALIER



www.italier.cz | info@italier.cz | +420 774 431 196