

**QUADRO FILO**

*Collezione / Collection*

**ITALIER**



# QUADRO FILO

Collezione / Collection

## SEZIONE Frontale

Front SECTION

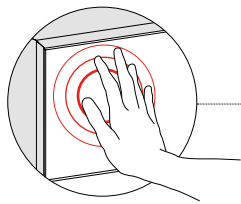
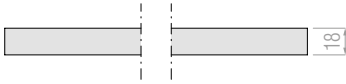

apertura tramite push & pull  
opening by push & pull

piedino regolabile h.15 di serie  
 standard h.15 levelling feet

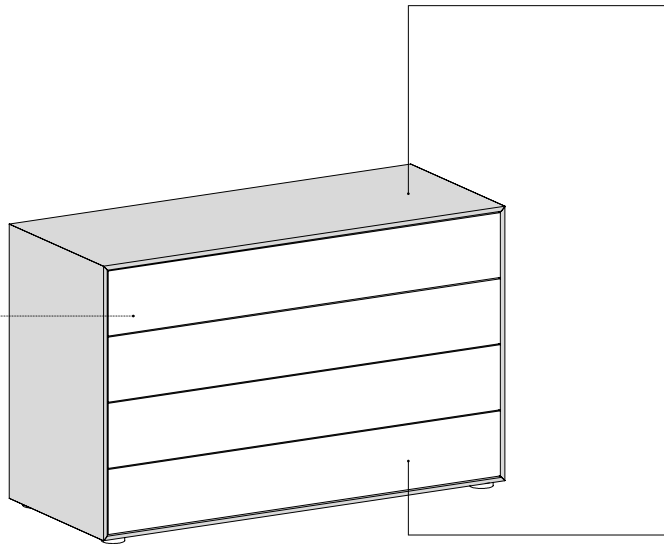

## Finiture SCOCCA

BODY Finishes

ES / essenza  
CE / colore eco  
LO / laccato opaco  
LL / laccato lucido

## Finiture FRONTALI

FRONTS Finishes

ES / essenza  
CE / colore eco  
LO / laccato opaco  
LL / laccato lucido  
MT / concrete

- \_ Le scocche dei moduli sono in folding, pannelli giuntati a 45°.
- \_ Il settimanale e il comò sono dotati di kit anti-ribaltamento.
- \_ **NON SI ESEGUONO LAVORAZIONI SU MISURA.**

- \_ The body of the modules are in folding wooden, joined at 45° panels.
- \_ The chest and dresser have anti-tip kit.
- \_ **CUSTOMIZATION NOT POSSIBLE.**

## Comodino 2 cassetti

2-drawer Bedside Table

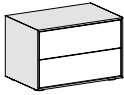

L: 613 H: 404 P: 400  
W: W: H: H: D: D:

## Comodino 3 cassetti

3-drawer Bedside Table

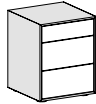

L: 400 H: 511 P: 400  
W: W: H: H: D: D:

## Comodino 3 cassetti

3-drawer Bedside Table

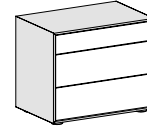

L: 613 H: 511 P: 400  
W: W: H: H: D: D:

## Comò 4 cassetti

4-drawer Dresser

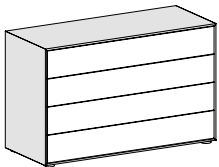

L: 1226 H: 766 P: 500  
W: W: H: H: D: D:

## Settimanale 7 cassetti

Chest of 7 drawers

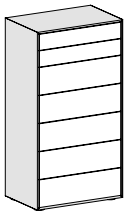

L: 613 H: 1161 P: 400  
W: W: H: H: D: D:

## Faretto Illumina Cassetto

*Drawer Spotlight*

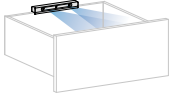

## Lampada Snodabile con 2 porte USB

*Adjustable Lamp with 2 USB ports*

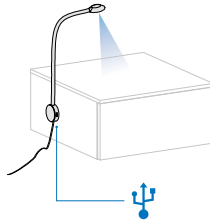

## Guide ad estrazione totale per cassetto

*Full-extension Runners*

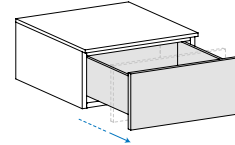

# ITALIER



[www.italier.cz](http://www.italier.cz) | [info@italier.cz](mailto:info@italier.cz) | +420 774 431 196