

**DICIOTTO**

*Sistemi Componibili / Modular Ranges*

# ITALIER



## SEZIONE Frontale

Front SECTION

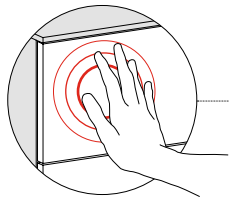
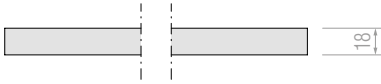

apertura tramite push & pull (di serie)  
opening by push & pull (standard)

piedino regolabile h.23 di serie  
standard h.23 levelling feet

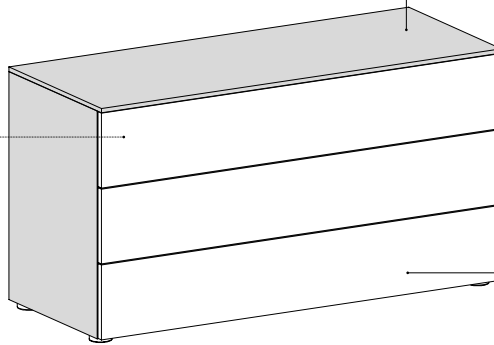

## Finiture SCOCCA

BODY Finishes

ES / essenza  
EH / essenza light  
CE / colore eco  
LO / laccato opaco  
LL / laccato lucido

## Finiture FRONTALI

FRONTS Finishes

ES / essenza  
EH / essenza light  
IM / impiallacciato  
CE / colore eco  
LO / laccato opaco  
LL / laccato lucido  
SC / essenza scult  
SL / laccato opaco scult  
MT / concrete  
TR / trama

- \_ I moduli sono dotati di top Sp.12 della stessa finitura della scocca.
- \_ I cassetti, se provvisti di maniglia, sono dotati di rallentatori.
- \_ In alternativa ai piedini regolatori di serie, i moduli possono essere dotati di zoccolatura H.23 o staffe.
- \_ Se appesi o se sovrapposti ad altri, i moduli devono essere obbligatoriamente dotati di attaccaglie per fissaggio a muro.
- \_ **NON SI ESEGUONO LAVORAZIONI SU MISURA.**

- \_ The modules are equipped with Thk.12 top in the same finish as the body.
- \_ If equipped with handles the drawers are equipped with soft closing runners.
- \_ As alternative to standard levelling feet, the modules can be equipped by H.23 plinth or brackets.
- \_ If the modules are hung or superimposed on others must be mandatorily equipped with the bracket kit for wall-mounting kit.
- \_ CUSTOMIZATION NOT POSSIBLE.

**Larghezza**  
Width

460

613

766

919

1225

1378

1531

**Altezza**  
Height

243 (220+23)



451 (428+23)

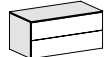

659 (636+23)

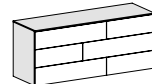
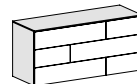
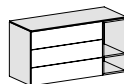
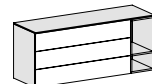
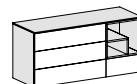
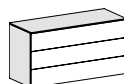
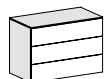

867 (844+23)

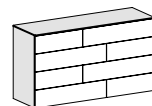
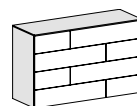

1283 (1260+23)

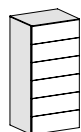

**Maniglia MNG 240**  
Handle MNG 240

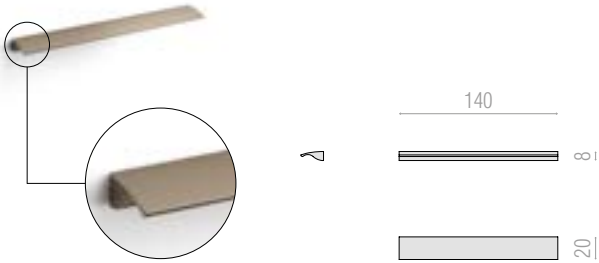

**Maniglia MNG 285**  
Handle MNG 285

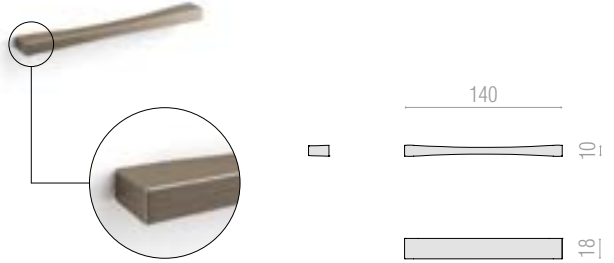

**Maniglia MNG 532**  
Handle MNG 532

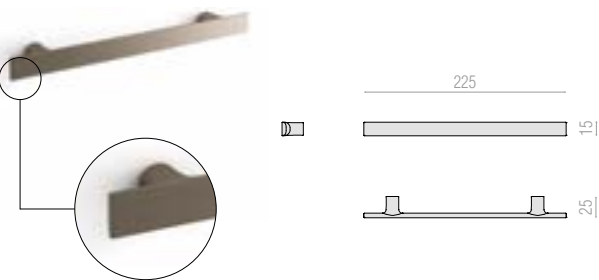

**Maniglia MNG 533**  
Handle MNG 533

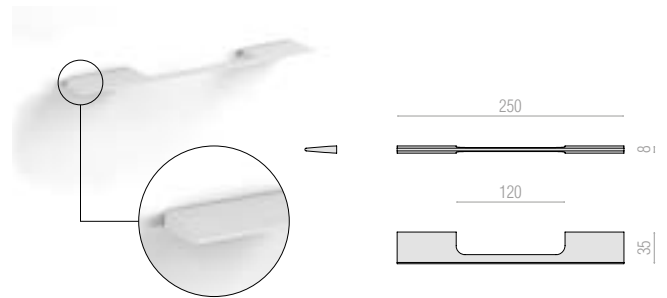

## Basamenti disponibili

Plinthes available

### Piedino H.23 (di serie)

H.23 Feet (standard)



### Basamento Plexi

Plexi Plinth



### Basamento Corner

Corner Plinth



Largh. (mm): 460, 613, 766, 919, 1225, 1378, 1531  
Widht (mm):

Largh. (mm): 460, 613, 766, 919, 1225, 1378, 1531  
Widht (mm):

## Accessori

Accessories

### Faretto Illumina Cassetto

Drawer Spotlight

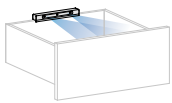

### Lampada Snodabile con 2 porte USB

Adjustable Lamp with 2 USB ports

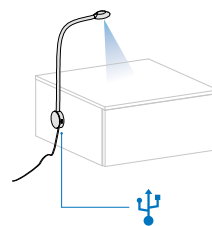

### Guide ad estrazione totale per cassetto

Full-extension Runners

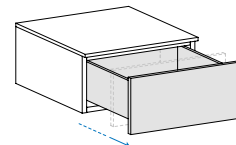

### Portariviste Vetro L.153 (Vetro Stopsol)

Glass Magazine Rack W.153 (Stopsol Glass)

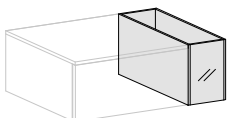

Il Portariviste può essere posizionato a Sinistra o a Destra del modulo.

The Glass Magazine Rack can be positioned on the left or right of the module.

# ITALIER



[www.italier.cz](http://www.italier.cz) | [info@italier.cz](mailto:info@italier.cz) | +420 774 431 196