

EGO

Sistemi Componibili / Modular Ranges

ITALIER



SEZIONE Frontale

Front SECTION

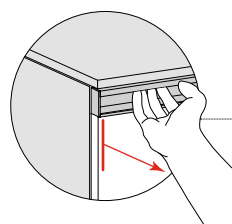
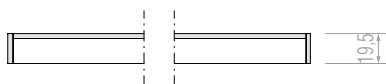

apertura tramite presa gola
opening by groove profile grip

piedino regolabile h.23 di serie
standard h.23 levelling feet

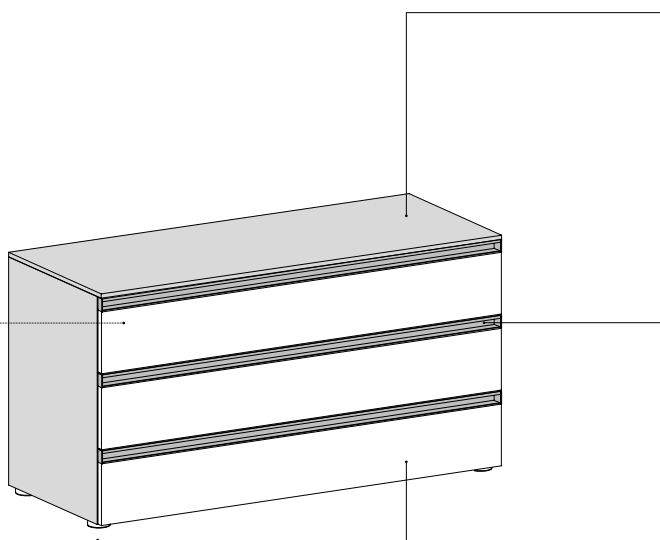

Finiture SCOCCA

BODY Finishes

ES / essenza
EH / essenza light
CE / colore eco
LO / laccato opaco
LL / laccato lucido

Finiture PROFILO GOLA

GROOVE PROFILE Finishes

LO / laccato opaco
VM / vernici metalliche















Finiture FRONTALI

FRONTS Finishes

ES / essenza
EH / essenza light
CE / colore eco
LO / laccato opaco
LL / laccato lucido
IM / legno impiallacciato
MT / concrete
TR / trama

- _ I moduli sono dotati di top Sp.12 della stessa finitura della scocca.
- _ I moduli sono dotati di guide scorrevoli rallentate.
- _ In alternativa ai piedini regolatori di serie, i moduli possono essere dotati di zoccolatura H.23 o staffe. Vedi pag. 56.
- _ Se appesi o se sovrapposti ad altri, i moduli devono essere obbligatoriamente dotati di attaccaglie per fissaggio a muro.
- _ **NON SI ESEGUONO LAVORAZIONI SU MISURA.**

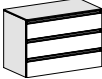
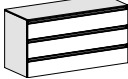
- _ The modules are equipped with Thk.12 top in the same finish as the body.
- _ The drawers are equipped with soft-closing runners.
- _ As alternative to standard levelling feet, the modules can be equipped by H.23 plinth or brackets. See page 56.
- _ If the modules are hung or superimposed on others must be mandatorily equipped with the bracket kit for wall-mounting kit.
- _ **CUSTOMIZATION NOT POSSIBLE.**

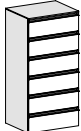
	460	613	766	919	1225	1531
Larghezza <i>Width</i>						
Altezza <i>Height</i>						
<u>243 (220+23)</u>		 		 		
<u>451 (428+23)</u>		 				
<u>659 (636+23)</u>					 	
<u>1283 (1260+23)</u>						

Basamenti disponibili

Plinthes available

Piedino H.23 (di serie)

H.23 Feet (standard)



Basamento Plexi

Plexi Plinth



Basamento Corner

Corner Plinth



Largh. (mm): 460, 613, 766, 919, 1225, 1378, 1531
 Widht (mm):

Largh. (mm): 460, 613, 766, 919, 1225, 1378, 1531
 Widht (mm):

Accessori

Accessories

Faretto Illumina Cassetto

Drawer Spotlight

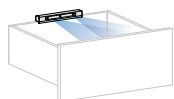

Lampada Snodabile con 2 porte USB

Adjustable Lamp with 2 USB ports

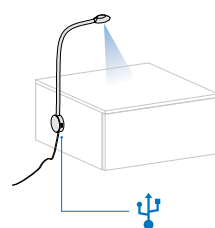

Guide ad estrazione totale per cassetto

Full-extension Runners

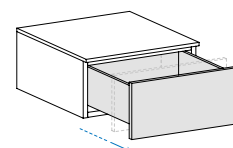

Portariviste Vetro L.153 (Vetro Stopsol)

Glass Magazine Rack W.153 (Stopsol Glass)

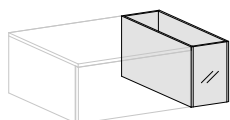

Il Portariviste può essere posizionato a Sinistra o a Destra del modulo.

The Glass Magazine Rack can be positioned on the left or right of the module.

ITALIER



www.italier.cz | info@italier.cz | +420 774 431 196