



POSH
collection



ITALIER

POSH collection

la bellezza è proporzione



PLUS:
sistema con
schienali reclinabili
system with
reclining backrests

POSH

Tre differenti interpretazioni, di base e bracciolo, sono il risultato estetico di proporzione ed equilibrio. Lo schienale reclinabile è il punto d'incontro tra comodità e funzione.

Three different interpretations of sofa bases and armrests are the aesthetic result of proportion and balance. The reclining backrest is the meeting point between comfort and function.



POSH line pag. 05

Informazioni tecniche pag. 42

Il comfort si esprime attraverso un design essenziale

Comfort is expressed through a simple and essential design



POSH lift pag. 21

Informazioni tecniche pag. 44

Percorsi tra comodità ed estetica razionale

Journeys for the discovery of comfort and rational aesthetics

POSH bold pag. 31

Informazioni tecniche pag. 46

Personalità spiccata di forme e profili

A strong personality of forms and shapes

POSH | l i n e

Lo stile minimalista regala un approccio estetico elegante ed esclusivo dove le idee compositive sembrano sospese per la loro leggerezza strutturale.

The minimalist style offers an exclusive and elegant aesthetic approach, where compositional ideas appear to be suspended by virtue of their structural lightness.

POSH line

Divano laterale cm 188 dx e
panchetta sx. Tre cuscini cm 55x30 e
un cuscino cm 40x40.

*188 cm right sided sofa and
left sided bench. Three 55x30 cm
cushions and one 40x40 cm cushion.*



POSH line slim

Divano cm 216 con bracciolo SLIM.
Piede Blade cromo.
Due cuscini cm 40x40 e un cuscino
cm 40x40 con finitura Line.

216 cm sofa with SLIM armrests.
Blade feet in chrome.

Two 40x40 cm cushions and one
40x40 cm cushion in Line finish.





Le forme si intersecano con estrema naturalezza dando origine ad un dinamismo compositivo comunque ancorato a concetti di rigore e funzionalità.

The shapes come together in an exceptionally natural way, bringing to life a compositional dynamism still anchored in the concepts of rigour and functionality.



POSH line slim

Il cuscino sagomato della seduta diventa il dettaglio perfetto per descrivere il concetto di proporzione ed armonia.

The contoured seat cushion becomes the perfect detail for describing the concept of proportion and harmony.



POSH line

Divano cm 232.
Piede Blade manganese.
Due cuscini cm 40x40.

232 cm sofa.
Blade feet in manganese.
Two 40 x 40 cm cushions.





POSH line slim

Divano laterale cm 180 dx con bracciolo SLIM e penisola angolare con pouff sx. Pouff. Piede Blade cromo. Un cuscino cm 40x40, un cuscino cm 40x40 con finitura Line e un cuscino cm 55x30 con finiture Line.

180 cm right sided sofa with SLIM armrests and left sided corner chaise with pouf. Pouf. Blade feet in chrome. One 40x40 cm cushion, one 40x40 cm cushion in Line finish and one 55x30 cm cushion in Line finish.



Un profilo sottile sostiene e descrive con stile l'intera composizione evidenziando una personalità audace dal carattere contemporaneo.

A slim profile supports and describes the entire composition with great style, emphasising a bold personality of a contemporary character.



POSH line slim

Divano cm 196 con bracciolo SLIM.
Piede Tip manganese.
Tre cuscini cm 40x40.

196 cm sofa with SLIM armrests.
Tip feet in manganese.
Three 40x40 cm cushions.

POSH | l i f e

La base e il bracciolo si coordinano delimitando la nuova area del comfort.
La razionalità progettuale si integra allo spazio ed a qualsiasi tipologia di mood e stile di vita.

*The coordinated base and armrest define the new concept of comfort.
The rational design integrates into the space and complements any type of mood and lifestyle.*

POSH lift

Divano cm 238.
Piede Logic manganese.
Due cuscini cm 55x30 e
un cuscino cm 40x40.

238 cm sofa.
Logic feet in manganese.
Two 55x30 cm cushions and
one 40x40 cm cushion.





POSH lift

Divano laterale cm 176 sx e penisola
angolare con Even colore nero dx.
Tre cuscini cm 40x40 e
un cuscino cm 55x30.

*176 cm left sided sofa and 225 cm
right sided corner chaise with Even
accessory in black. Three 40x40 cm
cushions and one 55x30 cm cushion.*



Componibilità e ampia disponibilità di accessori: l'isola del relax cambia, si evolve, diventando espressione delle esigenze del quotidiano ed interpretazione perfetta di praticità e flessibilità.

Modularity and a wide selection of accessories: the refuge of comfort changes, evolves and becomes an expression of everyday needs and a perfect interpretation of practicality and flexibility.





POSH lift

Divano laterale cm 176 sx e
panchetta dx.
Piede Tip manganese.
Tre cuscini cm 55x30 e
un cuscino cm 40x40.

*176 cm left sided sofa and right sided
bench. Tip feet in manganese.
Three 55x30 cm cushions and
one 40x40 cm cushion.*

POSH

b o l d

La sobrietà e l'intelligenza di un design che trascende tempi e mode, fatto di sostanza e di geometria impeccabile. Una personalità forte, risoluta, dalla natura progettuale semplice ed efficace.

The simplicity and intelligence of a design that transcends time and trends, made of substance and impeccable geometry. A strong and determined personality, characterised by a simple and effective design.



POSH bold

Divano cm 226. Pouff cm 82x52.
Piede Edge. Tre cuscini cm 40x40 e
un cuscino cm 55x30.

226 cm sofa. 82 x 52 cm pouf.
Edge feet. Three 40 x 40 cm cushions
and one 55 x 30 cm cushion.



POSH bold

Divano laterale cm 186 sx e
panchetta dx. Piede Edge.
Tre cuscini cm 55x30 e
due cuscini cm 40x40.

*186 cm left sided sofa and right sided
bench. Edge feet. Three 55x30 cm
cushions and two 40x40 cm cushions.*



POSH bold

Prospettive che evidenziano un contrasto tra le linee compositive. Ne deriva una perfetta integrazione, coordinata ed armonica nella sua totalità estetica.

Perspectives that emphasise a contrast between the compositional lines. The result is a seamless integration, coordinated and harmonious in its aesthetic entirety.



Con semplicità gli schienali possono assumere posizioni diverse riscrivendo, senza equivoci, un nuovo concetto di comodità estremamente su misura.

The backs can effortlessly assume different positions, unequivocally redefining a new concept of exceptionally customisable comfort.



POSH bold

Divano laterale cm 186 dx e penisola
angolare con pouff sx. Piede Steel.
Due cuscini cm 40x40 e
due cuscini cm 55x30.

186 cm right sided sofa and left sided
corner chaise with pouf. Steel feet.
Two 40x40 cm cushions and
two 55x30 cm cushions.



Sistema con schienali reclinabili
System with reclining backrests

POSH

l i n e
l i f t
b o l d

Informazioni Tecniche
Technical Sheet

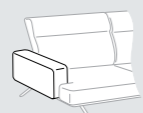

Bracciolo di serie
L 24

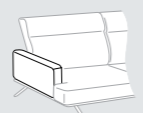

Bracciolo SLIM
L 16

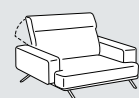

Poltrona
L 130 P 98/130 H 93
SLIM L 114 P 98/130 H 93

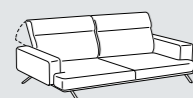

Divano
L 192 P 98/130 H 93
SLIM L 176 P 98/130 H 93

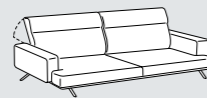

Divano
L 212 P 98/130 H 93
SLIM L 196 P 98/130 H 93



Divano
L 232 P 98/130 H 93
SLIM L 216 P 98/130 H 93

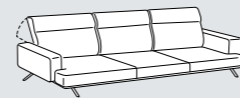

Divano
L 264 P 98/130 H 93
SLIM L 248 P 98/130 H 93



Poltrona
laterale dx/sx
L 106 P 98/130 H 93
SLIM L 98 P 98/130 H 93

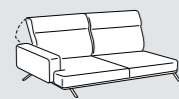

Divano
laterale dx/sx
L 168 P 98/130 H 93
SLIM L 160 P 98/130 H 93



Divano
laterale dx/sx
L 188 P 98/130 H 93
SLIM L 180 P 98/130 H 93

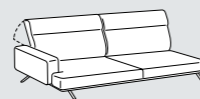

Divano
laterale dx/sx
L 208 P 98/130 H 93
SLIM L 200 P 98/130 H 93



Panchetta dx/sx
L 106 P 153/185 H 93
SLIM L 98 P 153/185 H 93



Penisola angolare
c/pouff dx/sx
L 98/130 P 230 H 93

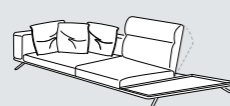

Penisola angolare
c/Even dx/sx
L 98/130 P 225 H 93



Pouff
L 98 P 68 H 42



Cuscino
L 40 x 40



Cuscino
L 50 x 50



Cuscino
L 55 x 30

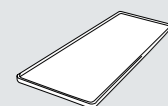

Accessorio Even
43x93



Finitura nera di serie.
Standard black finishes.

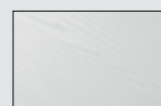

Finitura bianca optional.
Optional white finishes.



Finitura beige optional.
Optional beige finishes.



Piede Tip finitura cromo di serie, finitura manganese optional.

Tip feet in chrome finish as standard, manganese finish optional.



Piede Blade finitura cromo o manganese optional.

Blade feet in chrome finish or in optional manganese finish.

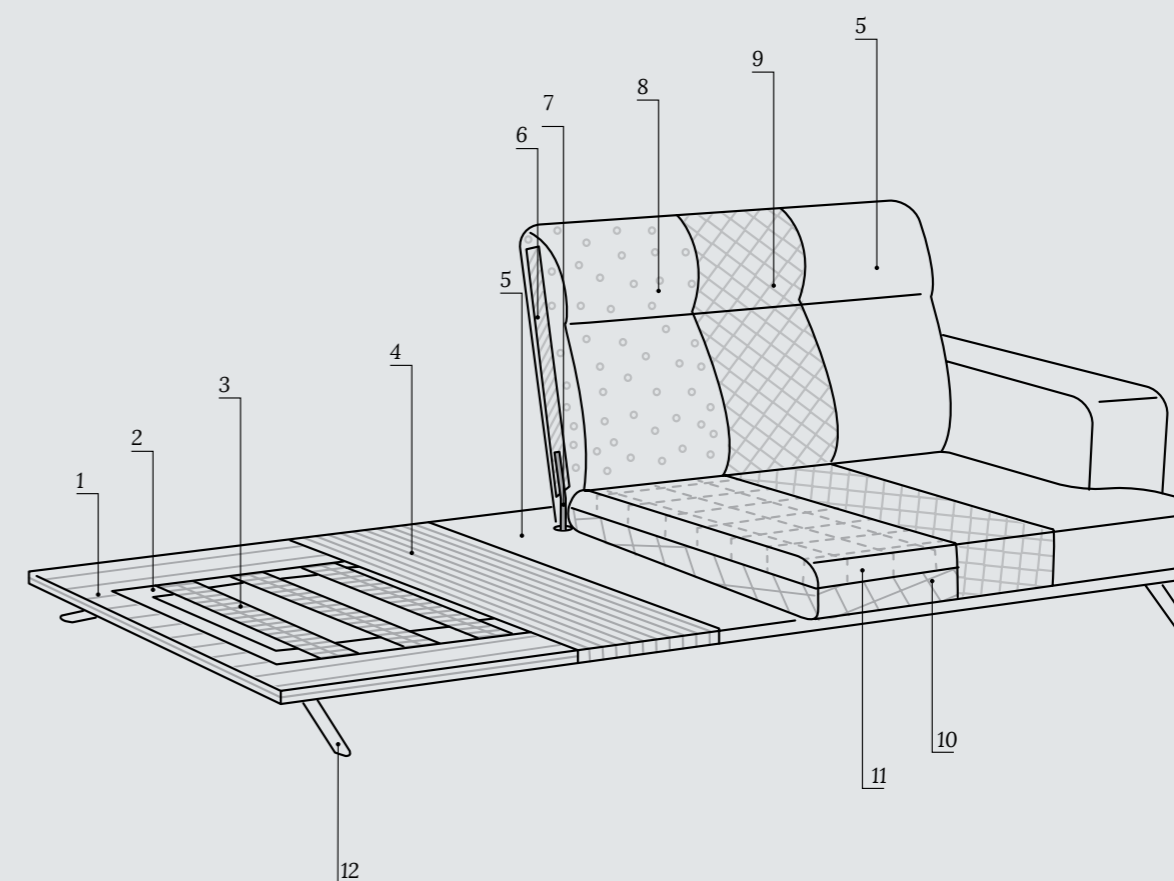

Legenda

- Struttura in legno stagionato.
Structure in seasoned wood.
- Telaio in acciaio verniciato.
Painted steel frame.
- Molle sedute nastri elastici in fibra propilenica e lattice da 80 mm tesi meccanicamente.
Seat springing with elastic straps in propylene fibre and mechanically stretched 80 mm lattice.
- Vellutino accoppiato in fibra di poliestere gr. 300.
Velveteen bonded to 300 g polyester fibre.
- Rivestimento completamente sfoderabile in tessuto, parzialmente sfoderabile in pelle o ecopelle.
Fully removable upholstery in fabric, partially removable in leather or faux leather.
- Inserto in multistrato.
Multi-layer insert.
- Meccanismo schienale reclinabile in acciaio.
Reclining backrest mechanism in steel.
- Cuscino schienale in poliuretano espanso indeformabile D18.
Back cushion in D18 non-deformable polyurethane foam.
- Rivestimento in ovatta di poliestere gr. 500.
Lining in 500 g polyester wadding.
- Cuscino seduta in poliuretano espanso indeformabile D35.
Seat cushion in D35 non-deformable polyurethane foam.
- Bombatura seduta in poliuretano espanso indeformabile D28.
Top of seat in D28 non-deformable polyurethane foam.
- Piede Tip di serie, Blade optional.
Tip feet as standard, Blade feet optional.

Schienali reclinabili in molteplici posizioni / Reclining backrests with multiple positions



A seconda della collocazione del divano si potranno gestire le diverse inclinazioni dello schienale. Tenendo il divano appoggiato alla parete si potranno sfruttare le posizioni dello schienale per i primi 20° mantenendo così un ingombro totale di cm 98. Inclinando ulteriormente lo schienale oltre i 20°, aumenta di conseguenza la profondità del divano fino ad un massimo di cm 130 con un' inclinazione di 60°.

Depending on the location of the sofa, different backrest positions are possible. If the sofa is positioned against a wall, backrest positions corresponding to the first 20° can be set, thus maintaining a total footprint of 98 cm. Inclining the backrest by more than 20° consequently increases the depth of the sofa, up to a maximum of 130 cm with a 60° inclination angle.

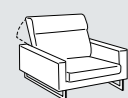

Poltrona
L 104 P 98/130 H 93

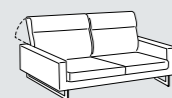

Divano
L 166 P 98/130 H 93

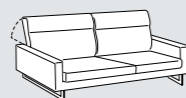

Divano
L 186 P 98/130 H 93

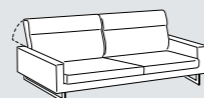

Divano
L 206 P 98/130 H 93

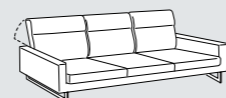

Divano
L 238 P 98/130 H 93



Poltrona
laterale dx/sx
L 94 P 98/130 H 93

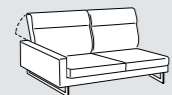

Divano
laterale dx/sx
L 156 P 98/130 H 93

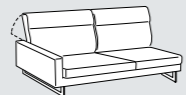

Divano
laterale dx/sx
L 176 P 98/130 H 93

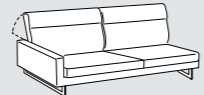

Divano
laterale dx/sx
L 196 P 98/130 H 93

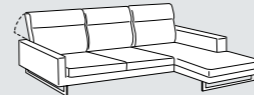

Componibile
panchetta dx/sx
L 238 P 153/185 H 93

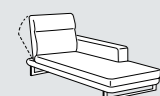

Panchetta dx/sx
L 94 P 153/185 H 93



Penisola angolare
c/pouff dx
L 98/130 P 230 H 93

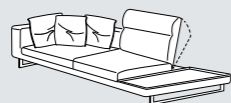

Penisola angolare
c/Even dx/sx
L 98/130 P 225 H 93



Pouff
L 72 P 52 H 42
L 82 P 52 H 42
L 92 P 52 H 42



Cuscino
L 40 x 40



Cuscino
L 50 x 50



Cuscino
L 55 x 30

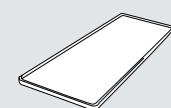

Accessorio Even
43 x 93



Finitura nera di
serie.
Standard black
finishes.

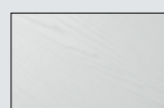

Finitura bianca
optional.
Optional white
finishes.



Finitura beige
optional.
Optional beige
finishes.



Piede Logic finitura
cromo di serie, finitura
manganese optional.

Logic feet in chrome
finish as **standard**,
manganese finish
optional.



Piede Tip finitura cromo o
manganese optional.

Tip feet in chrome finish or in
optional manganese finish.

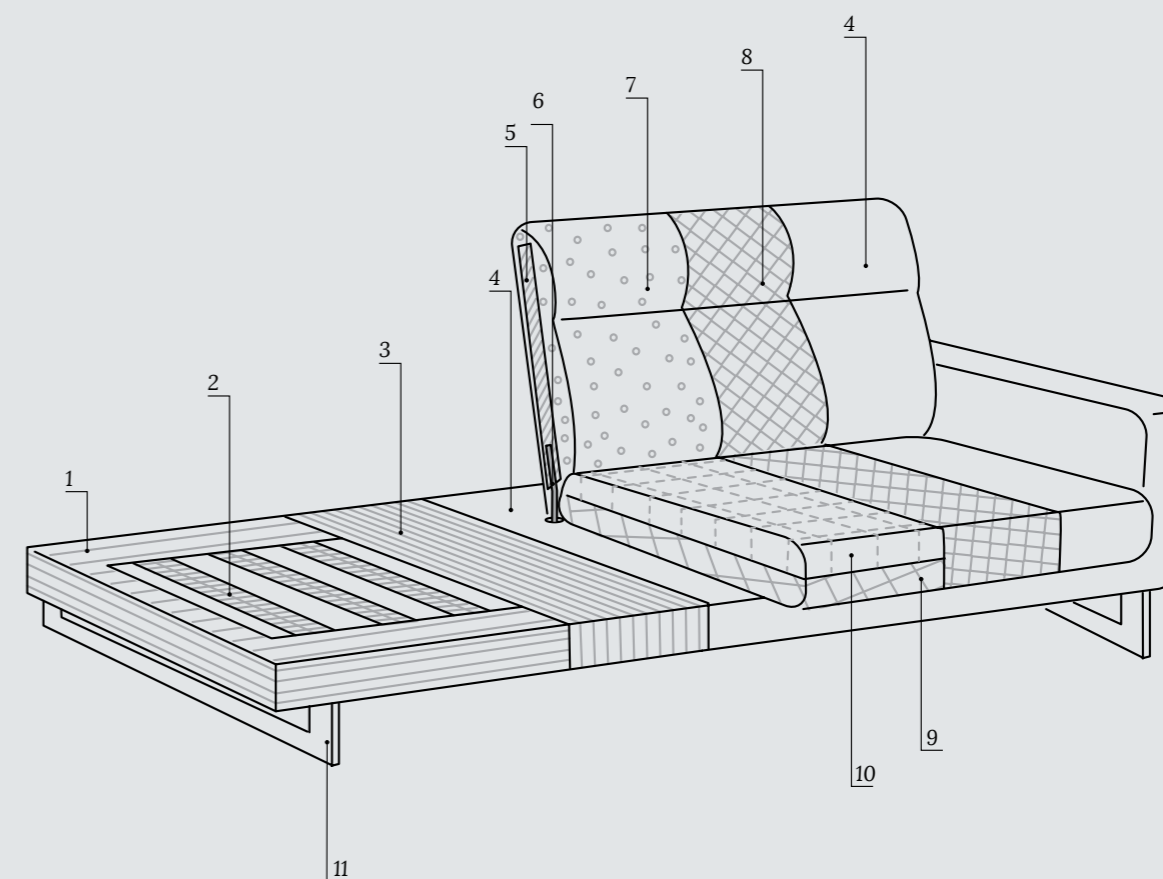

Legenda

- Struttura in legno stagionato e agglomerato.
Structure in seasoned and bonded wood.
- Molleggio seduta nastri elastici in fibra propilenica e lattice da 80 mm tesi meccanicamente.
Seat springing with elastic straps in propylene fibre and mechanically stretched 80 mm lattice.
- Vellutino accoppiato in fibra di poliestere gr. 300.
Velveteen bonded to 300 g polyester fibre.
- Rivestimento completamente sfoderabile in tessuto, parzialmente sfoderabile in pelle o ecopelle.
Fully removable upholstery in fabric, partially removable in leather or faux leather.
- Inserto in multistrato.
Multi-layer insert.
- Meccanismo schienale reclinabile in acciaio.
Reclining backrest mechanism in steel.
- Cuscino schienale in poliuretano espanso indeformabile D18.
Back cushion in D18 non-deformable polyurethane foam.
- Rivestimento in ovatta di poliestere gr. 500.
Lining in 500 g polyester wadding.
- Cuscino seduta in poliuretano espanso indeformabile D35.
Seat cushion in D35 non-deformable polyurethane foam.
- Bombatura seduta in poliuretano espanso indeformabile D28.
Top of seat in D28 non-deformable polyurethane foam.
- Piede Logic di serie, Tip optional.
Logic feet as standard, Tip feet optional.

Schienali reclinabili in molteplici posizioni / Reclining backrests with multiple positions



A seconda della collocazione del divano si potranno gestire le diverse inclinazioni dello schienale. Tenendo il divano appoggiato alla parete si potranno sfruttare le posizioni dello schienale per i primi 20° mantenendo così un ingombro totale di cm 98. Inclinando ulteriormente lo schienale oltre i 20°, aumenta di conseguenza la profondità del divano fino ad un massimo di cm 130 con un' inclinazione di 60°.

Depending on the location of the sofa, different backrest positions are possible. If the sofa is positioned against a wall, backrest positions corresponding to the first 20° can be set, thus maintaining a total footprint of 98 cm. Inclining the backrest by more than 20° consequently increases the depth of the sofa, up to a maximum of 130 cm with a 60° inclination angle.

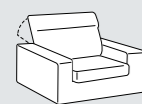

Poltrona
L 124 P 98/130 H 93



Divano
L 186 P 98/130 H 93

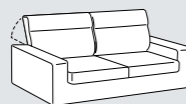

Divano
L 206 P 98/130 H 93

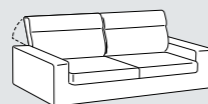

Divano
L 226 P 98/130 H 93

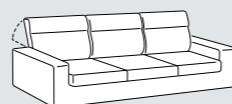

Divano
L 258 P 98/130 H 93

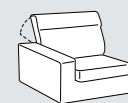

Poltrona
laterale dx/sx
L 104 P 98/130 H 93

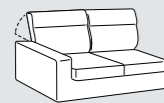

Divano
laterale dx/sx
L 166 P 98/130 H 93

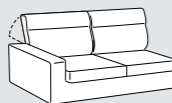

Divano
laterale dx/sx
L 186 P 98/130 H 93

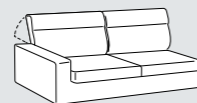

Divano
laterale dx/sx
L 206 P 98/130 H 93

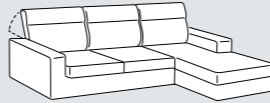

Componibile
panchetta dx/sx
L 258 P 153/185 H 93



Panchetta dx/sx
L 104 P 153/185 H 93

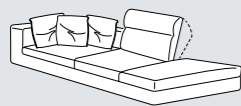

Penisola angolare c/pouff
dx/sx
L 98/130 P 230 H 93



Penisola angolare
c/Even dx/sx
L 98/130 P 225 H 93



Pouff
L 72 P 52 H 42
L 82 P 52 H 42
L 92 P 52 H 42



Cuscino
L 40 x 40



Cuscino
L 50 x 50



Cuscino
L 55 x 30

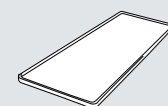

Accessorio Even
43 x 93



Finitura nera di serie.
Standard black finishes.

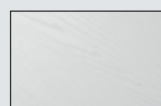

Finitura bianca optional.
Optional white finishes.

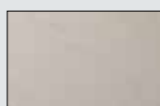

Finitura beige optional.
Optional beige finishes.



Piede Abs effetto
sospeso di serie.

Suspended-effect Abs feet
as standard.



Piede Edge finitura cromo
optional.

Optional Edge feet in
chrome finish.



Piede Steel in metallo
optional.

Optional Steel feet in
metal.



Piede Brick in legno
colore nero o beige
optional.

Optional Brick feet in
black or beige wood.

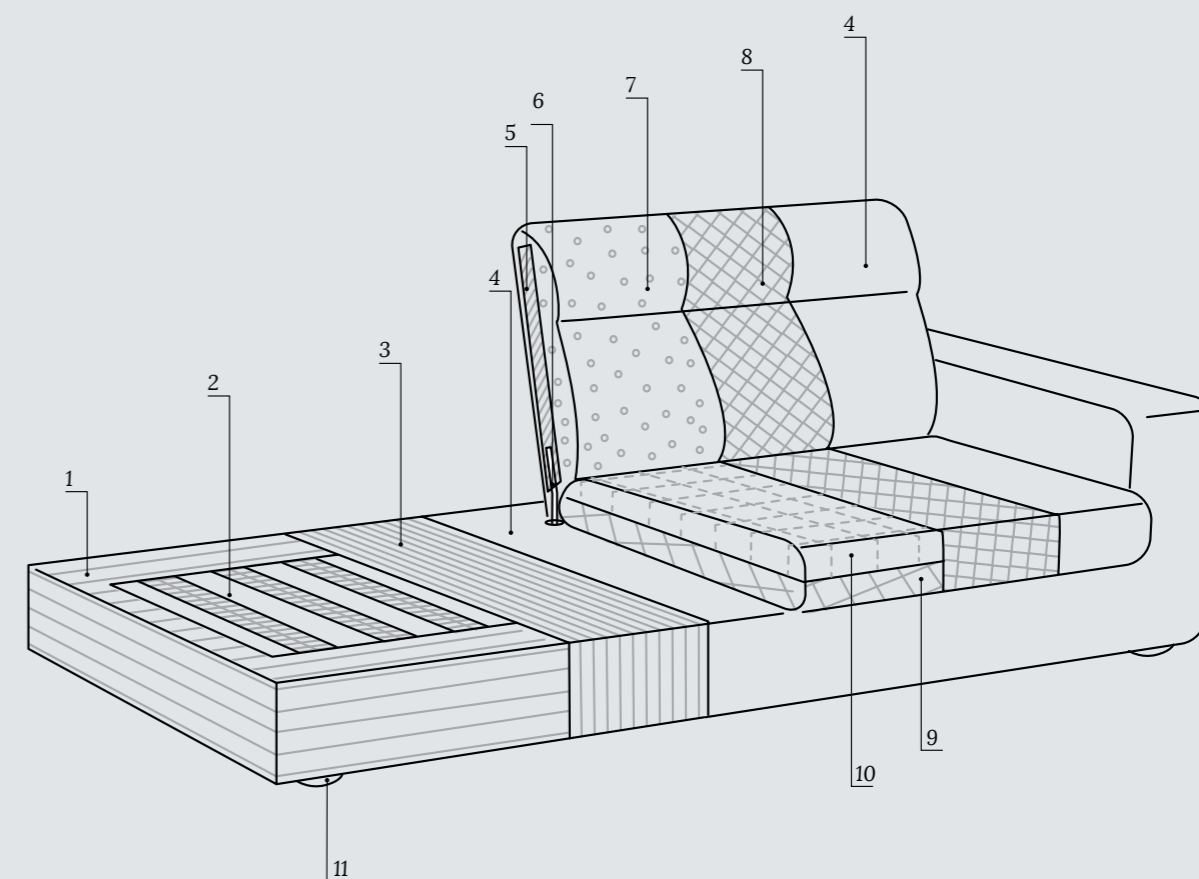

Legenda

1. Struttura in legno stagionato e agglomerato.
Structure in seasoned and bonded wood.
2. Molleggio seduta nastri elastici in fibra propilenica e lattice da 80 mm tesi meccanicamente.
Seat springing with elastic straps in propylene fibre and mechanically stretched 80 mm lattice.
3. Vellutino accoppiato in fibra di poliestere gr. 300.
Velveteen bonded to 300 g polyester fibre.
4. Rivestimento completamente sfoderabile in tessuto, parzialmente sfoderabile in pelle o ecopelle.
Fully removable upholstery in fabric, partially removable in leather or faux leather.
5. Inserto in multistrato.
Multi-layer insert.
6. Meccanismo schienale reclinabile in acciaio.
Reclining backrest mechanism in steel.
7. Cuscino schienale in poliuretano espanso indeformabile D18.
Back cushion in D18 non-deformable polyurethane foam.
8. Rivestimento in ovatta di poliestere gr. 500.
Lining in 500 g polyester wadding.
9. Cuscino seduta in poliuretano espanso indeformabile D35.
Seat cushion in D35 non-deformable polyurethane foam.
10. Bombatura seduta in poliuretano espanso indeformabile D28.
Top of seat in D28 non-deformable polyurethane foam.
11. Piede Abs di serie, Edge, Steel, Brick optional.
Abs feet as standard, Edge, Steel and Brick feet optional.

Schienali reclinabili in molteplici posizioni / Reclining backrests with multiple positions

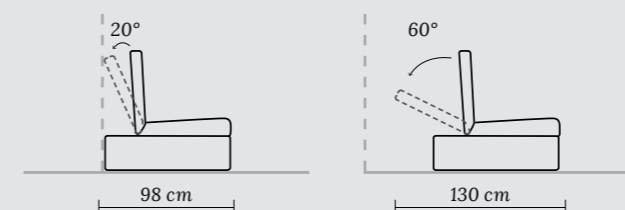

A seconda della collocazione del divano si potranno gestire le diverse inclinazioni dello schienale. Tenendo il divano appoggiato alla parete si potranno sfruttare le posizioni dello schienale per i primi 20° mantenendo così un ingombro totale di cm 98. Inclinando ulteriormente lo schienale oltre i 20°, aumenta di conseguenza la profondità del divano fino ad un massimo di cm 130 con un' inclinazione di 60°.

Depending on the location of the sofa, different backrest positions are possible. If the sofa is positioned against a wall, backrest positions corresponding to the first 20° can be set, thus maintaining a total footprint of 98 cm. Inclining the backrest by more than 20° consequently increases the depth of the sofa, up to a maximum of 130 cm with a 60° inclination angle.

ITALIER

www.italier.cz | info@italier.cz | +420 774 431 196