



*Key*

**ITALIER**

# *Key*

*La seduzione delle forme*



*PLUS:  
sistema con  
sedute estraibili (optional)  
system with pull-out seats (optional)*

Samoa produce esclusivamente in Italia



# Key

*Va in scena Key, collezione capace di sedurre e conquistare. Comodi e sinuosi schienali, abbinati alla possibilità di sedute estraibili indipendenti, identificano un programma sinonimo e garanzia di comfort assoluto.*

*Key takes centre stage, collection capable of seducing and conquering. Comfortable and sinuous backs, combined with optional independent pull-out seats, identify a range synonymous with and able to guarantee absolute comfort.*



*Key*

informazioni tecniche pag. 20



*Divano cm 218.  
Piede Steel.  
Un cuscino cm 50x50 e  
un cuscino cm 40x40.*

*218 cm sofa.  
Steel feet.  
One 50x50 cm cushion and  
one 40x40 cm cushion.*



*Divano laterale cm 180 sx con  
sedute estraibili e panchetta dx.  
Piede Brick colore nero.  
Due cuscini cm 50x50 e  
due cuscini cm 40x40.*

*180 cm left sided sofa with pull-out seats  
and right sided bench.  
Brick feet in black.  
Two 50x50 cm cushions and  
two 40x40 cm cushions.*

L'altezza importante delle schiene trova continuità di progetto nel movimento delle sedute: un unicum di forme e profili destinato a raccontare il vero benessere.



## Key

*The imposing height of the backs finds continuity in the movement of the seats: a unique panorama of forms and profiles destined to characterise true wellness.*





*Divano cm 198.  
Un cuscino cm 40x40.  
Plaid.*

*198 cm sofa.  
One 40x40 cm cushion.  
Throw.*



Key

*Divano laterale cm 180 sx con sedute  
estraiibili e penisola angolare con pouff dx.  
Piede Steel.  
Due cuscini cm 50x50 e  
tre cuscini cm 40x40.*

*180 cm left sided sofa with pull-out seats  
and right sided corner chaise with pouf.  
Steel feet.  
Two 50x50 cm cushions and  
three 40x40 cm cushions.*



Accorgimenti tecnici e funzionali  
rendono pratico ed immediato il  
movimento delle sedute.  
Ed è subito relax.

*Technical and functional solutions render the movement  
of the seating practical and swift.  
For immediate relaxation.*





*Divano cm 245 con sedute estraibili.  
Piede Brick nero.  
Due cuscini cm 50x50 e  
un cuscino cm 40x40.  
Plaid.*

*245 cm sofa with pull-out seats.  
Brick feet in black.  
Two 50x50 cm cushions and  
one 40x40 cm cushion.  
Throw.*

*Key*



*Divano laterale cm 180 s.r. e  
angolo goccia d.r.  
Piede Brick nero.  
Due cuscini cm 50x50 e  
un cuscino cm 40x40.*

*180 cm left sided sofa and  
right sided rounded corner.  
Brick feet in black.  
Two 50x50 cm cushions and  
one 40x40 cm cushion.*

Flessibilità compositiva che segue il gusto e detta i ritmi in ogni spazio. Elementi originali consentono una forte identità estetica diventando espressione di personalità e stile.



## *Key*

*Compositional flexibility that matches the taste and dictates the rhythms of each space. Original elements lead to a strong aesthetic identity, becoming an expression of personality and style.*



## *KEY*

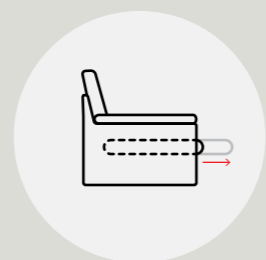

---

*PLUS:*  
*sistema con*  
*sedute estraibili (optional)*  
*system with pull-out seats (optional)*

*Informazioni*  
*Tecniche*  
*Technical Sheet*

# Key

## divani/elementi



Poltrona  
L 115 P 103 H 100



Divano  
L 158 P 103 H 100

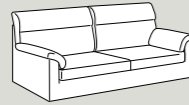

Divano  
L 178 P 103 H 100

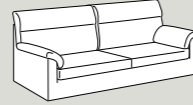

Divano  
L 198 P 103 H 100

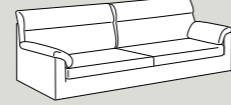

Divano  
L 218 P 103 H 100

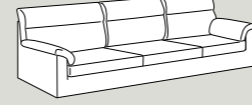

Divano  
L 245 P 103 H 100



Poltrona  
laterale dx/sx  
L 97 P 103 H 100



Divano  
laterale dx/sx  
L 140 P 103 H 100

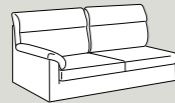

Divano  
laterale dx/sx  
L 160 P 103 H 100

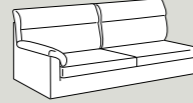

Divano  
laterale dx/sx  
L 180 P 103 H 100

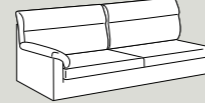

Divano  
laterale dx/sx  
L 200 P 103 H 100

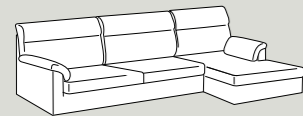

Componibile  
panchetta reversibile  
L 245 P 158 H 100



Panchetta dx/sx  
L 97 P 158 H 100

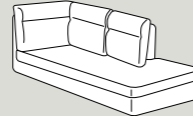

Penisola angolare  
c/pouff dx/sx  
L 103 P 225 H 100



Pouff  
L 85 P 65 H 44

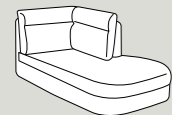

Angolo goccia dx/sx  
L 125 P 180 H 100

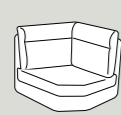

Angolo aperto  
L 125 P 125 H 100



Angolo retto  
L 103 P 103 H 100

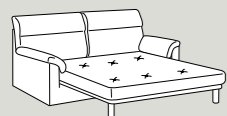

Divano letto  
L 158 P 233 H 100

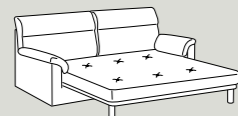

Divano letto  
L 178 P 233 H 100

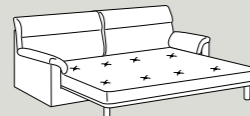

Divano letto  
L 198 P 233 H 100



Divano letto  
L 218 P 233 H 100

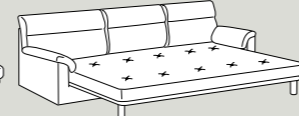

Divano letto  
L 245 P 233 H 100

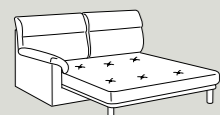

Divano  
laterale dx/sx letto  
L 140 P 233 H 100

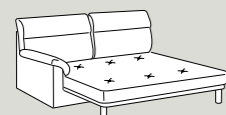

Divano  
laterale dx/sx letto  
L 160 P 233 H 100

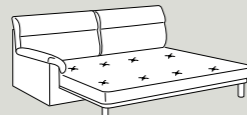

Divano  
laterale dx/sx letto  
L 180 P 233 H 100



Divano  
laterale dx/sx letto  
L 200 P 233 H 100

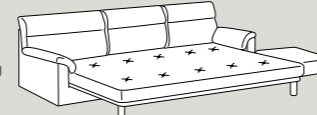

Componibile  
panchetta reversibile letto  
L 245 P 233 H 100



Cuscino  
L 40 x 40



Cuscino  
L 50 x 50

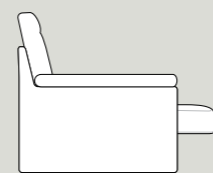

Con seduta estraibile aperta P cm 138.  
138 cm deep with pull-out seat opened.

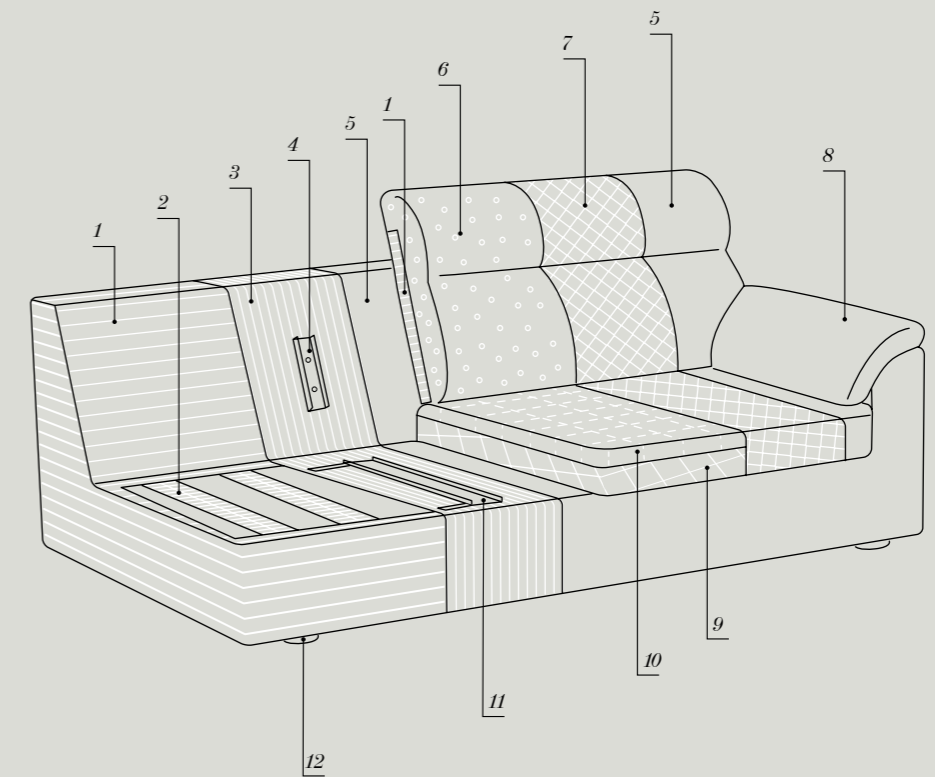

## Legenda

1. Struttura in legno stagionato e agglomerato.  
*Structure in seasoned and bonded wood.*
2. Molleggio seduta nastri elastici in fibra propilenica e lattice da 80 mm tesi meccanicamente.  
*Seat springing with elastic straps in propylene fibre and mechanically stretched 80 mm lattice.*
3. Vellutino accoppiato a fibra di poliestere gr 300.  
*Velveteen bonded to 300 g polyester fibre.*
4. Baionetta per innesto cuscini schienali.  
*Bayonet coupling for back cushions.*
5. Rivestimento completamente sfoderabile in tessuto, parzialmente sfoderabile in pelle o ecopelle.  
*Fully removable upholstery in fabric, partially removable in leather or faux leather.*
6. Cuscino schienale in poliuretano espanso indeformabile a quote differenziate D18/21.  
*Backrest cushion in D18/21 non-deformable polyurethane foam with differentiated density.*
7. Rivestimento in ovatta di poliestere gr 300.  
*Lining in 300 g polyester wadding.*
8. Cuscino bracciolo in poliuretano espanso indeformabile D21/30.  
*Armrest cushion in D21/30 non-deformable polyurethane foam.*
9. Cuscino seduta in poliuretano espanso indeformabile D32.  
*Seat cushion in D32 non-deformable polyurethane foam.*
10. Bombatura seduta in poliuretano espanso indeformabile D28.  
*Top of seat in D28 non-deformable polyurethane foam.*
11. Sistema sedute estraibili indipendenti optional.  
*Optional independent pull-out seating system.*
12. Piede Abs di serie, Steel e Brick optional.  
*Abs feet as standard, Steel and Brick feet optional.*



Piede Abs effetto  
sospeso di serie.

*Suspended-effect Abs  
feet as standard.*



Piede Steel in metallo  
optional.

*Optional Steel feet in  
metal.*



Piede Brick in legno  
colore nero optional.

*Optional Brick feet in  
black wood.*



Piede Brick in legno  
colore beige optional

*Optional Brick feet in  
beige wood.*

**ITALIER**

[www.italier.cz](http://www.italier.cz) | [info@italier.cz](mailto:info@italier.cz) | +420 774 431 196