

NEWS 2023 Una nuova collezione di prodotti, pensati come sculture dalla forte personalità, progettati con materiali e finiture ricercate e preziose. Questo è il pensiero di Alf DaFrè per arredare i tuoi spazi.

A new collection of sculptural, statement products, designed with elegant, high-end materials and finishes: this is Alf DaFrè's concept for furnishing your spaces.



Alf DaFrè®

GIOBERG / sideboard

design Gordon Guillaumier



Gioberg, non solo una madia ma una scultura che prende ispirazione dal grattacielo Pirelli di Giò Ponti. Angoli rastremati e allungati che le permettono di stare in centro stanza come protagonista dello spazio. Finiture che possono alternarsi in un piacevole gioco di rimandi tra interno ed esterno.

Gioberg is more than just a sideboard; it's a sculpture inspired by Giò Ponti's Pirelli skyscraper. Tapered, elongated corners make it the perfect centrepiece, guaranteed to steal the show. Alternate the finishes to create interplay between the interior and exterior.

design Gordon Guillaumier





Gioberg credenza / sideboard
Laccato micalizzato Nickel e Laccato Modica lucido / Micalised Nickel lacquer and High gloss Modica lacquer
L/W200,2 P/D51,8 H 78,3

Sobi poltrona / armchair
Tessuto Ricciolone 01/2 / Ricciolone 01/2 fabric
L/W87 P/D85 H71

Tsuki tavolino / occasional table
Struttura verniciato moka shine, Piano vetro bronzo satinato / Structure painted in Moka Shine / Satin-finish bronze glass top
L/W104,5 P/D76,8 H00



Gioberg credenza / sideboard
Laccato Amaranto lucido / High gloss
Amaranto lacquer
L/W200,2 P/D51,8 H 78,3





Gioberg credenza / sideboard
Laccato Anfora lucido e Azalea opaco
/ High gloss Anfora lacquer and matt
Azalea lacquer
L/W200,2 P/D51,8 H 78,3





GIOBERG

design Gordon Guillaumier

Registered design



Gioberg è una credenza con 4 ante. L'abbinamento tra due tinte laccate permette giochi di colore tra frontali e top/interno. È dotata di cerniere ammortizzate a scomparsa.

Gioberg is a sideboard with 4 doors. Combine two lacquered shades to have fun with colour across the fronts and tops/interiors. The unit is equipped with concealed soft-close hinges.

Materiali e finiture
 Top: Laccati opachi, Laccati lucidi, Laccati micalizzati
 Scocca esterna: Laccati opachi, Laccati lucidi, Laccati micalizzati

Materials and finishes
 Top: Matt lacquer, high-gloss lacquer, micalised lacquer
 External carcass: Matt lacquer, high-gloss lacquer, micalised lacquer

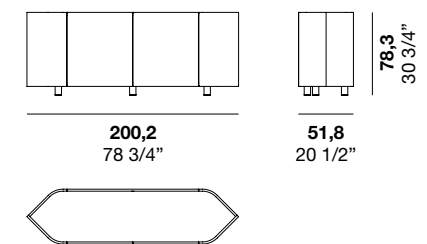

ESSE / table

design Bruna Vaccher



016

Alf DaFrè

News 2023



017

Esse, un tavolo con una forte connotazione materica e dalla forma scultorea. Due elementi curvi, che si articolano e contrappongono tra loro a formare un piacevole gioco di incastri e di luci e ombre, supportano il piano che può essere in diversi materiali: legno o vetro.

Esse is a table with strong textural appeal and sculptural form. Two curved supports unfold and contrast with each other to create an intriguing interplay of intersections and light and shadow beneath the top, which can be made of wood or glass.

design Bruna Vaccher





Esse tavolo / table
Nickel spazzolato e Fashion wood rovere
Fossile / Brushed Nickel and Fashion wood
Fossile oak
L/W280 P/D120 H75,4





Esse tavolo / table
Nickel spazzolato e Vetro trasparente
grigio / Brushed Nickel and Transparent
Grey glass
L/W280 P/D120 H75,4

Raku sedia / chair
Tessuto Nodone 1304 / Nodone 1304 fabric
L/W55,5 P/D55 H80



ESSE

design Bruna Vaccher



Un tavolo essenziale eppure espressivo. La base è costituita da due elementi simmetrici curvi in poliuretano ad alta densità che sostengono il piano in vetro o in fashion wood

A simple yet expressive table. The base is made up of two symmetrical curved elements made of high-density polyurethane which support the glass or Fashion Wood top.

Materiali e finiture

Basamento: Nickel spazzolato, Piombo spazzolato
Piano: Vetro trasparente, Vetro trasparente grigio, Rovere laccato opaco, Fashion wood

Materials and finishes

Base: Brushed Nickel, brushed Piombo
Top: Transparent glass, Grigio transparent glass, matt lacquered oak, Fashion Wood

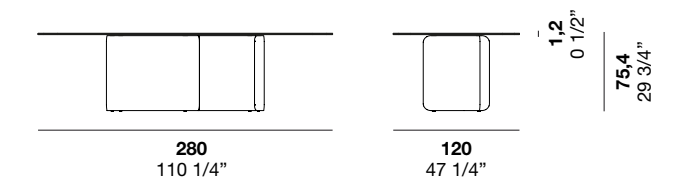
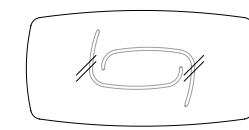
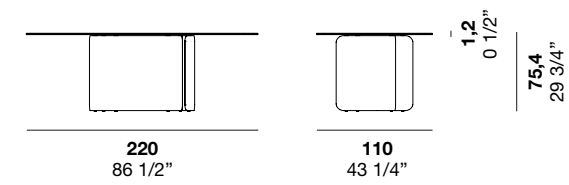
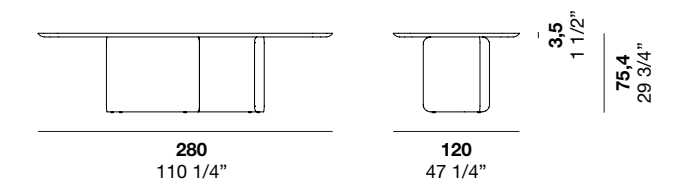
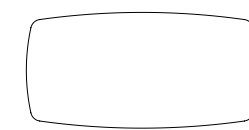
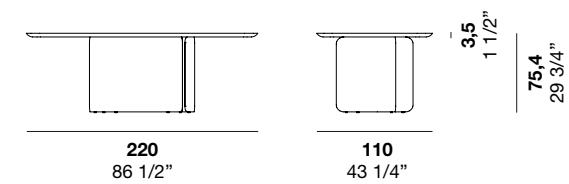

SOBI / sofa

design Gordon Guillaumier



Sobi, forme avvolgenti, curve sinuose per una famiglia di divani e poltrone configurabili con poggiatesta e pouf.

Sobi has a hugging form and curved, sinuous lines, for a collection of sofas and armchairs that can be configured with headrests and footstools.

design Gordon Guillaumier





Tsuki tavolini / occasional tables
 Struttura verniciato Moka Shine, piano
 vetro Bronzo satinato / Structure painted in
 Moka Shine, Satin finish bronze glass top
 L/W101,7 P/D99,8 H28
 L/W60 P/D54,3 H42

Gioberg credenza / sideboard
 Laccato micallizzato Nickel e Laccato
 Modica lucido / Micalised Nickel laquer
 and High gloss Modica lacquer
 L/W200,2 P/D51,8 H 78,3

Sobi divano / sofa
 Tessuto Ricciolone 01/2 / Ricciolone 01/2
 fabric
 L/W244 P/D145 H89,5

Sobi pouf
 Tessuto Ricciolone 01/2 / Ricciolone 01/2
 fabric
 L/W80 P/D75 H39

Sobi poltrona / armchair
 Tessuto Ricciolone 01/2 / Ricciolone 01/2
 fabric
 L/W87 P/D85 H71



Sobi poltrona / armchair
Tessuto Ricciolone 01/2 / Ricciolone 01/2
fabric
L/W87 P/D87 H96

Tsuki tavolino / occasional table
Struttura verniciato Moka Shine, piano
vetro Bronzo satinato / Structure painted in
Moka Shine, Satin-finish bronze glass top
L/W60 P/D54,3 H42







Sobi divano / sofa
 Tessuto Made F19 / Made F19 fabric
 L/W258 P/D91 H89,5

Sobi poltrona / armchair
 Tessuto Made F19 / Made F19 fabric
 L/W87 P/D85 H71

Tsuki tavolini / occasional tables
 Struttura verniciato Moka Shine, piano
 vetro Bronzo satinato / Structure painted in
 Moka Shine, Satin-finish bronze glass top
 L/W101,7 P/D99,8 H28
 L/W104,5 P/D76,8 H35
 L/W60 P/D54,3 H42







SOBI

design Gordon Guillaumier

Registered design



Sobi è una variegata collezione di imbottiti composta da divani, chaise longue singola, poltrona e pouf. Continuando nella ricerca, già intrapresa con la collezione Raku, verso una dimensione sofisticata e domestica del comfort. SOBI ha volumi consistenti e forme morbide e organiche.

Sobi is a diverse collection of upholstered furniture made up of sofas, a single chaise longue, an armchair and a footstool. The collection represents a continuation of the journey, which began with the Raku collection, to create a sophisticated yet homely dimension of comfort. SOBI is substantial in size and has soft, organic shapes.

Materiali e finiture

Rivestimento: Tessuti, Pelle, Ecopelle

Materiali e finiture

Rivestimento: Tessuti, Pelle, Ecopelle

Poltrona con piedini / Armchair with feet

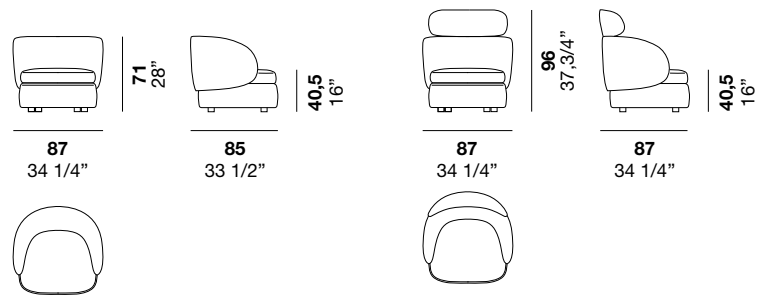

Poltrona con basamento girevole / Armchair with swivel base

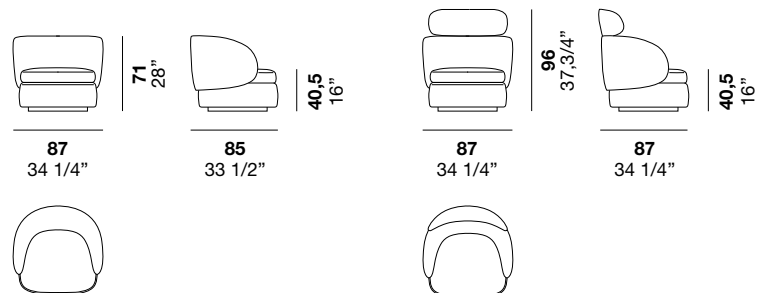

Pouf

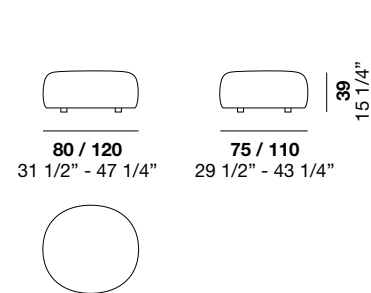

Divani / Sofa

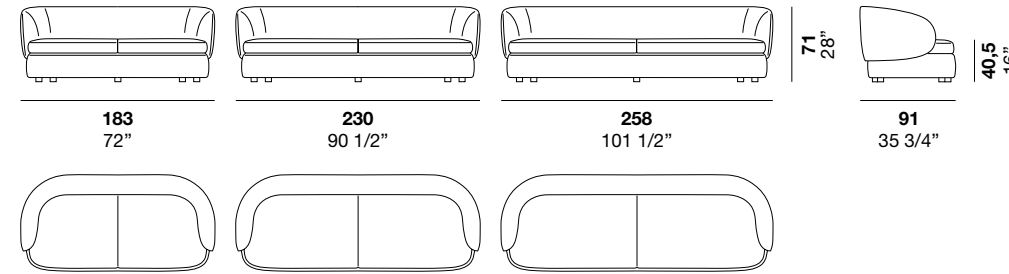

Divano con penisola / Sofa with lounge end unit

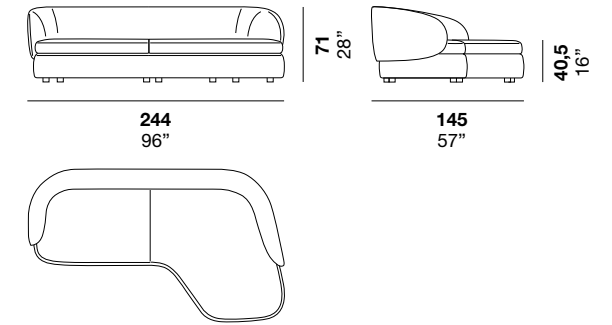

Divani con cuscini L60 cm / Sofas with cushions W. 60 cm

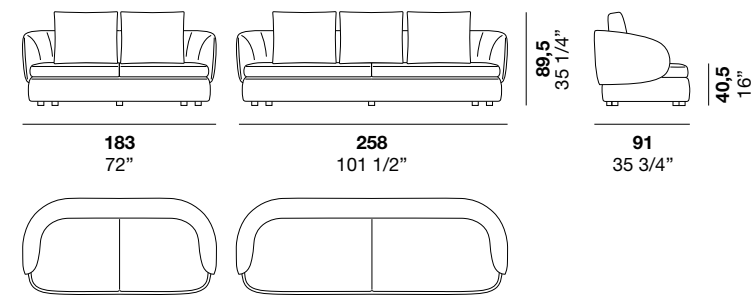

Divani con cuscini L70 cm / Sofas with cushions W. 70 cm

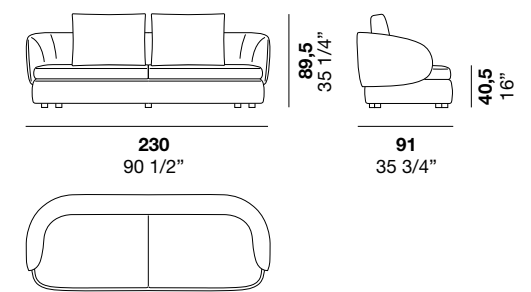

Divano con cuscini L70 cm e penisola / Sofa with cushions W. 70 cm and lounge end unit

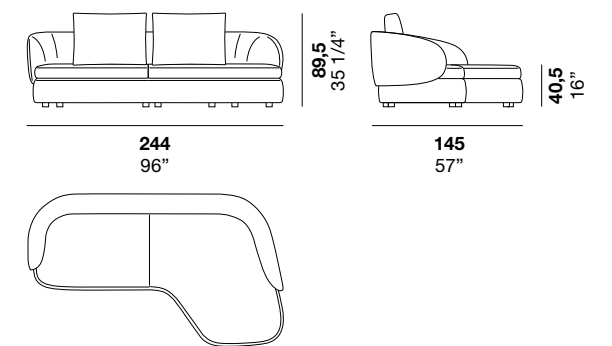

Divani con cuscini L80 cm / Sofas with cushions W. 80 cm

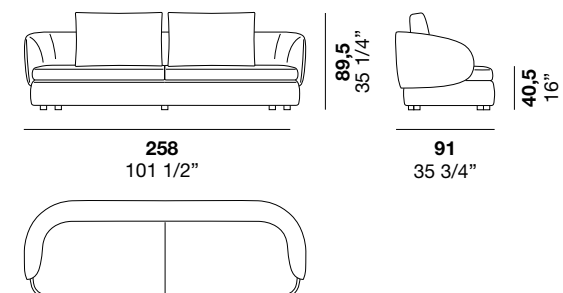

ANTIS / system

design R&D Alf DaFrè



Antis, una nuova finitura per la struttura in verniciato Nickel.
Libertà compositiva e creatività massima con un sistema
semplice nell'installazione e riconfigurabile nel tempo.

Antis: a new finish for the Nickel painted structure.
Create your composition freely and creatively
with this simple-to-install system you can keep
reconfiguring.

design R&D Alf DaFrè





Antis sistema giorno / living area composition
Struttura e porta tv verniciato Nickel,
mensole e contenitori Nobilitato Noce naturale
/ Structure and TV units Nickel painted,
shelves and storage units Noce naturale
surfaced.
L/W394 P/D46,4 H300

Alf DaFre®

ALF UNO Spa
Via S. Pio X 17
31018 Francenigo di Gaiarine
Treviso, Italy
Tel. +39 0438 997111
Fax Italia +39 0438 997245
Fax estero +39 0438 997246
www.alfdafre.it alf@alf.it



ALF UNO Spa
è certificata ISO 9001:2015
ALF UNO Spa
is certified by the ISO 9001:2015

Verifica le finiture disponibili sul nostro sito internet. / Check the finishes available on our website. / Consulte los acabados disponibles en nuestro sitio web. / Vérifiez les finitions disponibles sur notre site internet. / Überprüfen Sie auf unserer Webseite, ob die gewünschte Ausführung erhältlich ist. / Познакомьтесь с вариантами отделки на нашем интернет-сайте www.alfdafre.it

ALF UNO s.p.a. si riserva di apportare in qualsiasi momento modifiche a prodotti, misure e materiali, che ritenesse utili per esigenze di carattere produttivo e commerciale. Per essere sempre aggiornati vi invitiamo a consultare il nostro sito internet www.alfdafre.it.

LE FINITURE: I materiali utilizzati dalla nostra azienda sono selezionati tra i più affidabili per applicazione e resa estetica. Nonostante questo devono considerarsi tollerabili alcune differenze dovute alle caratteristiche stesse di materiali come essenze naturali, vetri, laccature e all'artigianalità di alcune fasi del processo produttivo che da sempre è un nostro valore aggiunto. Inoltre alcune finiture possono subire nel tempo maturazioni dovute all'azione della luce e del tempo. È importante quindi specificare se nell'ordine vi sono sostituzioni o completamenti per valutare insieme il miglior modo di procedere. Le tonalità di colore e le finiture illustrate vanno considerate puramente indicative. Verificare sempre la fattibilità dell'abbinamento finiture consultando l'interno del listino.

ALF UNO s.p.a. reserves the right to make any changes to products, measurements and materials at any time deemed useful for manufacturing and sales purposes. To stay up to date at all times, please visit our website www.alfdafre.it

FINISHES: The materials we use are selected among the most reliable products in terms of application and aesthetic rendering. Despite this, certain differences due to the very characteristics of materials such as natural wood finishes, glass and lacquers must be considered tolerable, as well as the hand-crafted nature of certain phases of the production process, which has always been one of our added values. In addition, some finishes may change over time, due to the effects of light and time. It is therefore important to specify whether there are replacements or completions in the order to assess the best way to proceed together. The finishes featured in this sample collection are purely indicative and are not available for all products. Please check in the price list if the finish is available for the chosen item. Orders will not be accepted for products with finishes not included in the price list. The colour shades and finishes illustrated herein are to be considered purely indicative. Always check the feasibility of finish combinations by consulting the price list contents.

art direction **Bruna Vaccher, Genny Canton** / graphic design **Genny Canton Studio** / photo **Paolo Contratti, Paolo Burato, Riccardo Munarin** / styling **Rosanna Bignucolo, Claudia Barberi** / separations **Luce srl**

thanks to **G.T.Design, Panzeri**