

**Sofa / armchair / pouf / occasional tables  
/ tables / chairs / sideboards cabinets /  
bookcases / mirrors / beds / bed groups  
/ modular system / wardrobes / external  
drawer-unit island / walk-in closets / kitchens**

**THE ITALIAN HOME**

**ITALIER**

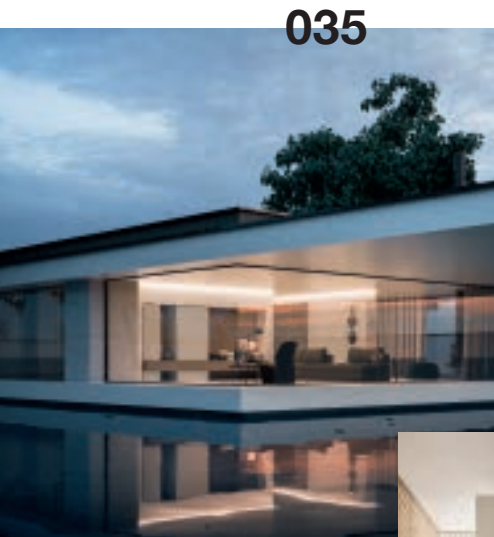

035



116



011



124



183

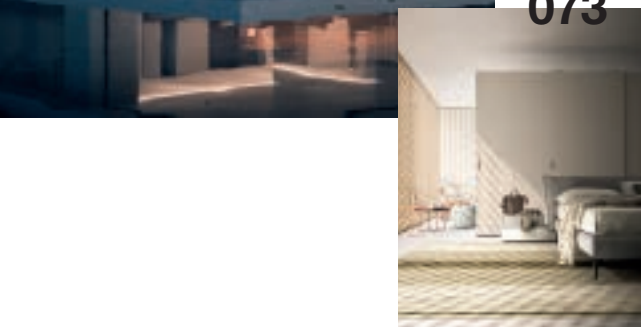

073

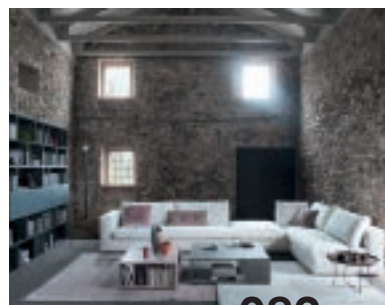

082



150



197

**004 La materia delle cose**  
Pareti e pavimenti come geometrie a contrasto

**026 Home pleasure**  
Il piacere di tornare a casa

**040 Private refuge**  
Un rifugio privato da vivere in intimità

**050 Una scatola bianca**  
Un loft che è sintesi tra rigore nordico e anima d'artista

**060 Legno / Cemento**  
Un ideale rifugio tra calde pareti materiche

**072 Gioco d'ombre**  
Un brise soleil metallico modula la luce all'interno della casa

**088 Presente passato**  
Innesti nella memoria di gusto contemporaneo

**087 Rigore moderno**  
Affacciata sul lago con grandi vetrate la casa dagli interni scuri e minimal

**103 Parete di colore**  
Un progetto che sceglie la sobrietà ma vive di dettagli

**113 Luce dall'alto**  
Illuminazione naturale, morbida e diffusa in un paesaggio nordico

**122 Nuovi scenari**  
Un appeal internazionale che combina modernità e tradizione

**128 Cucina in scena**  
Un dialogo senza confini tra living e cucina

**137 Equilibrio speciale**  
Un living raccolto e accogliente

**142 Modernismo espressivo**  
Il cemento si mimetizza

**154 Green minimal**  
Il rapporto tra la pietra naturale e il verde è al centro del progetto

**169 Nuove atmosfere**  
Sofisticata coerenza formale

**183 In&Out**  
Un gioco di rimandi fra spazio interno ed esterno

**194 Il profumo del tempo**  
Omaggio alla tradizione artigianale italiana

**207 Marmo**  
New York. Doppia altezza spettacolare per far spazio a luce e socialità

**214 Slow life**  
Materiali naturali e design d'autore

**227 Rigore puro**  
Eleganza raffinata degli interni

# LA MATERIA DELLE COSE

Pareti e pavimenti  
come geometrie a contrasto









010

**Alf DaFre**

**Valdesign**  
DESIGN

THE ITALIAN HOME



**Kendo** credenza / sideboard  
**Fyra** tavolo / table  
**Esagona** specchiera / mirror

**Raku** sedia / chair

011



012

**Alf DaFre™**

**Valdesign**  
DESIGN

THE ITALIAN HOME



**Fyra** tavolo / table  
**Raku** sedia / chair

013







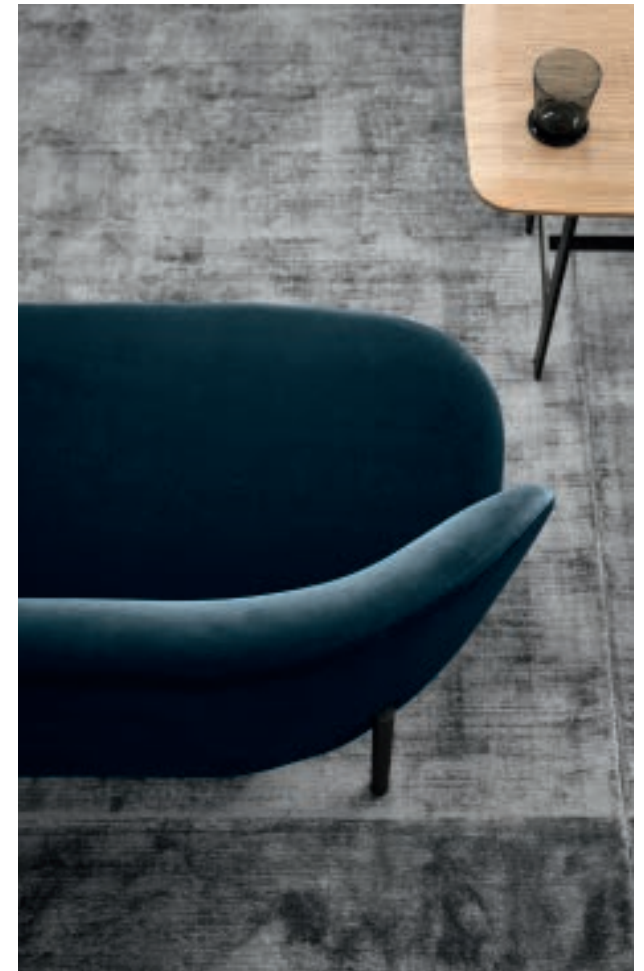



020

**Alf DaFre**

**Valdesign**  
DESIGN

THE ITALIAN HOME



**Neyo** letto / bed

021

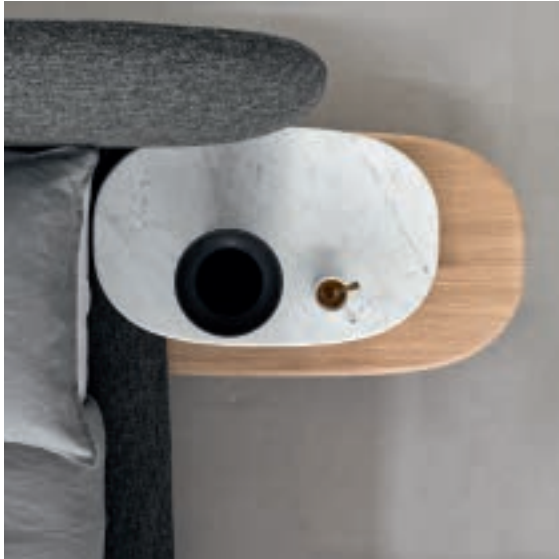





# HOME

Il piacere di tornare a casa

# PLEASURE













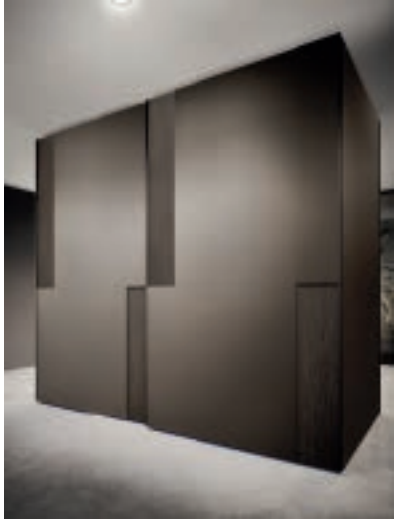

036

**Alf DaFre**

**Valdesign**  
com

THE ITALIAN HOME



**Mixer** armadio / wardrobe

037



# PRIVATE

Un rifugio privato  
da vivere in intimità

# REFUGE







044

**Alf DaFre**

**Valdesign**  
com

THE ITALIAN HOME



**Rigadin** credenza / sideboard

045









# UNA SCATOLA

Un loft che è sintesi tra  
rigore nordico e anima d'artista

# BIANCA













# LEGNO / CEMENTO

Un ideale rifugio tra  
calde pareti materiche







062

**Alf DaFre™**

**Valdesign**  
COME

THE ITALIAN HOME



**Aliante** tavolo / table  
**Corium** sedie / chair

**Metropolis** madia / cabinet  
**Denny** / pouf

063









070

**Alf DaFre**

**Valdesign**  
DESIGN

THE ITALIAN HOME



**Haiku** specchiera / mirror

071

# GIOCO D'OMBRE

Un brise soleil  
metallico  
modula la luce  
all'interno della casa.











078

Alf DaFre™

Valdesign  
s.p.a.

THE ITALIAN HOME



Poker armadio / wardrobe  
Up libreria / bookcase

079

# PRESENTE

Innesti nella memoria  
di gusto contemporaneo

# PASSATO









# RIGORE MODERNO

Affacciata sul lago  
con grandi vetrate  
la casa dagli interni scuri  
e minimal









092

**Alf DaFre**

**Valdesign**  
DESIGN

THE ITALIAN HOME



**Soho** cucina / kitchen

093













# PARETE DI

Un progetto che sceglie  
la sobrietà ma vive di dettagli

# COLORE















# LUCE

Illuminazione naturale,  
morbida e diffusa  
in un paesaggio nordico

# DALL'ALTO









# NUOVI

Un appeal internazionale che combina  
modernità e tradizione

# SCENARI









# CUCINA

Un dialogo senza confini  
tra living e cucina

# IN SCENA











# EQUILIBRIO

Un living raccolto e accogliente

# SPECIALE









Il cemento si mimetizza

# MODERNISMO ESPRESSIVO















MINIMAL

Il rapporto tra  
la pietra naturale e  
il verde è al centro  
del progetto









**Shift lounge** poltroncina / armchair  
**Shift ottoman** poggiapiedi / footstool  
**Malmo** tavolino / occasional table











# NUOVE

Sofisticata coerenza formale

# ATMOSFERE

















# IN & OUT

Un gioco di rimandi  
fra spazio  
interno ed esterno

















Omaggio alla tradizione  
artigianale italiana

# IL PROFUMO DEL TEMPO





196

**Alf DaFre**

**Valdesign**  
DESIGN

THE ITALIAN HOME



**Copenhagen** divano / sofa  
**Wok** tavolino / occasional table  
**Moca** tavolino / occasional table

**Tuft** tavolino / occasional table  
**Le20** tavolo / table  
**Corium** sedia / chair

**Cartalegno** credenza  
 / sideboard

197













# MARMO

New York.  
Doppia altezza  
spettacolare  
per far spazio a  
luce e socialità









# SLOW LIFE

Materiali naturali e design d'autore

















# RIGORE PURO

Eleganza raffinata  
degli interni

















**CALIFORNIA** → P. 006 / 009 / 030 / 032 / 033 / 082 / 083 / 096 / 140 / 141 / 150 / 151 / 183 / 208 / 228 / 229

California è un divano dalle forme regolari e dalla vasta modularità. Ampiamente componibile soddisfa le più svariate esigenze nella zona living grazie alle molteplici librerie in legno. Sono disponibili inoltre piedi in legno.

California is a regular-shaped sofa affording maximum modularity. Extensively modular, it accommodates the most diverse living room needs, thanks to the multiple wooden bookcases. Wooden feet are also available.



**COPENAGHEN** → P.087 / 089 / 094 / 104 / 105 / 116 / 117 / 138 / 155 / 156 / 157 / 196 / 197 / 198 / 199

Copenaghen, l'idea quella di un prodotto sincero, di dimensioni contenute ma in grado di accoglierci con grande comfort e rispondere a tutte le necessità della vita quotidiana. Leggero, lineare e visivamente composto per un abitare contemporaneo. Disponibile in cinque larghezze e in versione poltrona.

Copenaghen: the idea is to create an authentic product that is compact in size but still able to offer great levels of comfort, and respond to all of our everyday needs. Light, linear and ordered, for contemporary living. Available in five widths and as an armchair.



**LADIGUE** → P. 084 / 085

Ladigue è un divano componibile dallo stile soft e dall'aspetto morbido ed accogliente. Un design valorizzato da pence e morbide pieghe. È possibile trasformare la profondità della seduta a proprio piacimento con un semplice gesto; una seduta "su misura" in grado di adattarsi al millimetro alle esigenze di tutti.

Ladigue is a modular sofa with soft style and a comfortable, inviting appearance. The design features darts and gentle folds. The depth of the seat can be adjusted to suit your preferences in one simple step; a tailor-made seat that adapts to everyone, down to the finest detail.



**NEVADA** → P. 144 / 145 / 149

Nevada è un divano componibile che con la sua immagine sobria e informale esprime il perfetto equilibrio tra tradizione e contemporaneità. Le forme sono classiche ma la particolare geometria del bracciolo, la dimensione dei cuscini seduta, e l'essenzialità dei piedini in metallo rimandano definitivamente al gusto contemporaneo.

Nevada is a modular sofa that, with its simple, informal look, expresses a perfect balance between tradition and modernity. The shapes are classic but the unusual geometry of the armrests, the size of the seat cushions, and the simplicity of the metal feet definitely evoke a contemporary flavour.



**OREGON**

Oregon è un divano caratterizzato dalla particolare sagoma dei braccioli che creano un effetto di continuità estetica e funzionale con lo schienale. Vasta la modularità, completa di moduli angolo, chaise longue, poltrone e pouf.

The Oregon sofa stands out for the particular shape of its armrests, which create a feeling of styling and functional continuity with the seat back. Affording generous modularity, complete with corner units, chaise longue, armchairs and footstools.



**OSLO**

Oslo è un divano in cui le morbide imbottiture si fondono alla forma regolare di base e braccioli. Piacevolmente sospeso da piedi in metallo verniciato, Oslo è disponibile in cinque larghezze e due varianti di poltrona.

The Oslo sofa features soft padding that appears to sink into the regular shape of its base and armrests. Pleasantly suspended by painted metal feet, Oslo is available in five widths and two armchair versions.



**STOCCOLMA**

Stoccolma è un divano in cui le morbide imbottiture si fondono alla forma regolare di base e braccioli. Caratterizzato da una gonna che arriva a terra, Stoccolma è disponibile in cinque larghezze e due varianti di poltrona.

The Stoccolma sofa features soft padding that appears to sink into the regular shape of its base and armrests. Distinguished by a floor-length valance, Stoccolma is available in five widths and two armchair versions.



**JET SET**

Jet Set è una poltroncina imbottita e sfoderabile (nella versione tessuto ed ecopelle) disponibile nelle varianti con piedi, con basamento girevole e con gonna. Il pratico poggiatesta è il suo complemento ideale.

Jet Set is a padded armchair with removable cover (in the fabric and ecoleather version), which is available in versions with feet, with swivel base and with valance. The practical footstool is its perfect companion.



**OLIVIA** → P. 110 / 111 / 207

Olivia è una poltrona e poggiatesta imbottiti con basamento girevole in metallo. Il design di Olivia è caratterizzato dalla forma "aperta" con un accenno di deformazione ad indicare la possibilità ad accogliere le più svariate posizioni.

Olivia is a padded armchair and footstool pair with a metal swivel base. Olivia's design is open and features a hint of contortion to show how it can be suited to the most varied of positions.



**UTAH**

Utah è un divano dalla forma rigorosa, caratterizzato da piacevoli "intersezioni" tra sedute, schienali e braccioli. Appoggiato a quattro eleganti piedi in metallo verniciato, è completato nella modularità da angoli, chaise longue, poltrone e pouf.

The Utah sofa has a strikingly simple shape, which stands out for its enchanting "crossroads" between seat cushions, seat backs and armrests. Resting on four stylish painted metal feet, its modularity is completed by corner units, chaise longue, armchairs and footstools.



**ODETTE** → P. 034 / 035 / 095 / 123 / 140 / 141 / 163

Odette è una poltroncina imbottita e sfoderabile caratterizzata da un unico volume in cui seduta e schienale risultano separate e al tempo stesso continue. Un design dalla forte personalità che ricorda la silhouette di un cigno.

Odette is a padded armchair with removable cover. It forms a single shape where the seat and back are both one and separate. This feature piece also evokes the silhouette of a swan.



**DENNY** → P. 063 / 073 / 121 / 126 / 127 / 139 / 144 / 151 / 231

Denny è un pouf imbottito e sfoderabile (nelle versioni tessuto) disponibile in tre misure. Caratterizzato da forme tondeggianti e rastremate funge da seduta o pratico appoggio.

Denny is a padded footstool with removable cover (in the fabric version), which is available in three sizes. It is distinguished by rounded and tapered shapes, and it can be used as either a seat or a practical rest.



CEPPO → P. 204 / 222 / 223

Ceppo è un tavolino ricavato da un unico pezzo di tronco di rovere cresciuto sulle rive dei fiumi. Segato, scortecciato e levigato è distinto da un caldo colore naturale e fini spaccature.

The Ceppo occasional table is built using a single piece of oak trunk grown on riverbanks. Sawn, debarked and smoothed, it stands out for its warm natural colour and fine cracks.

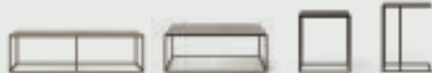

KOBE → P. 096 / 141 / 155 / 156 / 157 / 183 / 184 / 185 / 198 / 199

Kobe è un tavolino quadrato o rettangolare con struttura in metallo verniciato e piano legno. Estremamente pulito nella linea è disponibile in quattro misure.

Kobe is a square or rectangular occasional table with a painted metal structure and a wooden top. It has an extremely clean-cut silhouette and it is available in four sizes.



NORMAN → P. 032 / 082 / 083 / 208

Norman è un tavolino con struttura legno disponibile in versione quadrata o rettangolare. Il suo design si caratterizza per l'inserito piano in contrasto disponibile anche in resina cementizia.

The Norman occasional table has a wooden structure and it is available in either the square or the rectangular version. Its design stands out for its contrasting top insert, which is also available in cement resin.



RIM → P. 046 / 047 / 095 / 123 / 124

Rim è un tavolino con anta o vano a giorno, si differenzia per la linea curva e le dimensioni compatte. La possibilità del bicolore ne esalta le linee e ne amplia la versatilità.

Rim is a table with either a door or open compartment. It stands out for its curved lines and compact size. The two-tone option brings out its shape and makes it a truly versatile piece.



LIFE → P. 120 / 141 / 192 / 198 / 223 / 227 / 229

Life è un tavolino con struttura legno disponibile in tre varianti: rotondo con tre gambe e rettangolare con quattro gambe in due misure.

The Life occasional table has a wooden structure available in three versions: round with three legs, or rectangular with four legs, in two different sizes.



MALMO → P. 018 / 019 / 105 / 116 / 117 / 159

Nati per affiancare la famiglia di divani Copenaghen, i tavolini Malmo sono caratterizzati da grande leggerezza e semplicità. Una esile struttura in metallo con raccordi arrotondati sostiene un piano in legno con una delicata forma smussata. Sono proposti in forme e altezze diverse, e con una grande varietà di laccature, per offrire la massima flessibilità d'uso.

Created to complement the Copenaghen sofa family, Malmo tables are simple and lightweight. A slender metal structure with rounded fittings supports a wooden top featuring a delicate rounded shape. They come in different shapes and heights – and in a large range of lacquered finishes – so you can use them in many different ways.



TUFT → P. 034 / 035 / 073 / 082 / 083 / 084 / 085 / 163 / 177 / 197 / 207 / 208 / 231

Tuft è un tavolino rotondo con struttura in metallo disponibile in 2 misure. La parte superiore è realizzata come un "vassoio" a cui può essere abbinato un piano in legno.

Tuft is a round occasional table with a metal structure available in 2 sizes. The top is made like a "tray", which can be combined with a wooden surface.



WOK E WOK BOX → P. 006 / 007 / 009 / 084 / 087 / 089 / 094 / 123 / 127 / 138 / 151 / 177 / 192 / 196 / 197 / 199

Wok è un tavolino rotondo con struttura in metallo. Wok Box si differenzia per il contenitore legno nella parte superiore chiusa da un coperchio che all'occorrenza diventa un pratico vassoio con impugnatura sagomata.

Wok is a round occasional table with a metal structure. Wok Box differs in that it has a wooden storage unit at the top, which is topped off by a cover that turns into a practical tray with a shaped handle when necessary.



MOCA → P. 007 / 009 / 030 / 066 / 067 / 149 / 150 / 197 / 199

Moca è un tavolino rotondo con struttura in metallo verniciato e piano legno. Moca è disponibile in due misure.

The Moca round occasional table has a painted metal structure and a wooden table top. Moca is available in two sizes.



NEYŌ → P. 005 / 008 / 103 / 145

Complemento ideale sia per la zona giorno che per la camera da letto il tavolino Neyō è caratterizzato dalla struttura in metallo finitura Moka Shine e il piano dalla linea curva disponibile nelle varianti Fashion wood, rovere laccati opachi o marmo di Carrara.

The ideal complement for both the living area and the bedroom, the Neyō occasional table has a metal frame in the Moka Shine finish and a curved top available in Fashion Wood, matt lacquered oak or Carrara marble.



ALIANTE → P. 062 / 090 / 091 / 215 / 218 / 219

Aliante è un tavolo con struttura in metallo e piano quadrato o rettangolare, disponibile in versione fissa o allungabile. Questo tavolo si caratterizza per la presenza di "calzini" legno, in diverse finiture abbinabili a proprio gusto ai laccati della parte superiore.

The Aliante table has a metal structure and table top, either square or rectangular, and it is available in the fixed or extending version. This table stands out for the presence of wooden "socks", which are available in various finishes to match the lacquered upper part of the legs according to personal taste.



BOARD → P. 200 / 201

Board è un tavolo con struttura metallo e piano legno, rettangolare, disponibile in versione fissa o allungabile. Nel tavolo Board convivono alla perfezione un basamento in metallo verniciato di forma geometrica e un piano in rovere antico nodato disegnato da bordi con una sagomatura irregolare.

Board is a rectangular table with a metal structure and a wooden table top, and it is available in the fixed or extending version. In the Board table, a geometrically shaped metal base finds the perfect partner in a knotted aged-look oak table top designed by irregular-shaped edges.



**CARTESIO 2.0** → P. 032 / 033 / 160 / 161

Cartesio 2.0 è un tavolo con struttura in legno, rettangolare e allungabile. Cartesio 2.0 si distingue per il piano e le allunghe di forte spessore e per la particolare conformazione del basamento in cui le gambe inclinate si collegano nella parte inferiore creando una "struttura chiusa".

The Cartesio 2.0 table has a wooden structure, and it is either square or rectangular. Cartesio 2.0 stands out for the extra thick table top and extensions and for the particular shape of the base, with tilted legs that join at the bottom to form a "closed structure".



**FYRA** → P. 011 / 012 / 013 / 146 / 147

Il tavolo è caratterizzato da geometrie sofisticate e da "stacchi" tra gli elementi che rendono la composizione molto espressiva. Il piano, definito da una linea mista a metà tra retta e curvilinea, è diviso in 4 quadranti che creano con le venature del legno un motivo tipico della tradizione ebanista.

The table features sophisticated geometry and intervals between the elements that make the composition very expressive. The top, defined by a line that is a mixture of half straight and half curvilinear, is divided into 4 quarters which create a typical design from traditional carpentry with the wood grain.



**FUSELLO** → P. 051 / 052 / 053 / 081 / 234 / 235

Il fusello è il rocchetto utilizzato nella lavorazione del pizzo. Alla sua immagine morbida si ispira la forma delle gambe che caratterizzano la struttura in legno del tavolo. Il piano sembra quasi "sospeso" sulla struttura che diventa elemento centrale, plastico ed espressivo della composizione.

The fusello or spindle is the bobbin used for making lace. Its soft look is what inspired the shape of the legs that characterise the wooden structure of the table. The top almost seems "suspended" on the structure which becomes a central, sculpted and expressive element of the composition.



**JAG** → P. 170 / 171

Jag è un tavolo con struttura in metallo verniciato e piano legno, quadrato o rettangolare, disponibile in versione fissa o allungabile. Il piano dalla particolare conformazione "dogata" disponibile in diverse finiture può essere abbinato ai laccati del basamento.

The Jag table has a painted metal structure and a wooden table top, either square or rectangular, and it is available in the fixed or extending version. The special "slatted" look of the table top, which is available in various finishes, can be combined with different colour lacquers for the base.



**LE20** → P. 030 / 031 / 135 / 195 / 197 / 229

Le 20 è un tavolo con struttura legno di forma rotonda disponibile in due misure. Le gambe inclinate sorreggono il piano in cui un gioco grafico dà vita ad un orologio che segna le otto di sera.

Le 20 is a table with a round wooden structure and it is available in two sizes. The tilted legs support the table top, where a graphic game takes the shape of a clock set at eight o'clock in the evening.

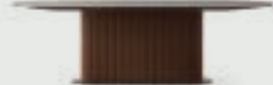

**RIGADIN** → P. 041 / 042 / 043

Il legno massello è l'essenza di Rigadin. Una collezione preziosa e vera, dove la bellezza è forma ma anche sostanza. Pregio ed essenzialità sono plasmati in modo personale, connessi da ispirazione e artigianalità. Disponibile in versione con top metallo o marmo / pietra.

Solid wood is at the heart of Rigadin, an authentic high-value collection. Here, beauty is in the substance, as well as the form. High quality and simplicity are shaped to create a personalised end result, connected through inspiration and craftsmanship. Available with a metal or marble / stone top.

## SEDIE / CHAIR



**AILERON** → P. 97 / 134 / 135 / 200 / 201 / 215 / 217 / 218 / 219

La sedia Aileron introduce nel mondo domestico, una soluzione tipica delle sedute ergonomiche da ufficio, ovvero un movimento dello schienale che, inclinandosi dolcemente, asseconda naturalmente il movimento della schiena in appoggio. Il meccanismo, assai semplice e minimale.

The Aileron seat introduces a feature typically found on ergonomic office chairs into the home: a back rest that reclines gently to move naturally in sync with your back. The mechanism is simple and discreet.



**CORIUM** → P.032 / 033 / 062 / 081 / 146 / 147 / 160 / 161 / 170 / 171 / 195 / 197 / 210 / 211 / 234 / 235

Corium è una sedia dalla forma molto contenuta, disponibile con un rivestimento in cuoio, tessuto, pelle o ecopelle e con uno schienale alto 95 cm o più contenuto, 70 cm.

Corium is a highly compact seat, available upholstered in leather, fabric or ecoleather and with a high (95 cm) or low (70 cm) back rest.



**ELEKTA**

Elekta è una sedia con struttura in legno, seduta e schienale imbottiti. La particolare conformazione dello schienale crea, di lato, un piacevole collegamento alla struttura e tramite uno scanso ne permette agevolmente lo spostamento.

The Elekta chair has a wooden structure and padded seat and back. The special shape of the seat back creates a pleasant connection with the structure on one side, and makes it easy to move thanks to a recess.



**ESEDRA**

Esedra è una sedia con struttura in legno massello, seduta e schienale imbottiti. La forma regolare della struttura supporta dei pannelli imbottiti particolarmente sottili ma confortevoli.

The Esedra chair has a solid wood structure and padded seat and back. The regular shape of the structure supports the padded panels which are especially slender yet ultimately comfortable.



**KARINA**

Karina è una sedia con struttura in legno disponibile nella variante con seduta imbottita. Karina può inoltre essere "celata" con una veste in tessuto creata sulle sue forme.

The Karina chair has a wooden structure and it is available in the version with padded seat. Karina can also be "concealed" by a fabric floor-length cover created with the exact same shape.



**KAROL / KAROL WOOD** → P. 041 / 042 / 043 / 141 / 162 / 212 / 229

Karol e Karol wood sono sedie imbottite e sfoderabili nelle versioni in tessuto. Karol wood abbina gambe in legno ai rivestimenti di seduta e schienale.

Karol and Karol wood are padded chairs with removable covers in the fabric version. Karol wood combines wooden legs with upholstered seat and back.



**RAKU** → 005 / 006 / 008 / 012 / 013 / 018 / 019 / 103 / 105 / 143 / 148

La collezione di sedute imbottite Raku – che comprende poltrona + pouf, divanetto, sedia e panca – ha un'immagine contemporanea ed essenziale. Disponibile con rivestimento in pelle e in tessuto, Raku è perfetta per regalare un tocco di comfort alla zona giorno, come alla zona notte.

The Raku collection of upholstered seats – which includes an armchair + footstool, small sofa, chair and bench – has a simple, contemporary look. Available with leather and fabric upholstery, Raku is perfect for adding a touch of comfort to the lounge and bedroom.



**SHIFT** → P. 051 / 053 / 056 / 156 / 157 / 158 / 159 / 164

Shift è una famiglia di sedute in frassino composta da sedia e poltrona lounge con o senza pouf poggiatesta. La collezione è proposta con rivestimento di seduta e schienale in tessuto dai colori caldi e naturali.

Shift is a seating collection in ash wood, composed of a chair and a lounge armchair with or without a footstool. The collection is available with the seat and backrest lined with fabric in warm and natural colours.



**KENDO** → P. 010 / 011

Kendo è una credenza caratterizzata da un particolare gioco geometrico delle ante: ciascuna anta presenta un taglio a 30° che la divide in due parti non perfettamente complanari ma lievemente disassate, regalando alla superficie un raffinato effetto di chiaroscuro. Kendo è proposto nelle finiture nobilitate, Fashion wood e laccati. È eventualmente disponibile anche con ante, struttura e top in finiture o colore differenti.

Kendo is a sideboard with unusual geometric doors: each one has a 30° cut that divides it into two parts that are not on exactly the same plane but instead slightly off-centre, lending the surface a refined light and shade effect. Kendo is available in a surfaced, Fashion Wood or lacquered finish. It is also available with the doors, frame and top in different finishes or colours.

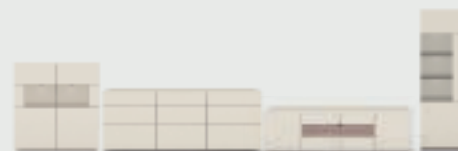

**METROPOLIS** → P. 063 / 169 / 170 / 171

Metropolis è un programma di credenze, madie, vetrine e porta TV vasto e articolato. Dotato di ante e cassetti con chiusura assistita dispone di versioni con vani a giorno o con vetrina, top in vetro o in finitura.

Metropolis is an extensive and diversified range of sideboards, cabinets, display cabinets and TV units. Featuring doors and drawers with assisted closing, some versions come with open compartments or glass doors, and with a glass or matching finish top.



**VIKY** → P. 030 / 031 / 049

Viky è una sedia con struttura in legno massello di rovere in cui lo schienale prosegue sui lati dando forma ai braccioli. Viky è disponibile in due varianti: seduta e schienale verticale imbottiti (Viky 2), seduta e schienale orizzontale imbottiti (Viky 3).

The Viky chair has a solid oak wood structure, where the armrests are a continuation of the seat back. Viky is available in two versions: with a padded seat and vertical seat back (Viky 2), and with a padded seat and horizontal seat back (Viky 3).



**MUSA** → P. 094 / 095

Musa è disponibile in versione credenza, madia o vetrina. L'interno può essere laccato e dotato, nel caso della credenza, di una pratica cassettiera.

Musa is available in the sideboard, cabinet or display cabinet version. The interior can be lacquered and fitted - in the sideboard version - with a practical drawer unit.



**NOBEL** → P. 163 / 207

Nobel è disponibile in versione credenza o madia su piedi metallo verniciato, offre una vasta scelta di misure e possibilità di soluzioni con ante, cesti e cassetti. L'apertura è a scelta con push pull o pomolo in pelle. Il design dei piedi in metallo permette una perfetta abbinabilità con il divano Oslo.

Nobel is available as a sideboard or cabinet, with painted metal feet, in a broad range of sizes and different solutions with doors and drawers. The opening mechanism can be chosen from a choice of push-pull or a leather knob. The design of the metal feet makes it the perfect match for the Oslo sofa.

## MADIE CREDENZE / sideboards cabinets



**CARTALEGNO** → P. 195 / 197 / 215 / 217 / 218 / 219

Cartalegno è una collezione di mobili contenitori composta da madie e credenze dal design unico e personale. Si distingue per le superfici rigate piacevoli al tatto e spigoli scapitozzati che mostrano il telaio interno di legno massello. Grande la cura nei dettagli come la chiusura dell'anta tramite magneti e la presa per l'apertura ricavata nel telaio.

Cartalegno is a collection of storage units made up of sideboards and cabinets with a unique, customised design. Its furrowed surfaces are pleasant to the touch, and its clipped corners reveal the internal solid wood frame. The painstaking attention to detail comes through in the door mechanism which uses magnets, and the hand grip carved into the frame.



**DA-DO GIORNO** → P. 061 / 156 / 157 / 184 / 185

Da-Do è un programma giorno composto da Porta TV, Credenze e Madie posizionabili a terra con piedini o piedi in metallo o appesi a parete. Da-Do è altamente personalizzabile grazie all'abbinamento di due finiture, una per l'esterno e una per top e gola che funge da presa per l'apertura. Disponibile inoltre vano a giorno con finitura a contrasto.

Da-Do is a living room range which includes TV units, cabinets and sideboards, which can be free-standing with feet or metal legs, or wall-mounted. Da-Do is highly customisable thanks to the two matching finishes: one for the exterior and one for the top and groove, which acts as a handle grip. An open-fronted compartment with a contrasting finish is also available.

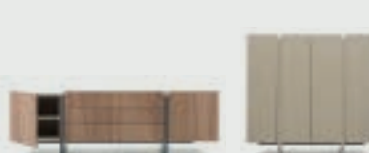

**RECTA** → P. 032 / 033

Recta è disponibile in versione credenza, madia e libreria. Le ante centrali di madie e credenze hanno un'apertura totale a 180°. Ampia la modularità e le conformazioni con la possibilità della laccatura interna.

Recta is available in the sideboard, cabinet and bookcase version. The central doors of the cabinet and sideboard have a total aperture of 180°. Excellent modularity and configuration possibilities, with internal lacquering available.



**RIGADIN** → P. 041 / 042 / 043 / 044 / 045

Il legno massello è l'essenza di Rigadin. Una collezione preziosa e vera, dove la bellezza è forma ma anche sostanza. Pregio ed essenzialità sono plasmati in modo personale, connessi da ispirazione e artigianalità. Disponibile in versione con top metallo o marmo / pietra.

Solid wood is at the heart of Rigadin, an authentic high-value collection. Here, beauty is in the substance, as well as the form. High quality and simplicity are shaped to create a personalised end result, connected through inspiration and craftsmanship. Available with a metal or marble/stone top.

**DOMINO**

Domino è un sistema di contenitori pensili con vani a giorno, ante e cassetti. Disponibili in molte configurazioni posizionabili orizzontalmente o verticalmente crea piacevoli contrasti abbinando differenti finiture tra struttura e frontali.

Domino is a range of wall-mounted storage units with open compartments, doors and drawers. It is available in a host of different configurations, which can be positioned either horizontally or vertically, to create mesmerizing contrasts by matching different finishes in the structure and fronts.

**FREE / POD**

Free è un sistema di schienali con mensoline da appendere a parete. Pod è un contenitore in lamiera studiato per essere un perfetto complemento a questo sistema. Le sue molteplici configurazioni e la possibilità di abbinare differenti finiture tra schienali e mensoline permettono di creare infinite composizioni.

Free is a wall panelling systems with shelves for wall-mounting. Pod is a sheet storage unit devised to be the perfect partner for this system. Its multiple configurations and the ability to combine various finishes for the back panels and shelves make it possible to create endless compositions.

**PRESS**

Press è un porta libri da parete in metallo verniciato con mensoline riposizionabili.

Press is a wall-mounted bookcase in painted metal with movable shelves.

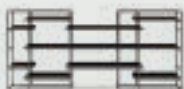
**UP** → P. 078 / 079

Up è una libreria con struttura in metallo verniciato e mensole in varie essenze o laccati. Up è disponibile in tre configurazioni.

The Up bookcase has a painted metal structure and shelves which are available in various wood finishes or lacquer colours. Up is available in three configurations.

**VERSUS**

Versus è un sistema di contenitori pensili con vani a giorno. La possibilità di abbinare differenti finiture tra struttura e interno e il posizionamento orizzontale o verticale danno ampia possibilità di utilizzo.

Versus is a range of wall-mounted storage units with open compartments. The possibility of combining different finishes for both the structure and the interior, along with the horizontal or vertical positioning option means this collection can be used in the most multifarious settings.

**DISCO** → P. 143

La specchiera Disco, adatta ad ogni ambiente, ha cornice in metallo finitura Moka Shine. È disponibile in tre misure.

The mirror Disco, suitable for any space, has a metal frame finished in Moka Shine. The Disco model comes in three sizes.

**ENYA**

Dotata di un bordo in finitura titanio si adatta ad ogni ambiente della casa.

Equipped with an edge in titanium finish, it adapts to any room in the house.

**ESAGONA** → P. 011

La specchiera Esagona, adatta ad ogni ambiente, ha cornice in metallo finitura Moka Shine.

The mirror Esagona, suitable for any space, has a metal frame finished in Moka Shine.

**FIL** → P. 191

Disponibile in una ampia gamma di misure e finiture disponibili per la cornice di forte spessore.

Available in a wide range of sizes and finishes available for the thick frame.

**HAIKU** → P. 069 / 070 / 071

È un sistema semplice per riporre gli abiti velocemente, alloggiare gli accessori che ci accompagnano durante la giornata, mantenere in ordine la stanza da letto. Disponibile nella versione a muro con lo specchio inserito o come semplice oggetto da centro stanza.

Haiku is a simple arrangement for quickly tidying clothes, storing your essential everyday accessories, and keeping your bedroom space clutter-free. Also available in a wall-mounted version with a mirror or as a simple centre piece for your bedroom.

**QUADRATA / RETTANGOLARE**

Specchiere in 2 misure con bordi arrotondati, ideali per piccoli spazi.

Mirrors in 2 sizes with rounded edges, ideal for small spaces.



**ALLEN** → P. 181

Letto imbottito e sfoderabile caratterizzato da una testiera di altezza generosa con piacevole cucitura a motivo esagonale. Ampia la scelta di misure, anche con contenitore.

Padded bed with removable cover and a high headboard featuring hexagonal stitching. There are a wide range of sizes available, including with storage possibilities.



**AREN**

Morbido ma rigoroso allo stesso tempo, Aren si distingue nei particolari, come la cucitura al centro della testiera e le rifiniture laterali con bottoni. Ampia la scelta di misure, anche con contenitore.

Soft yet sleek, Aren features numerous details such as the stitching in the centre of the headboard and buttons on the sides. It is available in a range of sizes, including with storage possibilities.



**DA-DO** → P. 068 / 069 / 221

Completa la collezione Da-Do notte, integrando il gioco grafico dei diversi piani sulla testiera del letto. Il sistema consente l'uso di finiture diverse che giocano insieme legando il giro letto alla testiera. Disponibile anche versione con pannello testiera imbottito e rivestito in tessuto.

This bed completes the Da-Do bedroom collection, adding in a graphic effect with different surfaces on the headboard. Here you can use different finishes that work together, linking the bed frame to the headboard. Also available with a padded, upholstered headboard panel.



**DORIAN**

L'ispirazione è il recupero delle forme retro' dei letti di memoria, dalle linee sottili e dalla struttura quasi evanescente. Ma il tocco di spessori nella finitura della testata, nel disegno delle gambe e nella curvatura elegante di tutti gli elementi, lo rendono un vero pezzo di alto valore, che può essere arricchito da morbidi cuscini per la testata. Ampia la scelta di misure disponibili.

This piece is inspired by and reminiscent of the retro shapes of beds of times past, with thin lines and a structure that almost fades into the distance. The contrasting thickness in the headboard finish, leg design and omnipresent elegant curves make it a high-value piece, which can be embellished with soft headboard cushions. A wide range of sizes are available.



**ASTON**

Aston fa della linearità delle forme la sua carta vincente. Imbottito e sfoderabile è disponibile in un vasta gamma di rivestimenti in tessuto, ecopelle e pelle. Ampia la scelta di misure, anche con contenitore.

Aston's main asset is its linear shape. Padded and with a removable cover, this piece is available in a vast array of fabric and leather upholstery. It comes in a range of sizes, including with storage possibilities.



**CALIFORNIA** → P. 188-189

California è un letto imbottito disponibile in versione sommier o con piedini in metallo. Questo letto può essere arricchito di comode e funzionali testiere alzabili. Ampia la scelta di misure disponibili.

California is a padded bed available as a sofa bed or with metal feet. This bed can be enriched with comfortable, functional headboards that can be raised. A wide range of sizes are available.



**ECATE** → P. 164 / 165 / 166 / 167

Ecate è un confortevole letto caratterizzato da un'esile struttura in legno definita da morbidi raccordi, con la possibilità di personalizzare le gambe a vista. La testiera tessile, essenziale e leggermente curva, dona al letto un fascino ricercato.

Ecate is a comfortable bed, which features a slim wooden frame defined by smooth joints, with the option to customise the legs on view. The fabric headboard, simple and slightly curved, gives the bed refined charm.



**FRANCIS**

Un letto imbottito morbido e rassicurante caratterizzato da una testata avvolgente arricchita da cuciture a vista in contrasto. Due le versioni disponibili, sommier o piattaforma con piedini in metallo, tante le misure, anche con contenitore.

A soft and comforting upholstered bed with an enveloping headboard decorated with visible contrast stitching. It is available in two different versions: either as sofa bed or with a platform and metal feet. It comes in a variety of sizes, including with storage possibilities.



**CLIPPER**

Clipper è un letto con testiera e piattaforma in legno e piedi in metallo. La particolare stondatura degli angoli della piattaforma è ripresa con coerenza nella sagomatura del pannello testiera.

Clipper is a bed with a wooden headboard and platform and metal feet. The unique rounded angles on the platform are echoed in the cut of the headboard panel.



**CLOUD**

I morbidi cuscini imbottiti di questo letto si abbinano perfettamente alla piattaforma con estremità curve e piedini in metallo. Cloud propone un'infinita scelta di abbinamenti tra rivestimenti, essenze e laccati creando soluzioni a misura di ogni ambiente.

The soft, padded cushions on this bed match the platform with curved edges and metal feet perfectly. Cloud is available in many different combinations of upholstery, wood grains and lacquered finishes to create solutions tailored to every space.



**JETTY** → P. 046 / 047

I letti "matrimoniali" con telaio in acciaio nascono dall'idea di una semplice struttura a sbalzo per far sembrare che il letto galleggi sul pavimento. Il pannello della testiera imbottito crea un angolo confortevole con il telaio del letto per essere osato come un poggiaschiena. Testiera in Cuoio, tessuto, pelle o ecopelle e nella versione con giroletto, tessuto abbinato.

The design for this double bed with a steel frame came from the idea of a simple cantilever-style structure, to make the bed seemingly float above the ground. The padded headboard panel creates a comfortable back rest supported by the bed frame. Headboard in leather, fabric or ecoleather; matching upholstery for the model with full bed frame.



**JORDY** → P. 120 / 121

Jordy, un letto che unisce il calore del legno alla morbidezza del tessuto, un perfetto equilibrio di proporzioni e materiali. Un prodotto dalla forte personalità in grado di adattarsi a tantissimi ambienti. La testiera tessile è studiata per adattarsi ai comportamenti delle persone, con un semplice gesto è possibile inclinarla migliorando il comfort e la postura.

Jordy, a bed that brings together the warm feel of wood and the soft comfort of a fabric finish, in a perfect balance of proportions and materials. This bold product adapts to suit a wide range of different spaces. The fabric headboard has been designed to adapt to you and your posture.



### LEONARD

Leonard è un letto imbottito con una testiera fortemente caratterizzata dal motivo capitoné. Disponibile in un'ampia gamma di misure e rivestimenti, anche con contenitore.

Leonard is a padded bed with an upholstered high-impact headboard. It is available in a wide range of sizes and finishes, including with storage possibilities.



### MILANO → P. 056 / 057

Dotato, nella versione pelle, di particolari cuciture "taglio al vivo" che ne delineano i contorni, Milano è un letto imbottito elegante e originale. I morbidi cuscini della testiera si "appoggiano" creando un piacevole gioco di livelli. Ampia la scelta di misure, anche con contenitore.

Featuring unusual, raw-cut stitching in the leather version which decorates the edging, the Milano padded bed is both elegant and original. The soft cushions appear to rest on the headboard, creating the effect of different levels. It is available in a range of sizes, including with storage possibilities.



### SKIP

In assoluta armonia, pannelli in legno o rivestiti creano un gioco assimetrico che da valore visivo alla testata. Con piattaforma legno o imbottita SKIP soddisfa ogni esigenza. Ampia la scelta di misure, anche con contenitore.

Blending together, these wooden or coated panels create an asymmetrical effect which gives the headboard great visual impact. With a wooden platform or padded, SKIP is designed to suit every need. It is available in a range of sizes, including with storage possibilities.



### SUITE SYSTEM

Non solo un letto ma un vero sistema componibile che da ampia scelta di configurazioni e abbinamenti di finiture. Cinque le piattaforme disponibili in abbinamento ai pannelli imbottiti e alle boiserie dotate di pratiche mensole in metallo. Ampia la scelta di misure, anche con contenitore.

It is not just a bed, but a modular creation that allows for a wide range of configurations and combinations of finishes. There are five platforms available, which can be combined with the padded panels and wooden boiserie, fitted with functional metal shelves. It is available in a range of sizes, including with storage possibilities.



### MORRISON → P. 073 / 074 / 237

In questo letto le sezioni laterali leggermente inclinate della testiera portano lo sguardo al morbido rivestimento della parte centrale. Morrison dà libera scelta all'abbinamento tra il sommier o la piattaforma con piedini in metallo. Ampia la scelta di misure, anche con contenitore.

The slightly arched sides of the headboard on this bed lead the eye towards the soft upholstery of the central part. Morrison can be combined freely as a sofa bed or with a platform and metal feet. It is available in a range of sizes, including with storage possibilities.



### NEYÓ → P. 020 / 021 / 022 / 023

Il disegno morbido che definisce sia gli elementi imbottiti sia i doppi ripiani regala alla composizione l'aria avvolgente e funzionale di un letto a cui non servono altri complementi. Il letto può essere rivestito con tutti i tessuti e le pelli disponibili in catalogo, i ripiani laterali sono proposti in Fashion wood, roveri laccati opachi o marmo di Carrara.

The soft design of both the padded elements and the double shelf adds a welcoming, functional air to the composition. This bed needs no further complements. It can be upholstered in all the fabrics and leathers available in the catalogue, while the side shelves are available in Fashion Wood, matt lacquered oak or Carrara marble.



### TEO → P. 204 / 205

Teo è un letto con struttura in legno dalle forme essenziali e moderne disponibile con tre varianti di piattaforma. Il pannello testiera può essere "vestito" da un cappuccio imbottito e trapuntato disponibile in tutti i rivestimenti a campionario. Dispone inoltre di una versione con contenitore.

Teo is a bed featuring a minimalist, modern wooden frame available with three different platform models. The headboard panel can be dressed with a padded, quilted hood, available in all sample box upholstery options. A version with a storage unit is also available.



### XILO → P. 098 / 099 / 152 / 153

Xilo è un letto con struttura in legno curvato e piedi in metallo. Si distingue per la stonatura ai lati della testiera e per le forme decise ma leggere della piattaforma. La possibilità della testiera rivestita in cuoio ne amplia le possibilità.

Xilo is a bed with a curved wooden structure and metal feet. It features rounded sides on the headboard and a bold but light platform. The headboard can also be upholstered in leather, making it even more adaptable.



### OREGON

Oregon è un letto caratterizzato dalla particolare sagoma della testiera su due livelli che "abbraccia" la piattaforma. Una vasta scelta di misure e la possibilità del contenitore completano l'offerta di questo prodotto.

Oregon features an originally shaped headboard on two levels, which folds in to embrace the platform. This product is available in a vast range of sizes and a storage unit can be added.



### RALPH

Linee intramontabili per il letto imbottito che stupisce nei particolari con diverse cuciture disponibili. Ampia gamma di misure disponibili, anche con contenitore.

The eternal shape of this padded bed is combined with unexpected detailing in the form of the available stitching options. It comes in a wide range of sizes, including with storage possibilities.



**ADJ**

Le linee curve danno grande carattere a questo gruppo letto che si distingue anche per l'originale taglio inclinato della parte superiore. In questo modo il top diventa anche un pratico portaoggetti delimitato dalle linee del mobile stesso.

The curved lines add real character to this bed composition, which also features an original slanted angle on top. This turns the top into an extra practical storage and display surface, framed by the structure of the unit itself.



**DA-DO SYSTEM** → P. 068 / 069 / 073 / 075 / 221

Da-Do è un gruppo letto componibile caratterizzato dalla grande modularità e versatilità. Rigoroso e lineare può abbinare due finiture, una per l'esterno e una per top e gola che funge da presa per l'apertura. Semplicemente sovrapponendo i moduli o fissandoli a parete, Da-Do offre infinite possibilità compositive per sfruttare al meglio lo spazio e personalizzare in modo unico l'ambiente notte.

Da-Do is a highly versatile, modular bed unit. Its clean, linear look features two finishes, one for the exterior and one for the top and groove, which also serves as a handle grip. By stacking or mounting the units on the wall, Da-Do offers an infinite number of possible compositions to make the best use of your space and personalise the bedroom in a truly unique way.



**RIM**

Rim è un comodino con anta o vano a giorno, di differenza per la linea curva e le dimensioni compatte. La possibilità del bicolore ne esalta le linee e ne amplia la versatilità.

Rim is a night stand with either a door or open compartment. It stands out for its curved lines and compact size. The two-tone option brings out its shape and makes it a truly versatile piece.



**SEGNO**

Un top in forte spessore alternato ad un sistema di gole sottili crea un grafismo che permette anche un gioco di colori.

The thick-top and thin-grooves combination creates a visual effect that also plays with colour.



**FIL** → P. 109 / 188 / 189 / 190 / 191

Si distingue per la linea filante e minimale. Fil è un gruppo letto componibile con una vasta modularità. Può avere due versioni di piedi o essere appeso a parete, creando ampie possibilità compositive. Si caratterizza inoltre per la scelta nell'apertura tra la piccola maniglia in metallo in posizione asimmetrica o il push-pull.

This piece is characterised by its sleek, minimalist lines. Fil is a modular bed unit which can be used in a wide array of compositions. There are two floor-standing options and it can be wall mounted. There are also two ways to open the units, either using the small, asymmetric metal handle or the push-pull mechanism.



**HOBBY** → P. 180 / 181

Un gruppo che unisce un design minimale e un'eleganza rigorosa, caratterizzato da elementi ricercati, come il basamento in metallo e le originali maniglie.

This storage unit that combines minimalist design with pure elegance, distinguished by sophisticated details such as the metal base and original small handles.



**TIMELESS** → P. 098 / 152 / 153

Timeless è un gruppo letto dal disegno sempre attuale con stondatura e sagomatura dei fianchi e maniglia in metallo. Disponibile in variante comodino comò e settimanale in diverse misure.

Timeless is an on-trend bedroom suite with shaped and rounded sides and a metal handle. Available as a bedside table, dresser and chest of drawers in various sizes.



**TWICE**

Comodini, comò e settimanale lineari e ben proporzionati sfruttano una "catena" come presa per una agevole apertura. Tale rientranza caratterizza ulteriormente il mobile nella versione con finitura in contrasto.

These bedside tables, dressers and chests of drawers with well-proportioned, linear lines feature a "chain" groove that provides for easy opening. This recess is particularly characteristic in the models featuring a contrasting colour.



**LINEA**

Programma di contenitori che posizionati a terra, appesi o sovrapposti creano soluzioni piacevoli e contenitive. Abbinabile a piccole librerie che arricchiscono il programma dando sfogo a svariate interpretazioni.

This collection of storage units creates pleasant floor-standing, suspended or stacked storage solutions. They can also be teamed with small bookcases to enrich the collection and give free rein to a multitude of interpretations.



**OLIS** → 056 / 057 / 164 / 165 / 166 / 167 / 236 / 237

Gruppo notte composto da comò e comodino caratterizzati da linee curve. È previsto in tutte le finiture laccate e i legni fashion wood.

A bedroom collection made up of dressers and bedside tables featuring curved lines. It is available in all the lacquered and Fashion Wood finishes.



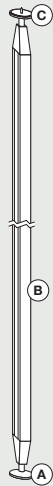
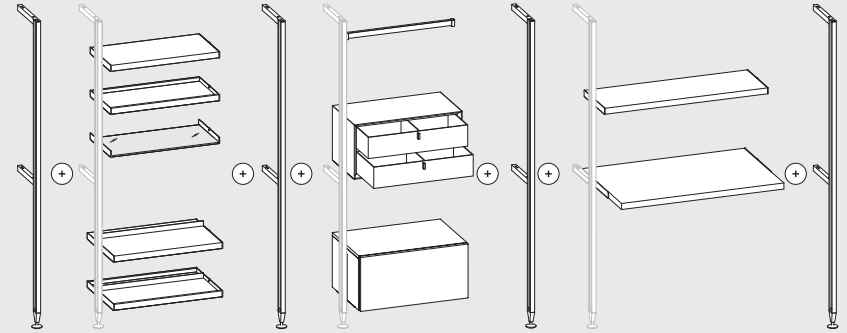

**Montante a soffitto / Bifacciale**  
Ceiling upright / Double-sided



**Sezione montante a soffitto / Bifacciale**  
Cross-section of ceiling upright / Double-sided

**A / Piede a terra Ø 5,7 cm.**  
N.B. permette la regolazione in altezza di 1 cm.  
Foot (floor) Ø 5.7 cm.  
N.B. adjust the unit height by 1 cm.  
**B / profilo per montante a soffitto in estruso di alluminio verniciato.**  
Coated extruded aluminium profile for ceiling upright.  
**C / piede a soffitto Ø 5,7 cm.**  
N.B. permette la regolazione in altezza di 1 cm.  
Foot (ceiling) Ø 5.7 cm.  
N.B. adjust the unit height by 1 cm.

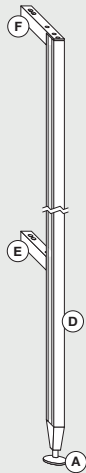

**Montante a parete**  
Wall upright



**Sezione montante a parete**  
Cross-section of wall upright

**A / Piede a terra Ø 5,7 cm.**  
N.B. permette la regolazione in altezza di 1 cm.  
Foot (floor) Ø 5.7 cm.  
N.B. adjust the unit height by 1 cm.  
**D / Profilo per montante a parete in estruso di alluminio verniciato.**  
Coated extruded aluminium profile for wall upright.  
**E / traverso centrale in estruso di alluminio verniciato (sempre presente a prescindere dall'altezza).**  
Coated extruded aluminium central crosspiece (always required irrespective of the unit height).  
**F / Traverso superiore in estruso di alluminio verniciato.**  
Coated extruded aluminium top crosspiece.

**Mensola legno sp. 3,5 cm con staffe in metallo verniciato moka shine.**  
/ Wooden shelf 3.5 thick with moka shine painted metal brackets.

**Mensola legno sp. 1,4 cm in folding con staffe in metallo verniciato moka shine.**  
/ Folded wooden shelf 1.4 thick with moka shine painted metal brackets.

**Mensola in vetro trasparente grigio con staffe in metallo verniciato moka shine.**  
/ Grigio transparent glass shelf with moka shine painted metal brackets.

**Mensola portascarpe Sp. 3,5 cm con staffe in metallo verniciato moka shine.**  
/ Shoe rack shelf 3.5 thick with moka shine painted metal brackets.

**Mensola portascarpe Sp. 1,4 cm in folding con staffe in metallo verniciato moka shine.**  
/ Folded shoe rack shelf 1.4 thick with moka shine painted metal brackets.

**Tubo appendiabiti.**  
/ Clothes rail.

**Scrivania legno sp. 3,5 cm con staffe in metallo verniciato moka shine.**  
/ Wooden desk 3.5 thick with moka shine painted metal brackets.

**Contenitore VAS con staffe in metallo verniciato moka shine.**  
/ VAS storage unit with moka shine painted metal brackets.

**Box interno per contenitore VAS.**  
/ Internal box for VAS storage unit.

**Contenitore finito cm con staffe in metallo verniciato moka shine.**  
/ Finished storage unit with moka shine painted metal brackets.

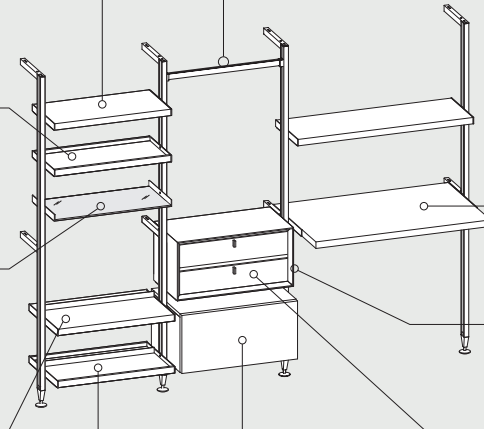



**PENSILI SPECIALI /  
SPECIAL WALL UNITS**

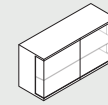

**Pensili Ghost**  
/ Ghost wall units

**FREE / POD / DOMINO / VERSUS**

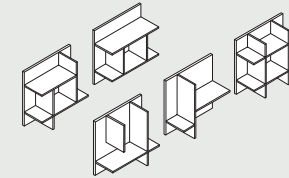

**Free / Pod**

**SCHIENALI / WALL PANELS**

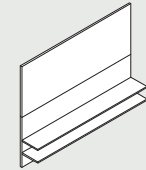

**Schienali**  
/ Wall panels

**BASI / BASE UNITS**



**Vani a giorno**  
/ Open units

**CONTENITORI SPECIALI /  
SPECIAL UNITS**

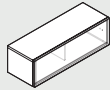

**Contenitori Grid**  
/ Grid units

**PENSILI / WALL UNITS**

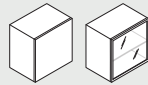

**Pensili con ante**  
/ Wall units with doors

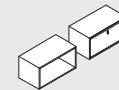

**Pensili Cube**  
/ Cube wall units

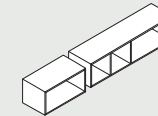

**Domino**

**PANCHE, MENSOLE /  
BENCHES, SHELVES**

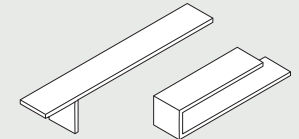

**Panche - Mensole**  
/ Benches - Shelves

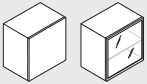

**Basi con ante**  
/ Base units with doors

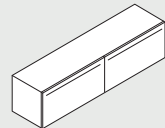

**Contenitori con ante complanari**  
/ Storage units with coplanar doors

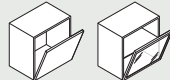

**Pensili con ante ribalta**  
/ Wall units with flap doors

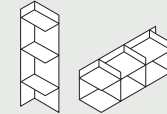

**Pensili metallo Plate**  
/ Plate metal wall units

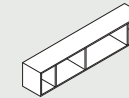

**Versus**

**CREDENZE DIKO /  
DIKO SIDEBOARD**

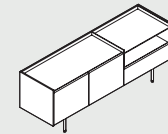

**Diko**

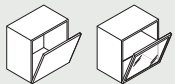

**Basi con ante ribalta**  
/ Base units with flap doors

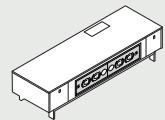

**Soundbox**

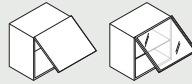

**Pensili con ante vasistas**  
/ Wall units with tilt doors

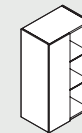

**Pensili Show**  
/ Show wall units

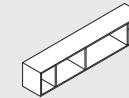

**PIANALI A "C" /  
C-SHAPED FRAME**

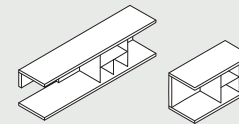

**Pianali a "C"**  
/ C-shaped frame

**SCRITTOI /  
DESKS**

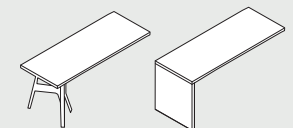

**Scrittoi**  
/ Desks



**Basi con cassetti, cesti e cestoni**  
/ Base units with drawers or large drawers



**Pensili Wing**  
/ Wing wall units



**SALA DA PRANZO**  
Composizione con divisori Book e ante Teca  
**DINING ROOM**  
Composition with "Book" partitions and Teca doors



**SALOTTO** Composizione porta TV e composizione con ante  
**LIVING ROOM**  
Composition with TV stand and composition with doors



**INGRESSO/STUDIO**  
Composizione con pensili Expo e scrittoio  
**HALL/STUDIO**  
Composition with Expo wall units and desk



**SALA DA PRANZO**  
Composizioni con ante Teca  
**DINING ROOM**  
Composition with Teca doors



**SALOTTO** Composizione con ante scorrevoli  
**LIVING ROOM**  
Composition with sliding doors



**RECEPTION**  
Composizione con pensili Expo e ante  
**RECEPTION** Composition with Expo wall units and doors

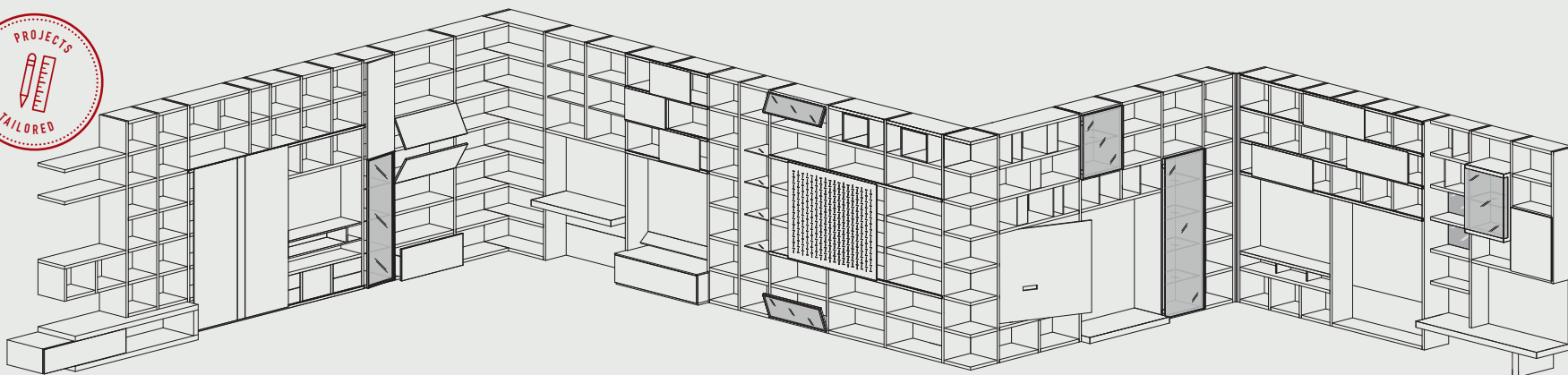

**STUDIO** Composizione con Tavolo Aliante, pensili e pensile Ghost  
**STUDY** Composition with Aliante table, wall units and Ghost wall unit



**BAGNO** Composizione bifacciale con elementi Regolo  
**BATHROOM** Two-face composition with Regolo units



**INGRESSO** Composizione con elementi Regolo e ante  
**HALL** Composition with Regolo units and doors



**SALA MASSAGGI**  
Composizione con ripiani  
**MASSAGE ROOM**  
Composition with shelves



**STOCCAGGIO**  
Composizione isola cassetti esterna (vedi Mixer armadi)  
**STORAGE** Island composition with external drawers (see Mixer wardrobes)



**POSTAZIONE SINGOLA**  
Composizione con tavolo Aliante  
**SINGLE WORKSTATIONS**  
Compositions with an Aliante table

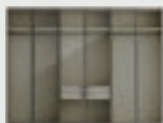

**DISPLAY**  
Apertura battente /  
Swinging opening



**RAIN**  
Apertura battente /  
Swinging opening



**SLIVER**  
Apertura battente /  
Swinging opening



**SIMPLE**  
Apertura battente /  
Swinging opening



**DISPLAY**  
Apertura scorrevole /  
Sliding opening



**GLIDE**  
Apertura scorrevole /  
Sliding opening



**FRAME**  
Apertura scorrevole /  
Sliding opening



**QUADRA**  
Apertura scorrevole /  
Sliding opening



**SPLIT**  
Apertura battente /  
Swinging opening



**STRIP**  
Apertura battente /  
Swinging opening



**RAIN**  
Apertura scorrevole /  
Sliding opening



**RUBIC**  
Apertura scorrevole /  
Sliding opening



**SIMPLE**  
Apertura scorrevole /  
Sliding opening



**SPLIT**  
Apertura scorrevole /  
Sliding opening



**STRIP**  
Apertura scorrevole /  
Sliding opening



**VISION**  
Apertura scorrevole /  
Sliding opening



**GLIDE**  
Apertura coplanare /  
Coplanar opening





Vassoio in alluminio grigio fumo con fondo in finitura H 5 cm  
Grigio fumo aluminium tray with finished bottom H. 5 cm

Vassoio in alluminio grigio fumo con fondo in finitura H 11 cm  
/Grigio Fumo aluminium tray with finished bottom H. 11 cm

FINITURE / FINISHES

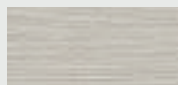

Decor Tortora  
/Tortora Decor

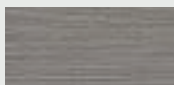

Decor Arena  
/Arena Decor

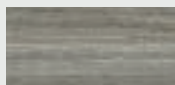

Eukalipto Cenere  
/Eukalipto Cenere

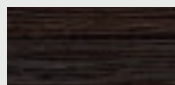

Rovere Bruno  
/Bruno oak



Decor laccati opachi  
/Matt lacquered Decor

Scatole portaoggetti rivestite in tessuto H 5 cm  
/Fabric-covered storage boxes H. 5 cm



20

10

Scatole portaoggetti per cassetto rivestite in tessuto  
/Fabric-covered storage boxes for drawers



Scatole portaoggetti per vassoio estraibile rivestite in tessuto  
/Fabric-covered storage boxes for pull-out trays



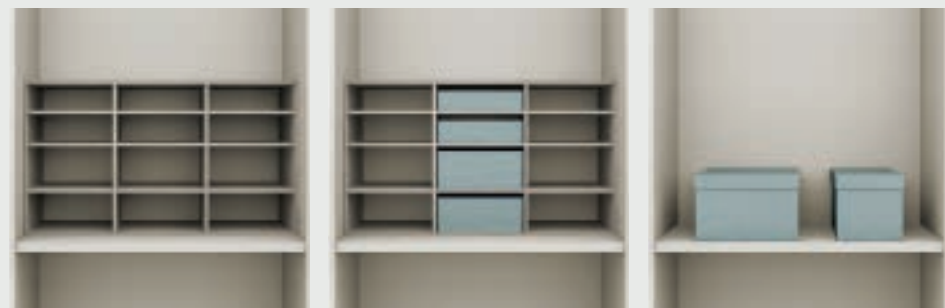

Raster  
/Cubby-hole unit

Raster con scatole rivestite in tessuto  
/Cubby-hole unit with fabric-covered boxes

Scatole con coperchio rivestite in tessuto  
/Fabric-covered boxes with lid

\* Le scatole rivestite in tessuto nei Raster possono essere posizionate solo nei vani centrali  
/The fabric-covered boxes in the cubby-hole units can only be used in the central compartments



Isola cassetti esterna L 110,7 cm  
/External drawer-unit island W 110.7 cm

Isola cassetti esterna L 146,9 cm  
/External drawer-unit island W 146.9 cm



Isola cassetti esterna L 186,9 cm  
/External drawer-unit island W 186.9 cm

Le isole cassetti esterne sono formate da:  
1 vassoio basso con frontale vetro trasparente grigio H 12,4 cm  
1 vassoio alto con frontale vetro trasparente grigio H 18,8 cm  
2 cassetti alto con frontale legno H 18,8 cm  
maniglie finitura Moka shine, retro a giorno  
/The external drawer-unit islands are composed of:  
1 shallow tray with Grigio transparent glass front, H. 12.4 cm  
1 deep tray with Grigio transparent glass front, H. 18.8 cm  
2 deep drawers with wood front H. 18.8 cm  
handles in Moka Shine finish, open back

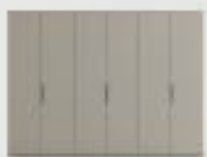

**EVEN**  
Apertura battente /  
Swinging opening



**GO**  
Apertura battente /  
Swinging opening



**GO UP**  
Apertura battente /  
Swinging opening



**GO UP**  
Apertura scorrevole /  
Sliding opening



**CLARA**  
Apertura scorrevole /  
Sliding opening



**CONTOUR**  
Apertura scorrevole /  
Sliding opening



**EVEN**  
Apertura scorrevole /  
Sliding opening





1 INGRESSO CORRIDOIO  
ENTRANCE HALL CORRIDOR



2 CORRIDOIO  
CORRIDOR



3 CAMERA  
BEDROOM



4 CABINA ARMADIO  
WALK-IN WARDROBE



5 LAVANDERIA  
LAUNDRY ROOM



6 INGRESSO/SOGGIORNO  
ENTRANCE HALL/LIVING ROOM

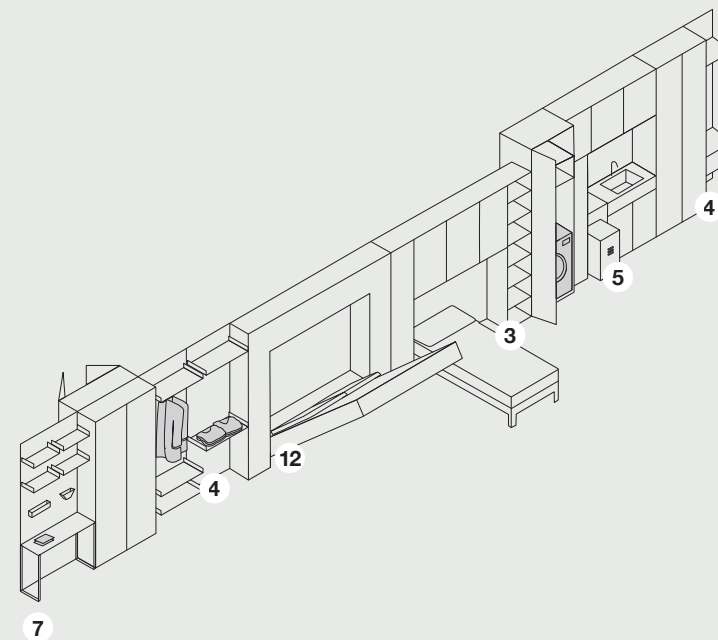
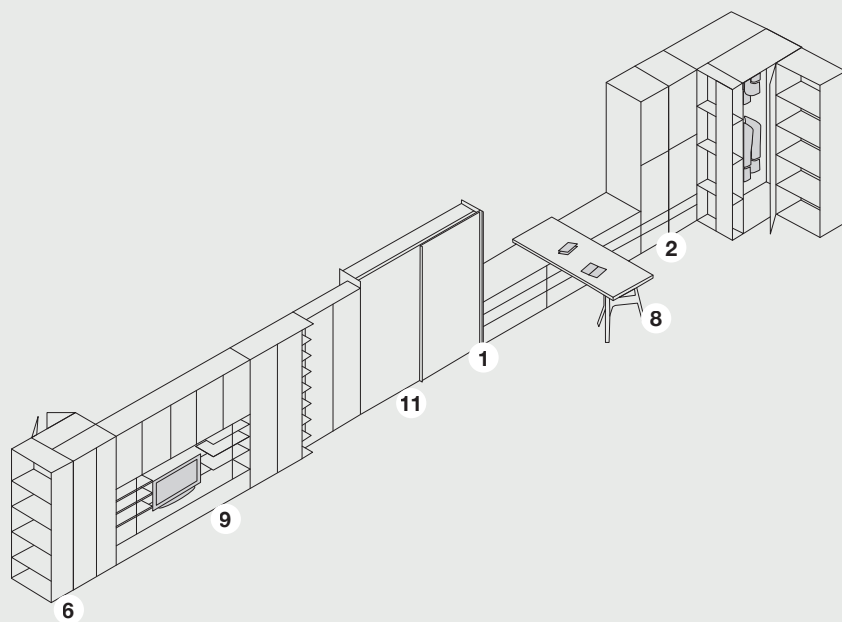

7 STUDIO  
STUDY



8 CAMERETTA  
CHILDREN'S BEDROOM



9 SOGGIORNO  
LIVING ROOM



10 SOTTOTETTO  
ATTIC



11 BAGNO  
BATHROOM



12 STANZA OSPITI  
GUEST ROOM





**CONFIGURAZIONI DI ANTE E CASSETTI ESTERNI CON GOLA**

/configurations of doors and external drawers with groove /configuraciones de puertas y cajones exteriores con ranura /configurations de portes et de tiroirs extérieurs avec gorge /Ausführung der Türen und Schubladen außen mit Kehlleiste /конфигурации створок и внешних ящиков с пазом

**CONFIGURAZIONI DI ANTE E CASSETTI ESTERNI**

/configurations of doors and external drawers / configuraciones de puertas y cajones exteriores /configurations de portes et de tiroirs extérieurs /Ausführung der Türen und Schubladen außen /конфигурации створок и внешних ящиков

**CONFIGURAZIONI DI ANTE E CASSETTI ESTERNI CON GOLA**

/configurations of doors and external drawers with groove /configuraciones de puertas y cajones exteriores con ranura /configurations de portes et de tiroirs extérieurs avec gorge /Ausführung der Türen und Schubladen außen mit Kehlleiste /конфигурации створок и внешних ящиков с пазом

**APERTURE ANTE E CASSETTI**

/door and drawer opening systems /aperturas de puertas y cajones /ouvertures des portes et des tiroirs / Öffnungen Türen und Schubladen /системы открытия створок и ящиков

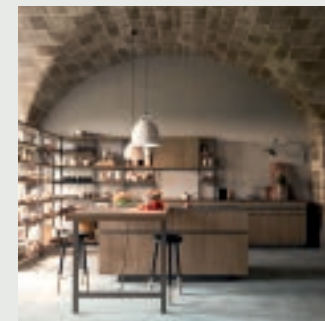
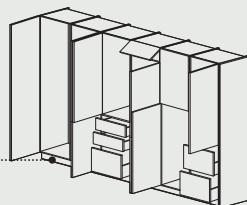
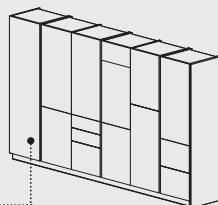
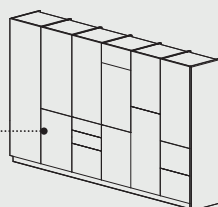
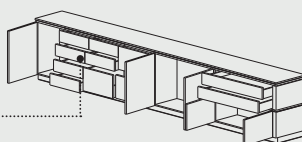
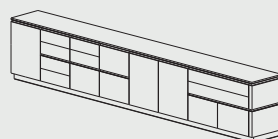
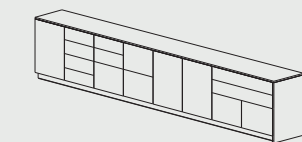

**CONFIGURAZIONI DI FIANCHI PER GOLA LATERALE**

/configurations of side panels for side groove /configuraciones de costados para ranura lateral /configurations de côtés pour gorge latérale /Ausführungen der Außenseiten für Kehlleiste an der Seitenteile /конфигурации боковин для бокового паза

**APERTURE ANTE E CASSETTI**

/door and drawer opening systems /aperturas de puertas y cajones /ouvertures des portes et des tiroirs /Öffnungen Türen und Schubladen /системы открытия створок и ящиков

**DISPENSA SCAFFALE ATTREZZABILE**

/Accessorised Larder Shelving Unit /Estantería despensa equipable /Desserte Étagère pouvant être équipée /Vorratsregal mit Zubehör /Оснащаемый шкаф

**CONFIGURAZIONI DI ANTE E CASSETTI ESTERNI CON GOLA**

/configurations of doors and external drawers with groove /configuraciones de puertas y cajones exteriores con ranura /configurations de portes et de tiroirs extérieurs avec gorge /Ausführung der Türen und Schubladen außen mit Kehlleiste /конфигурации створок и внешних ящиков с пазом

**COLONNE FULL-ACCESS**

/full-access tall units /columnas full-access /colonnes full-access /Hochschränke Full-Access /колонны full-access

**ANTE RIENTRANTI**

/Retractable doors /Puertas escamoteables / Portes rentrantes / Versenkbare Türen /Убирающиеся створки

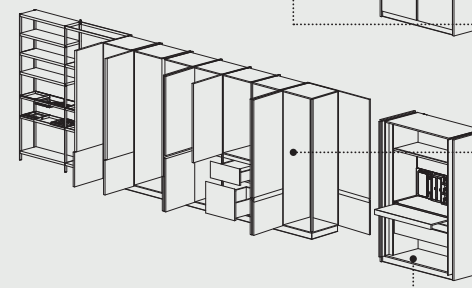
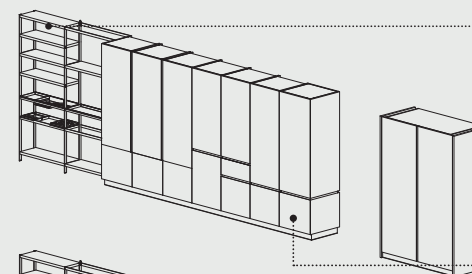
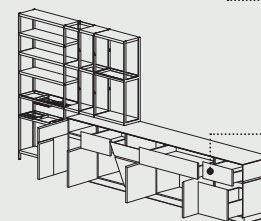
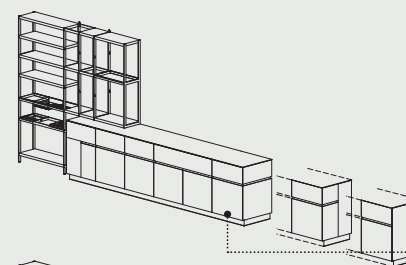



**CONFIGURAZIONI DI ANTE E CASSETTI ESTERNI**

/configurations of doors and external drawers / configuraciones de puertas y cajones exteriores / configurations de portes et de tiroirs extérieurs / Ausführung der Türen und Schubladen außen / конфигурации створок и внешних ящиков

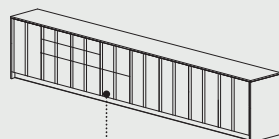

**APERTURE ANTE E CASSETTI**

/door and drawer opening systems /aperturas de puertas y cajones /ouvertures des portes et des tiroirs / Öffnungen Türen und Schubladen /системы открытия створок и ящиков

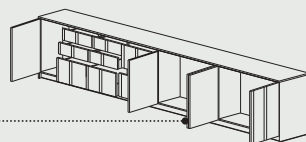

**CONFIGURAZIONI DI ANTE E CASSETTI ESTERNI**

/configurations of doors and external drawers / configuraciones de puertas y cajones exteriores / configurations de portes et de tiroirs extérieurs / Ausführung der Türen und Schubladen außen / конфигурации створок и внешних ящиков

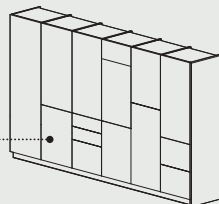

**APERTURE ANTE E CASSETTI**

/door and drawer opening systems /aperturas de puertas y cajones /ouvertures des portes et des tiroirs / Öffnungen Türen und Schubladen /системы открытия створок и ящиков

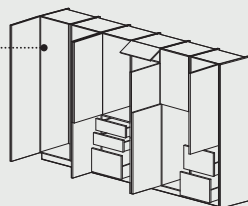

# ITALIER

