

Store / Antis

cabine armadio / walk-in wardrobes



Alf DaFrè®

world wide offices

CANADA & USA NORTH-EAST COAST
TEL. (416) 663-2223 - FAX (416) 663-2594
E-MAIL: alf@rosnerinternational.com

CENTRAL AMERICA - CARIBBEAN ISLANDS
TEL. (787) 786-9705 - FAX (787) 785-9835
E-MAIL: alvin@arodz.net

LOUISIANA-OKLAHOMA-TEXAS
TEL. (405) 204-4737
E-MAIL: parke@furnituresourcetexas.com

ARIZONA-OREGON-WASHINGTON-NORTHERN CALIFORNIA-ALASKA-COLORADO-UTAH-NEW MEXICO-HAWAII
TEL. (707) 291 2995
E-MAIL: corneliusssen@aol.com

FLORIDA - ALABAMA
TEL. (321) 773-6982 - FAX (321) 773-8324
E-MAIL: lloydavisiii@aol.com

MID-WEST/SOUTH-EAST (EXCLUDING FLORIDA)
TEL. (310) 636-1199 - FAX (310) 636-4433
E-MAIL: bill@weisbergsales.com

U.S.A.: HIGH POINT SHOWROOM
(OPEN ONLY DURING FURNITURE MARKET DATES)
TEL. (336) 889-9027

NEVADA-SOUTHERN CALIFORNIA
E-MAIL: alf@alf.it

AUSTRALIA & NEW ZEALAND
TEL. (08) 9314 3999 - FAX (08) 9314 3777
E-MAIL: ross@merlino.com.au

MEXICO
TEL. (55) 5351-1348
E-MAIL: furnituzenteno@yahoo.com

AUSTRIA
TEL. +43(0)4240 20358 - FAX +43(0)4240 20370
E-MAIL: luca.zoldan@designphilosophy.org

GERMANY
TEL. +49 171 8043908
E-MAIL: roberto.sonego65@gmail.com

SWITZERLAND
TEL. +39 342 776 0752
E-MAIL: d.pagot@agentur2020.com

DENMARK
TEL. +45 20475875
E-MAIL: lehri@mail.dk

BELGIUM - LUXEMBOURG
TEL. +32 471726845
E-MAIL: jan@jmsa.be

NETHERLANDS
TEL. +31-655-191753
E-MAIL: arnold@hakse.com

EAST EUROPE
TEL. +39 3484064921
E-MAIL: caputomauro@libero.it

ICELAND
TEL. +354 5880640
E-MAIL: casa@casa.is

U.K. - IRELAND
TEL. + 44 7980019194
E-MAIL: design@atmosphere1102.com

FRANCE - BRETAGNE - NORMANDIE - CENTRE
TEL. 0033608423974
E-MAIL: contact@jmcsarl.fr

FRANCE - EST
TEL. 0033615436985
E-MAIL: ch.vidrin@wanadoo.fr

FRANCE - SUD-EST
TEL. 06 33 83 87 58
E-MAIL: fd.developpement@orange.fr

FRANCE - ILE DE FRANCE - NORD
TEL. 06 60 65 61 62
E-MAIL: decaix.christophe@wanadoo.fr

FRANCE - SUD-OUEST
TEL. 06 40 55 21 88
E-MAIL: tgirerd.gtb@gmail.com

FRANCE - RHONE/ALPES
TEL. 0033689923725 - FAX 0033466777294
E-MAIL: frederic.ac@orange.fr

HELLAS-CYPRUS
TEL. +39 0434 77199 - FAX +39 0434 779591
E-MAIL: luca.zoldan@designphilosophy.org

INDIA-SRI LANKA
TEL. +91 8041285290 - 91 9845636644
E-MAIL: keith@kreb.in

ALF GROUP MIDDLE-EAST REP. OFFICE
TEL. +961 4718160 - FAX +961 4718159
E-MAIL: info@alfme.com

POLAND
TEL. +48 618175994 - FAX +48 616429218
E-MAIL: karina@qualitaitaliana.pl

CSI E PAESI BALTICI
TEL. +7-812-3322934 - FAX +7-812-3322934
E-MAIL: office.spb@alf.it

ALGERIA - TUNISIA
E-MAIL: info@wallitaliandesign.it

SOUTH AFRICA
TEL. +27 0861777123 - FAX +27 0118262186
E-MAIL: les@alfsa.co.za

SPAIN - ANDALUCIA Y EXTREMADURA
TEL. +34 958818744 - FAX +34 935531590
E-MAIL: info@javiercastellon.com

SPAIN - CASTILLA Y LEON
TEL. +34983541003 - FAX +34983541003
E-MAIL: evaristorg@gmail.com

SPAIN - BARCELONA - CATALUNYA Y ANDORRA
TEL. +34 935531590 - FAX +34 935531590
E-MAIL: albert-miro-mauri@hotmail.com

SPAIN - VALENCIA, MURCIA Y CASTILLA LA MANCHA
TEL. +34 607 210 185
E-MAIL: jlhervas.vlc@gmail.com

SPAIN - MADRID
TEL. +34 607 363 016 - FAX +34 91 351 57 27
E-MAIL: e.sesenna@telefonica.net

SPAIN - SORIA, LA RIOJA, MALLORCA, MENORCA, IBIZA, FORMENTERA Y ASTURIAS
E-MAIL: alf@alf.it

SPAIN - ARAGÒN
TEL. +34 650236594 - FAX +34 976598600
E-MAIL: davidmirandamoreno@gmail.com

SPAIN - PAIS VASCO, LA RIOJA, NAVARRA Y CANTABRIA
TEL. +34 656 703 204
E-MAIL: iruoffice@iruoffice.com

PORTUGAL
TEL. +351 919 723 837
E-MAIL: alice.barroso@mail.telepac.pt

TURKEY
E-MAIL: alf@alf.it

INDONESIA - SINGAPORE
TEL. +65 91214415
E-MAIL: alberto.fantin@soluzioni.com.sg

TAIWAN - COREA DEL SUD - GIAPPONE
TEL. 0082 1086862707
E-MAIL: mattiazanini.alfitalia@gmail.com

Alf DaFre®

ALF UNO Spa
Via S. Pio X 17
31018 Francenigo di Gaiarine
Treviso, Italy
Tel. +39 0438 997111
Fax Italia +39 0438 997245
Fax estero +39 0438 997246
www.alfdafre.it alf@alf.it



ALF UNO Spa
è certificata **ISO 9001:2015**
ALF UNO Spa
is certified by the **ISO 9001:2015**

Alf DaFre®

STORE

è una cabina armadio componibile
composta da schienali attrezzabili.
Offre grandi varietà compositive grazie
all'ampia gamma di accessori disponibili.



STORE is a modular walk-in wardrobe made up of back panels that can be accessorised. It offers excellent variety for your composition, thanks to a wide range of available accessories.

STORE es un armario vestidor modular formado por paneles de pared equipables. Ofrece una gran variedad compositiva gracias a la amplia gama de accesorios disponibles.

STORE est une cabine armoire modulable composée de panneaux arrière pouvant être équipés. Elle offre de grande possibilité de composition grâce à l'ample gamme d'accessoires disponibles.

STORE ist ein modulares System für begehbare Kleiderschränke, das aus ausstattbaren Rückwänden besteht. Dank der umfassenden Auswahl an Zubehör bietet es große gestalterische Freiheit.

STORE представляет собой компонуюемую гардеробную с оснащаемыми задними стенками. Предлагает большие композиционные возможности благодаря широкой гамме имеющихся аксессуаров.

ANTIS

è un sistema composto da "montanti"
attrezzabili caratterizzato dalla libertà di
scelta in altezza e di posizione degli elementi
con la possibilità di creare molteplici
configurazioni.

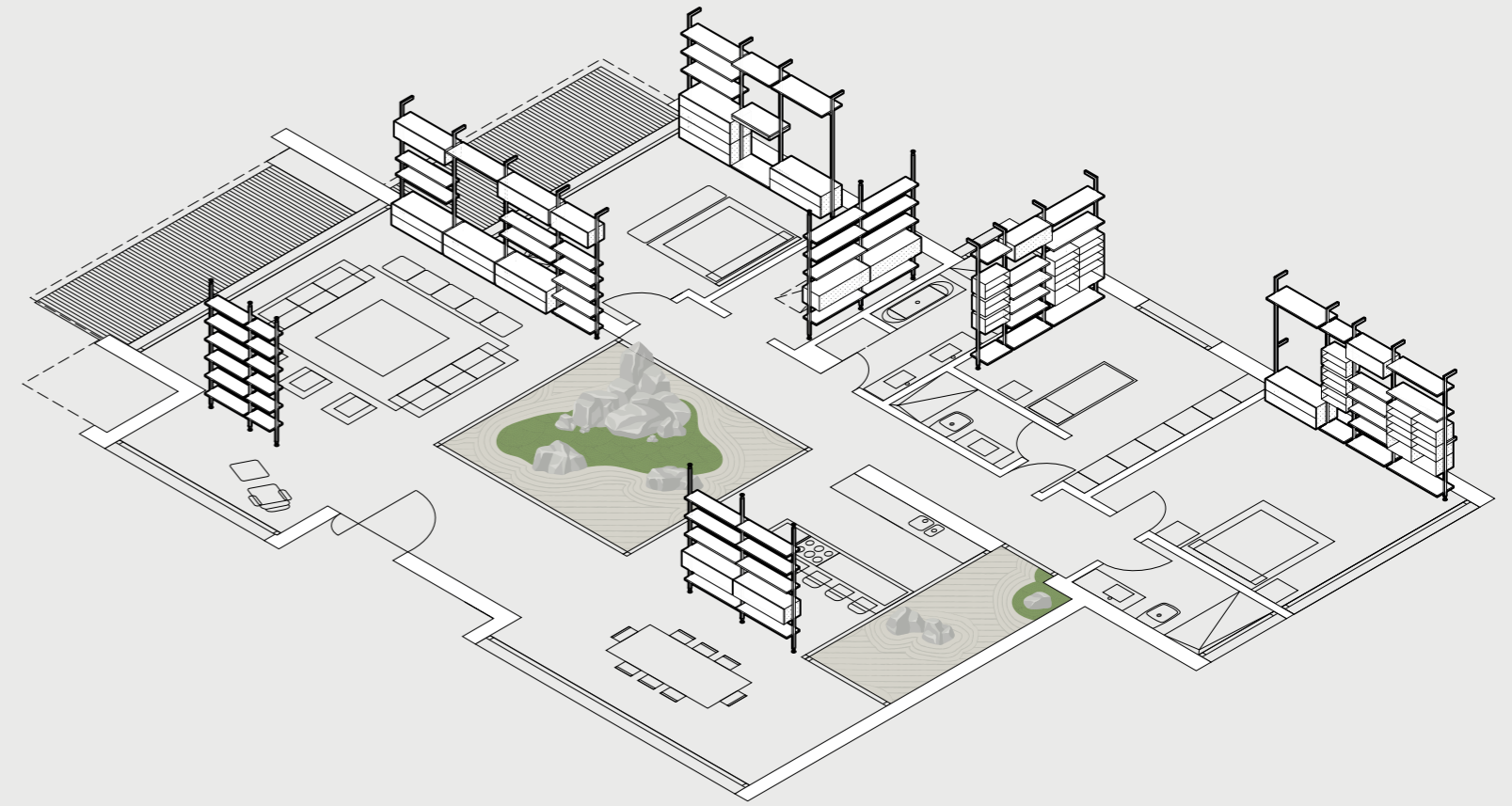

ANTIS is a system of "uprights" you can accessorise and build freely. You choose the height and position of the different elements to create infinite configurations.

ANTIS es un sistema formado por "montantes" equipables caracterizado por la posibilidad de elegir libremente la altura y la posición de los elementos, permitiendo crear diversas configuraciones.

ANTIS est un système composé de « montants » pouvant être équipés, caractérisé par la liberté de choix en hauteur et de position des éléments avec la possibilité de créer de multiples configurations.

ANTIS ist ein System, das aus ausstattbaren Montageleisten besteht. Es zeichnet sich besonders durch seine außergewöhnliche Flexibilität bei der Wahl der Höhe und der Position der Elemente sowie seine zahlreichen Kombinationsmöglichkeiten aus.

ANTIS - система из оснащаемых «стоек», характеризующаяся свободой выбора высоты и положения элементов с возможностью создания многочисленных конфигураций.



STORE
è una cabina armadio componibile
composta da schienali attrezzabili.
Offre grandi varietà compositive grazie
all'ampia gamma di accessori disponibili.

STORE is a modular walk-in wardrobe made up of back panels that can be accessorised. It offers excellent variety for your composition, thanks to a wide range of available accessories.

STORE es un armario vestidor modular formado por paneles de pared equipables. Ofrece una gran variedad compositiva gracias a la amplia gama de accesorios disponibles.

STORE est une cabine armoire modulable composée de panneaux arrière pouvant être équipés. Elle offre de grande possibilité de composition grâce à l'ample gamme d'accessoires disponibles.

STORE ist ein modulares System für begehbare Kleiderschränke, das aus ausstattbaren Rückwänden besteht. Dank der umfassenden Auswahl an Zubehör bietet es große gestalterische Freiheit.

STORE представляет собой компоную гардеробную с оснащаемыми задними стенками. Предлагает большие композиционные возможности благодаря широкой гамме имеющихся аксессуаров.



finiture / finishes
Nobilitato Rovere bruno / Bruno oak surfaced
Nobilitato Piasentina / Piasentina surfaced
Laccato opaco Nude e Pacifico / Matt Nude and Pacifico lacquer



L298,4 X 426 P59,6 H277

→ IT

Schienali Nobilitato Piasentina, Nobilitato rovere Bruno
Ripiani Laccato opaco Nude, Nobilitato rovere Bruno, Laccato opaco Pacifico,
Cassettiere Nobilitato rovere Bruno, Vetro trasparente Grigio con **maniglia T16** verniciato Moka Shine
Scrittoio Nobilitato rovere Bruno
Pensili a giorno Nobilitato rovere Bruno
Luci a led su ripiani e **tubi appendiabiti** verniciato Moka Shine
FIL specchiera (per questo articolo vedi LETTI E GRUPPI NOTTE)
DENNY pouf, **RAKU** panca (per questi articoli vedi COMPLEMENTI)

→ EN

Back panels Piasentina surfaced, Bruno oak surfaced
Shelves Matt Nude lacquer, Bruno oak surfaced, Matt Pacifico lacquer,
Drawer units Bruno oak surfaced, Grigio transparent glass with **T16 handle** painted in Moka Shine
Desk Bruno oak surfaced
Open wall units Bruno oak surfaced
LED lighting on shelves and **clothes rails** painted in Moka Shine
FIL mirror (Please see BEDS AND STORAGE UNITS for this item)
DENNY footstool, **RAKU** bench (Please see COMPLEMENTS for these items)



finiture / finishes
Fashion wood rovere Naturale / Naturale oak Fashion Wood
Fashion wood rovere Ghiro / Ghiro oak Fashion Wood

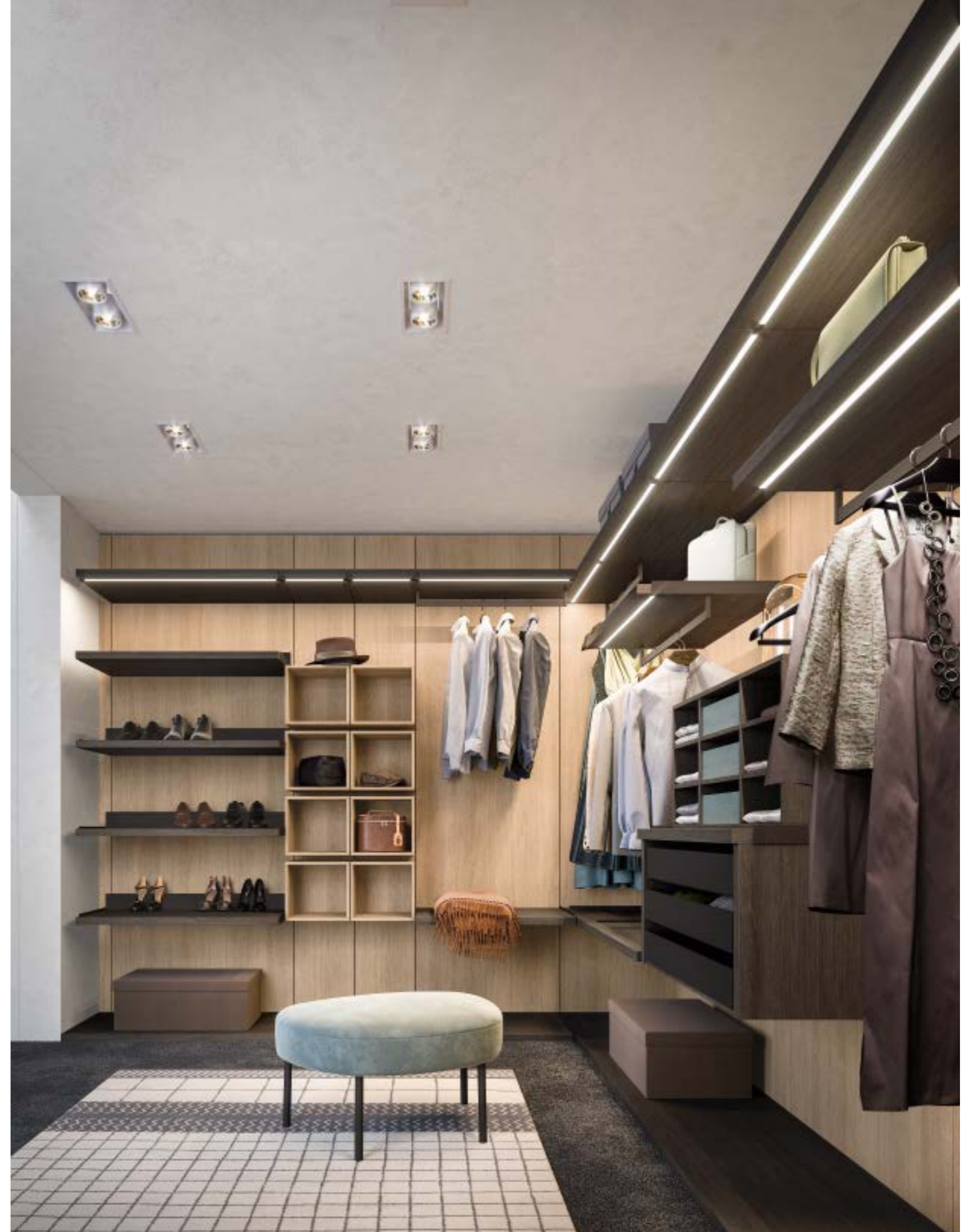

L298,5 X 374 P57,6 H255

→ IT

Schienali Fashion wood rovere Naturale
Ripiani Fashion wood rovere Ghiro
Cassettiera Fashion wood rovere Naturale con **vassoio estraibili** telaio alluminio finitura Grigio fumo
Raster Fashion wood rovere Ghiro con **scatole** rivestite in tessuto
Pensili a giorno Fashion wood rovere Naturale
Luci a led su ripiani e **tubi appendiabiti** verniciato Moka Shine
JETTY letto
(per questo articolo vedi LETTI E GRUPPI NOTTE)
MALMO tavolino, **RAKU** pouf
(per questi articoli vedi COMPLEMENTI)

→ EN

Back panels Naturale oak Fashion Wood
Shelves Ghiro oak Fashion Wood
Drawer unit Naturale oak Fashion Wood with **pull-out trays** aluminium frame in Grigio Fumo finish
Cubby-hole unit Ghiro oak Fashion Wood with fabric-upholstered **boxes**
Open wall units Naturale oak Fashion Wood
LED lighting on shelves and **clothes rails** painted in Moka Shine
JETTY bed
(Please see BEDS AND STORAGE UNITS for this item)
MALMO occasional table, **RAKU** footstool
(Please see COMPLEMENTS for these items)

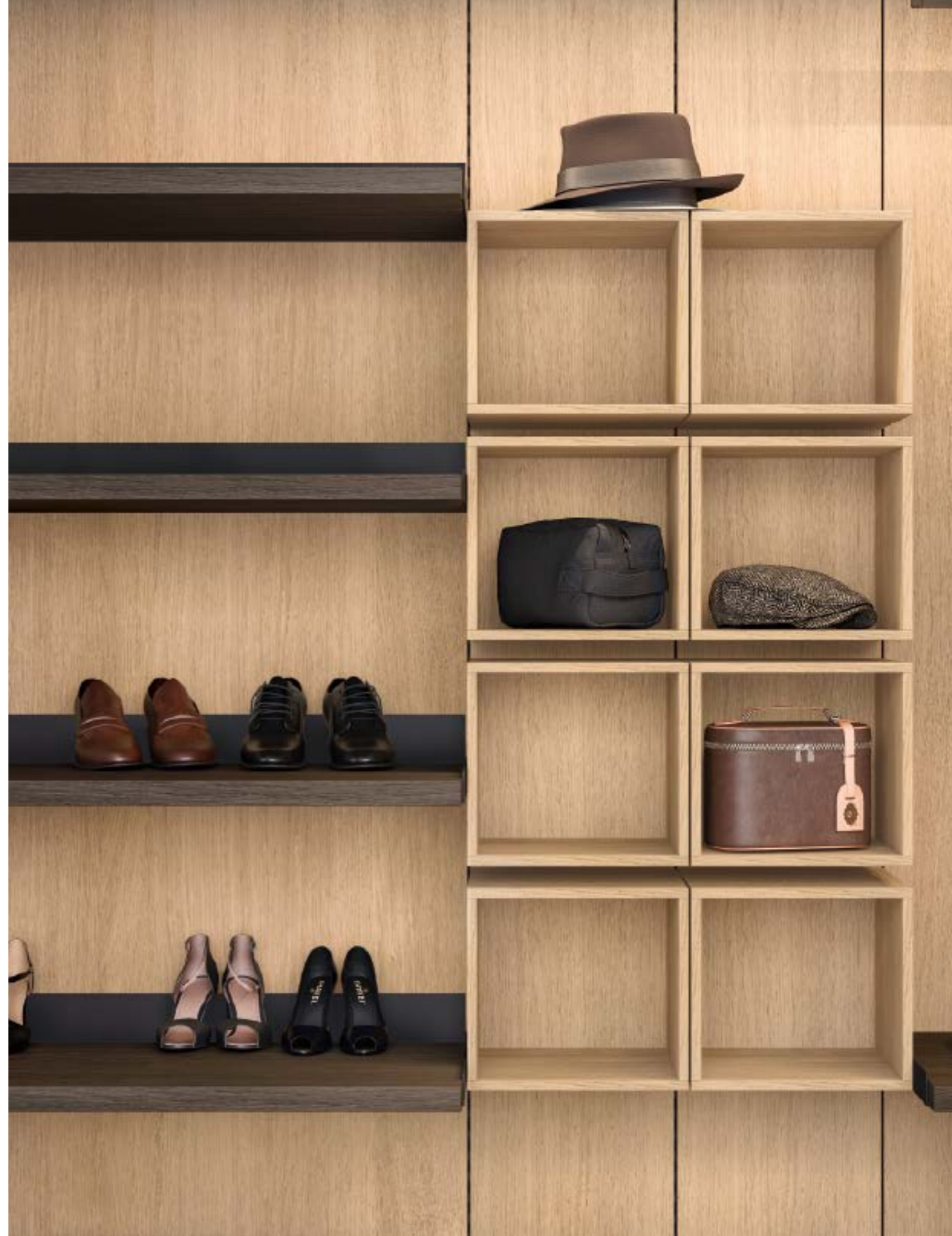





finiture / finishes
Nobilitato Eukalipto cenere / Eukalipto Cenere surfaced
Laccato opaco Aghata / Matt Aghata lacquer



L352,8 P59,3 H227

→ IT

Schienali Nobilitato Eukalipto cenere
Schienale con specchio Grigio
Ripiani Laccato opaco Aghata
Cassettiere Laccato opaco Aghata e **Maniglia**
 pomolo pelle verniciato Moka Shine / cuoio Grigio
Luci a led su ripiani
DENNY pouf, **RAKU** panca
 (per questi articoli vedi COMPLEMENTI)

→ EN

Back panels Eukalipto Cenere surfaced
Back panel with Grigio mirror
Shelves Matt Aghata lacquer
Drawer units Matt Aghata lacquer and leather
 knob **handle** painted in Moka Shine / Grigio
 leather
LED lighting on shelves
DENNY footstool, **RAKU** bench
 (Please see COMPLEMENTS for these items)



comp. Store / 04



finiture / finishes
Nobilitato Gurè / Gurè surfaced
Laccato opaco Platino / Matt Platino lacquer



L238,4 P59,6 H277

→ IT

Schienali Nobilitato Gurè
Ripiani Laccato opaco Platino
Cassettiere Laccato opaco Platino e **Maniglia T16** verniciato Moka Shine
Raster Laccato opaco Platino con **scatole** rivestite in tessuto **Luci a led** su ripiani e **tubi appendiabiti** verniciato Moka Shine

→ EN

Back panels Gurè surfaced
Shelves Matt Platino lacquer
Drawer units Matt Platino lacquer and **T16 handle** painted in Moka Shine
Cubby-hole unit Matt Platino lacquer with fabric-upholstered **boxes**
LED lighting on shelves and **clothes rails** painted in Moka Shine

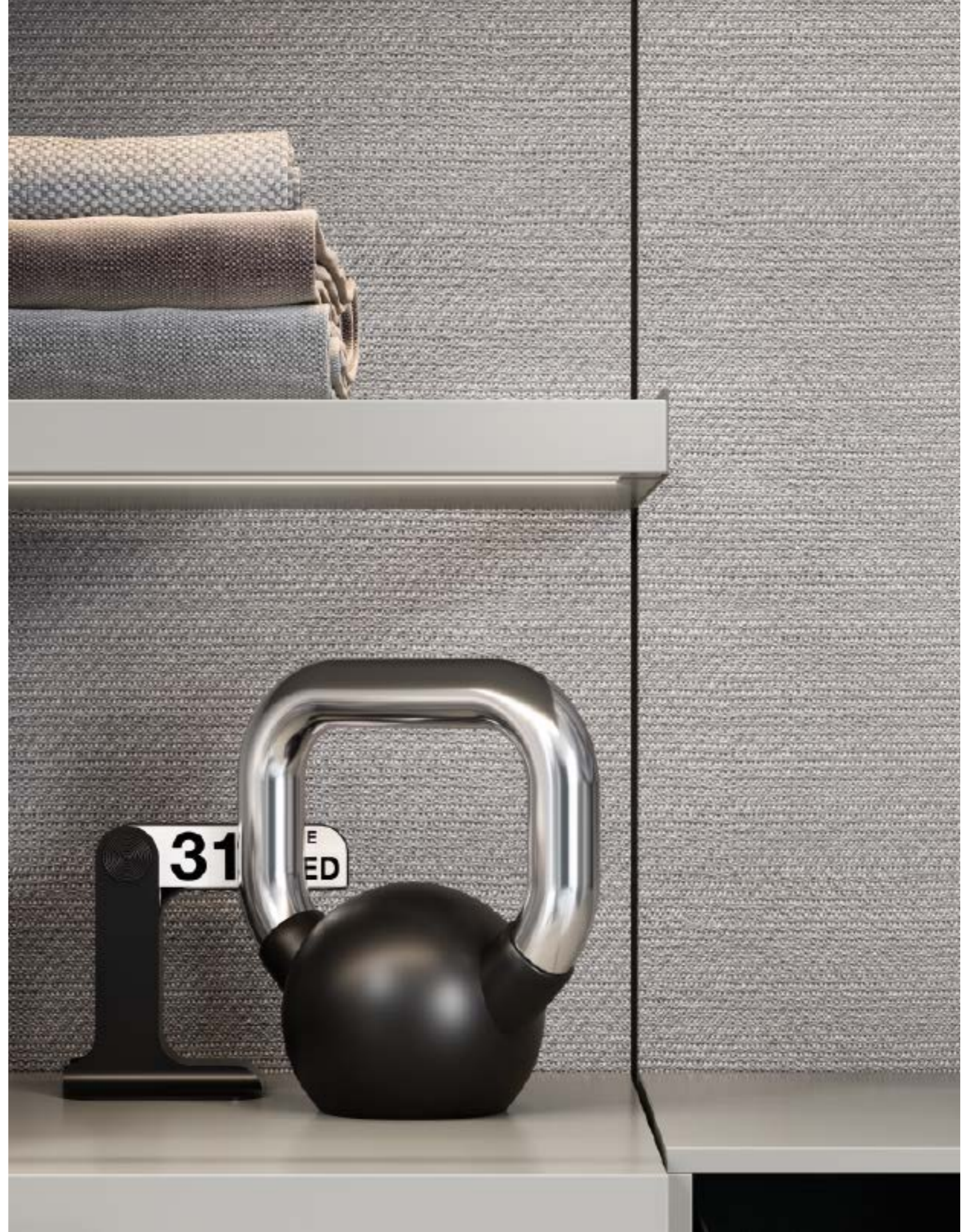

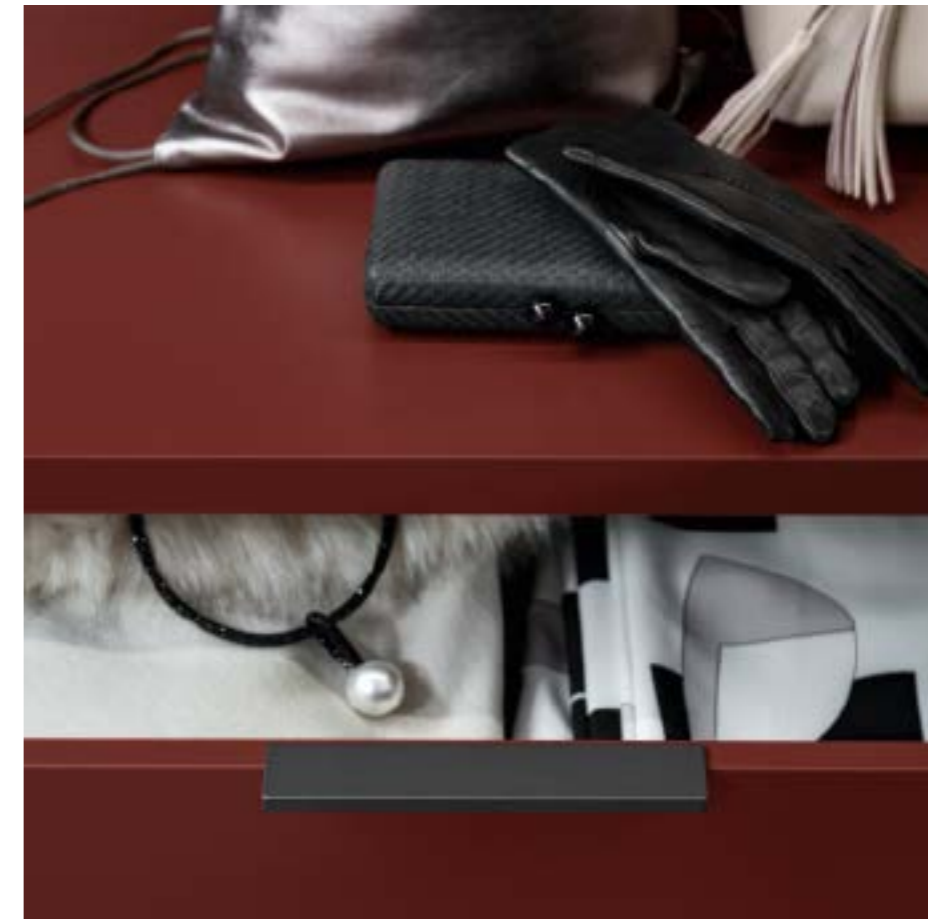

finiture / finishes
Laccato opaco Modica / Matt Modica lacquer
Laccato opaco Amaranto / Matt Amaranto lacquer









L278,4 X 509,6 P59,6 H270

→ IT

Schienali Laccato opaco Modica

Ripiani Laccato opaco Modica

Cassettiere Laccato opaco Amaranto e **Maniglia T16** verniciato Moka Shine

Cassettiera portascarpe Laccato opaco Modica e

Maniglia T16 verniciato Moka Shine

Scrittoio Laccato opaco Amaranto

Pensili a giorno Laccato opaco Modica

Asta portasciarpa verniciato Moka Shine

Luci a led su ripiani e **tubi appendiabiti** verniciato Moka Shine

FIL specchiera (per questo articolo vedi LETTI E GRUPPI NOTTE)

DENNY pouf (per questo articolo vedi COMPLEMENTI)

→ EN

Back panels Matt Modica lacquer

Shelves Matt Modica lacquer

Drawer units Matt Amaranto lacquer and **T16 handle** painted in Moka Shine

Shoe rack drawer unit Matt Modica lacquer and **T16 handle** painted in Moka Shine

Desk Matt Amaranto lacquer

Open wall units Matt Modica lacquer

Scarf rail painted in Moka Shine

LED lighting on shelves and **clothes rails** painted in Moka Shine

FIL mirror (Please see BEDS AND STORAGE UNITS for this item)

DENNY footstool (Please see COMPLEMENTS for this item)

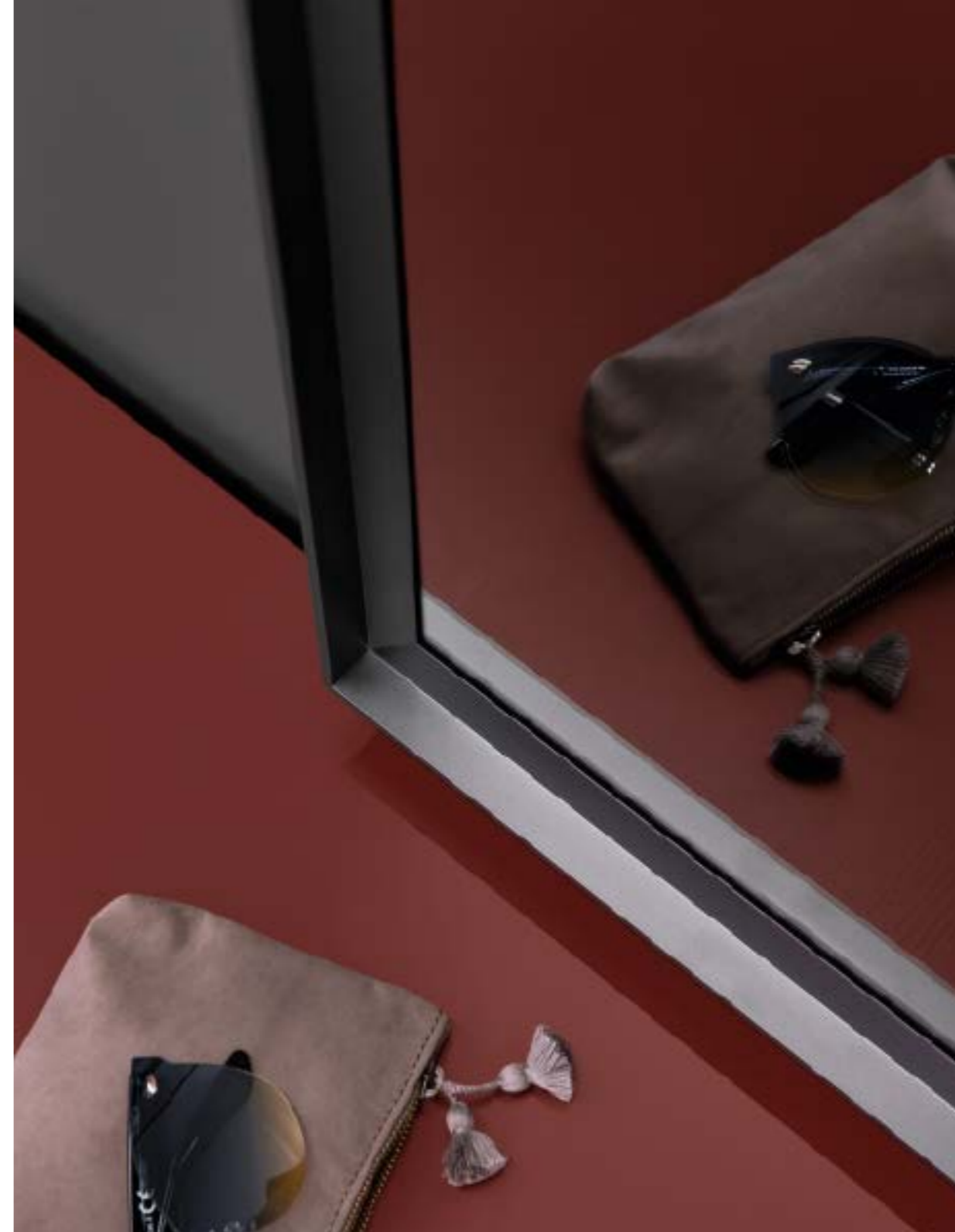



ANTIS
è un sistema composto da "montanti"
attrezzabili caratterizzato dalla libertà di
scelta in altezza e di posizione degli elementi
con la possibilità di creare molteplici
configurazioni.

ANTIS is a system of "uprights" you can accessorise and build freely. You choose the height and position of the different elements to create infinite configurations.

ANTIS es un sistema formado por "montantes" equipables caracterizado por la posibilidad de elegir libremente la altura y la posición de los elementos, permitiendo crear diversas configuraciones.

ANTIS est un système composé de « montants » pouvant être équipés, caractérisé par la liberté de choix en hauteur et de position des éléments avec la possibilité de créer de multiples configurations.

ANTIS ist ein System, das aus ausstattbaren Montageleisten besteht. Es zeichnet sich besonders durch seine außergewöhnliche Flexibilität bei der Wahl der Höhe und der Position der Elemente sowie seine zahlreichen Kombinationsmöglichkeiten aus.

ANTIS - система из оснащаемых «стоек», характеризующаяся свободой выбора высоты и положения элементов с возможностью создания многочисленных конфигураций.

comp. Antis / 01



finitura / finish
Fashion wood rovere Naturale / Naturale oak Fashion Wood



pag. 34
comp. sx L236 P47,5 H247
comp. dx L140 P38 H247

→ IT
Struttura verniciato Moka Shine
Mensola Fashion wood rovere Naturale
Mensola portascarpe Fashion wood rovere Naturale / verniciato Moka Shine
Contenitore Fashion wood rovere Naturale e Maniglia I verniciato Moka Shine
Contenitori Vas Fashion wood rovere Naturale
Tubi appendiabiti verniciato Moka Shine
RAKU Panca
(per questo articolo vedi COMPLEMENTI)

→ EN
Structure painted in Moka Shine
Shelves Naturale oak Fashion Wood
Shoe shelf Naturale oak Fashion Wood / painted in Moka Shine
Storage unit Naturale oak Fashion Wood and I handle painted in Moka Shine
Vas storage units Naturale oak Fashion Wood
Clothes rails painted in Moka Shine
RAKU bench
(Please see COMPLEMENTS for this item)

comp. Antis / 02



finitura / finish
Fashion wood rovere Carbone / Carbone oak Fashion Wood



pag. 38/39
 comp. sx L204 P47,5 H300
 comp. centro L303 P45 H300
 comp. dx L203,9 P45,1 H300

→ **IT**
Struttura verniciato Moka Shine
Mensole Fashion wood rovere Carbone
Mensole portascarpe Fashion wood rovere Carbone / verniciato Moka Shine
Contenitori Fashion wood rovere Carbone e **Maniglia pomolo pelle** verniciato Moka Shine / cuoio Grigio
Contenitori VAS Fashion wood rovere Carbone
Tubi appendiabiti verniciato Moka Shine
Isola cassette STORE Fashion wood rovere Carbone / vetro trasparente grigio e **Maniglia T16** verniciato Moka Shine
RAKU Poltroncina (per questo articolo vedi COMPLEMENTI)

→ **EN**
Structure painted in Moka Shine
Shelves Carbone oak Fashion Wood
Shoe shelves Carbone oak Fashion Wood / painted in Moka Shine
Storage units Carbone oak Fashion Wood and **leather knob handle** painted in Moka Shine / Grigio leather
Vas STORAGE UNITS Carbone oak Fashion Wood
Clothes rails painted in Moka Shine
STORE island unit with drawers Carbone oak Fashion Wood / Grigio transparent glass and **T16 handle** painted in Moka Shine
RAKU armchair (Please see COMPLEMENTS for this item)





finitura / finish
Laccato opaco Nude / Matt Nude lacquer

L466 P47,5 H255

→ IT

Struttura verniciato Moka Shine
Mensole Laccato opaco Nude
Contenitori Laccato opaco Nude
Contenitori VAS Laccato opaco
Nude con cassetti Cuoio 1031
e **Maniglia M** verniciato Moka
Shine
Tubi appendiabiti verniciato
Moka Shine
MALMO tavolino, **RAKU**
poltroncina
(per questi articoli vedi
COMPLEMENTI)

→ EN

Structure painted in Moka Shine
Shelves Matt Nude lacquer
Storage units Matt Nude lacquer
VAS storage units Matt Nude
lacquer with 1031 leather drawers
and **M handle** painted in Moka
Shine
Clothes rails painted in Moka
Shine
MALMO occasional table,
RAKU armchair
(Please see COMPLEMENTS
for these items)



44



comp. 03

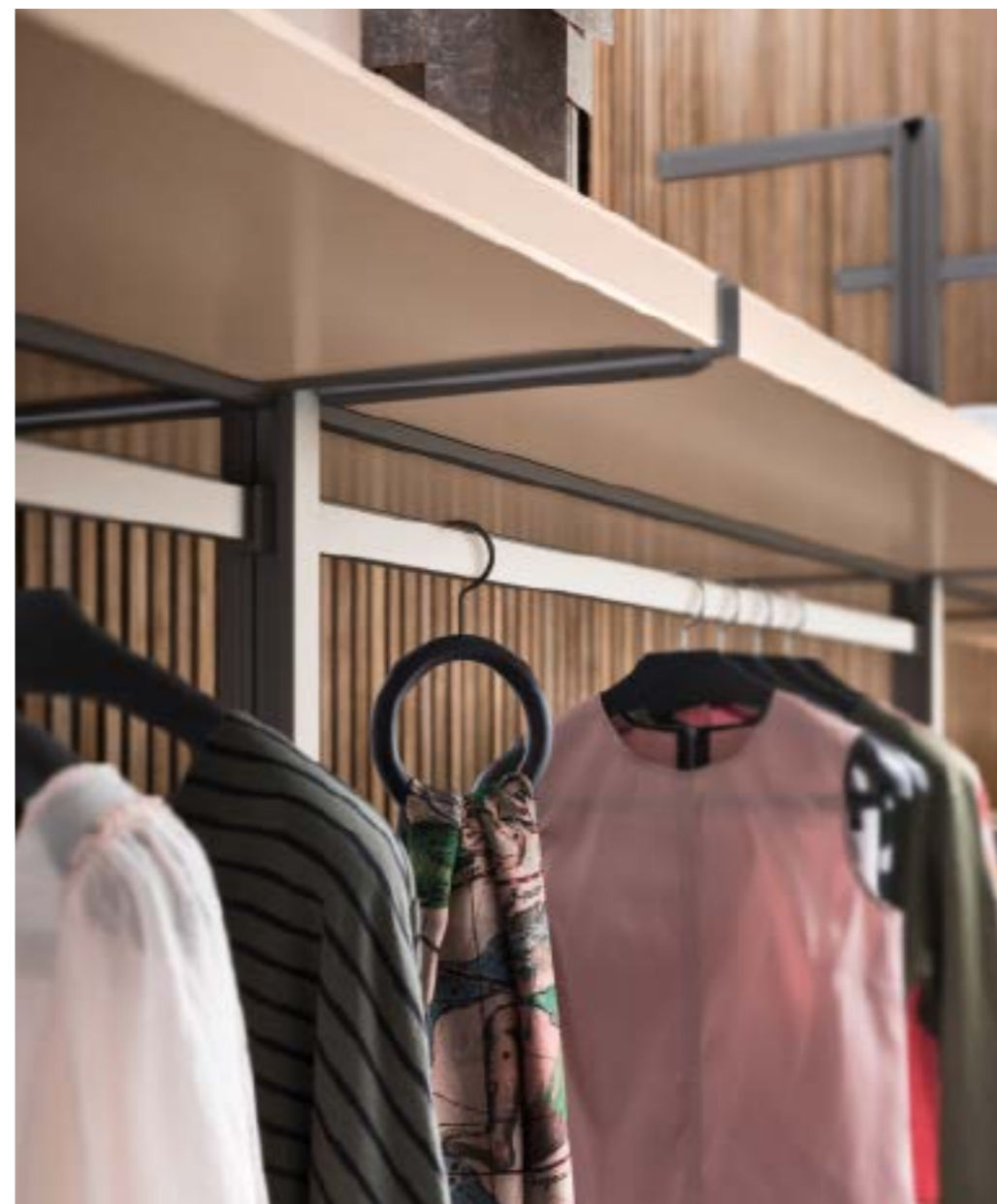

ANTIS

Alf DaFrè

45





L136,8 P45 H200

→ IT
Struttura verniciato Moka Shine
Mensole Laccato opaco Tè verde
Tubi appendiabiti verniciato Moka Shine
RAKU panca (per questo articolo vedi COMPLEMENTI)

→ EN
Structure painted in Moka Shine
Shelves Matt Tè Verde lacquer
Clothes rails painted in Moka Shine
RAKU bench (please see COMPLEMENTS for this item)





L204 P63,5 H232

→ IT

Struttura verniciato Moka Shine
Mensole Laccato opaco Tortora
Scrittoio Laccato opaco Tortora
Contentore Laccato opaco Tortora e **Maniglia T16** verniciato Moka Shine
Tubi appendiabiti verniciato Moka Shine
ESAGONA specchiera (per questo articolo vedi NEWS 2019)
RAKU poltroncina (per questo articolo vedi COMPLEMENTI)

→ EN

Structure painted in Moka Shine
Shelves Matt Tortora lacquer
Desk Matt Tortora lacquer
Storage units Matt Tortora lacquer and **T16 handle** painted in Moka Shine
Clothes rails painted in Moka Shine
ESAGONA mirror (Please see NEWS 2019 for this item)
RAKU armchair (Please see COMPLEMENTS for this item)



Caratteristiche tecniche STORE / STORE technical characteristics



Profilo cremagliera STORE / STORE rack profile

→ **IT**
La cabina STORE è dotata di un pratico sistema di fissaggio a cremagliera che permette di riposizionare i vari elementi.

→ **EN**
The STORE walk-in wardrobe has a practical rack fixing mechanism, so the different elements can be repositioned.



Caratteristiche tecniche cabina STORE / STORE walk-in wardrobe technical characteristics

→ IT

La cabina può essere completata con: schienali, ripiani, panca, scrittoio, tubo appendiabiti, cassettiere, raster, pensili a giorno, accessori e barra led.

→ EN

The walk-in wardrobe can be finished with: back panels, shelves, a bench, a desk, clothes rails, drawer units, cubby-hole units, open wall units, accessories and LED lighting.

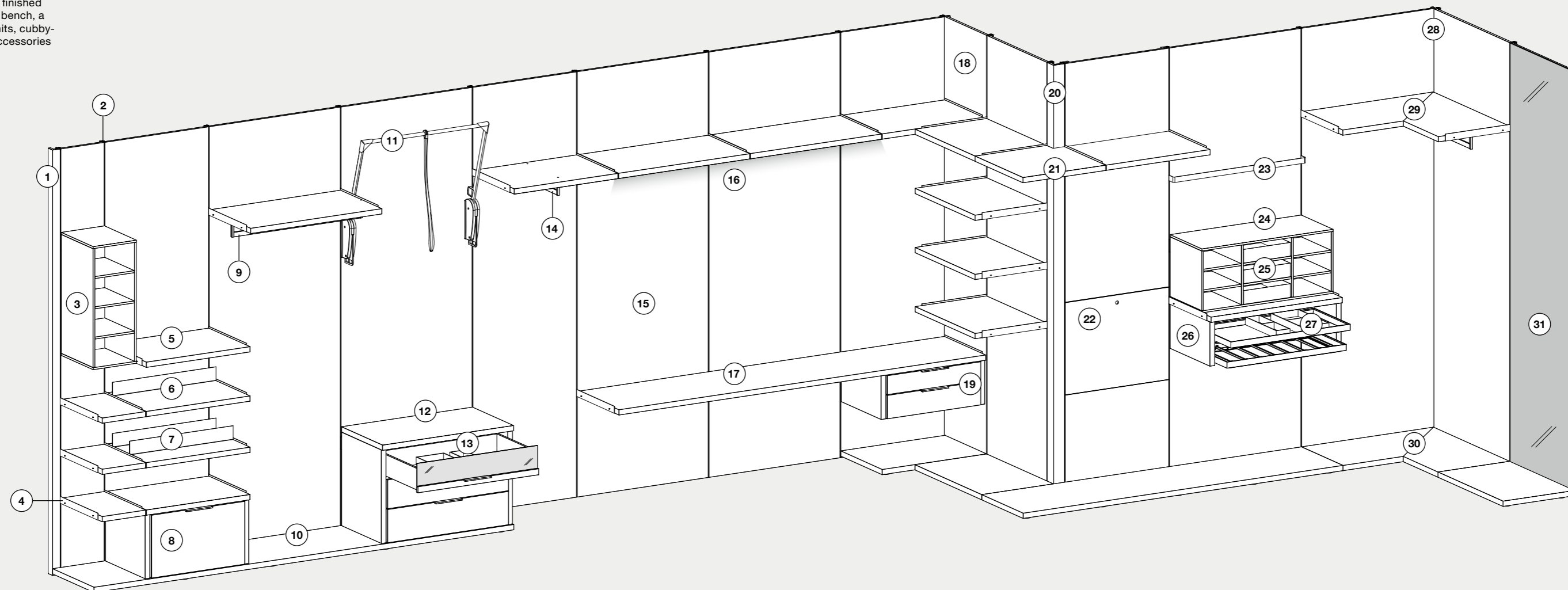

1 / Fascia di tamponamento terminale Sp. 1,8 cm
End filler strip 1.8 cm thick

2 / Profilo cremagliera in alluminio
Aluminium rack profile

3 / Pensili a giorno
Open wall units

4 / Staffa Sp. 0,3 cm in metallo
Metal bracket 0.3 cm thick

5 / Ripiano Sp. 3,5 cm
Shelf 3.5 cm thick

6 / Ripiano Sp. 3,5 cm con 1 portascarpe
Shelf 3.5 cm thick with 1 shoe rack

7 / Ripiano Sp. 3,5 cm con 2 portascarpe
Shelf 3.5 cm thick with 2 shoe racks

8 / Cassetiera con cesto portascarpe con frontale legno e staffe in metallo
Drawer unit with large shoe storage drawer with wooden front and metal brackets

9 / Tubo appendiabiti con sviluppo in larghezza
Widthways clothes rail

10 / Panca Sp. 3,5 cm
Bench 3.5 cm thick

11 / Servetto oleodinamico
Hydraulic pull-down rack

12 / Cassetiera con frontale vetro trasparente grigio/legno e staffe in metallo
Drawer unit with Grigio transparent glass/wooden front and metal brackets

13 / Scatole portaoggetti rivestite in tessuto per cassetto
Fabric-upholstered storage boxes for drawers

14 / Tubo appendiabiti con sviluppo in profondità
Depthways clothes rail

15 / Schienale Sp. 1,8 cm
Back panel 1.8 cm thick

16 / Barra led per ripiani
LED strip light for shelves

17 / Scrittoio Sp. 3,5 cm
Desk 3.5 cm thick

18 / Schienale angolo L Sp. 1,8 cm
L-shaped corner back panel 1.8 cm thick

19 / Cassetiera con frontale legno e staffe in metallo
Drawer unit with wooden front and metal brackets

20 / Schienale angolo aperto Sp. 1,8 cm
Open corner back panel 1.8 cm thick

21 / Ripiano Sp. 3,5 cm per angolo aperto
Shelf 3.5 cm thick for open corner

22 / Schienale ispezionabile Sp. 1,8 cm
Peep back panel 1.8 cm thick

23 / Asta portascarpe
Scarf rail

24 / Raster
Cubby-hole unit

25 / Scatole rivestite in tessuto per raster
Fabric-upholstered boxes for cubby-hole units

26 / Cassetiera con 1 vassoio estraibile e 1 portapantaloni con telaio alluminio
Drawer unit with 1 pull-out tray and 1 pull-out trouser rack with aluminium frame

27 / Scatole portaoggetti rivestite in tessuto per vassoio estraibile
Fabric-upholstered storage boxes for pull-out tray

28 / Angolo fuorisquadra
Out-of-square corner

29 / Ripiano fuorisquadra Sp. 3,5 cm
Out-of-square shelf 3.5 cm thick

30 / Panca fuorisquadra Sp. 3,5 cm
Out-of-square bench 3.5 cm thick

31 / Schienale con specchio Sp. 1,8 cm
Back panel with mirror 1.8 cm thick



1 / Pensile a giorno
Open wall unit

2 / Panca
Bench

3 / Tubo appendiabiti con
sviluppo in profondità
Depthways clothes rail

4 / Cassettiera con cesto
portascarpe
Shoe rack drawer unit

5 / Raster con scatole
rivestite in tessuto
Cubby-hole unit with fabric-
upholstered boxes

6 / Vassoio portapantaloni
Trousers tray

7 / Cassettiera
Drawer unit

8 / Ripiano
Shelf

9 / Servetto oleodinamico
Hydraulic pull-down rack

10 / FIL specchiera (per questo
articolo vedi Letti e gruppi notte)
FIL mirror (please see BEDS AND
STORAGE UNITS for this item)

11 / Asta portascarpe
Scarf rail

12 / Scrivania
Desk

13 / Tubo appendiabiti con
sviluppo in larghezza
Widthways clothes rail

14 / Schienale con specchio
Back panel with mirror

Cassettiere e vassoi estraibili / Pull-out drawer units and trays

→ **IT**
Il programma STORE dispone di cassettiere con frontali legno vetro o a giorno e di vassoi estraibili in alluminio.

→ **EN**
The STORE collection features drawer units with wooden, glass or open fronts and pull-out aluminium trays.

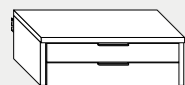

Cassettiera con cassetti con frontale legno
Drawer unit with wooden-fronted drawers



Cassettiera con cassetti con frontale vetro trasparente grigio/legno
Drawer unit with Grigio transparent glass/wooden-fronted drawers

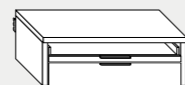

Cassettiera con cassetti con frontale a giorno/legno
Drawer unit with open/wooden-fronted drawers

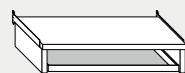

Cassettiera con vassoi estraibili con telaio alluminio finitura grigio fumo H. 5 cm
Drawer unit with pull-out trays with aluminium frame in Grigio Fumo finish H. 5 cm



Cassettiera con vassoi estraibili con telaio alluminio finitura grigio fumo H. 11 cm
Drawer unit with pull-out trays with aluminium frame in Grigio Fumo finish H. 11 cm



Accessori per cassetti e vassoi / Accessories for drawers and trays

Scatole portaoggetti H. 5 cm rivestite in tessuto
Fabric-upholstered storage boxes H. 5 cm



Scatole portaoggetti P. 44,7 cm rivestite in tessuto per cassetto
Storage boxes D. 44.7 cm upholstered in fabric for drawers



Scatole portaoggetti P. 38,5 cm rivestite in tessuto per vassoio estraibile
Storage boxes D. 38.5 cm upholstered in fabric for pull-out tray



Proposte accessori per cassetti e vassoi / Examples of accessories for drawers and trays

Esempi di posizionamento scatola portaoggetti per CASSETTO
Examples of how to position the storage compartments in a drawer

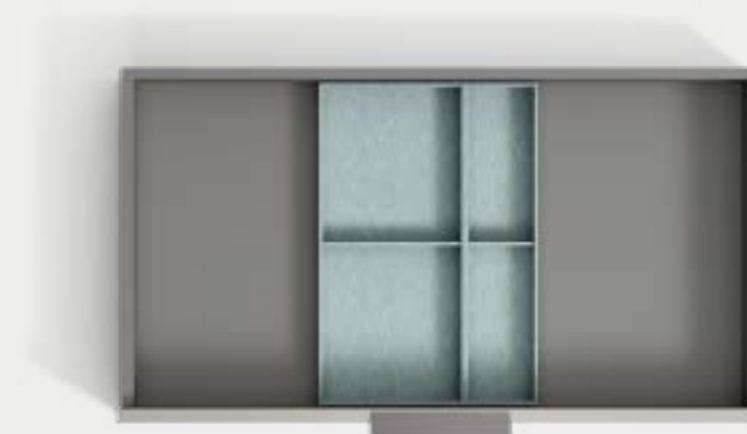

Esempi di posizionamento scatola portaoggetti per VASSOIO ESTRAIBILE
Examples of how to position the storage compartments on a pull-out tray



Portapantaloni e portagonne estraibili / Pull-out trouser and skirt racks

→ **IT**
Disponibili pratici portapantaloni e portagonne estraibili in alluminio.

→ **EN**
Practical, pull-out aluminium trouser and skirt racks are also available.



Portapantaloni estraibile con telaio alluminio finitura grigio fumo H. 5 cm
Pull-out trouser rack with aluminium frame in Grigio Fumo finish H. 5 cm



Portagonne estraibile con telaio alluminio finitura grigio fumo H. 5 cm
Pull-out skirt rack with aluminium frame in Grigio Fumo finish H. 5 cm



Soluzioni portascarpe / Shoe-rack solutions

→ **IT**
STORE offre diverse soluzioni portascarpe come il cestone o i ripiani attrezzati con divisori in metallo.

→ **EN**
STORE offers various shoe storage solutions such as the XL drawer or shelves with metal dividers.

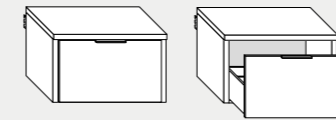

Cassettiera con cesto portascarpe
Drawer unit with large shoe storage drawer

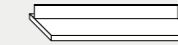

Ripiano con portascarpe
Shelf with shoe rack



Raster e pensili a giorno / Cubby-hole unit and open wall units

→ **IT**
Ogni oggetto trova la sua perfetta collocazione tramite raster attrezzabili anche con scatole in tessuto e pensili a giorno.

→ **EN**
There's room for all your possessions in the cubby-hole units that can also be equipped with fabric boxes, and open wall units.

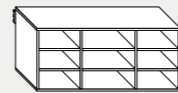

Raster
Cubby-hole unit



Scatole rivestite in tessuto per raster
Fabric-upholstered boxes for cubby-hole units



Pensile a giorno
Open wall units

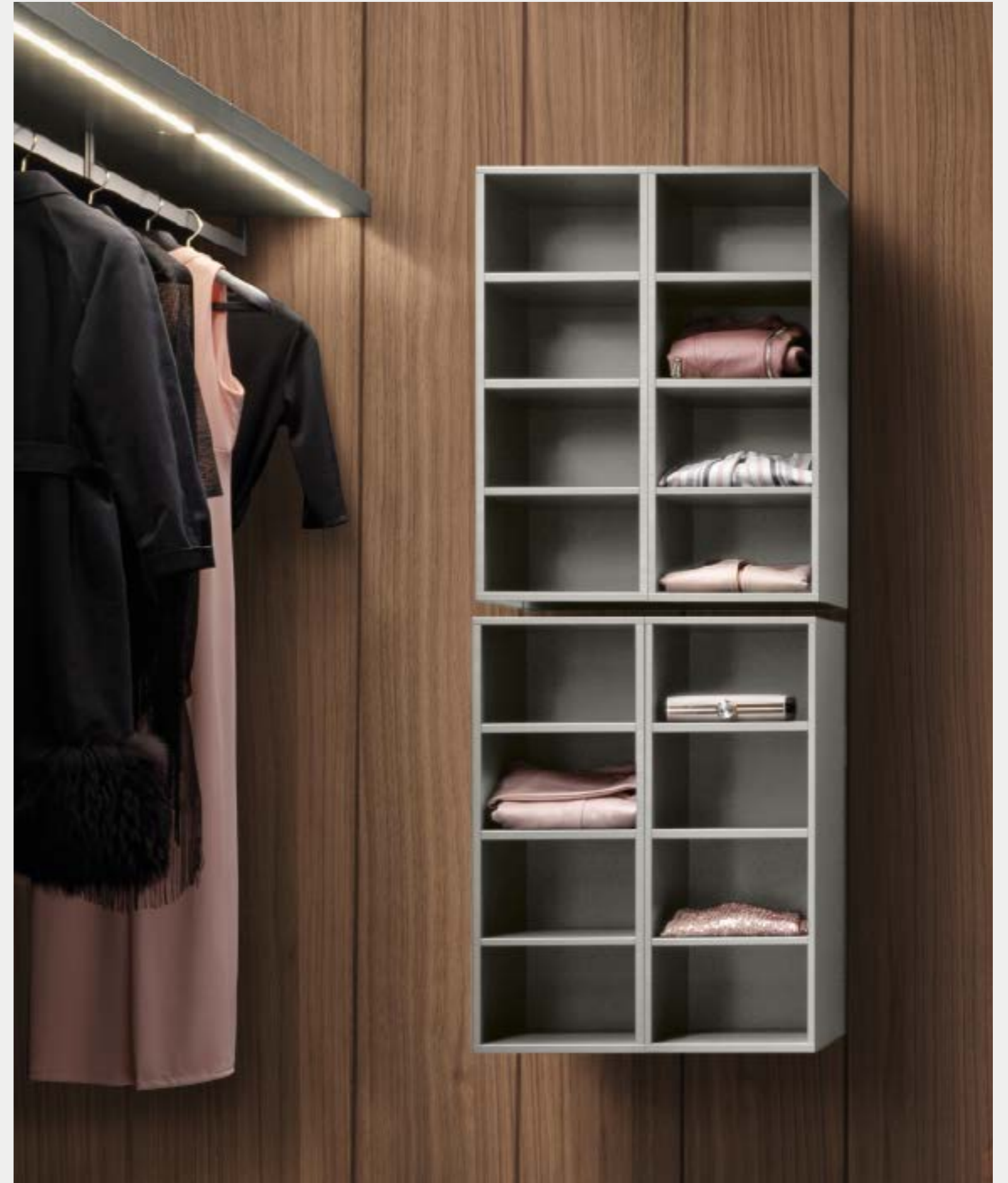



Scrivania / Desk

→ **IT**
 La cabina diventa vanity o home office con il pratico scrivania, anche con cassettiere.

→ **EN**
 The walk-in wardrobe area can also serve as a dressing table or home office space with a practical desk, and additional drawer unit.

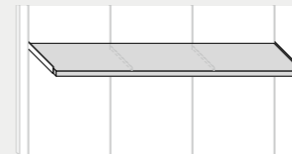

Scrivania
 Desk

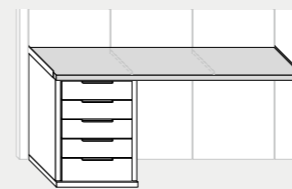

Scrivania con cassettiere
 Desk with drawer unit

Illuminazione / Lighting

→ **IT**
L'illuminazione della cabina è affidata a barre a led perfettamente integrate nel design dei ripiani.

→ **EN**
LED lighting is perfectly integrated into the shelf design to brighten the space.

Barra led per ripiani
LED strip light for shelves



Appenderia / Hanging rails

→ **IT**
I tubi appendiabiti in metallo possono essere posizionati in senso longitudinale o trasversale.

→ **EN**
The metal clothes rails can be installed lengthways or depthways.

Tubo appendiabiti con sviluppo in larghezza
Widthways clothes rail



Tubo appendiabiti con sviluppo in profondità
Depthways clothes rail



Appenderia / Hanging rails

→ **IT**
Gruccie con portapantaloni, portasciarpe e porta abiti, molteplici soluzioni per ogni esigenza.

→ **EN**
Hangers with a trouser bar, scarf rings and clothes racks: storage solutions for your every need.

Anello portasciarpa
Scarf ring



Gruccia con portapantaloni
Hanger with trouser bar



Asta portasciarpe
Scarf rail



Forcella appendiabiti
High-reach clothes hook



Servetto oleodinamico
Hydraulic pull-down rack



Schienali specchio / Mirrored back panels

→ **IT**
Lo schienale cabina diventa specchio disponibile in anche in una elegante versione in finitura grigia.

→ **EN**
The walk-in wardrobe back panels can be used as a mirror, also available in an elegant Grigio finish.

Schienale con specchio
Back panel with mirror



Schienale con specchio grigio
Back panel with Grigio mirror

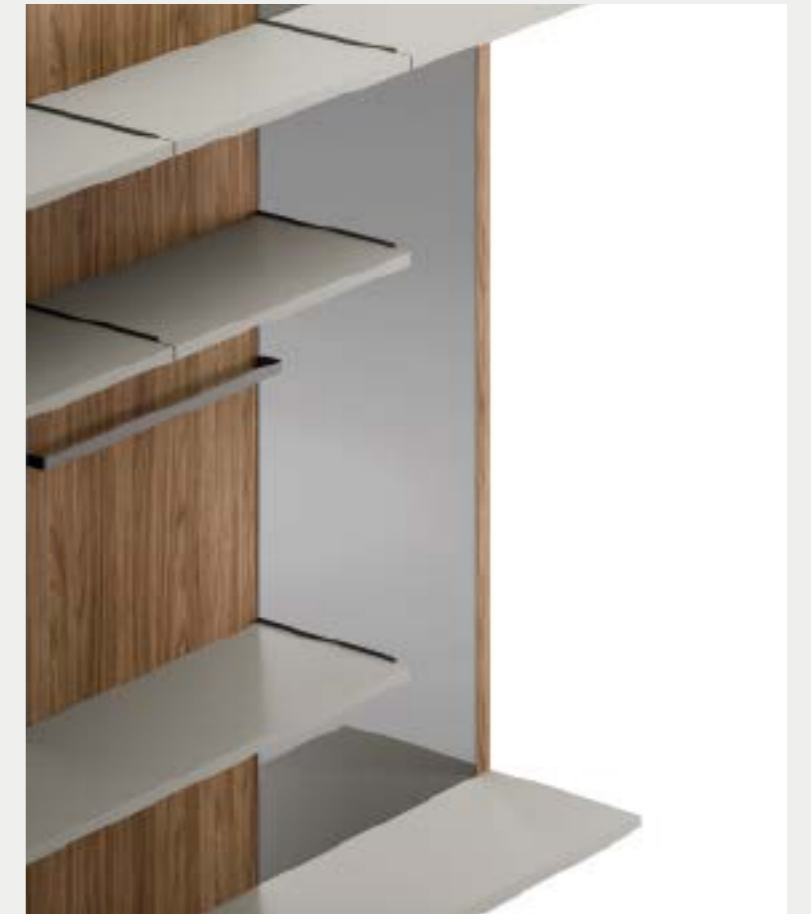

Isola cassetti esterna / External drawer-unit island

→ **IT**

Una vera e propria "isola" che completa la zona cabina
Dotata di cassetti con frontale legno o vetro e pratiche zone a giorno.

→ **EN**

An "island" unit to complete the walk-in wardrobe area
Fitted with drawers with a wooden or glass front and practical open-fronted compartments.



Isola cassetti esterna con frontale legno e maniglia T16
Island unit with external drawers, wooden fronts and T16 handle



Isola cassetti esterna con frontale legno e pomolo pelle
Island unit with external drawers, wooden fronts and leather knob



Isola cassetti esterna con frontale vetro trasparente grigio/legno e maniglia T16
Island unit with external drawers, Grigio transparent glass/wooden fronts and T16 handle

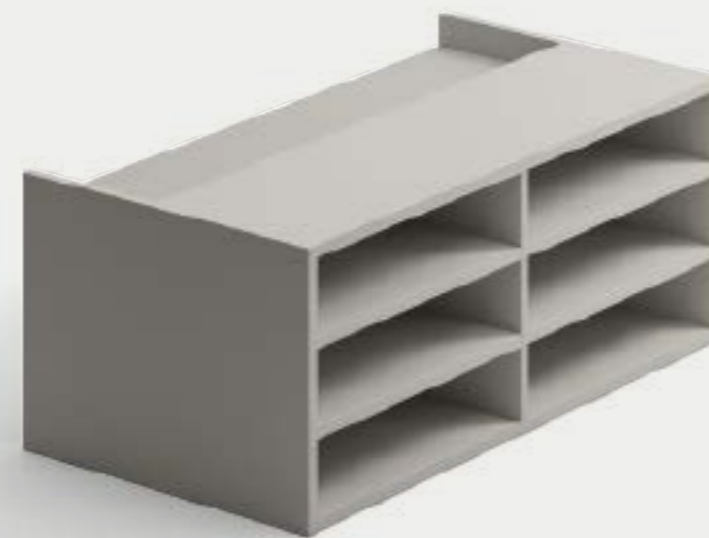

Retro a giorno
Open back

Montante ANTIS / ANTIS upright

→ **IT**

Antis è dotato di montanti posizionabili a soffitto o a parete attrezzabili con contenitori, mensole e accessori. Nella configurazione con montanti a soffitto la composizione può essere bifacciale.

→ **EN**

Antis is equipped with uprights that can be positioned on the ceiling or mounted on the wall, with storage units, shelves and accessories. In the version with ceiling uprights, the composition can be double-sided.



Montante a soffitto/bifacciale
Ceiling/double-sided upright



Montante a parete
Wall upright



Caratteristiche tecniche cabina ANTIS / ANTIS walk-in wardrobe technical characteristics

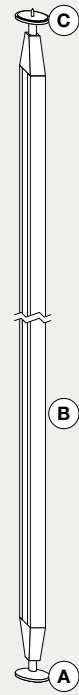

Montante a soffitto / bifacciale
Ceiling/double-sided upright

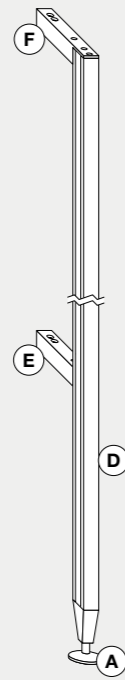

Montante a parete
Wall upright

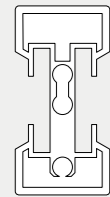

Sezione montante a soffitto / bifacciale
Cross-section of ceiling/double-sided upright



Sezione montante a parete
Wall upright cross-section

A / Piede a terra Ø 5,7 cm (in appoggio a terra).
N.B. permette la regolazione in altezza di 1 cm.
Foot Ø 5.7 cm (floor-standing).
N.B. Adjust the unit height by 1 cm.

B / Profilo per montante a soffitto in estruso di alluminio verniciato.
Coated extruded aluminium profile for ceiling upright.

C / Piede a soffitto Ø 5,7 cm (fissato con vite al soffitto).
N.B. permette la regolazione in altezza di 1 cm.
Ceiling support Ø 5.7 cm (screwed to the ceiling).
N.B. Adjust the unit height by 1 cm.

A / Piede a terra Ø 5,7 cm (in appoggio a terra).
N.B. permette la regolazione in altezza di 1 cm.
Foot Ø 5.7 cm (floor-standing).
N.B. Adjust the unit height by 1 cm.

D / Profilo per montante a parete in estruso di alluminio verniciato.
Coated extruded aluminium profile for wall upright.

E / Traverso centrale in estruso di alluminio verniciato (sempre presente a prescindere dall'altezza).
Coated extruded aluminium central crosspiece (always required, regardless of height).

F / Traverso superiore in estruso di alluminio verniciato.
Coated extruded aluminium top crosspiece.

Esempio di composizione / Composition examples

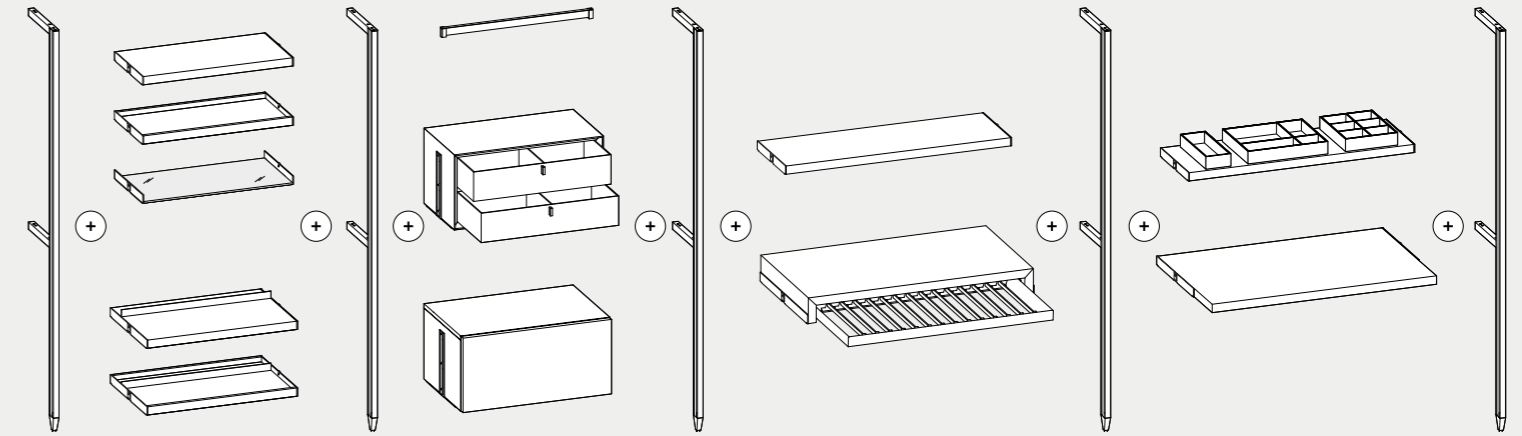

Mensola legno sp. 3,5 cm con staffe in metallo
Wooden shelf 3.5 cm thick with metal brackets

Mensola legno sp. 1,4 cm in folding con staffe in metallo
Folded wooden shelf 1.4 cm thick with metal brackets

Mensola vetro trasparente grigio Sp. 0,8 cm con staffe in metallo
Grigio transparent glass shelf 0.8 cm thick with metal brackets

Mensola legno Sp. 3,5 cm con portascarpe e staffe in metallo
Wooden shelf 3.5 cm thick with shoe rack and metal brackets

Mensola legno Sp. 1,4 cm in folding con portascarpe e staffe in metallo
Folded wooden shelf 1.4 cm thick with shoe rack and metal brackets

Tubo appendiabiti
Clothes rail

Scatole rivestite in tessuto per mensole
Fabric-upholstered boxes for shelves

Scrivania Sp. 3,5 cm con staffe in metallo
Desk 3.5 cm thick with metal brackets

Portapantaloni estraibile con vassoio e staffe in metallo
Pull-out trouser racks with tray and metal brackets

Contenitore VAS con staffe in metallo
VAS storage unit with metal brackets

Box interno per contenitore VAS
Internal box for VAS storage unit

Contenitore finito con staffe in metallo
Finished storage unit with metal brackets



1 / Mensola vetro
Glass shelf

2 / Contenitore con cassetti
Storage unit with drawers

3 / Tubo appendiabiti
Clothes rail

4 / Portapantaloni estraibile
Pull-out trouser rack

5 / Mensola legno con portascarpe
Wooden shelf with shoe rack

6 / Mensola legno
Wooden shelf

7 / Contenitori VAS
VAS storage units

8 / Contenitore con anta
Storage unit with door

9 / Mensola legno in folding
Folded wooden shelf

10 / Scatole in tessuto per mensole
Fabric boxes for shelves

11 / Mensola legno in folding con portascarpe
Folded wooden shelf with shoe rack

Mensole / Shelves

→ **IT**
Il sistema Antis è attrezzabile con diverse tipologie di mensole in legno o vetro, vassoi o portascarpe.

→ **EN**
The Antis range can be fitted with different types of wooden or glass shelves, trays and shoe racks.



Mensola legno sp. 3,5 cm con staffe in metallo
Wooden shelf 3.5 cm thick with metal brackets



Mensola legno sp. 1,4 cm in folding con staffe in metallo
Folded wooden shelf 1.4 cm thick with metal brackets



Mensola vetro trasparente grigio Sp. 0,8 cm con staffe in metallo
Grigio transparent glass shelf 0.8 cm thick with metal brackets



Mensola legno Sp. 3,5 cm con portascarpe e staffe in metallo
Wooden shelf 3.5 cm thick with shoe rack and metal brackets



Mensola legno Sp. 1,4 cm in folding con portascarpe e staffe in metallo
Folded wooden shelf 1.4 cm thick with shoe rack and metal brackets



Portapantaloni / Trouser rack

→ **IT**
Disponibile anche un portapantaloni estraibile in alluminio.

→ **EN**
A pull-out aluminium trouser rack is also available.



Contenitori / Storage units

→ **IT**
Con ante a ribalta o vasistas,
a giorno o con pratici cassetti,
tante le soluzioni disponibili.

→ **EN**
With flap or tilt doors, with open
fronts or practical drawers:
there are many solutions to
choose from.



Accessori per mensole / Accessories for shelves

Scatole portaoggetti H. 5 cm rivestite in tessuto
Fabric-upholstered storage boxes H. 5 cm

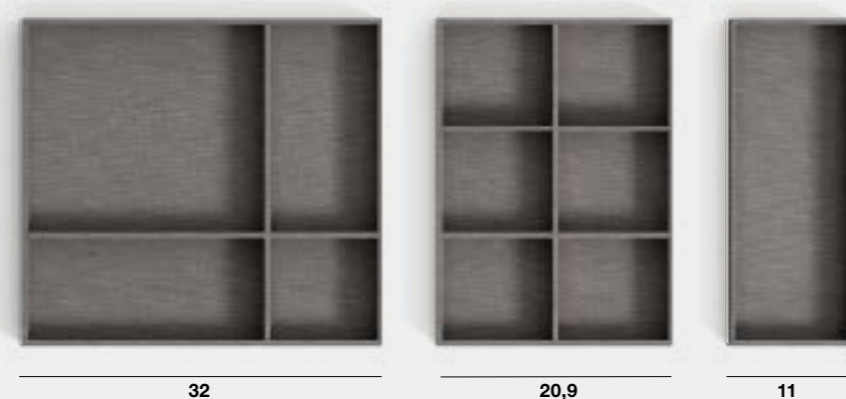

32

20,9

11

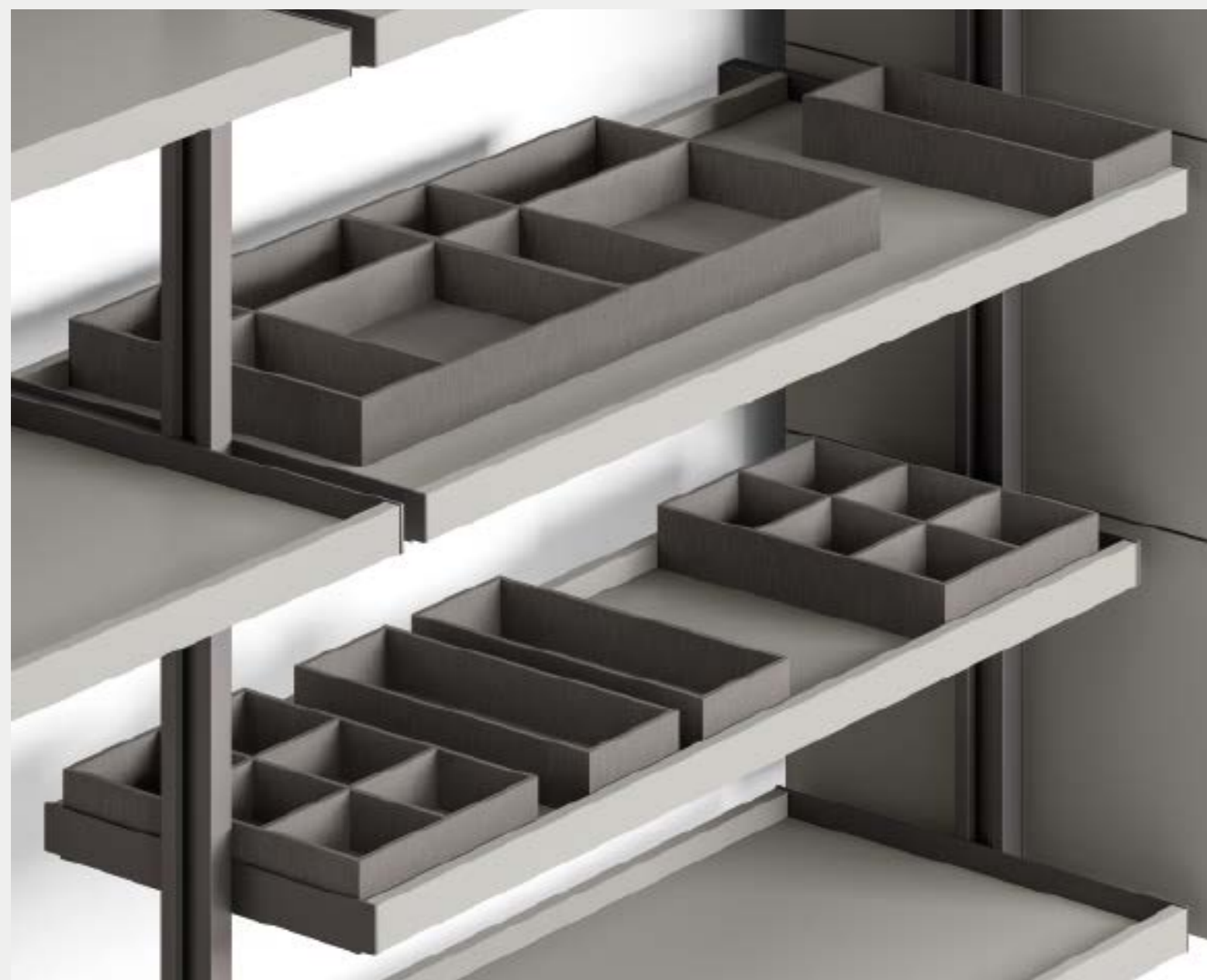

Proposte accessori per mensole / Accessories for shelves

Esempi di posizionamento su mensole P. 32 cm
Examples of how to position on shelves D. 32 cm



Esempi di posizionamento su mensole P. 41,6 cm
Examples of how to position on shelves D. 41.6 cm



Esempi di posizionamento su mensole P. 50 cm
Examples of how to position on shelves D. 50 cm



Appenderia / Hanging rails

→ **IT**
Gruccie con portapantaloni e portasciarpe completano la dotazione.

→ **EN**
Hangers with a trouser bar and scarf rings complete the look.

Gruccia con portapantaloni
Hanger with trouser bar



Anello portasciarpa
Scarf ring

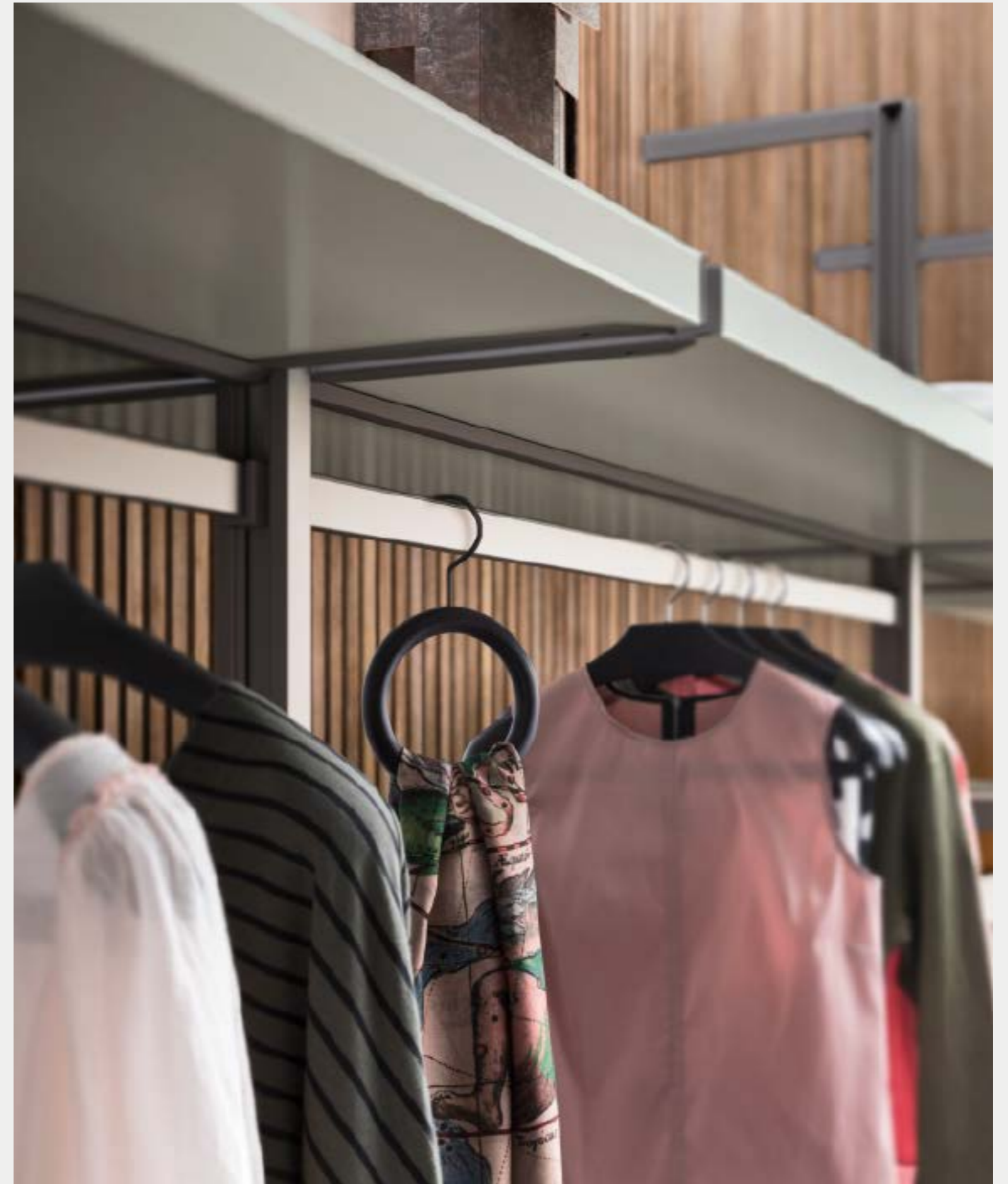

art direction
Bruna Vaccher
Genny Canton

graphic
Genny Canton Studio

photo (p. 24 - 33)
Paolo Contratti

styling (p. 24 - 33)
Rosanna Bignucolo

digital image
Nudesign

separations
Luce srl

print
Sincromia

stampato
Agosto 2021



Verifica le finiture disponibili sul nostro sito internet. / Check the finishes available on our website. / Consulte los acabados disponibles en nuestro sitio web. / Vérifiez les finitions disponibles sur notre site internet. / Überprüfen Sie auf unserer Webseite, ob die gewünschte Ausführung erhältlich ist. / Познакомьтесь с вариантами отделки на нашем интернет-сайте **www.alfdafre.it**

ALF UNO s.p.a. si riserva di apportare in qualsiasi momento modifiche a prodotti, misure e materiali, che ritenesse utili per esigenze di carattere produttivo e commerciale. Per essere sempre aggiornati vi invitiamo a consultare il nostro sito internet **www.alfdafre.it**.

LE FINITURE

I materiali utilizzati dalla nostra azienda sono selezionati tra i più affidabili per applicazione e resa estetica. Nonostante questo devono considerarsi tollerabili alcune differenze dovute alle caratteristiche stesse di materiali come essenze naturali, vetri, laccature e all'artigianalità di alcune fasi del processo produttivo che da sempre è un nostro valore aggiunto. Inoltre alcune finiture possono subire nel tempo maturazioni dovute all'azione della luce e del tempo. È importante quindi specificare se nell'ordine vi sono sostituzioni o completamenti per valutare insieme il miglior modo di procedere. Le tonalità di colore e le finiture illustrate vanno considerate puramente indicative. Verificare sempre la fattibilità dell'abbinamento finiture consultando l'interno del listino.

ALF UNO s.p.a. reserves the right to make any changes to products, measurements and materials at any time deemed useful for manufacturing and sales purposes. To stay up to date at all times, please visit our website **www.alfdafre.it**

FINISHES

The materials we use are selected among the most reliable products in terms of application and aesthetic rendering. Despite this, certain differences due to the very characteristics of materials such as natural wood finishes, glass and lacquers must be considered tolerable, as well as the hand-crafted nature of certain phases of the production process, which has always been one of our added values. In addition, some finishes may change over time, due to the effects of light and time. It is therefore important to specify whether there are replacements or completions in the order to assess the best way to proceed together. The finishes featured in this sample collection are purely indicative and are not available for all products. Please check in the price list if the finish is available for the chosen item. Orders will not be accepted for products with finishes not included in the price list. The colour shades and finishes illustrated herein are to be considered purely indicative. Always check the feasibility of finish combinations by consulting the price list contents.

