



MAGGIORAZIONE
SURCHARGE
+8%

listino 2023

TABLET

moderno

CONDIZIONI GENERALI DI VENDITA

DECORRENZA

Il presente listino sostituisce ed annulla tutti i precedenti.

Non costituisce offerta e può essere modificato, con comunicazione scritta dell'AZIENDA al Cliente, in qualsiasi momento anche senza preavviso.

Le modificazioni o gli aggiornamenti avranno efficacia rispetto a tutti gli ordinativi pervenuti o trasmessi all'AZIENDA dopo la comunicazione scritta di cui sopra.

PREZZI DI LISTINO E CONDIZIONI DI PAGAMENTO

I prezzi sono quotati al pubblico I.V.A. e contributo RAEE esclusi e si intendono franco fabbrica.

Decorso il termine contrattuale di pagamento l'AZIENDA è autorizzata alla emissione di tratte a saldo di ogni suo avere maggiorate degli interessi, spese e di ogni altro onere accessorio, previa comunicazione al Cliente. In caso di pagamento oltre i termini contrattuali, saranno addebitati gli interessi ai sensi del D.lgs. 231/2002, oltre al recupero di eventuali sconti espressamente concessi in ragione del termine di pagamento.

In caso di mancato pagamento nei tempi contrattuali l'AZIENDA potrà sospendere l'evasione degli ordini in corso previa comunicazione al Cliente.

CONSEGNA

I termini di consegna vengono computati in giorni lavorativi con decorrenza dal perfezionamento del contratto di vendita, che comunque si intende perfezionato entro 8 giorni dall'invio dell'ordine o comunque entro 8 giorni dall'ultimo chiarimento (se richiesto) fornito dal Cliente. I termini di consegna saranno prorogati automaticamente in dipendenza di avvenimenti non imputabili all'AZIENDA o a cause di forza maggiore. Sono sempre ammesse consegne parziali.

PRODOTTO

I dati tecnici relativi ai prodotti illustrati nel presente listino sono puramente indicativi come indicativi. L'AZIENDA si riserva la facoltà di apportare tutte le modifiche tecnico-costruttive migliorative del prodotto, senza obbligo di preavviso. La merce potrà tuttavia presentare caratteristiche parzialmente difformi da quelle indicate nel listino e nel catalogo, e comunque non risultare del tutto identica ai campioni che eventualmente fossero stati visionati in occasione della effettuazione dell'ordine, dovendosi riconoscere margini di tolleranza per quanto concerne i colori e le tonalità. La conformità al campione non deve intendersi in senso tassativo. Ciò vale anche per gli elettrodomestici o altri accessori impiegati a corredo delle cucine; questi potranno risultare esteticamente leggermente difformi in base alle marche utilizzate diverse da quelle da catalogo, salvo la sostanziale conformità delle caratteristiche e delle funzioni. Il Cliente potrà richiedere elementi specifici indicandone la marca sempre nell'ambito del ventaglio di offerte dell'AZIENDA non assume alcuna responsabilità circa la tenuta dei supporti che dipendesse da insufficienza della parete a cui venissero applicati gli stessi poiché la verifica dell'idoneità della parete dovrà essere effettuata dal cliente.

CONSISTENZA FINITURE

Le finiture potrebbero subire nel tempo modificazioni di colore dovute all'esposizione alla luce, al calore, ai vapori e all'invecchiamento. È, pertanto, naturale che in caso di successivi completamenti, si potranno avere delle differenze di tonalità che comunque dovrebbero tendere ad attenuarsi nel tempo. Per i piani in marmo e granito, considerando che il taglio proviene da BLOCCHI NATURALI, non possiamo garantire l'uniformità del colore e della grana. Questi fattori non potranno costituire motivo di contestazione o di resa del prodotto.

TRASPORTO

La merce non viaggia mai con mezzi dell'AZIENDA e, di conseguenza, nel momento in cui questa viene affidata al vettore, a prescindere da chi lo abbia incaricato, o caricata nel mezzo del cliente tutti i rischi passano al cliente stesso. Il Cliente, anche tramite suoi incaricati, ha l'obbligo di controllare l'integrità della merce all'arrivo ed, eventualmente, fare le dovute contestazioni scritte al Vettore. Qualora il danno rende inutilizzabile la merce è opportuno non ritirarla dandone conto nel Documento di Trasporto, diversamente con l'apposizione della firma da parte del Cliente, senza alcuna contestazione e/o rilievo si attesta la perfetta integrità e conformità della merce.

INSTALLAZIONE E IMPIEGO

L'AZIENDA declina ogni responsabilità per l'errata o impropria installazione del prodotto fornito (mobili, piani di lavoro, elettrodomestici, impianti elettrici o idraulici ecc.) siano essi di sua fabbricazione o di terzi, sempre che non provveda essa stessa alle predette operazioni. L'acquirente non potrà in nessun caso richiedere il risarcimento dei danni eventualmente causati in occasione dell'installazione. L'AZIENDA si ritiene esonerata da qualsiasi responsabilità circa il funzionamento degli elettrodomestici e degli accessori fabbricati da terzi costruttori, per i quali venga fornito dal predetto fabbricante lo specifico libretto di uso e manutenzione; nel libretto si troverà indicato l'eventuale Ufficio Reclami o i Centri di Assistenza del terzo fabbricante. Per l'impropria e/o inadeguata manutenzione, nonché per l'improprio e/o inadeguato utilizzo dei prodotti venduti, l'AZIENDA rinvia ogni e qualsiasi responsabilità e/o onere al Cliente o all'Utilizzatore.

RECLAMI ED AZIONI

I vizi e i difetti devono essere denunciati all'AZIENDA nei termini di legge. Anche nel caso di contestazione i pagamenti non potranno essere sospesi.

La merce rimarrà di proprietà dell'AZIENDA sino al pagamento totale da parte del committente.

GARANZIA

La garanzia sui prodotti venduti opererà per il tempo che, di volta in volta, le leggi vigenti nel Paese del Cliente stabiliranno come minimo a favore dell'acquirente.

RESTITUZIONE DI MERCE

La restituzione delle merci vendute si accetta solo se espressamente autorizzata dalla LUBE INDUSTRIES s.r.l.. Verranno concordate modalità di reintegro e di accredito, solo qualora la restituzione sia dovuta a fatti imputabili alla LUBE INDUSTRIES s.r.l.. La merce restituita dovrà essere consegnata in perfette condizioni e adeguatamente imballata. La merce da sostituire dovrà essere restituita senza ritardo dal commerciante alla fabbricante. Nel caso in cui detta merce sia restituita fino a sei mesi dalla sostituzione la fabbricante accrediterà al commerciante il cento per cento del valore della stessa; tra i sei e i nove mesi sarà accreditato al commerciante il settanta per cento del valore della merce; qualora la restituzione avvenga tra i nove ed i dodici mesi dalla sostituzione sarà accreditato al commerciante il cinquanta per cento del valore della merce; qualora la restituzione non sia compiuta nei dodici mesi non vi sarà accreditato nessun valore della merce sostituita.

SPESE

Per i pagamenti a mezzo tratte o ricevute bancarie verranno addebitati tutti gli oneri accessori alla riscossione.

CONTROVERSIE

Per ogni controversia il Foro competente sarà esclusivamente quello di Macerata.

EFFICACIA

Il Cliente, con il solo fatto di conferire l'ordinativo, si dichiara edotto ed accetta tutte le condizioni di vendita che precedono, salvo espresso patto contrario.

MARCHIO

Il marchio  è un marchio commerciale registrato, la proprietà dei diritti di utilizzazione economica appartengono esclusivamente a l'AZIENDA o a terzi, pertanto è espressamente vietato l'utilizzo senza il preventivo consenso scritto del proprietario. L'utilizzo del marchio da parte dei clienti ai fini pubblicitari dovrà comunque essere preventivamente autorizzato dall'AZIENDA previa presa visione del materiale prima della pubblicazione. In ogni caso il logo non potrà subire alcuna modifica od alterazione nelle forme e nei colori ne potrà essere associato a prezzi o scontistiche promozionali.

GENERAL SALES CONDITIONS

VALIDITY

This price list replaces and annuls all previous versions.

It does not constitute an offer and may be subject to change following a written notification by COMPANY to the Customer, at any time and without prior notice.

Any modifications or updates shall apply to all orders received by or transmitted to COMPANY following the above-mentioned written notification.

RETAIL PRICES AND PAYMENT TERMS

The retail prices quoted are exclusive of VAT and the WEEE fee and are ex works.

Upon expiry of the agreed payment term, COMPANY shall be authorised to issue bills of exchange for any outstanding amounts on every item, plus interest, expenses and any other additional liability, prior notification to the Customer. In the event of payment after the agreed term, accrued interest shall be charged in compliance with Italian Legislative Decree no. 231/2002, while any discounts expressly granted in relation to the payment terms shall be recovered.

If payment is not received within the agreed terms, COMPANY shall be entitled to suspend fulfilment of current orders, prior notification to the Customer.

DELIVERY

The delivery term is calculated in working days and takes effect from the date on which the sales contract is stipulated. In any case, the contract is considered effective within 8 days from order transmission or, at all events, within 8 days from the most recent clarification (if requested) provided by the Customer. The delivery term shall be automatically extended should any events occur that are not imputable to COMPANY or that are due to force majeure. Partial deliveries can always be effected.

THE PRODUCT

Any technical data relating to the products illustrated in this price list is purely indicative. The COMPANY reserves the right to effect any technical or structural modifications to improve the product, without prior notice. The goods may differ to some extent from the specifications given in the price list and the catalogue, or not be identical in all aspects to the samples viewed at the time of the order, since tolerances in relation to colours and tonalities are inevitable. Conformity with the samples is not obligatory. This right extends to household appliances or other kitchen furniture accessories; the appearance of the latter may differ slightly depending on the brand in question (which may differ from that shown in the catalogue), without prejudice to the basic conformity of features and functions. The Client may request specific components of a given brand from the range of products offered by the COMPANY, which is not liable in any way for the load bearing capacity of supports depending on the characteristics of the walls to which they are mounted; the Client alone is responsible for ensuring that the walls are able to support the load

CONSISTENCY OF THE FINISHES

The finishes may be subject to slight changes in colour over time as a result of exposure to light, heat, vapours and ageing. Therefore, in the event of completion orders, there may be shade differences that will tend to diminish over time. Regarding marble and granite worktops, we cannot guarantee uniformity of colour and vein pattern as the worktops are cut from NATURAL BLOCKS. These factors may not provide grounds for claims or return of products.

TRANSPORT

The goods never travel on vehicles owned by COMPANY; therefore, from the moment the goods are handed over to the forwarder and regardless of who entrusted the latter with the transport or loaded the goods into the customer's vehicle, all risks are transferred to the customer. The Customer - also through persons delegated by the latter - is obliged to check the integrity of the goods upon their arrival, and to notify written claims to the Forwarder. The Customer should not accept any damaged goods that are unsuitable for their intended use, and should notify the relevant claim on the transport document; otherwise, by signing the transport document without adding any claims and/or observations, the Customer certifies the integrity and conformity of the goods.

INSTALLATION AND USE

The COMPANY is not liable for incorrect or improper installation of the supplied product (units, tops, household appliances, electrical and plumbing systems, etc.), whether manufactured by the company or by third parties, unless the COMPANY itself does the installation. The purchaser may not claim for any damages caused during installation. Moreover, the COMPANY is not liable for the operation of household appliances and accessories manufactured by third parties, for which user and maintenance manuals are provided by the manufacturer in question; the manuals include information regarding the Claims Office or Technical Assistance Centres of the third party manufacturer. As regards improper and/or inadequate maintenance, or any improper and/or inadequate use of the products sold, the COMPANY transfers all liability and/or resulting costs to the Client or User.

CLAIMS

Any faults or defects must be reported to COMPANY within the terms specified by the law. Payment may not be suspended, even in the event of notification of claims.

The goods shall remain the property of COMPANY unless fully paid by customer.

WARRANTY

Warranty on sold products in favour of the purchaser shall apply for the minimum duration specified case-by-case by the laws in force in the Customer's country.

RETURN OF GOODS

Return of sold goods is only accepted if expressly authorised by LUBE INDUSTRIES s.r.l.. Replacement or reimbursement of said goods shall be mutually denied only if the goods return is due to events imputable to LUBE INDUSTRIES s.r.l.. The returned goods must be delivered in perfect conditions and suitably packaged.

The goods to be replaced must be returned from the retailer to the producer without delay. In the case that the goods are returned until six months after replacing the producer will credit the retailer 100% of the replaced goods value; between six and nine months after replacing, the producer will credit the retailer 70% of the replaced goods value; if the return is between nine and twelve months after the replacement, will be credited to the retailer 50% of the replaced goods value; if the refund is not made within twelve months will not be credited any of the replaced goods value.

EXPENSES

For payments effected through bill of exchange or cash order, all additional collection expenses shall be charged.

DISPUTES

The Court of Macerata shall have sole jurisdiction for any disputes that may arise.

EFFECTIVENESS

For the sole fact of conferring the order, the Customer declares to be informed and accepts all the aforementioned sale conditions, unless otherwise expressly agreed on.

BRAND

The trademark  is registered; the right of the commercial exploitation belongs only to the COMPANY or a third party, and the trademark may not be used without the owner's written consent. The client may only use the trademark for reasons of publicity if authorised in advance by COMPANY, following review of the material before publication.

In any case, the logo may not be modified or altered in form or colour, nor may it be associated with promotional prices or discounts.

INFORMAZIONI TECNICHE

TECHNICAL INFORMATION

Le misure indicate nel presente listino sono espresse in cm.

Le profondità delle basi si intendono comprensive di top.

Le profondità dei pensili e delle colonne si intendono comprensive di ante.

Le altezze delle basi e delle colonne si intendono comprensive di zoccolo

Il verso degli elementi è individuato dalla posizione delle cerniere. Fanno eccezione solo l'angolo base e la colonna ad angolo dove il verso viene individuato dalla posizione dell'anta rispetto al mobile.

Per gli elementi con il verso, è stato inserito il codice con entrambi i versi (ad esempio una base da cm 45 cod. E4010451/2).

Sarà quindi necessario specificare se l'ultima cifra dovrà essere "1" per il verso destro cioè E4010451 oppure "2" per il verso sinistro cioè E4010452.

Per i lavelli il verso dx o sx è individuato dalla posizione delle vasche.

I prezzi indicati sono espressi all'unità di euro e sono IVA e contributo RAEE esclusi

I prezzi delle basi e delle colonne sono comprensivi dello zoccolo standard.

Per tutti i mobili fuori misura ha valore il listino riportato nella pagina maggiorazioni fuori misura.

Nel caso vengano richieste maniglie con passo diverso da quello previsto dal modello, le ante verranno fornite senza fori maniglia.

I colori delle immagini riportate nel presente listino sono solamente indicativi e non possono essere utilizzati come riferimento.

The measurements appearing in this price list are expressed in cm.

The depths of base units are inclusive of the worktop.

The depths of the wall units and columns are inclusive of the doors.

The heights of the base units and columns are inclusive of the plinth.

The direction of the elements is determined by the position of the hinges. The only exceptions are the corner base unit and corner column, where the direction is determined by the position of the door in relation to the cabinet.

For elements that come with a direction, the code includes both directions (e.g. 45 cm base unit - code E4010451/2).

It is therefore necessary to specify the last figure - "1" for the RH direction, i.e. E4010451, or "2" for the LH direction, i.e. E4010452.

The RH or LH direction of the sinks is determined by the position of the bowls.

The prices indicated are expressed in units of Euro and exclude VAT and the WEEE fee.

Prices of the base units and columns are inclusive of the standard plinth.

The prices that apply to all custom-sized cabinets are indicated on the page "Surcharges for custom-sized elements".

In the event of handles requested with a different centre-to-centre distance compared to the standard for the model, the doors will be supplied without pre-drilled holes for the handles.

The colours in the pictures appearing in this price list are purely indicative and should not be used as reference.

COMPOSIZIONI SENZA ELETTRODOMESTICI E SENZA TOP

COMPOSITIONS WITHOUT HOUSEHOLD APPLIANCES AND WORKTOP

Tutte le composizioni richieste prive di elettrodomestici (frigo, forno, piano cottura, lavastoviglie o lavatrice), saranno aumentate di un importo netto pari a € 150 iva esclusa. Tale direttiva non si applica se la cucina contiene almeno due di questi elettrodomestici.

Tutte le composizioni richieste prive di top, saranno aumentate di un importo netto pari a € 100 iva esclusa.

All compositions requested without household appliances (fridge, oven, cooker hob, dishwasher or washing machine) shall be subject to a price increase of € 150 VAT excluded.

This measure does not apply if the kitchen contains at least two of the above-mentioned appliances.

All compositions requested without worktop shall be subject to a price increase of € 100 VAT excluded.

ELEMENTI FUORI MISURA

CUSTOM-SIZED ELEMENTS

MODELLI MODELS	MODIFICABILE IN LARGHEZZA WIDTH ADJUSTABLE	MODIFICABILE IN ALTEZZA HEIGHT ADJUSTABLE
TABLET NECK	SI YES	SI YES
TABLET BRIDGE	SI YES	SI YES
TABLET HEAD	NO NOT	SI YES
TABLET ANTE VETRO GLASS DOOR	NO NOT	NO NOT

L'AZIENDA si riserva di accettare o meno la realizzazione di fuori misura di notevole difficoltà tecnica, previo invio di un disegno e successiva autorizzazione del ns. ufficio tecnico. Il prezzo di tali fuori misura sarà stabilito di volta in volta. Si intende che gli elementi fuori misura realizzati su Vs. richiesta, non saranno oggetto di ritiro.

COMPANY reserves the right to accept or decline processing of custom-sized elements that imply significant technical difficulties, subject to transmission of the drawing and subsequent authorisation by our Technical Dept. The price of these custom-sized elements shall be defined case-by-case. Any custom-sized elements manufactured on your request shall not be collected in the event of claims.

MAGGIORAZIONI PER ELEMENTI FUORI MISURA

SURCHARGES FOR CUSTOM-SIZED ELEMENTS

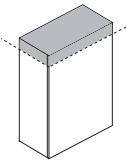
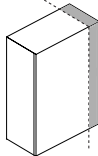
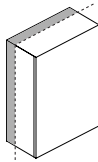
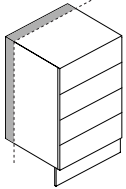
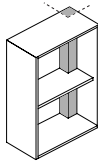
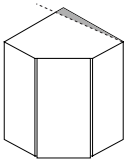
	DESCRIZIONE DESCRIPTION	MAGGIORAZIONE SURCHARGE		DESCRIZIONE DESCRIPTION	MAGGIORAZIONE SURCHARGE
	Riduzioni in altezza Height reduction			Basi angolo fuori squadra Out-of-plumb corner base units	
		Basi Base units + 25 %			
		Pensili Wall units + 25 %			
		Colonne Columns + 25 %			+ 28 %
	Riduzioni in larghezza Width reduction N.B.: non realizzabile per la versione Head Note: not feasible for Head version			Basi e sottolavelli con portabombola Base and sink base units with cylinder holder	
		Basi Base units + 28 %			
		Pensili Wall units + 28 %			
		Colonne Columns + 28 %			+ 20 €
	Riduzioni in profondità Depth reduction			Maggiorazioni per fianco scavato per inserimento piano cottura tra due basi (PPC opz. 011/012) Surcharge for digged side to insert cooking hob between two bases (PPC opt. 011/012)	
		Basi Base units + 18 %			
		Pensili Wall units + 18 %			
		Colonne Columns + 18 %			Cadauno each + 23 €
	Riduzioni per cassettera N.B.: modificabili solo in profondità fino a 31 cm al fianco Reductions for drawer unit Note: can only be modified depth-wise up to 31 cm on the side			Maggiorazioni per raggiatura mensola in laminato Surcharges for rounded edge on laminate shelf	
					Codice code T9STP + 38 €
	Taglio per pilastro N.B.: non realizzabile nei pensili con meccanismi Indent for pilaster Note: not feasible on wall units with mechanisms			Maggiorazione per inserimento tubo cappa (da sommare al prezzo del pensile) Surcharge for insertion of the hood pipe (to be added to the price of the wall unit)	
		Basi Base units Cod. T9SCB + 90 €			
		Pensili Wall units Cod. T9SCB + 90 €			
		Colonne Columns Cod. T9SCC + 130 €			+ 90 €
	Pensili angolo fuori squadra Out-of-plumb corner wall units			Maggiorazione per inserimento cappa non standard N.B.: verificare sempre la fattibilità dell'incasso con il nostro ufficio tecnico Surcharge for the insertion of a non-standard hood Note: always verify the feasibility of the installation	
					+ 28 %
					+ 90 €

La maggiorazione è da applicare al prezzo dell'elemento di serie più grande rispetto a quello delle dimensioni richieste.

Negli elementi fuori misura per motivi di lavorazione, l'estetica può risultare inferiore agli elementi di serie.

The surcharge applies to the price of the standard element that is next largest to that of the requested size.

Due to the processing involved, the aesthetic level of custom-sized elements may be slightly inferior to that of standard elements.

tablet

Superfici lisce e levigate, colori di tendenza sono gli ingredienti di Tablet, la cucina di ultima generazione di Creo Kitchens. Caratteristiche che si aggiungono alla qualità e al design Made in Italy, così ammirato in tutto il mondo.

Tablet è studiata per essere “cucita” sulle proprie esigenze di spazio e di stile, è tanto versatile e personalizzabile da diventare unica ed offrire una soluzione compositiva perfetta, con un’attenzione particolare al prezzo, sorprendente per la sua competitività.

Infinite le combinazioni, tantissime le nuove tonalità sia per le versioni Bridge e Head con maniglia che per la versione Neck con gola. Il vetro flutes e il vetro satinato sulle ante conferiscono alla cucina leggerezza e luminosità. Lineare, moderna, raffinata, allegra, rassicurante, amabile, informale, imprevedibile: sono tanti gli aggettivi per definire l’identità di Tablet, che varia a seconda della sua configurazione e dei colori scelti.

Di base rimangono la sua funzionalità e la cura dei dettagli. Nuovi accessori la impreziosiscono e la rendono ancora più pratica.

È facile innamorarsi di una cucina Tablet: semplicemente elegante, esteticamente essenziale, il piacere di vivere nell’ambiente più confortevole che c’è: la propria casa.





CREO ECOLOGIC

IL GRUPPO LUBE HA SCELTO DI UTILIZZARE PER I COMPONENTI COSTITUENTI LE STRUTTURE DELLE CUCINE SOLO MATERIALE A BASSISSIMA EMISSIONE DI FORMALDEIDE: CONFORMI ALLO STANDARD F4STELLE SECONDO LA NORMA JIS, CERTIFICATO DAL MINISTERO GIAPPONESE, IL PIU' SEVERO IN MERITO ALLE NORMATIVE DI SALVAGUARDIA AMBIENTALE.

Regarding the production of its kitchen structure components, lube group has decided to only use materials featuring very low formaldehyde emissions complying with the 4-star standard, as defined by the jis regulation. This standard is certified by the japanese government-the most rigorous when it comes to environmental protection.

Smooth sanded surfaces and trendy colours are the ingredients of Tablet, the new generation kitchen from Creo Kitchens. These properties are combined with the quality of Italian design, admired all over the world. Tablet is designed to be “tailored” to your requirements in terms of space and style. It is versatile and customisable enough to offer unique and perfect compositional solutions. It is also very keenly priced and surprisingly competitive.

Infinite combinations, loads of new colours, both for Bridge and Head versions with handles and the Neck version with finger rail. Fluted and satin-finish glass on the doors add lightness and luminosity to the kitchen. Linear, modern, refined, jolly, reassuring, lovable, informal, unpredictable: there are many adjectives you could use to define Tablet, which varies according to the configuration and colours selected.

What remains constant is the functionality and attention to detail. New accessories make it more beautiful and even more practical.

It's easy to fall in love with a Tablet kitchen: simply elegant and minimalist, the pleasure of living in the most comfortable environment there is: your own home.



T A B L E T W O O D

La forma di Tablet, la sostanza del legno, una tecnologia innovativa.

In una cucina unica.

The form of Tablet, the substance of wood, an innovative technology.

In a unique kitchen.



tablet impiallacciato

Neck cod. **KT4**
Bridge cod. **KT0**
Head cod. **KT7**

SP. 18 MM

N.B.: i prezzi sono espressi all'unità di euro (iva esclusa)

CARATTERISTICHE TECNICHE

ANTE E FRONTALI CASSETTI

anta sp.18 mm costituita da un pannello di particelle di legno (conforme **US EPA TSCA Title VI**) impiallacciato rovere tinto a poro aperto fiamma verticale * **WOOD** con bordo polipropilene* 10/10 in tinta nei colori : rovere moscato (opz.5444), rovere fumè (opz.5445), rovere grey (opz.5443), rovere naturale (opz.5442)

anta sp.18 mm costituita da un pannello di particelle di legno (conforme **US EPA TSCA Title VI**) impiallacciato rovere laccato a poro aperto fiamma verticale * **WOOD** con bordo polipropilene* 10/10 in tinta nei colori : rovere bianco (opz.5441), rovere nero (opz.5446)

* **WOOD** proprietà tecniche:

Le ante impiallacciate WOOD sono costituite da un pannello di particelle di legno impiallacciato rovere sottoposto a un processo di verniciatura trasparente attraverso la tecnologia "ECCIMERI". Tale trattamento conferisce alle ante una superficie ULTRA OPACA (circa 5 gloss), con effetto SOFT-TOUCH e una maggiore resistenza al graffio.

La parte posteriore dell'anta non è soggetta al trattamento sopraindicato, viene rivestita con impiallaccio in tinta ma con caratteristiche differenti rispetto al frontale.



* **Tecnologia produttiva di elevata qualità trasmette al bordo un'alta resistenza ai prodotti acidi, solventi e raggi UV. Inoltre è un prodotto ecologico**

STRUTTURE

ANTA: rovere bianco
di serie : nobilitato bianco (opz.001) schiena e ripiano bianco (opz.001)

ANTE: rovere naturale, rovere grey, rovere moscato
di serie : nobilitato visone (opz.948M) schiena e ripiano visone (opz.948M)

ANTE: rovere fumè, rovere nero
di serie : nobilitato lavagna (opz.9620) schiena e ripiano lavagna (opz.9620)

PROFILO E GOLA VERSIONE **NECK**

anta squadrata senza profilo con gola "ELLE"



N.B.: per le finiture gole vedi listino pag.27

MANIGLIE

vedi pag.32-33-34

MENSOLE COME STRUTTURE

vedi pag.36

MENSOLE COME ANTE

vedi pag.36-37

ZOCCOLI

vedi pag.37

tablet veneered

Neck cod. **KT4**
Bridge cod. **KT0**
Head cod. **KT7**

TH. 18 MM

Note: the prices are expressed in units of euro (vat excluded)

TECHNICAL FEATURES

DOORS AND DRAWER FRONTS

18 mm th. door made of a panel in open-pore of vertical flame stained oak veneered wood particles (US EPA TSCA Title VI compliant) * **WOOD** with 10/10 polypropylene* edge available in the following colours: muscat oak (opt. 5444), smoked oak (opt. 5445), grey oak (opt. 5443), natural oak (opt. 5442)

18 mm th. door made of a panel in open-pore of vertical flame lacquered oak veneered wood particles (US EPA TSCA Title VI compliant) * **WOOD** with 10/10 polypropylene* edge available in the following colours: white oak (opt. 5441), black oak (opt. 5446)

* **WOOD** technical specifications:

The **WOOD** veneered door is a panel of oak veneered wood particles subjected to a transparent painting process using the "**ECCIMERI**" technology.

This treatment gives the doors an **ULTRA MATT** surface (about 5 gloss), with a **SOFT-TOUCH** effect and a greater scratch resistance.

The rear part of the door is not subject to the above treatment, it is covered with matching veneer wood that has different characteristics than the front.



* High quality manufacturing technology, gives the edging a high level of resistance to acids, solvents and UV rays. It is also an ecological product.

CARCASSES

DOOR: white oak

standard: melamine-coated white (opt.001), white back panel and shelf (opt.001)

DOORS: natural oak, gray oak, muscat oak

standard: melamine-coated mink (opt.948M), mink back panel and shelf (opt.948M)

DOORS: smoked oak, black oak

standard: melamine-coated slate grey (opt.9620) back panel and shelf slate grey (opt.9620)

PROFILE AND FINGER RAIL **NECK** VERSION

square door without profile with "L" shaped finger rail



NOTE: for finger rail finishes see price list at page 27

HANDLES

see page 32-33-34

SHELVES WITH CARCASSES

see page 36

SHELVES WITH DOORS

see page 36-37

PLINTHS

see page 37

tablet impiallacciato veneered

Neck cod. **KT4**
 Bridge cod. **KT0**
 Head cod. **KT7**

SP. 18 MM TH. 18 MM

ante finitura impiallacciata rovere tinto a poro aperto
 doors with open pore stained oak veneered finish



rovere naturale (opz.5442),
 fiamma verticale
 natural oak (opt.5442),
 vertical grain

rovere grey (opz.5443),
 fiamma verticale
 grey oak (opt.5443),
 vertical grain

rovere moscato (opz.5444),
 fiamma verticale
 muscat oak (opt.5444),
 vertical grain

rovere fumè (opz.5445),
 fiamma verticale
 smoked oak (opt.5445),
 vertical grain

ante finitura impiallacciata rovere laccato a poro aperto
 doors with open pore lacquered veneered finish

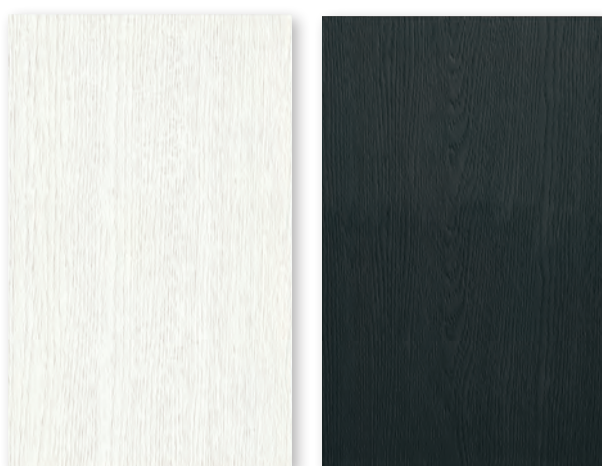

rovere bianco (opz.5441),
 fiamma verticale
 white oak (opt.5441),
 vertical grain

rovere nero (opz.5446),
 fiamma verticale
 black oak (opt.5446),
 vertical grain

SP. 18 MM TH. 18 MM

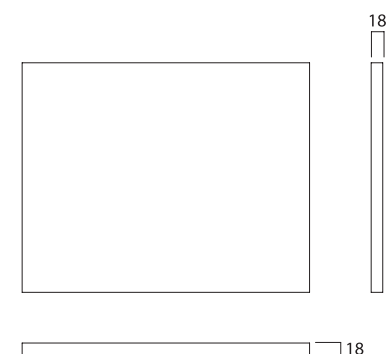

tablet melaminico

Neck cod. **KT5**
Bridge cod. **KT1**
Head cod. **KT8**

SP. 18 MM

N.B.: i prezzi sono espressi all'unità di euro (iva esclusa)

CARATTERISTICHE TECNICHE

ANTE E FRONTALI CASSETTI	<p>anta sp.18 mm in melaminico finitura opaca effetto legno venatura verticale bordata in tinta nei colori: rovere luna (opz.5316), rovere dark (opz.5318), rovere arizona (opz.5317), rovere venere (opz.5315), frassino lava (opz.2408), frassino sabbia (opz.2406), frassino pietra (opz.2407)</p> <p>anta sp.18 mm in melaminico finitura semilucida effetto legno venatura verticale bordata in tinta nel colore: noce brown (opz.2371)</p> <p>anta sp.18 mm in melaminico finitura materica effetto legno venatura verticale bordata in tinta nei colori: rovere tabià (opz.5309), rovere ortisei (opz.5305)</p> <p>anta sp.18 mm in melaminico finitura opaca tinta unita con retro a colore bordata in tinta nei colori: bianco (opz.7447N), porcellana (opz.7703N), desert (opz.8914N), molara (opz.9636N), arena (opz.9637N)</p> <p>anta sp.18 mm in melaminico finitura ovattata nel colore: rosse cardinale (opz.8123)</p> <p>anta sp.18 mm in melaminico finitura cemento bordata in tinta nei colori: bianco (opz.9639), bronzo (opz.8866), ardesia (opz.9638)</p> <p>anta sp.18 mm in melaminico finitura opaca marmorizzata nel colore: trani (opz.7704)</p> <p>anta sp.18 mm in melaminico finitura opaca tinta unita con retro a colore e bordo ABS multistrato nei colori: bianco (opz.7447P), porcellana (opz.7703P), desert (opz.8914P), molara (opz.9636P), arena (opz.9637P)</p>
ANTE VETRO	<p>di serie: telaio in alluminio finitura brill sp.18 mm, vetro satinato sp.4 mm, senza maniglia telaio in alluminio finitura titanio sp.18 mm, vetro bronzo sp.4 mm, senza maniglia</p> <p>a richiesta: telaio in alluminio finitura grigio selce sp.18 mm, vetro bronzo sp.4 mm, senza maniglia telaio in alluminio finitura silver dark sp.18 mm, vetro fumè sp.4 mm, senza maniglia telaio sp.18 mm con montanti in melaminico finitura opaca effetto legno e traversi in alluminio verniciato a colore come le tinte unite melaminico, vetro flutes sp.4 mm, senza maniglia</p>
PROFILO E GOLLA VERSIONE NECK	<p>anta squadrata con gola a "ELLE"</p> <p>N.B.: per le finiture gole vedi listino pag.27</p> 
MANIGLIE	<p>vedi pag.32-33-34</p>
STRUTTURE	<p>ANTE: ROVERE VENERE, BIANCO, BIANCO EFFETTO CEMENTO nobilitato bianco (opz.001), schiena e ripiano bianco (opz.001)</p> <p>ANTE: ROVERE LUNA, ARENA, FRASSINO SABBIA, ROVERE ORTISEI, ROSSO CARDINALE nobilitato visone (opz.948M), schiena e ripiano visone (opz.948M)</p> <p>ANTE: ROVERE DARK, ROVERE ARIZONA, BRONZO EFFETTO CEMENTO, FRASSINO PIETRA, NOCE BROWN, ROVERE TABIÀ nobilitato fango (opz.8860), schiena e ripiano fango (opz.8860)</p> <p>ANTE: FRASSINO LAVA, ARDESIA EFFETTO CEMENTO nobilitato lavagna (opz.9620), schiena e ripiano lavagna (opz.9620)</p> <p>ANTE: PORCELLANA, DESERT, MOLARA, TRANI nobilitato conchiglia (opz.8910), schiena e ripiano conchiglia (opz.8910)</p>
MENSOLE	<p>di serie: altezza 3,8 cm in nobilitato bianco (opz.001), visone (opz.948M), fango (opz.8860), lavagna (opz.9620), conchiglia (opz.8910)</p> <p>a richiesta: altezza 3,8 cm in melaminico: ante effetto legno, ante tinta unita, ante tinta unita bordo ABS multistrato altezza 3,8 cm laccate UV lucide e opache bordo in tinta altezza 3,8 cm impialacciate wood bordo in tinta</p>
ZOCCOLI	<p>di serie: altezza 13 cm in pvc ricoperti in melamina finitura acciaio (opz.407), alluminio satinato (opz.405), bianco (opz.001)</p> <p>a richiesta: altezza 13 cm in alluminio finitura brill (opz.412), titanio ossidato (opz.414), vedi maggiorazioni pag.37 altezza 13 cm in alluminio verniciato a polvere finitura opaca nei colori vedi pag.37</p>



tablet melamine

Neck cod. **KT5**
Bridge cod. **KT1**
Head cod. **KT8**

TH. 18 MM

Note: the prices are expressed in units of euro (vat excluded)

TECHNICAL SPECIFICATIONS

DOORS AND DRAWER FRONTS

door 18 mm thick in melamine with wood-effect matt finish with vertical grain with matching edge in the following colours: moon oak (opt.5316), dark oak (opt.5318), Arizona oak (opt.5317), Venus oak (opt.5315), lava ash (opt.2408), sand ash (opt.2406), stone ash (opt.2407)

door 18 mm thick in melamine with wood-effect semi-gloss finish with vertical grain with matching edge in the following colour: brown walnut (opt.2371)

door 18 mm thick in melamine with wood-effect textured finish with vertical grain with matching edge in the following colours: tabià oak (opt.5309), ortisei oak (opt.5305)

door 18 mm thick in melamine with solid colour matt finish with matching rear and edge in the following colours: white (opt.7447N), porcelain (opt.7703N), desert (opt.8914N), molarà (opt.9636N), arena (opt.9637N)

door 18 mm thick in melamine with wadding finish in the colour: cardinal red (opt.8123)

door 18 mm thick in melamine with cement finish with matching edge in the following colours: white (opt.9639), bronze (opt.8866), slate grey (opt.9638)

door 18 mm thick in melamine with matt marble effect finish in the colour: trani (opt.7704)

door 18 mm thick in melamine with solid colour matt finish with matching rear and ABS ply edge in the following colours: white (opt.7447P), porcelain (opt.7703P), desert (opt.8914P), molarà (opt.9636P), arena (opt.9637P)

GLASS DOORS

standard: 18 mm thick aluminium frame with brill finish, 4 mm thick frosted glass, without handle
18 mm thick aluminium frame with titanium finish, 4 mm thick bronze glass, without handle

on request: 18 mm thick aluminium frame with flint grey finish, 4 mm thick frosted glass, without handle
18 mm thick aluminium frame with dark silver finish, 4 mm thick bronze glass, without handle

18 mm thick frame with uprights in melamine with wood-effect matt finish and crossbars in aluminium painted to match as with the solid colour melamine, fluted glass 4 mm thick, without handle

NECK VERSION

PROFILE AND FINGER RAIL

square door with "L" shaped finger rail

NOTE: for finger rail finishes see price list at page 27



HANDLES

see page 32-33-34

STRUCTURES

DOORS: VENUS OAK, WHITE, CEMENT EFFECT WHITE

white chipboard (opt. 001), white back panel and shelf (opt. 001)

DOORS: MOON OAK, ARENA, SAND ASH, ORTISEI OAK, CARDINAL RED

mink chipboard (opt. 948M), mink back panel and shelf (opt. 948M)

DOORS: DARK OAK, ARIZONA OAK, CEMENT EFFECT BRONZE, STONE ASH, BROWN WALNUT, TABIÀ OAK

mud chipboard (opt. 8860), mud back panel and shelf (opt. 8860)

DOORS: LAVA ASH, CEMENT-EFFECT SLATE GREY

slateboard grey chipboard (opt. 9620), slateboard grey back panel and shelf (opt. 9620)

DOORS: PORCELAIN, DESERT, MOLARA, TRANI

shell chipboard (opt. 8910), shell back panel and shelf (opt. 8910)

SHELVES

standard: height 3.8 cm in white (opt.001), mink (opt.948M), mud (opt.8860), slateboard grey (opt.9620), shell (opt.8910)

on request: height 3.8 cm in melamine to match: wood-effect doors, solid colour doors, solid colour doors with ABS ply edges
height 3.8 cm glossy and matt UV lacquer with matching edge
height 3.8 cm wood veneer with matching edge

PLINTHS

standard: height 13 cm, melamine-faced PVC with steel finish (opt. 407), satin aluminium (opt.405), white (opt.001)

on request: height 13 cm, in aluminium with brill finish (opt. 412) oxidised titanium (opt. 414), see surcharges on page 37

height 13 cm, in matt powder-coated aluminium in the following colours see page 37

tablet melaminico melamine

Neck cod. **KT5**
 Bridge cod. **KT1**
 Head cod. **KT8**

ante effetto legno finitura opaca fiamma verticale
 wood-effect doors with matt finish and vertical grain

 *colori in pronta consegna*
available colours



rovere luna (opz.5316)
 moon oak (opt.5316)



rovere venere (opz.5315)
 venus oak (opt.5315)



rovere arizona (opz.5317)
 arizona oak (opt.5317)



rovere dark (opz.5318)
 dark oak (opt.5318)



frassino lava (opz.2408)
 lava ash (opt.2408)



frassino sabbia (opz.2406)
 sand ash (opt.2406)



frassino pietra (opz.2407)
 stone ash (opt.2407)

ante effetto legno finitura semilucida fiamma verticale
 wood-effect doors with semi-gloss finish and vertical grain



noce brown (opz.2371)
 brown walnut (opt.2371)

SP. 18 MM TH. 18 MM

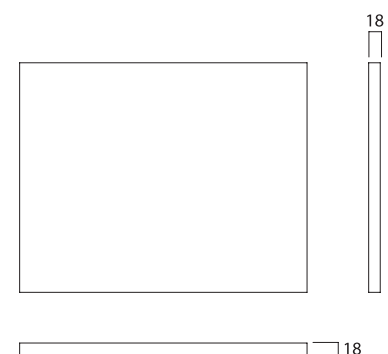

tablet melaminico melamine

Neck cod. **KT5**
Bridge cod. **KT1**
Head cod. **KT8**

ante tinta unita finitura opaca
solid colour doors with matt finish

 *colori in pronta consegna
available colours*

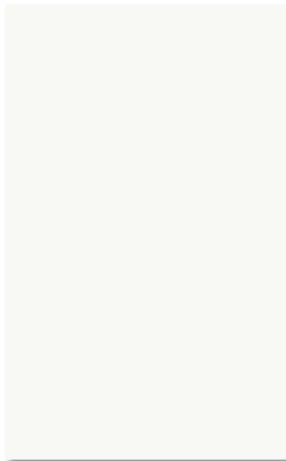

bianco (opz.7447N)
white (opt.7447N)

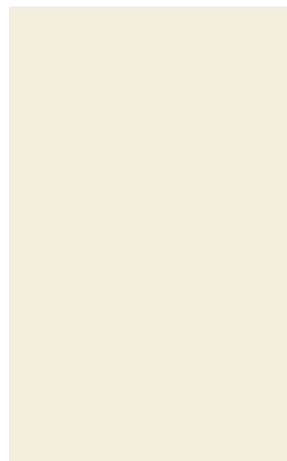

porcellana
(opz.7703N)
porcelain (opt.7703N)

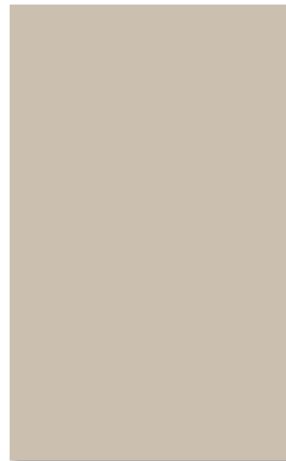

desert (opz.8914N)
desert (opt.8914N)



molara (opz.9636N)
molara (opt.9636N)



arena (opz.9637N)
arena (opt.9637N)

ante effetto cemento finitura opaca
cement-effect doors in matt finish

 *colori in pronta consegna
available colours*



bianco (opz.9639)
white (opt.9639)



bronzo (opz.8866)
bronze (opt.8866)



ardesia (opz.9638)
slate grey (opt.9638)

SP. 18 MM TH. 18 MM

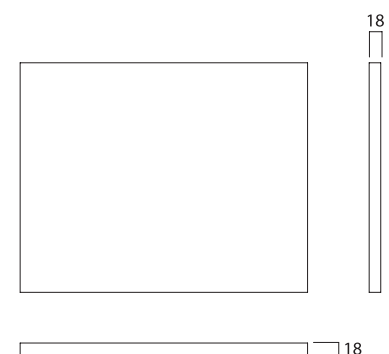

tablet melaminico melamine

Neck cod. **KT5**
Bridge cod. **KT1**
Head cod. **KT8**

ante finitura materica fiamma verticale **NEW**
doors with textured finish vertical flame

 *colori in pronta consegna
available colours*



rovere tabià (opz.5309)
tabià oak (opt.5309)



rovere ortisei (opz.5305)
ortisei oak (opt.5305)

anta finitura opaca marmorizzata **NEW**
door with matt marble effect finish

 *colori in pronta consegna
available colours*



trani (opz.7704)
trani (opt.7704)

SP. 18 MM TH. 18 MM

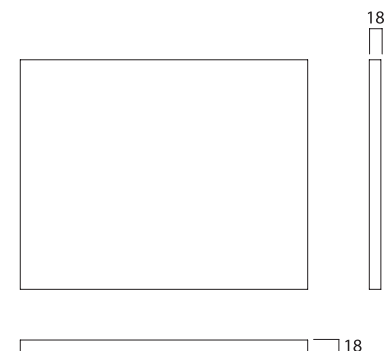

tablet melaminico melamine

Neck cod. **KT5**
Bridge cod. **KT1**
Head cod. **KT8**

ante finitura ovatta **NEW**
doors with wadding finish

 *colori in pronta consegna*
available colours



rosso cardinale (opz.8123)
cardinal red (opt.8123)

SP. 18 MM TH. 18 MM

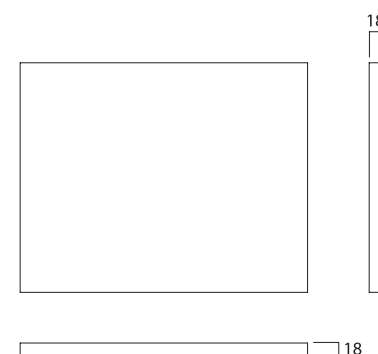

tablet

Neck cod. **KT5**

Bridge cod. **KT1**

Head cod. **KT8**

melaminico bordo **ABS multistrato** melamine ABS ply edge

ante tinta unita finitura opaca bordo ABS multistrato
solid colour doors with matt finish and ABS ply edge

 *colori in pronta consegna
available colours*

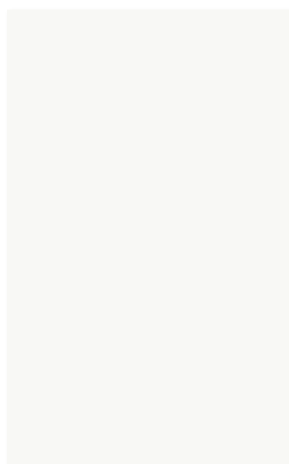

bianco (opz.7447P)
white (opt.7447P)

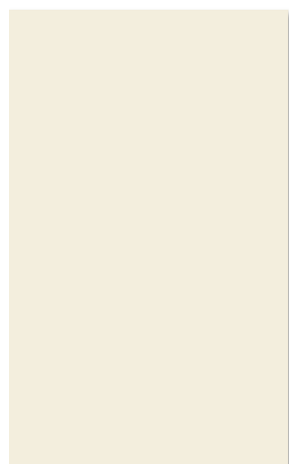

porcellana (opz.7703P)
porcelain (opt.7703P)

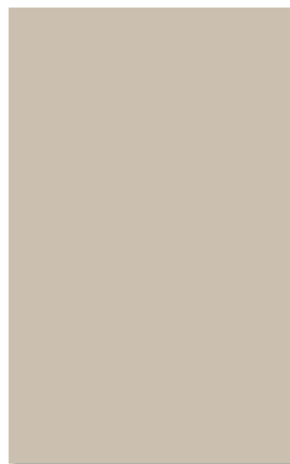

desert (opz.8914P)
desert (opt.8914P)



molara (opz.9636P)
molara (opt.9636P)



arena (opz.9637P)
arena (opt.9637P)

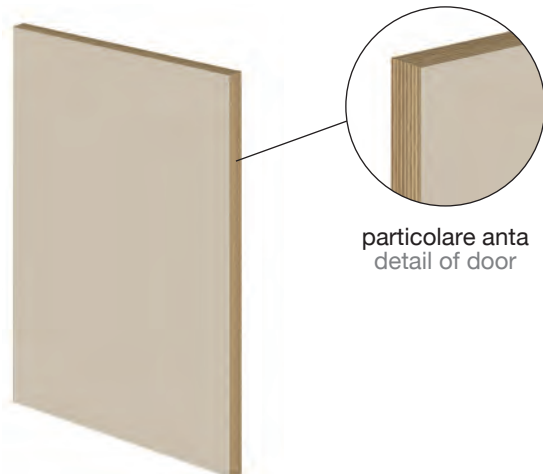

particolare anta
detail of door

anta bordo ABS multistrato
ABS ply edge door

SP. 18 MM TH. 18 MM

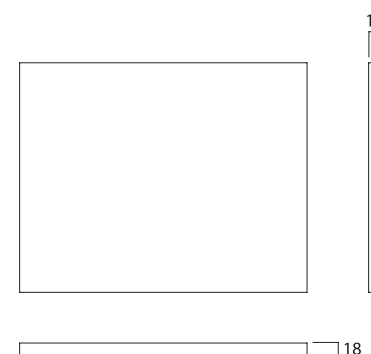



tablet laccato

Neck cod. **KT6**
Bridge cod. **KT2**
Head cod. **KT9**

SP. 18 MM

N.B.: i prezzi sono espressi all'unità di euro (iva esclusa)

CARATTERISTICHE TECNICHE

ANTE E FRONTALI CASSETTI

anta sp.18 mm con pannello in MDF (conforme **US EPA TSCA Title VI**) fronte esterno laccato superopaco (2 gloss) ciclo di verniciatura a raggi UV, retro melaminico abbinato alla parte frontale bordato in 4 lati polipropilene* nei colori opachi: bianco (opz.7405), antracite (opz.9558), desert (opz.8941), nero (opz.7895), blu cobalto (opz.8383), bianco neve (opz.7407), verde malga (opz.8477), polvere (opz.9529), rosso velvet (opz.8168), grigio minerale (opz.9523), beige colorado (opz.7777), rosso cammeo (opz.8160), giallo cadmio (opz.8255), verde nilo (opz.8475)

anta sp.18 mm con pannello in MDF (conforme **US EPA TSCA Title VI**) fronte esterno laccato extralucido (92 gloss) ciclo di verniciatura a raggi UV, retro melaminico abbinato alla parte frontale bordato in 4 lati polipropilene* nei colori lucido: bianco (opz.7406), antracite (opz.9559), polvere (opz.9530), nero (opz.7896), desert (opz.8942), beige colorado (opz.7778), rosso cammeo (opz.8164), grigio minerale (opz.9524)



* **Tecnologia produttiva di elevata qualità trasmette al bordo un'alta resistenza ai prodotti acidi, solventi e raggi UV. Inoltre è un prodotto ecologico**

MANUTENZIONE E PULIZIA

Si consiglia di utilizzare un panno in microfibra inumidito con acqua e sapone neutro.

È vietato l'utilizzo dei prodotti contenenti: ammoniaca, alcool, candeggina o abrasivi.

Devono essere evitati anche i detergenti aggressivi tipo sgrassanti o simili, perchè possono danneggiare la superficie verniciata.

ANTE VETRO

di serie: telaio in alluminio finitura brill sp.18 mm, vetro satinato sp.4 mm, senza maniglia
telaio in alluminio finitura titanio sp.18 mm, vetro bronzo sp.4 mm, senza maniglia

a richiesta: telaio in alluminio finitura grigio selce sp.18 mm, vetro bronzo sp.4 mm, senza maniglia
telaio in alluminio finitura silver dark sp.18 mm, vetro fumè sp.4 mm, senza maniglia

PROFILO E GOLA VERSIONE **NECK**

anta squadrata con gola a "ELLE"

N.B.: per le finiture gole vedi listino pag.27



MANIGLIE

vedi pag.32-33-34

STRUTTURE

ANTE: bianco, verde nilo
nobilitato bianco (opz.001) schiena e ripiano bianco (opz.001)

ANTE: verde malga, desert, giallo cadmio, rosso cammeo
nobilitato conchiglia (opz.8910) schiena e ripiano conchiglia (opz.8910)

ANTE: bianco neve, beige colorado, rosso velvet
nobilitato visone (opz.948M) schiena e ripiano visone (opz.948M)

ANTE: antracite, nero
nobilitato lavagna (opz.9620) schiena e ripiano lavagna (opz.9620)

ANTE: blu cobalto, grigio minerale, polvere
nobilitato argilla (opz.9690) schiena e ripiano argilla (opz.9690)

a richiesta: nobilitato fango (opz.8860) schiena e ripiano fango (opz.8860)



MENSOLE

vedi pag.36

ZOCCOLI

vedi pag.37



tablet lacquered

Neck cod. **KT6**
Bridge cod. **KT2**
Head cod. **KT9**

TH. 18 MM

Note: the prices are expressed in units of euro (vat excluded)

TECHNICAL SPECIFICATIONS

DOORS AND DRAWER FRONT PANELS

door 18 mm thick with MDF panel (conforming to **US EPA TSCA Title VI**) external front lacquered super matt (2 gloss)
UV ray varnishing cycle, melamine back combined with the front part edged in 4 polypropylene* sides in matt colors:
white (opt.7405), anthracite (opt.9558), desert (opt.8941), black (opt.7895), cobalt blue (opt.8383), snow white (opt.7407),
alpine green (opt.8477), dust (opt.9529), velvet red (opt.8168), mineral gray (opt.9523), colorado beige (opt.7777),
cammeo red (opt.8160), cadmio yellow (opt.8255), nilo green (opt.8475)

door 18 mm thick with MDF panel (conforming to **US EPA TSCA Title VI**) external front in high-gloss lacquered (92 gloss)
UV ray varnishing cycle, melamine back combined with the front part edged in 4 polypropylene* sides in glossy colors:
white (opt.7406), anthracite (opt.9559), dust (opt.9530), black (opt.7896), desert (opt.8942),
colorado beige (opt.7778), cammeo red (opt.8164), mineral gray (opt.9523)



* High quality manufacturing technology, gives the edging a high level of resistance to acids, solvents and UV rays.
It is also an ecological product.

MAINTENANCE AND CLEANING

We recommend using a microfiber cloth dampened with water and neutral soap.
It is forbidden the use of products containing: ammonia, alcohol, bleach or abrasives.
Aggressive detergents such as degreasers or similar must also be avoided, as they can damage the painted surface.

GLASS DOORS

standard: 18 mm thick aluminium frame with brill finish, 4 mm thick frosted glass, without handle
18 mm thick aluminium frame with titanium finish, 4 mm thick bronze glass, without handle

on request: 18 mm thick aluminium frame with flint grey finish, 4 mm thick frosted glass, without handle
18 mm thick aluminium frame with dark silver finish, 4 mm thick bronze glass, without handle

PROFILE AND FINGER RAIL **NECK** VERSION

square door with "L" shaped finger rail

NOTE: for finger rail finishes see price list at page 27



HANDLES

see page 32-33-34

STRUCTURES

DOORS: white, nilo green
melamine-coated white (opt.001), white back panel and shelf (opt.001)

DOORS: alpine green, desert, cadmio yellow, cammeo red
melamine-coated shell (opt.8910), shell back panel and shelf (opt.8910)

DOORS: snow white, colorado beige, velvet red
melamine-coated mink (opt.948M), mink back panel and shelf (opt.948M)

DOORS: anthracite, black
melamine-coated slate grey (opt.9620), slate grey back panel and shelf (opt.9620)

DOORS: cobalt blue, mineral gray, dust
melamine-coated clay (opt.9690), clay back panel and shelf (opt.9690)

on request: melamine-coated mud (opt.8860), mud back panel and shelf (opt.8860)

SHELVES

see page 36

PLINTHS

see page 37



tablet laccato lacquered

Neck cod. **KT6**
Bridge cod. **KT2**
Head cod. **KT9**

ante finitura opaca
doors with matt finish

 *colori in pronta consegna*
available colours



bianco (opz.7405)
white (opt.7405)

bianco neve (opz.7407)
snow white (opt.7407)

antracite (opz.9558)
anthracite (opt.9558)

desert (opz.8941)
desert (opt.8941)

polvere (opz.9529)
dust (opt.9529)

nero (opz.7895)
black (opt.7895)

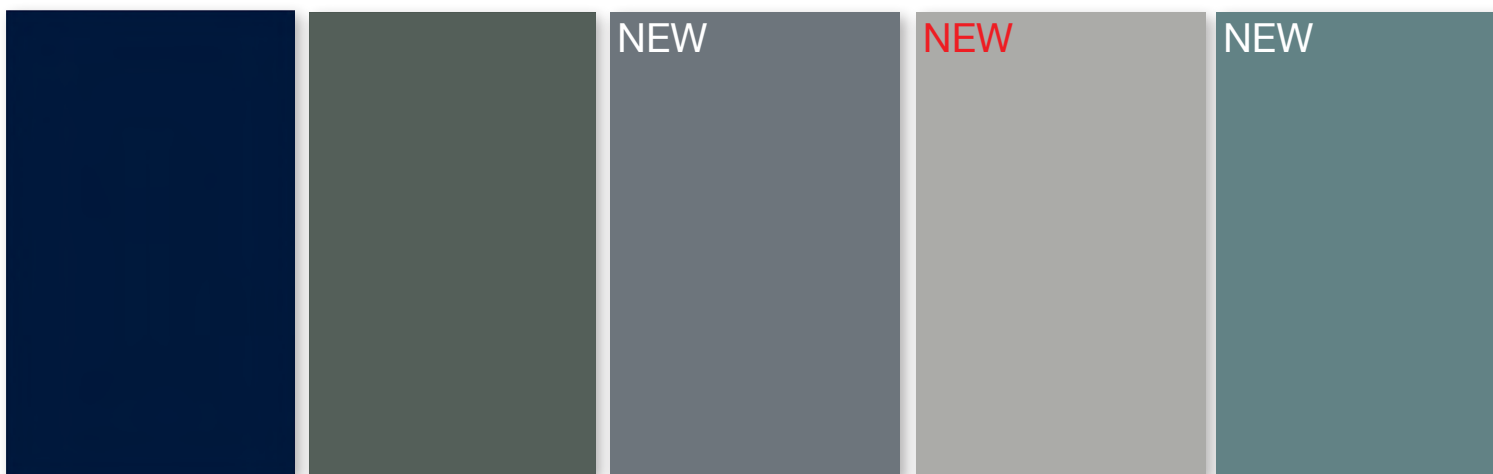

blu cobalto (opz.8383)
cobalt blue (opt.8383)

verde malga (opz.8477)
alpine green (opt.8477)

grigio minerale (opz.9523)
mineral gray (opt.9523)

beige colorado (opz.7777)
colorado beige (opt.7777)

verde nilo (opz.8475)
nilo green (opt.8475)

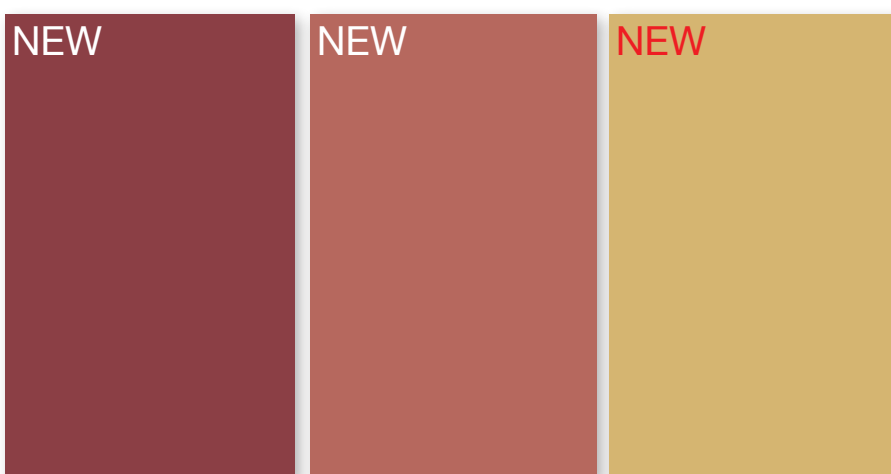

rosso velvet (opz.8168)
velvet red (opt.8168)

rosso cammeo (opz.8160)
cameo red (opt.8160)

giallo cadmio (opz.8255)
cadmio yellow (opt.8255)

tablet laccato lacquered

Neck cod. **KT6**
Bridge cod. **KT2**
Head cod. **KT9**

ante laccate lucide
gloss lacquered doors

 *colori in pronta consegna*
available colours

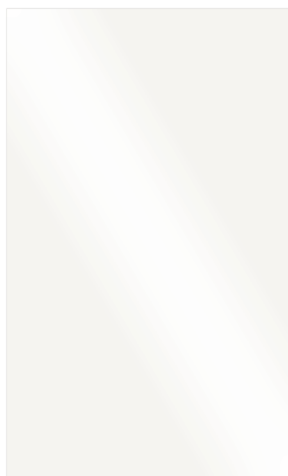

bianco (opz.7406)
white (opt.7406)



desert (opz.8942)
desert (opt.8942)



nero (opz.7896)
black (opt.7896)



antracite (opz.9559)
anthracite (opt.9559)



polvere (opz.9530)
dust (opt.9530)



grigio minerale (opz.9524)
mineral gray (opt.9524)



beige colorado (opz.7778)
colorado beige (opt.7778)



rosso cammeo (opz.8164)
cammeo red (opt.8164)

SP. 18 MM TH. 18 MM

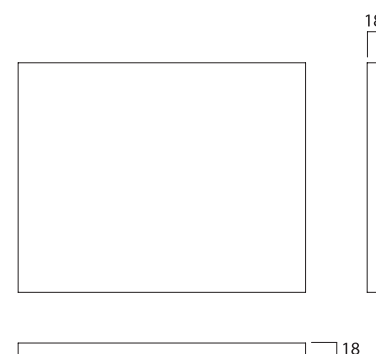

tablet vetro - glass

Telaio alluminio

Aluminium frame

telaio alluminio finitura brill sp.18 mm con vetro satinato, senza maniglia

18 mm thick aluminium frame with brill finish and frosted glass, without handle



telaio brill con vetro satinato
(opt.BTSA)
brill frame with satin glass
(opt.BTSA)



pensile con telaio brill e vetro satinato
(opt.BTSA)
wall unit with brill frame and satin glass
(opt.BTSA)

telaio alluminio finitura titanio sp.18 mm con vetro bronzo, senza maniglia

18 mm thick aluminium frame with titanium finish and bronze glass, without handle



telaio titanio con vetro bronzo
(opt.TTBR)
titanium frame with bronze glass
(opt.TTBR)



pensile con telaio titanio e vetro bronzo
(opt.TTBR)
wall unit with titanium frame and bronze glass
(opt.TTBR)

SP. 18 MM TH. 18 MM

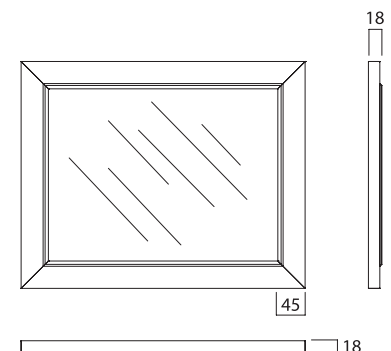

tablet vetro - glass

Telaio alluminio **NEW**

Aluminium frame

telaio alluminio finitura grigio selce sp.18 mm con vetro bronzo, senza maniglia

18 mm thick aluminium frame with flint grey finish and bronze glass, without handle



telaio grigio selce con vetro bronzo
(opz.STBR)
flint grey frame with bronze glass
(opt.STBR)



pendente con telaio grigio selce e vetro bronzo
(opz.STBR)
wall unit with flint grey frame and bronze glass
(opt.STBR)

telaio alluminio finitura silver dark sp.18 mm con vetro fumè, senza maniglia

18 mm thick aluminium frame with dark silver finish and smoked glass, without handle



telaio silver dark con vetro fumè
(opz.DTFT)
dark silver frame with smoked glass
(opt.DTFT)



pendente con telaio silver dark e vetro fumè
(opz.DTFT)
wall unit with dark silver frame and smoked glass
(opt.DTFT)

SP. 18 MM TH. 18 MM

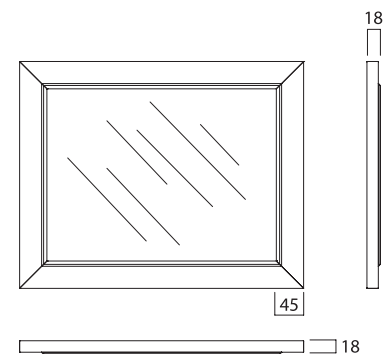

tablet vetro - glass

Telaio legno

Wood frame

N.B.: le combinazioni colori dei montanti con i traversi sono fisse, non modificabili

Note: the colours combinations of uprights with crossbars are fixed, they cannot be modified

ante vetro con montanti in melaminico effetto legno e traversi in alluminio verniciati in tinta unita, vetro flutes, senza maniglia

glass doors with wood-effect melamine uprights and crossbars in aluminium painted in solid colour, fluted glass, without handle



rovere luna con traversa desert (opz.5316)
moon oak with desert crossbar (opt.5316)



rovere venere con traversa molara (opz.5315)
venus oak with molar crossbar (opt.5315)



rovere arizona con traversa arena (opz.5317)
arizona oak with arena crossbar (opt.5317)



rovere dark con traversa porcellana (opz.5318)
dark oak with porcelain crossbar (opt.5318)



frassino lava con traversa arena (opz.2408)
lava ash with arena crossbar (opt.2408)



frassino sabbia con traversa porcellana (opz.2406)
sand ash with porcelain crossbar (opt.2406)



frassino pietra con traversa desert (opz.2407)
stone ash with desert crossbar (opt.2407)

SP. 18 MM TH. 18 MM

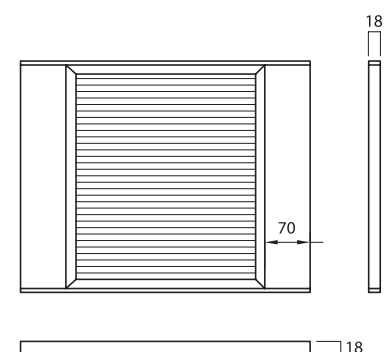

Neck

FINITURE GOLE

FINITURE GOLE SPAZZOLATE
FINGER RAILS BRUSHED FINISHES

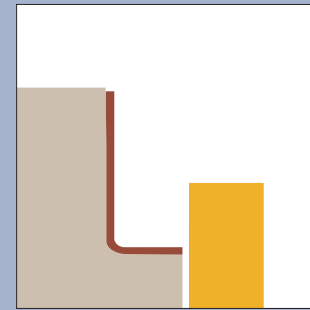
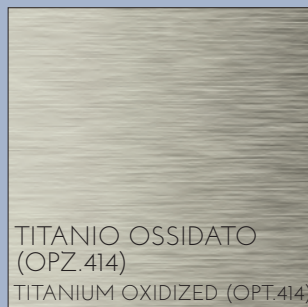
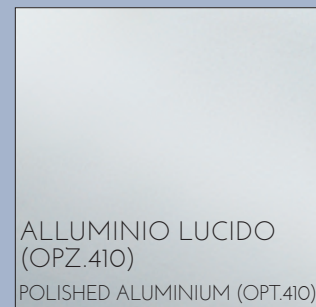

GOLA TIPO "ELLE"





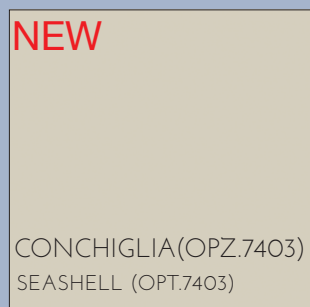
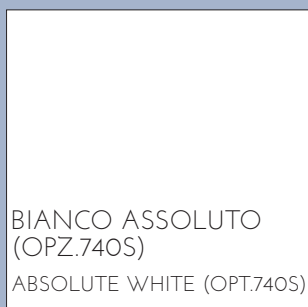
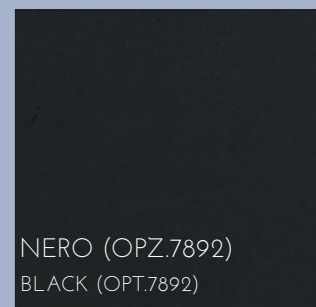

"ELLE" TYPE FINGER RAIL

FINITURE GOLE VERNICIATE A POLVERE OPACHE
MATT FINGER RAILS POWDER COATED FINISHES



GOLA "ELLE" ORIZZONTALE SOTTOTOP

UNDERMOUNT HORIZONTAL "ELLE" FINGER RAIL







	COD.	€		COD.	€
<p>Gola sottotop tipo "A" N.B.: costo gola già compreso nel prezzo delle basi Type "A" undermount finger rail Note: finger rail cost already included in base unit price</p> 					
al ml per lm	G950010	23			
			Angolo interno a 90° per gola tipo "A" N.B.: costo angolare già compreso nel prezzo delle basi angolo 90° interior corner for "A" type finger rail Note: corner piece cost already included in corner unit price		
			cadauno each	G950050	48
<p>Terminale aperto dx o sx per gola tipo "A" da utilizzare a fine composizione RH or LH open end for type "A" finger rail to be placed at the end of the composition</p> 					
in alluminio aluminium					
terminale DX RH end	G950021	23			
terminale SX LH end	G950022	23			
in plastica (solo finitura opz.410) plastic (only finish opt.410)					
terminale DX RH end	G950041	8			
terminale SX LH end	G950042	8			
<p>Angolare con snodo per unione fuori squadra per gola tipo "A" Corner piece with joint for out-of-plumb joining for type "A" finger rail</p> 					
<p>Terminale chiuso dx o sx per gola tipo "A" da utilizzare solo tra basi e colonne RH or LH closure for type "A" finger rail to be placed only between base units and column</p> 					
in alluminio aluminium					
terminale DX RH end	G950031	23			
terminale SX LH end	G950032	23			
in plastica (solo finitura opz.410) plastic (only finish opt.410)					
terminale DX RH end	G950045	8			
terminale SX LH end	G950046	8			
				G950060	57
<p>Coppia angolari per kit raccordo base angolo 110x110 Couple corner piece for fitting kit corner base unit 110x110</p> 					
in alluminio aluminium					
angolare DX RH corner piece	G950058	102			
angolare SX LH corner piece	G950059	102			
					

GOLA "ELLE" ORIZZONTALE INTERMEDIA

INTERMEDIATE HORIZONTAL "ELLE" FINGER RAIL

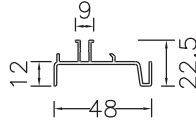
GOLE "ELLE" VERTICALI PER COLONNE

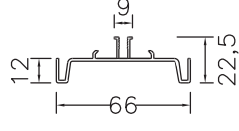
VERTICAL "ELLE" FINGER RAILS FOR COLUMNS

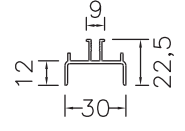
	COD.	€		COD.	€	
<p>Gola intermedia tipo "B" N.B.: costo gola già compreso nel prezzo delle basi con cassetti o cestoni Type "B" intermediate finger rail Note: finger rail cost already included in price base unit with drawers or deep drawers</p> 			<p>Mezza gola verticale tipo "C" (completa di distanziale) Type "C" half vertical finger rail (complete with spacer)</p>   <p>sezione mezza gola tipo "C" cross section of type "C" finger rail</p>			
	al ml per lm	G950110		33	<p>pedi H 13 H 96 G950310 63 H 132 G950330 83 H 204 G950350 123 H 228 G950370 136</p> <p>pedi H 6 H 108 G950320 72 H 144 G950340 95 H 216 G950360 130</p>	
<p>Terminale aperto dx o sx per gola tipo "B" da utilizzare a fine composizione RH or LH open end for type "B" finger rail to be placed at the end of the composition</p> 			<p>Gola verticale intermedia tipo "D" (completa di distanziale) Type "D" intermediate vertical finger rail (complete with spacer)</p>   <p>sezione gola tipo "D" cross section of type "D" finger rail</p>			
	in alluminio aluminium					
	terminale DX RH end	G950121		28	<p>pedi H 13 H 96 G950410 63 H 132 G950430 83 H 204 G950450 123 H 228 G950470 136</p>	
	terminale SX LH end	G950122		28		
	in plastica (solo finitura opz.410) plastic (only finish opt.410)				<p>pedi H 6 H 108 G950420 72 H 144 G950440 95 H 216 G950460 130</p>	
	terminale DX RH end	G950141		8		
terminale SX LH end	G950142	8				
<p>Terminale chiuso dx o sx per gola tipo "B" da utilizzare solo tra cassettiere e lavastoviglie/colonne RH or LH closure for type "B" finger rail to be placed only between drawer units and dishwasher/columns</p> 			<p>Gola verticale laterale tipo "E" (completa di distanziale) Type "E" lateral vertical finger rail (complete with spacer)</p>   <p>sezione gola tipo "E" cross section of type "E" finger rail</p>			
	in alluminio aluminium					
	terminale DX RH end	G950131		28	<p>pedi H 13 H 96 G950510 63 H 132 G950530 83 H 204 G950550 123 H 228 G950570 136</p>	
	terminale SX LH end	G950132		28		
	in plastica (solo finitura opz.410) plastic (only finish opt.410)				<p>pedi H 6 H 108 G950520 72 H 144 G950540 95 H 216 G950560 130</p>	
	terminale DX RH end	G950145		8		
terminale SX LH end	G950146	8				

NOZIONI UTILI - gole "elle" orizzontali per basi

USEFUL INFORMATION - HORIZONTAL "ELLE" FINGER RAILS FOR BASE UNITS

VISTA FRONTALE ZOCCOLO H 13 PER BASI H 88

FRONT VIEW PLINTH H 13 FOR BASE UNITS H 88

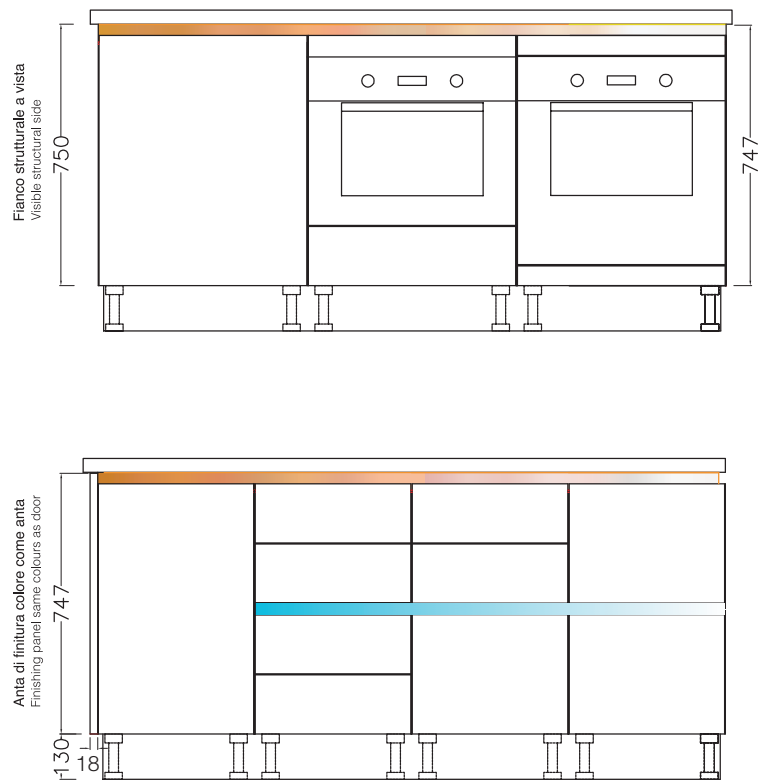

VISTA FRONTALE ZOCCOLO H 6 PER BASI H 90

FRONT VIEW PLINTH H 6 FOR BASE UNITS H 90

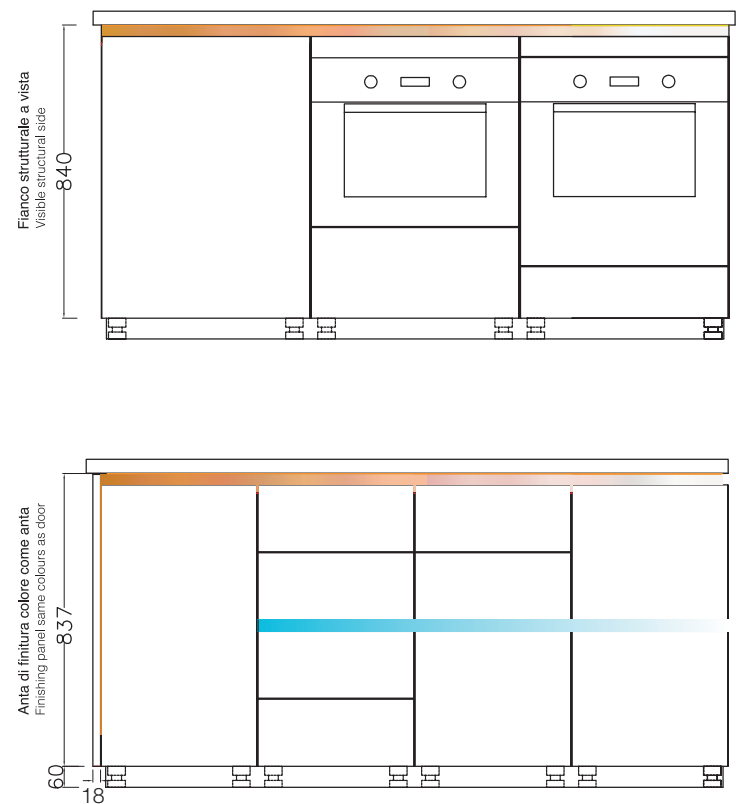

VISTA LATERALE (sezione) ZOCCOLO H 13 PER BASI H 88

SIDE VIEW (CROSS SECTION) PLINTH H 13 FOR BASE UNITS H 88

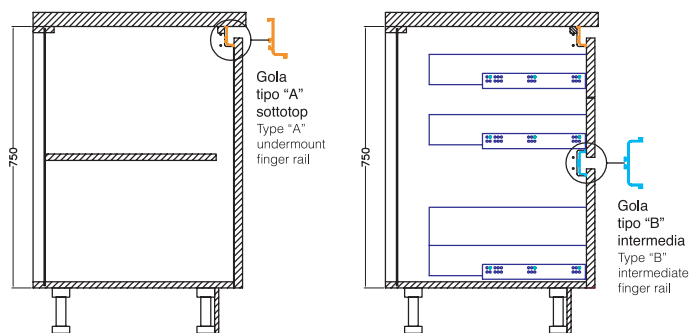

VISTA LATERALE (sezione) ZOCCOLO H 6 PER BASI H 90

SIDE VIEW (CROSS SECTION) PLINTH H 6 FOR BASE UNITS H 90

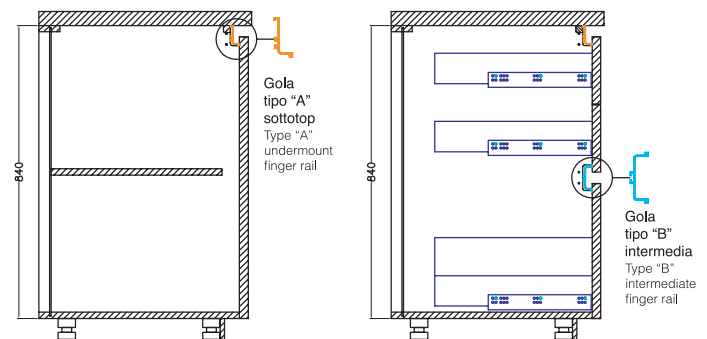

VISTA DALL'ALTO

TOP VIEW



Composizione con ante di finitura laterali: alla dimensione finale della cucina, sommare sempre lo spessore delle ante di finitura (ogni anta 18 mm)

Composition with side finishing panels: to the final size of the kitchen, always add the thickness of the finishing panels (each panel 18 mm)

NOZIONI UTILI - gole "elle" verticali per colonne

USEFUL INFORMATION - VERTICAL "ELLE" FINGER RAILS FOR COLUMNS

VISTA FRONTALE ZOCCOLO H 13

FRONT VIEW PLINTH H 13

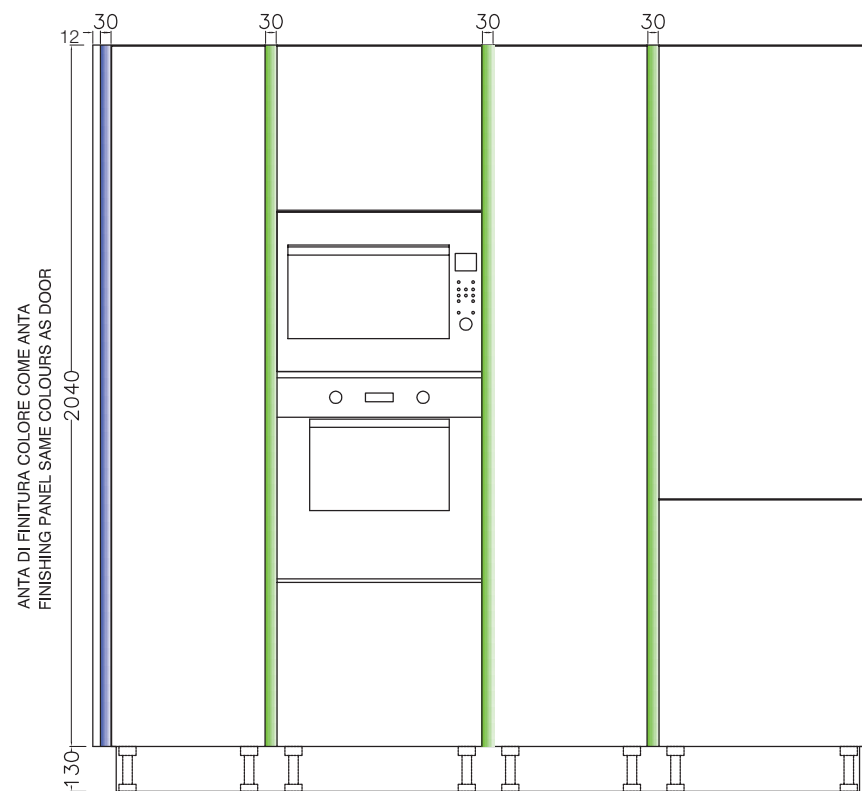

VISTA FRONTALE ZOCCOLO H 6

FRONT VIEW PLINTH H 6

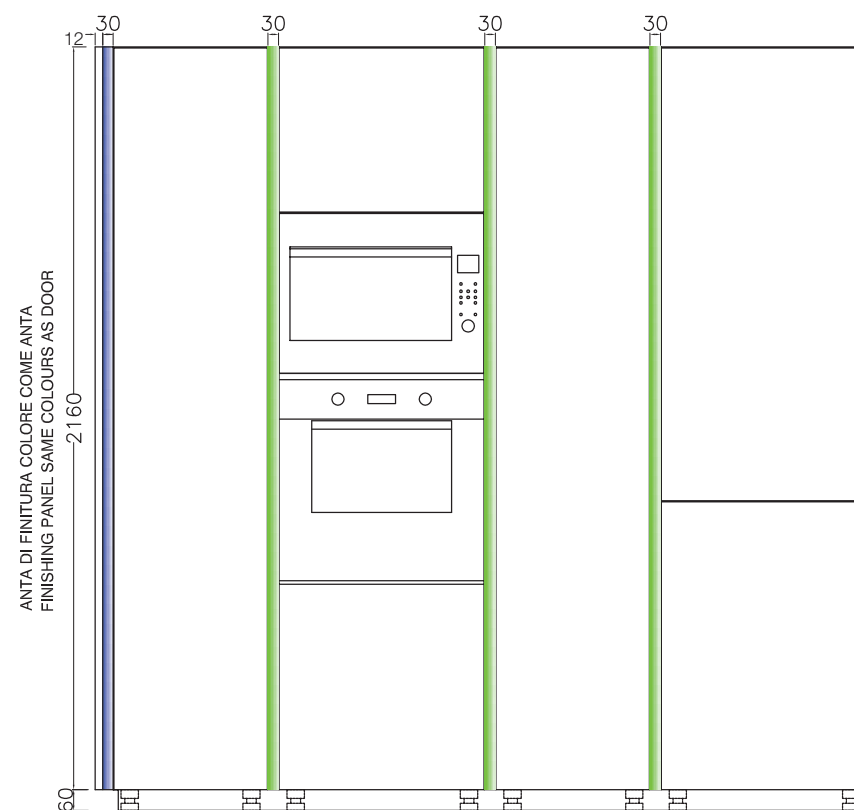

VISTA DALL'ALTO

TOP VIEW

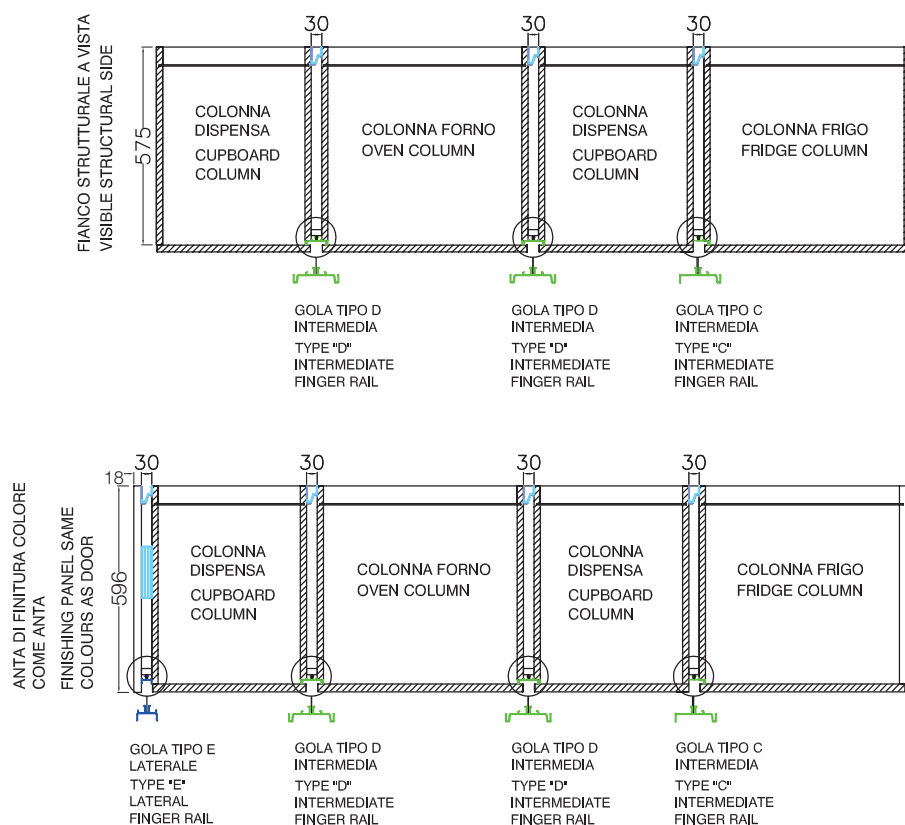

Composizione fianco strutturale
a vista come anta:
alla dimensione finale della cucina,
sommare sempre lo spessore dei
distanziali tra le colonne
(ogni distanziale 3 cm)

Composition with visible side panel to match door:
to the final size of the kitchen, always add the thickness
of the spacers between the two columns (each spacer 3 cm)

Composizione con ante di finitura
laterali, alla dimensione finale della
cucina, sommare sempre lo spessore
dei distanziali tra le colonne
(ogni distanziale 3 cm) e lo spessore
delle ante di finitura (ogni anta 1,2 cm)

Composition with side finishing panels to the final size of the
kitchen, always add the thickness of the spacer between the
two columns (each spacer 3 cm) and the thickness of the
finishing panels (each panel 12 mm)

tablet

Bridge

MANIGLIE HANDLES

DI SERIE STANDARD



Maniglia F547 finitura nichel satinato
anta L 15 → passo 64 mm
anta da L 30 a L 90 → passo 160 mm

Handle F547 with satin nickel finish
door W 15 → centre-to-centre distance 64 mm
door from W 30 to W 90 → centre-to-centre distance 160 mm

A RICHIESTA ON REQUEST



Maniglia K50 finitura cromo
anta da L 30 a L 45 → passo 160 mm
anta da L 60 a L 90 → passo 320 mm

Handle K50 chrome finish
door from W 30 to W 45 → centre-to-centre distance 160 mm
door from W 60 to W 90 → centre-to-centre distance 320 mm



Pomo 244P finitura cromo
solo per anta L 15 in abbinamento
alla maniglia K50

Knob 244P chrome finish
only for door W 15 in combination
to the handle K50



Maniglia K56 finitura satinato opaco
anta L 15 → passo 64 mm
anta da L 30 a L 60 → passo 160 mm
anta da L 75 a L 90 → passo 320 mm
(MAGGIORAZIONE 7 € CAD.)

Handle K56 matt satin finish
door W 15 → centre-to-centre distance 64 mm
door from W 30 to W 60 → centre-to-centre distance 160 mm
door from W 75 to W 90 → centre-to-centre distance 320 mm
(surcharge 7 € each)



Maniglia K57 finitura verniciato brunito
anta L 15 → passo 64 mm
anta da L 30 a L 60 → passo 160 mm
anta da L 75 a L 90 → passo 320 mm

Handle K57 with burnished painted finish
door W 15 → centre-to-centre distance 64 mm
door from W 30 to W 60 → centre-to-centre distance 160 mm
door from W 75 to W 90 → centre-to-centre distance 320 mm



Maniglia K58 finitura nero opaco
anta L 15 → passo 64 mm
anta da L 30 a L 60 → passo 160 mm
anta da L 75 a L 90 → passo 320 mm

Handle K58 matt black finish
door W 15 → centre-to-centre distance 64 mm
door from W 30 to W 60 → centre-to-centre distance 160 mm
door from W 75 to W 90 → centre-to-centre distance 320 mm



Particolare maniglia in multistrato
Detail ply handle

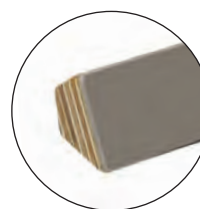

Maniglia in multistrato marino e finitura frontale in laminato nei colori:
bianco (opz.T7447P), porcellana (opz.T7703P), desert (opz.T8914P),
molara (opz.T9636P), arena (opz.T9637P)
anta L 15 → passo 64 mm
anta da L 30 a L 60 → passo 160 mm
anta L 90 → passo 320 mm
(MAGGIORAZIONE 20 € CAD.)

Handle in marine ply and front panel in laminate in the following colours:
white (opt.T7447P), porcelain (opt.T7703P), desert (opt.T8914P),
molara (opt.T9636P), arena (opt.T9637P)
door W 15 → centre-to-centre distance 64 mm
door from W 30 to W 60 → centre-to-centre distance 160 mm
door W 90 → centre-to-centre distance 320 mm
(surcharge 20 € each)



bianco
(opz.T7447P)
white

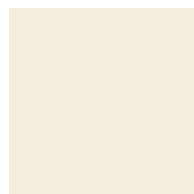

porcellana
(opz.T7703P)
porcelain



desert
(opz.T8914P)
desert



molara
(opz.T9636P)
molara



arena
(opz.T9637P)
arena

A RICHIESTA ON REQUEST



Maniglia K92 finitura grigio selce
 anta da L 15 a L 30 → passo 64 mm
 anta da L 40 a L 65 → passo 160 mm
 anta da L 75 a L 120 → passo 320 mm

Handle K92 flint grey finish
 door from W 15 to W 30 → centre-to-centre distance 64 mm
 door from W 40 to W 65 → centre-to-centre distance 160 mm
 door from W 75 to W 120 → centre-to-centre distance 320 mm



Maniglia K93 finitura ghisa
 anta da L 15 a L 30 → passo 64 mm
 anta da L 40 a L 65 → passo 160 mm
 anta da L 75 a L 120 → passo 320 mm

Handle K93 caston iron finish
 door from W 15 to W 30 → centre-to-centre distance 64 mm
 door from W 40 to W 65 → centre-to-centre distance 160 mm
 door from W 75 to W 120 → centre-to-centre distance 320 mm



Maniglia K94 finitura silver dark
 anta da L 15 a L 30 → pomo
 anta da L 40 a L 65 → passo 160 mm
 anta da L 75 a L 120 → passo 320 mm

Handle K94 dark silver finish
 door from W 15 to W 30 → knob
 door from W 40 to W 65 → centre-to-centre distance 160 mm
 door from W 75 to W 120 → centre-to-centre distance 320 mm



Maniglia K85 finitura cromo satinato
 anta da L 15 a L 30 → passo 96 mm
 anta da L 40 a L 65 → passo 160 mm
 anta da L 75 a L 120 → passo 320 mm

Handle K85 satin chrome finish
 door from W 15 to W 30 → centre-to-centre distance 96 mm
 door from W 40 to W 65 → centre-to-centre distance 160 mm
 door from W 75 to W 120 → centre-to-centre distance 320 mm



Maniglia K87 finitura nichel lux
 anta da L 15 a L 30 → passo 96 mm
 anta da L 40 a L 65 → passo 160 mm
 anta da L 75 a L 120 → passo 320 mm

Handle K87 lux nikel finish
 door from W 15 to W 30 → centre-to-centre distance 96 mm
 door from W 40 to W 65 → centre-to-centre distance 160 mm
 door from W 75 to W 120 → centre-to-centre distance 320 mm



Maniglia K90 finitura bronzo
 anta da L 15 a L 30 → passo 64 mm
 anta da L 40 a L 120 → passo 160 mm

Handle K90 bronze finish
 door from W 15 to W 30 → centre-to-centre distance 64 mm
 door from W 40 to W 120 → centre-to-centre distance 160 mm

tablet

Head

MANIGLIE HANDLES

DI SERIE STANDARD



Maniglia 910T finitura titanio
Handle 910T titanium finish



Maniglia 910B finitura brill
Handle 910B brill finish

A RICHIESTA ON REQUEST



Maniglia 913T finitura titanio
Handle 913T titanium finish



Maniglia 913B finitura brill
Handle 913B brill finish



Maniglia 920T finitura titanio
Handle 920T titanium finish





strutture carcasses



bianco (opz.001)
schiena e ripiano bianco
(opz.001)
white (opt.001)
white back panel and shelf
(opt.001)

conchiglia (opz.8910)
schiena e ripiano conchiglia
(opz.8910)
shell (opt.8910)
shell back panel and shelf
(opt.8910)

visone (opz.948M)
schiena e ripiano visone
(opz.948M)
mink (opt.948M)
mink back panel and shelf
(opt.948M)

lavagna (opz.9620)
schiena e ripiano lavagna
(opz.9620)
slate grey (opt.9620)
slate grey back panel
and shelf (opt.9620)

fango (opz.8860)
schiena e ripiano fango
(opz.8860)
mud (opt.8860)
mud back panel and shelf
(opt.8860)

argilla (opz.9690)
schiena e ripiano argilla
(opz.9690)
clay (opt.9690)
clay back panel and shelf
(opt.9690)



Il Gruppo LUBE è stata la prima azienda in Italia ad ottenere per le strutture delle sue cucine la **Certificazione GREENGUARD Gold**, che è garanzia della **bassissima emissione di sostanze chimiche inquinanti COV.**

Gruppo Lube was the first company in Italy achieving the GREENGUARD Gold Certification for its kitchen structures, which is a guarantee of the very low VOC polluting chemicals emission.



CREO ECOLOGIC

IL GRUPPO LUBE HA SCELTO DI UTILIZZARE PER I COMPONENTI COSTITUENTI LE STRUTTURE DELLE CUCINE SOLO MATERIALE A BASSISSIMA EMISSIONE DI FORMALDEIDE: CONFORMI ALLO STANDARD FASTELLE SECONDO LA NORMA JIS, CERTIFICATO DAL MINISTERO GIAPPONESE, IL PIU' SEVERO IN MERITO ALLE NORMATIVE DI SALVAGUARDIA AMBIENTALE.

LUBE GROUP HAS CHOSEN TO EXCLUSIVELY USE MATERIALS WITH VERY LOW FORMALDEHYDE EMISSIONS FOR THE COMPONENTS MAKING UP THE KITCHEN CARCASSES; THESE ELEMENTS COMPLY WITH THE F4 STAR STANDARD ACCORDING TO JIS, CERTIFIED BY THE JAPANESE GOVERNMENT - THE MOST STRINGENT WHEN IT COMES TO ENVIRONMENTAL PROTECTION.

mensole in nobilitato P 31-61 SP.3,8 come strutture same colours as carcasses melamine coated shelves D 31-61 Th.3,8

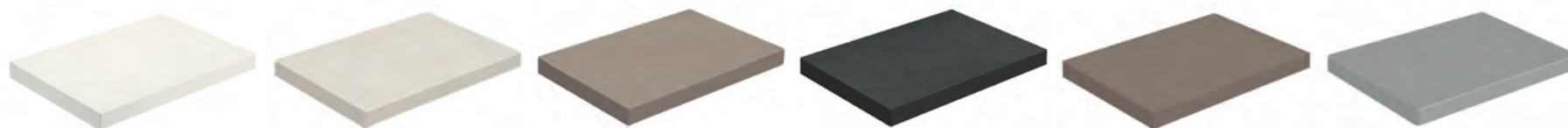

bianco (opz.001)
white (opt.001)

conchiglia (opz.8910)
shell (opt.8910)

visone (opz.948M)
mink (opt.948M)

lavagna (opz.9620)
slate grey (opt.9620)

fango (opz.8860)
mud (opt.8860)

argilla (opz.9690)
clay (opt.9690)

mensole in melaminico P 31-33,1-61 SP.3,8 melamine shelves D 31-33,1-61 Th.3,8

melaminico bordo in tinta melamine with matching edge



rovere arizona (opz.5317)
arizona oak (opt.5317)

N.B.: disponibili in tutti i colori come ante in melaminico, vedi pag.14-17

Note: available in all melamine-coated door colours, see page 14-17

melaminico tinta unita bordo multistrato solid colour melamine with ply edge



desert soft matt (opz.8914M)
soft matt desert (opt.8914M)

N.B.: disponibili in tutti i colori come ante in melaminico tinta unita bordo multistrato, vedi pag.18

Note: available in all melamine-coated door solid colours with ply edge, see page 18

mensole laccate opache e lucide P 31-33,2-61 SP.3,8 matt and glossy lacquered shelves D 31-33,2-61 Th.3,8

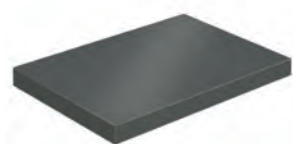

antracite (opz.9559)
anthracite (opt.9559)

N.B.: disponibili in tutti i colori come ante laccate opache e lucide vedi pag.22-23

Note: available in all matt and glossy lacquer door colours, see page 22-23

mensole impialacciate wood P 31-61 SP.3,8

wood veneered shelves D 31-61 Th.3,8

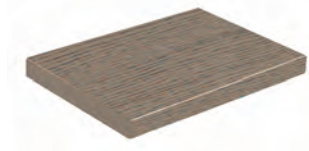

rovere grey (opz.5443)
grey oak (opt.5443)

N.B.: disponibili in tutti i colori come ante impialacciate wood, vedi pag.11

Note: available in all wood veneered door colours, see page 11

zoccoli in pvc H 13 pvc plinths H 13

di serie
standard



acciaio (opz.407)
steel (opt.407)



alluminio satinato
(opz.405)
satin aluminium
(opt.405)



bianco (opz.001)
white (opt.001)

zoccoli in alluminio H 13 aluminium plinths H 13

magg. rispetto allo zoccolo standard
surcharges compared to standard plinth



alluminio
finitura brill
(opz.412)
aluminium
brill finish (opt.412)



alluminio finitura titanio
ossidato (opz.414)
aluminium titanium
oxidized finish (opt.414)

al ml per lm cod.092125 +20 €
code

angolare cod.0923933 +2 €
angular code

zoccoli in alluminio H 13 verniciati a polvere finitura opaca aluminum plinth height H 13 powder coated matt finish

magg. rispetto allo zoccolo standard
surcharges compared to standard plinth



alluminio finitura bianco
assoluto (opz.740S)
aluminium absolute
white finish (opt.740S)



alluminio finitura
grigio selce (opz.SE)
aluminium flint grey
finish (opt.SE)



alluminio finitura
silver dark (opz.9507)
aluminium dark silver
finish (opt.9507)



alluminio finitura
ghisa (opz.9509)
aluminium cast iron
finish (opt.9509)

al ml per lm cod.092125 +35 €
code

angolare cod.0923933 +4 €
angular code

MODULARITÀ E COMPONENTIBILITÀ MODULARITY AND FITTING SOLUTIONS

BASI H 76

BASE UNITS H 76

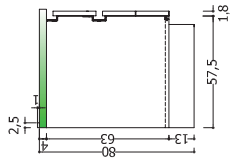

BASI LIVING CON ZOCCOLO

ROOM UNITS WITH PLINTH

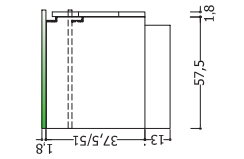

BASI LIVING CON PIEDINO CROMATO H 2

ROOM UNITS WITH FEET CHROME H 2

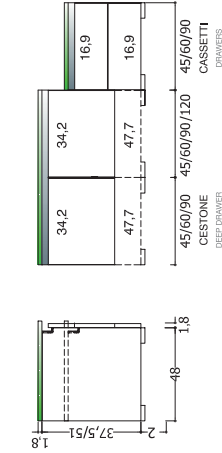

COLONNE FRIGO

FRIDGE COLUMNS

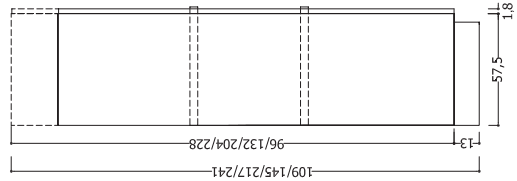

COLONNE FORNO



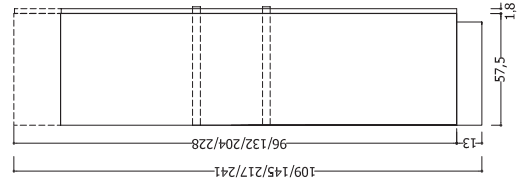



OVEN COLUMNS

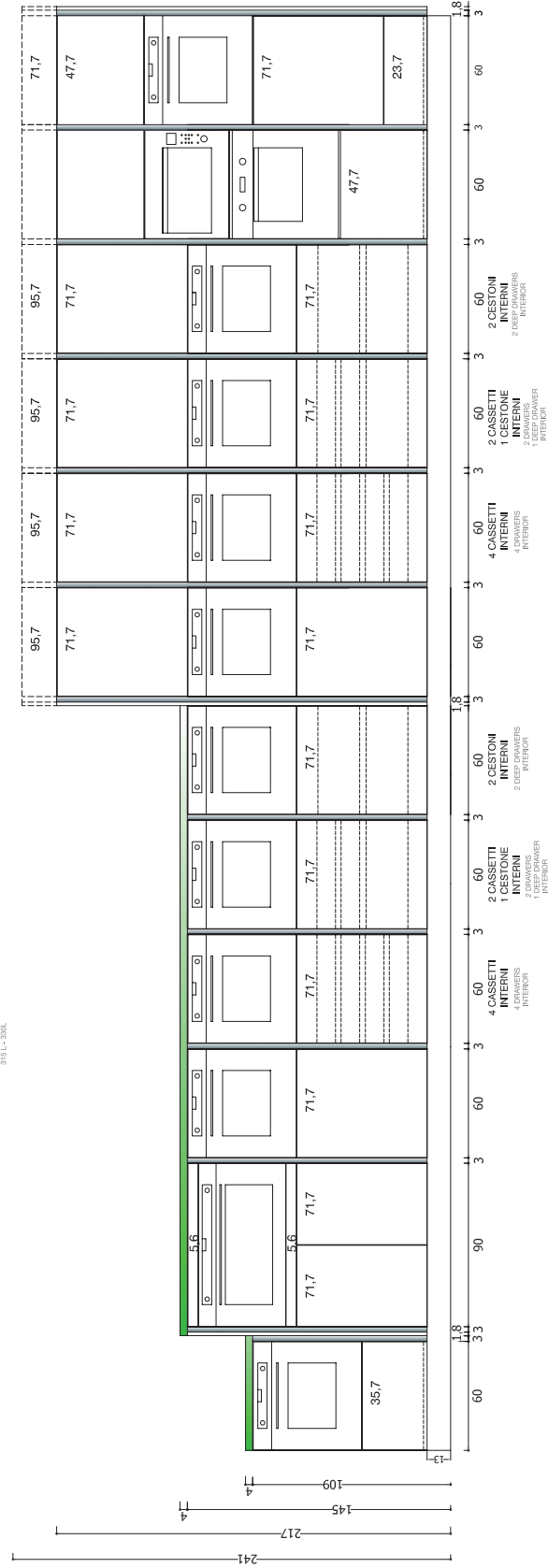
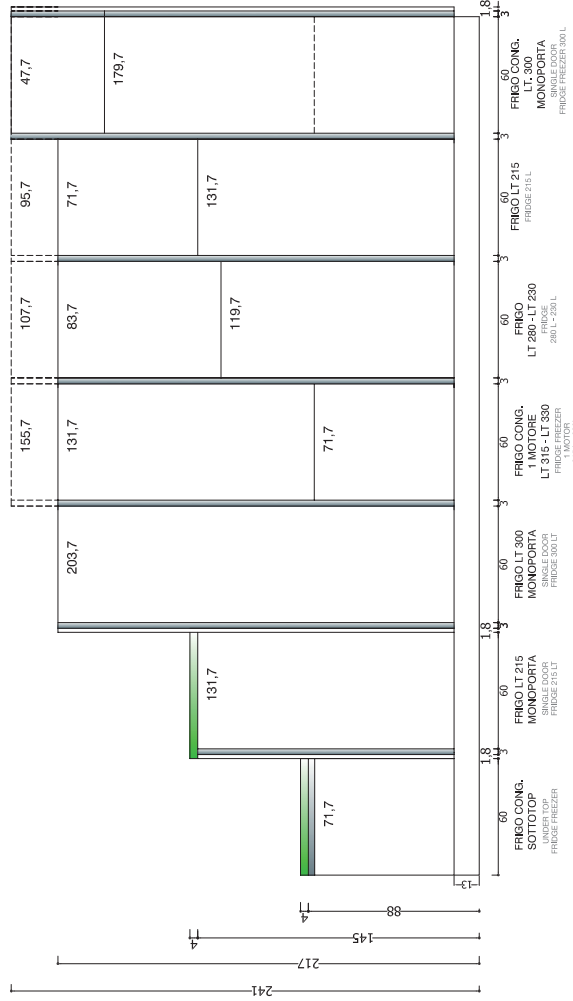
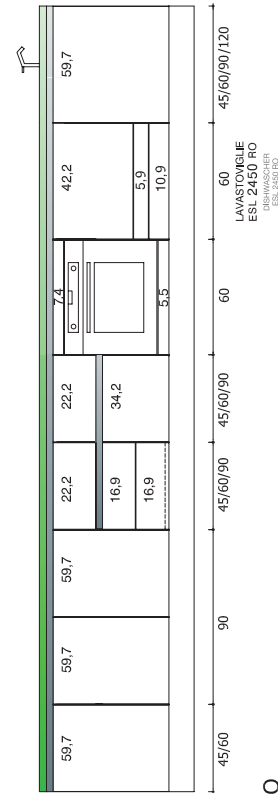
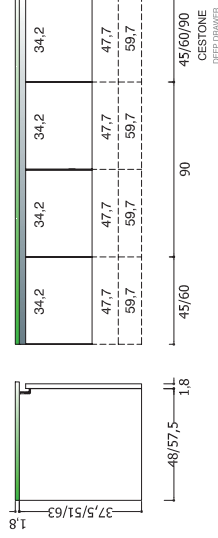

BASI SOSPESE

HANGING BASE UNITS

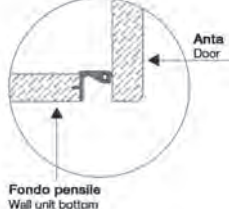

N.B.: cerniere ammortizzate di serie Note: standard blumotion hinges		COD.	NECK	NECK	NECK			
			MELAMI- NICO KT5	LACCATO KT6	WOOD KT4			
 <p>1 anta H 36 1 door H 36</p>	L 45	G2030451/2	86	92	116			
	L 60	G2030601/2	92	101	131			
	L 65	G2030651/2	103	109	138			
 <p>1 anta H 48 1 door H 48</p>	L 45	G2040451/2	100	109	138			
	L 60	G2040601/2	109	121	158			
	L 65	G2040651/2	114	128	167			
 <p>1 anta H 60 1 door H 60</p>	L 45	G2060451/2	106	118	150			
	L 60	G2060601/2	117	132	167			
 <p>1 anta H 72 1 door H 72</p>	L 15	G2010151/2	90	98	116			
	L 30	G2010301/2	98	107	136			
	L 40	G2010401/2	106	118	155			
	L 45	G2010451/2	109	123	163			
	L 60	G2010601/2	121	139	191			
	L 65	G2010651/2	126	144	200			
 <p>1 anta H 96 1 door H 96</p>	L 15	G2020151/2	103	113	134			
	L 30	G2020301/2	115	128	163			
	L 40	G2020401/2	125	141	188			
	L 45	G2020451/2	130	147	200			
	L 60	G2020601/2	149	173	240			
	L 65	G2020651/2	155	180	252			
 <p>1 anta H 108 1 door H 108</p>	L 30	G2144301/2	138	153	150			
	L 45	G2144451/2	151	174	224			
	L 60	G2144601/2	169	197	264			
	L 65	G2144651/2	174	206	278			
 <p>1 anta H 120 1 door H 120</p>	L 30	G2145301/2	178	193	228			
	L 45	G2145451/2	195	217	270			
	L 60	G2145601/2	215	244	313			
 <p>Apertura senza maniglia, presa sul fondo Grip on bottom opening, without handle</p> <p>Anta Door</p> <p>Fondo pensile Wall unit bottom</p>								







PENSILI







WALL UNITS



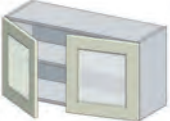

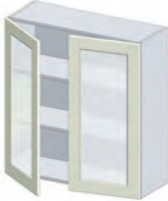

P 33

N.B.: cerniere ammortizzate di serie Note: standard blumotion hinges		COD.	NECK MELAMI- NICO KT5	NECK LACCATO KT6	NECK WOOD KT4			
 <p>2 ante H 36 2 doors H 36</p>	L 90	G2030900	132	146	188			
	 <p>2 ante H 48 2 doors H 48</p>	L 90	G2040900	154	173	226		
 <p>2 ante H 60 2 doors H 60</p>		L 90	G2060900	164	187	241		
	 <p>2 ante H 72 2 doors H 72</p>	L 60	G2010600	146	165	219		
L 80		G2010800	163	188	256			
L 90		G2010900	170	198	274			
 <p>2 ante H 96 2 doors H 96</p>	L 60	G2020600	172	197	265			
	L 80	G2020800	193	225	314			
	L 90	G2020900	202	235	337			
 <p>2 ante H 108 2 doors H 108</p>	L 90	G2144900	228	273	377			
	 <p>cestello estraibile chiusura soft pull-out basket unit soft-closing system</p>	H 72 L 15	G2010150	140	146	154		
H 96 L 15		G2020150	167	175	186			
H 108 L 15		G2144150	166	175	191			
 <p>fascia tamponamento L da 3 a 15 filler panel size from 3 to 15</p>	H 60	G2790000	59	64	79			
	H 72	G2800000	59	64	83			
	H 96	G2810000	71	81	95			
	H 108	G2810800	80	92	109			
	H 120	G2810805	88	96	115			

N.B.: cerniere ammortizzate di serie
Note: standard blumotion hinges

		COD.	NECK MELAMI- NICO KT5	NECK LACCATO KT6	NECK WOOD KT4			
 <p>1 anta vetro H 36 1 glass door H 36</p>	telaio alluminio L 45 aluminium frame	G1032451/2	161	161	161			
	L 60	G1032601/2	177	177	177			
	telaio melaminico L 45 melamine frame	G1030451/2	201	—	—			
	L 60	G1030601/2	226	—	—			
 <p>1 anta vetro H 48 1 glass door H 48</p>	telaio alluminio L 45 aluminium frame	G1042451/2	182	182	182			
	L 60	G1042601/2	202	202	202			
	telaio melaminico L 45 melamine frame	G1040451/2	225	—	—			
	L 60	G1040601/2	254	—	—			
 <p>1 anta vetro H 60 1 glass door H 60</p>	telaio alluminio L 60 aluminium frame	G1062601/2	220	220	220			
	telaio melaminico L 60 melamine frame	G1060601/2	261	—	—			
 <p>1 anta vetro H 72 1 glass door H 72</p>	telaio alluminio L 45 aluminium frame	G1012451/2	207	207	207			
	L 60	G1012601/2	231	231	231			
	telaio melaminico L 45 melamine frame	G1010451/2	255	—	—			
	L 60	G1010601/2	275	—	—			
 <p>1 anta vetro H 96 1 glass door H 96</p>	telaio alluminio L 45 aluminium frame	G1022451/2	250	250	250			
	L 60	G1022601/2	289	289	289			
	telaio melaminico L 45 melamine frame	G1020451/2	274	—	—			
	L 60	G1020601/2	329	—	—			
 <p>terminale H 72 31x31 a giorno tipo "A" open end unit H 72 31x31 type "A"</p> <p>H 72</p>	H 72							
	colore come struttura same colour as carcass	G2620310	82	82	82			
 <p>terminale H 96 31x31 a giorno tipo "A" open end unit H 96 31x31 type "A"</p> <p>H 96</p>	H 96							
	colore come struttura same colour as carcass	G2630310	99	99	99			

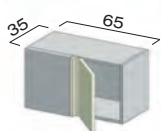
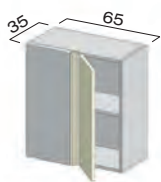
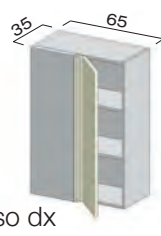





N.B.: cerniere ammortizzate di serie Note: standard blumotion hinges		COD.	NECK	NECK	NECK			
			MELAMI- NICO KT5	LACCATO KT6	WOOD KT4			
 <p>2 ante vetro H 36 2 glass doors H 36</p>	<p>telaio alluminio L 90 aluminium frame</p> <p>telaio melaminico L 90 melamine frame</p>	G1032900	285	285	285			
		G1030900	364	—	—			
 <p>2 ante vetro H 48 2 glass doors H 48</p>	<p>telaio alluminio L 90 aluminium frame</p> <p>telaio melaminico L 90 melamine frame</p>	G1042900	321	321	321			
		G1040900	403	—	—			
 <p>2 ante vetro H 72 2 glass doors H 72</p>	<p>telaio alluminio L 90 aluminium frame</p> <p>telaio melaminico L 90 melamine frame</p>	G1012900	370	370	370			
		G1010900	467	—	—			
 <p>2 ante vetro H 96 2 glass doors H 96</p>	<p>telaio alluminio L 90 aluminium frame</p> <p>telaio melaminico L 90 melamine frame</p>	G1022900	446	446	446			
		G1020900	496	—	—			
 <p>jolly pensile H 72 L da 10 a 30 jolly wall unit H 72 size from 10 to 30</p>	<p>colore come struttura same colour as carcass</p> <p>melaminico come anta melamine same as door</p> <p>impiallacciato come anta (folding) veneered same as door (folding)</p>	G2700000	115	115	115			
		G2700030	144	—	—			
		G2707220	—	—	360			
 <p>jolly pensile H 96 L da 10 a 30 jolly wall unit H 96 size from 10 to 30</p>	<p>colore come struttura same colour as carcass</p> <p>melaminico come anta melamine same as door</p> <p>impiallacciato come anta (folding) veneered same as door (folding)</p>	G2710000	140	140	140			
		G2710030	180	—	—			
		G2709620	—	—	443			
 <p>jolly pensile H 108 L da 10 a 30 jolly wall unit H 108 size from 10 to 30</p>	<p>colore come struttura same colour as carcass</p> <p>melaminico come anta melamine same as door</p> <p>impiallacciato come anta (folding) veneered same as door (folding)</p>	G2710800	150	150	150			
		G2710830	217	—	—			
		G2710820	—	—	471			

N.B.: cerniere ammortizzate di serie Note: standard blumotion hinges		COD.	NECK MELAMI- NICO KT5	NECK LACCATO KT6	NECK WOOD KT4			
 <p>angolo H 36 2 ante a libretto N.B.: fuori squadra realizzabili da 88° a 92° corner unit H 36 2 folding doors Note: out-of-plumb units available from 88° to 92°</p>	65X65	G2445651/2	217	220	237			
 <p>angolo H 72 2 ante a libretto N.B.: fuori squadra realizzabili da 88° a 92° corner unit H 72 2 folding doors Note: out-of-plumb units available from 88° to 92°</p>	65X65	G2450651/2	224	245	316			
 <p>angolo H 96 2 ante a libretto N.B.: fuori squadra realizzabili da 88° a 92° corner unit H 96 2 folding doors Note: out-of-plumb units available from 88° to 92°</p>	65X65	G2460651/2	279	306	386			
 <p>angolo H 108 2 ante a libretto N.B.: fuori squadra realizzabili da 88° a 92° corner unit H 108 2 folding doors Note: out-of-plumb units available from 88° to 92°</p>	65X65	G2463651/2	318	330	347			
 <p>angolo H 36 1 anta N.B.: fuori squadra realizzabili da 88° a 94° corner unit H 36 1 door Note: out-of-plumb units available from 88° to 94°</p>	verso dx RH version	65X35	G2490651/2	177	193	230		
 <p>angolo H 72 1 anta N.B.: fuori squadra realizzabili da 88° a 94° corner unit H 72 1 door Note: out-of-plumb units available from 88° to 94°</p>	verso dx RH version	65X35	G2491651/2	177	193	277		
 <p>angolo H 96 1 anta N.B.: fuori squadra realizzabili da 88° a 94° corner unit H 96 1 door Note: out-of-plumb units available from 88° to 94°</p>	verso dx RH version	65X35	G2495651/2	214	234	331		
 <p>angolo H 108 1 anta N.B.: fuori squadra realizzabili da 88° a 94° corner unit H 108 1 door Note: out-of-plumb units available from 88° to 94°</p>	verso dx RH version	65X35	G2497651/2	320	351	411		

PENSILI

WALL UNITS

P 33 - 47 - 59,5

N.B.: cerniere ammortizzate di serie Note: standard blumotion hinges		COD.	NECK	NECK	NECK			
			MELAMI- NICO KT5	LACCATO KT6	WOOD KT4			
 <p>angolo H 72 1 anta diagonale corner unit H 72 1 diagonal door</p>	65X65	G2400651/2	180	194	237			
		 <p>angolo H 96 1 anta diagonale corner unit H 96 1 diagonal door</p>	65X65	G2410651/2	212	229	285	
 <p>angolo H 108 1 anta diagonale corner unit H 108 1 diagonal door</p>	65X65			G2420651/2	251	285	327	
		 <p>copriboiler H 72 1 anta boiler housing H 72 1 door</p>	P 33 L 60	G2150601/2	109	128	187	
P 47 L 60	G2160601/2		155	186	220			
P 59,5 L 60	G2170601/2		155	186	220			
 <p>copriboiler H 96 1 anta boiler housing H 96 1 door</p>	P 33 L 60	G2210601/2	124	149	226			
	P 47 L 60	G2220601/2	181	218	290			
	P 59,5 L 60	G2230601/2	181	218	290			
 <p>copriboiler H 108 1 anta boiler housing H 108 1 door</p>	P 33 L 60	G2250601/2	157	186	258			
	P 47 L 60	G2260601/2	208	239	318			
	P 59,5 L 60	G2270601/2	208	239	318			

PENSILE CON APERTURA A RIBALTA

Le ante aprendosi verso l'alto consentono di avere un' ampia visione d'insieme all'interno del mobile. In questo modo è possibile un comodo accesso agli oggetti contenuti al suo interno e, dal punto di vista ergonomico, molto vantaggioso. La regolazione della forza di apertura può essere impostata in modo esatto in base al peso del frontale. Grazie all'arresto progressivo le ante si fermano in qualsiasi posizione; in questo modo la maniglia è sempre facilmente raggiungibile. La chiusura è ammortizzata di serie.

WALL UNIT WITH FLAP DOOR

The doors that open upwards guarantee ample overall visibility inside the cabinet. In this way, all objects housed inside the cabinet can be comfortably accessed, making the system highly advantageous from an ergonomic perspective. The opening force can be adjusted precisely according to the weight of the front. The doors stop in any position thanks to the gradual stopping movement; in this way, the handle is always easily accessible. The closing movement is cushioned standard

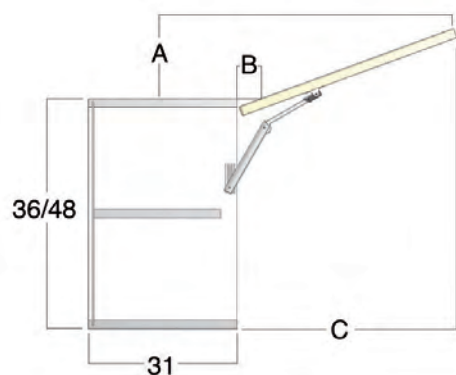



	A	B	C
H 36	7	4	37
H 48	11	4	49

PENSILI RIBALTA CHIUSURA AMMORTIZZATA

FLAP DOOR WALL UNITS BLUMOTION CLOSING SYSTEM

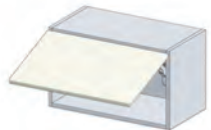

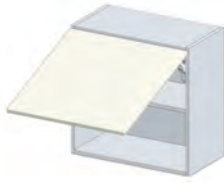
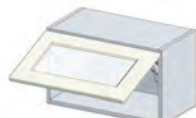
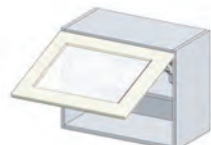
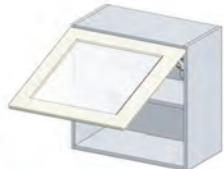
N.B.: sovrapponibili solo con le ribalte tip-on
 Note: overlapping only with tip-on flap doors

		COD.	NECK MELAMI- NICO KT5	NECK LACCATO KT6	NECK WOOD KT4			
 <p>anta ribalta H 36 flap door H 36</p>	L 45	G2100450	112	119	152			
	L 60	G2100600	115	126	162			
	L 65	G2100650	127	136	168			
	L 90	G2100900	146	160	210			
	L 120	G2101200	190	208				
 <p>anta ribalta H 48 flap door H 48</p>	L 45	G2120450	149	161	173			
	L 60	G2120600	148	160	206			
	L 65	G2120650	159	171	215			
	L 90	G2120900	168	186	237			
	L 120	G212120C	248	275				
 <p>anta ribalta H 60 flap door H 60</p>	L 60	G212560C	201	217	273			
	L 90	G212590C	248	271	346			
 <p>anta vetro ribalta H 36 glass flap door H 36</p>	telaio alluminio L 45 aluminium frame	G1102450	186	186	186			
	L 60	G1102600	202	202	202			
	L 90	G1102900	255	255	255			
 <p>anta vetro ribalta H 48 glass flap door H 48</p>	telaio alluminio L 45 aluminium frame	G1122450	229	229	229			
	L 60	G1122600	283	283	283			
	L 90	G1122900	323	323	323			
 <p>anta vetro ribalta H 60 glass flap door H 60</p>	telaio alluminio L 60 aluminium frame	G1132600	299	299	299			
	L 90	G1132900	368	368	368			

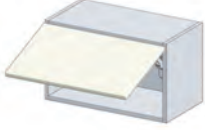
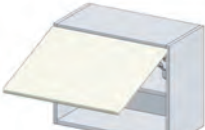

Grazie al meccanismo TIP-ON, le ante a ribalta senza maniglia possono essere aperte semplicemente con un leggero tocco. Per chiudere l'anta a ribalta, è sufficiente esercitare una leggera pressione, che grazie ad una piastrina di bloccaggio, applicata sul lato interno del frontale, ne assicura la perfetta chiusura.

Thanks to TIP-ON mechanism, the flap doors without handles can be opened with a simple touch. To close the flap door, just exercise light pressure, thanks to the locking plate, applied on the inner side of the front panel ensures a perfect closure.

	COD.	NECK MELAMI- NICO KT5	NECK LACCATO KT6	NECK WOOD KT4				
 <p>anta ribalta TIP-ON H 36 flap door TIP-ON H 36</p>	L 45	G210046T	111	119	154			
	L 60	G210061T	114	124	165			
	L 65	G210066T	120	128	170			
	L 90	G210091T	153	167	223			
	L 120	G210121T	213	231	—			
	 <p>anta ribalta TIP-ON H 48 flap door TIP-ON H 48</p>	L 45	G212046T	148	160	176		
L 60		G212061T	154	167	219			
L 65		G212066T	159	172	238			
L 90		G212091T	174	193	260			
L 120		G212121T	273	299	—			
 <p>anta ribalta TIP-ON H 60 flap door TIP-ON H 60</p>		L 60	G212561T	196	212	280		
	L 90	G212591T	243	266	346			

APERTURA VERTICALE OBLIQUA

I pensili con questo tipo di meccanismo necessitano per l'apertura di poco spazio libero sopra il mobile grazie al movimento basculante dell'anta che si apre senza difficoltà applicando poca forza anche in presenza di frontali pesanti. Con l'arresto progressivo le ante si fermano in qualsiasi posizione; in questo modo la maniglia è sempre facilmente raggiungibile. La chiusura è ammortizzata ed è possibile regolare la forza di tenuta in base al peso del frontale.

VERTICAL OPENING OBLIQUE

Wall units that mount this type of mechanism require little clearance above the cabinet thanks to the swivelling movement of the door that can be easily opened by applying slight pressure, even with heavy fronts. The doors stop in any position thanks to the gradual stopping movement; in this way, the handle is always easily accessible. The closing movement is cushioned and the closing force can be adjusted according to the weight of the front door.

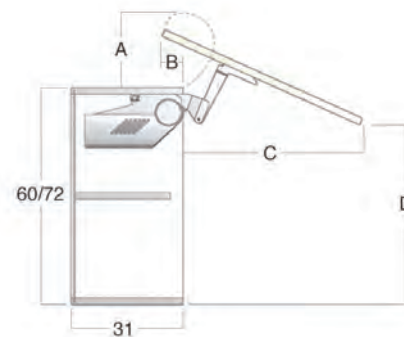

	A	B	C	D
H 60	18	9,6	46,5	53,5
H 72	18	9,6	57	61

PENSILE CON APERTURA ANTE A PACCHETTO

Il meccanismo d'apertura ante a pacchetto è idoneo sia sul pensile H 72 che H 96; la regolazione della forza di apertura può essere impostata in modo esatto in base ai pesi dei frontali, la chiusura è ammortizzata e la cerniera centrale clip si contraddistingue per l'innovativa tecnologia che garantisce la sicurezza per le dita.

WALL UNIT WITH LIFT-UP FOLDING DOORS

The lift-up folding door opening mechanism is suitable for wall units with H 72 or H 96; the opening force can be adjusted precisely according to the weight of the fronts, while the closing movement is cushioned and the central clip-on hinge features innovative technology for safeguarding the fingers.

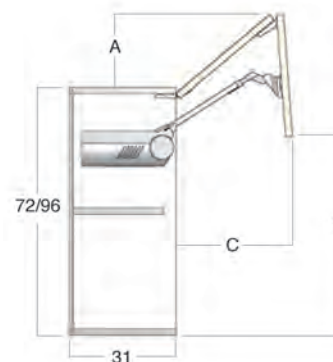

	A	B	C
H 72	16,5	54	41
H 96	20	69	53

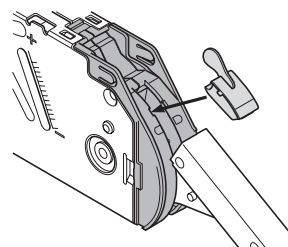
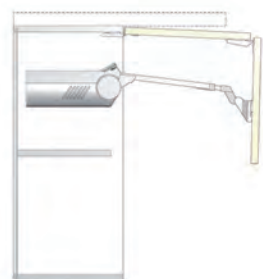

SCHEMA MONTAGGIO LIMITATORE
LIMITER INSTALLATION
DIAGRAM

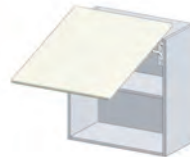
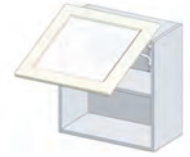
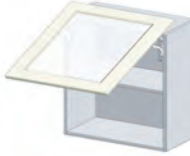

Per evitare l'interferenza dell'anta in fase di apertura con cornici o mensole, si può richiedere il limitatore dell'angolo di apertura cod. 5620005 € 10

In order to avoid that the door interferes with cornices or shelves during the opening movement, it is possible to request an opening angle limiter: code 5620005 € 10

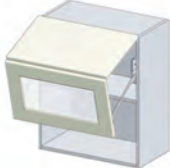
	COD.	NECK MELAMI- NICO KT5	NECK LACCATO KT6	NECK WOOD KT4			
<p>anta apertura verticale obliqua H 60 door with oblique vertical opening H 60</p> 	L 60	G2135600	264	279	310		
	L 90	G2135900	293	315	374		
<p>anta apertura verticale obliqua H 72 door with oblique vertical opening H 72</p> 	L 60	G2130600	266	283	342		
	L 65	G2130650	276	289	351		
	L 90	G2130900	299	326	399		
<p>anta vetro apertura verticale obliqua H 60 glass door with oblique vertical opening H 60</p> 	telaio alluminio L 60 aluminium frame	G1207600	384	384	384		
	L 90	G1207900	437	437	437		
	telaio melaminico L 60 melamine frame	G1205600	419	—	—		
	L 90	G1205900	476	—	—		
<p>anta vetro apertura verticale obliqua H 72 glass door with oblique vertical opening H 72</p> 	telaio alluminio L 60 aluminium frame	G1202600	402	402	402		
	L 90	G1202900	453	453	453		
	telaio melaminico L 60 melamine frame	G1200600	438	—	—		
	L 90	G1200900	514	—	—		

		COD.	NECK MELAMI- NICO KT5	NECK LACCATO KT6	NECK WOOD KT4			
 <p>pensile H 72 apertura a pacchetto 2 ante H 36 wall unit H 72 lift-up folding door 2 doors H 36</p>	L 45	G2070450	287	302	336			
	L 60	G2070600	297	317	365			
	L 65	G2070650	301	322	374			
	L 90	G2070900	326	355	425			
	L 120	G2071200	394	430	—			
	 <p>pensile H 72 apertura a pacchetto 1 anta chiusa superiore H 36 1 anta vetro inferiore H 36 wall unit H 72 lift-up folding door 1 full upper door H 36 1 glass lower door H 36</p>	telaio alluminio L 45 aluminium frame	G2085450	379	387	407		
L 60		G2085600	400	405	435			
L 90		G2085900	449	458	496			
 <p>pensile H 96 apertura a pacchetto 2 ante H 48 wall unit H 96 lift-up folding door 2 doors H 48</p>		L 45	G2090450	315	334	380		
	L 60	G2090600	328	354	417			
	L 65	G2090650	334	361	430			
	L 90	G2090900	365	402	497			
	 <p>pensile H 96 apertura a pacchetto 1 anta chiusa superiore H 48 1 anta vetro inferiore H 48 wall unit H 96 lift-up folding door 1 full upper door H 48 1 glass lower door H 48</p>	telaio alluminio L 60 aluminium frame	G2097600	428	441	471		
L 90		G2097900	486	505	547			

N.B.: cerniere ammortizzate di serie
 Note: standard blumotion hinges

COD.

NECK MELAMI- NICO KT5	NECK LACCATO KT6	NECK WOOD KT4
--------------------------------	------------------------	---------------------

pensile H 72
1 anta ribalta H 36 apertura TIP-ON
vano per micro Whirlpool
 wall unit H 72
 1 flap door H 36 TIP-ON opening
 housing for Whirlpool microwave



L 60

GPM20600

139

148

191

pensile H 96
1 anta H 60 apertura push-pull
vano per micro Whirlpool
 wall unit H 96
 1 door H 60 push-pull opening
 housing for Whirlpool microwave

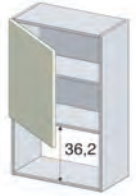

L 60

GPM25601/2

150

165

208

pensile H 96
1 anta vetro H 60 apertura push-pull
vano per micro Whirlpool
 wall unit H 96
 1 glass door H 60 push-pull opening
 housing for Whirlpool microwave

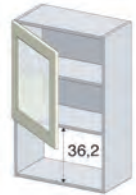

telaio alluminio L 60
 aluminium frame

GPM16601/2





234

234



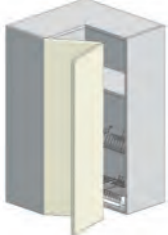

234



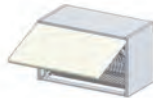
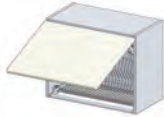
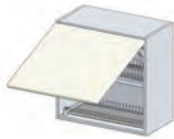
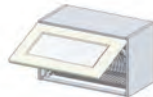
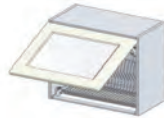
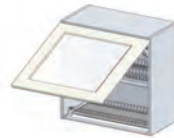

N.B.: cerniere ammortizzate di serie Note: standard blumotion hinges		COD.	NECK	NECK	NECK				
			MELAMI- NICO KT5	LACCATO KT6	WOOD KT4				
 <p>1 anta H 60 1 door H 60</p>	L 60	G3060601/2	127	143	194				
		 <p>1 anta H 72 1 door H 72</p>	L 45	G3010451/2	120	134	185		
L 60	G3010601/2		130	149	212				
L 65	G3010651/2		158	178	228				
 <p>1 anta H 96 1 door H 96</p>	L 45	G3020451/2	141	157	221				
	L 60	G3020601/2	163	187	265				
	L 65	G3020651/2	188	214	276				
 <p>1 anta H 108 1 door H 108</p>	L 45	G3066451/2	177	200	250				
	L 60	G3066601/2	194	222	289				
	L 65	G3066651/2	199	231	304				
 <p>1 anta H 120 1 door H 120</p>	L 45	G3067451/2	200	222	296				
	L 60	G3067601/2	216	246	337				
 <p>1 anta vetro H 60 1 glass door H 60</p>									
		telaio alluminio L 60 aluminium frame telaio melaminico L 60 melamine frame	G3262601/2	228	228	228			
 <p>1 anta vetro H 72 1 glass door H 72</p>									
		telaio alluminio L 45 aluminium frame	G3212451/2	218	218	218			
		L 60	G3212601/2	240	240	240			
		telaio melaminico L 45 melamine frame	G3210451/2	266	—	—			
 <p>1 anta vetro H 96 1 glass door H 96</p>									
		telaio alluminio L 45 aluminium frame	G3222451/2	261	261	261			
		L 60	G3222601/2	293	293	293			
		telaio melaminico L 45 melamine frame	G3220451/2	285	—	—			
	L 60	G3220601/2	334	—	—				



N.B.: cerniere ammortizzate di serie Note: standard blumotion hinges		COD.	NECK	NECK	NECK			
			MELAMI- NICO KT5	LACCATO KT6	WOOD KT4			
 <p>2 ante H 60 2 doors H 60</p>	L 90	G3060900	182	207	283			
		G3010800	182	208	288			
 <p>2 ante H 72 2 doors H 72</p>	L 80 L 90	G3010800	182	208	288			
		G3010900	190	219	308			
		G3020800	211	245	345			
 <p>2 ante H 96 2 doors H 96</p>	L 80 L 90	G3020800	211	245	345			
		G3020900	222	255	370			
 <p>2 ante H 108 2 doors H 108</p>	L 90	G3066900	268	314	418			
		G3212900	388	388	388			
 <p>2 ante vetro H 72 2 glass doors H 72</p>	telaio alluminio L 90 aluminium frame telaio melaminico L 90 melamine frame	G3210900	485	—	—			
		G3222900	462	462	462			
 <p>2 ante vetro H 96 2 glass doors H 96</p>	telaio alluminio L 90 aluminium frame telaio melaminico L 90 melamine frame	G3220900	512	—	—			

N.B.: cerniere ammortizzate di serie Note: standard blumotion hinges		COD.	NECK MELAMI- NICO KT5	NECK LACCATO KT6	NECK WOOD KT4			
 <p>angolo H 72 2 ante a libretto N.B.: non si effettuano fuori squadra corner unit H 72 2 folding doors Note: out-of-plumb units unavailable</p>	65X65	G3450651/2	366	387	464			
 <p>angolo H 96 2 ante a libretto N.B.: non si effettuano fuori squadra corner unit H 96 2 folding doors Note: out-of-plumb units unavailable</p>	65X65	G3460651/2	427	454	544			
 <p>angolo H 108 2 ante a libretto N.B.: non si effettuano fuori squadra corner unit H 108 2 folding doors Note: out-of-plumb units unavailable</p>	65X65	G3463651/2	466	492	572			
 <p>Maggiorazione kit luce LED DUAL COLOR calda (2700K) e naturale (4200K) interruttore ON/OFF "Touch" a sfioramento con alimentatore incluso Surcharge DUAL COLOR LED light kit warm (2700K) and natural (4200K) "Soft Touch" switch ON/OFF with power supplier</p>		opz.005						
	L 45		+100	+100	+100			
	L 60		+105	+105	+105			
	L 65		+105	+105	+105			
	L 80		+115	+115	+115			
	L 90		+115	+115	+115			
	L 120		+135	+135	+135			

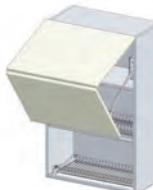
	COD.	NECK MELAMI- NICO KT5	NECK LACCATO KT6	NECK WOOD KT4			
 <p>anta ribalta H 36 griglie orion grau e raccogliocce plastica flap door H 36 orion grau grilles and plastic drip tray</p>	L 60	G3100600	127	138	177		
	L 90	G3100900	160	175	235		
	L 120	G3101205	237	255	—		
 <p>anta ribalta H 48 griglie orion grau e raccogliocce plastica flap door H 48 orion grau grilles and plastic drip tray</p>	L 60	G3120600	145	157	212		
	L 90	G3120900	179	186	259		
	L 120	G3121205	280	306	306		
 <p>anta ribalta H 60 griglie orion grau e raccogliocce plastica flap door H 60 orion grau grilles and plastic drip tray</p>	L 60	G312260C	202	218	286		
	L 90	G312290C	252	276	365		
 <p>anta vetro ribalta H 36 griglie orion grau e raccogliocce plastica glass flap door H 36 orion grau grilles and plastic drip tray</p>	telaio alluminio L 60 aluminium frame	G3132600	243	243	243		
	L 90	G3132900	271	271	271		
 <p>anta vetro ribalta H 48 griglie orion grau e raccogliocce plastica glass flap door H 48 orion grau grilles and plastic drip tray</p>	telaio alluminio L 60 aluminium frame	G3142600	282	282	282		
	L 90	G3142900	323	323	323		
 <p>anta vetro ribalta H 60 griglie orion grau e raccogliocce plastica glass flap door H 60 orion grau grilles and plastic drip tray</p>	telaio alluminio L 60 aluminium frame	G3152600	359	359	359		
	L 90	G3152900	462	462	462		

	COD.	NECK MELAMI- NICO KT5	NECK LACCATO KT6	NECK WOOD KT4			
 <p>anta apertura verticale obliqua H 60 griglie orion grau e raccogliocce plastica door with vertical oblique opening H 60 orion grau grilles and plastic drip tray</p>	L 60	G3123600	266	282	331		
	L 90	G3123900	298	322	392		
 <p>anta apertura verticale obliqua H 72 griglie orion grau e raccogliocce plastica door with vertical oblique opening H 72 orion grau grilles and plastic drip tray</p>	L 60	G3125600	276	294	354		
	L 90	G3125900	303	331	417		
 <p>anta vetro apertura verticale obliqua H 60 griglie orion grau e raccogliocce plastica glass door with vertical oblique opening H 60 orion grau grilles and plastic drip tray</p>	telaio alluminio L 60 aluminium frame	G3207600	379	379	379		
	L 90	G3207900	432	432	432		
	telaio melaminico L 60 melamine frame	G3205600	414	—	—		
	L 90	G3205900	472	—	—		
 <p>anta vetro apertura verticale obliqua H 72 griglie orion grau e raccogliocce plastica glass door with vertical oblique opening H 72 orion grau grilles and plastic drip tray</p>	telaio alluminio L 60 aluminium frame	G3202600	397	397	397		
	L 90	G3202900	447	447	447		
	telaio melaminico L 60 melamine frame	G3200600	433	—	—		
	L 90	G3200900	508	—	—		
 <p>Maggiorazione kit luce LED DUAL COLOR calda (2700K) e naturale (4200K) interruttore ON/OFF "Touch" a sfioramento con alimentatore incluso Surcharge DUAL COLOR LED light kit warm (2700K) and natural (4200K) "Soft Toouch" switch ON/OFF with power supplier</p>	opz.005						
	L 45		+100	+100	+100		
	L 60		+105	+105	+105		
	L 65		+105	+105	+105		
	L 80		+115	+115	+115		
	L 90		+115	+115	+115		
	L 120		+135	+135	+135		

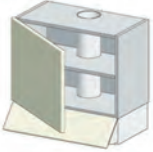
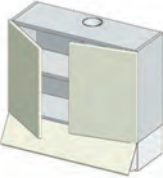
	COD.	NECK MELAMI- NICO KT5	NECK LACCATO KT6	NECK WOOD KT4				
 <p>scolapiatti H 72 apertura a pacchetto 2 ante H 36 griglie orion grau e raccogli gocce plastica plate rack unit H 72 lift-up folding door 2 doors H 36 orion grau grilles and plastic drip tray</p>	L 45	G3081450	289	304	349			
	L 60	G3081600	299	319	377			
	L 90	G3081900	330	360	443			
	L 120	E3082205	493	529	529			
 <p>scolapiatti H 72 apertura a pacchetto 1 anta chiusa superiore H 36 1 anta vetro inferiore H 36 griglie orion grau e raccogli gocce plastica plate rack unit H 72 lift-up folding door 1 full upper door H 36 1 glass lower door H 36 orion grau grilles and plastic drip tray</p>	telaio alluminio L 45 aluminium frame	G3075450	382	392	420			
	L 60	G3075600	402	412	448			
	L 90	G3075900	451	464	514			
 <p>scolapiatti H 96 apertura a pacchetto 2 ante H 48 griglie orion grau e raccogli gocce plastica plate rack unit H 96 lift-up folding door 2 doors H 48 orion grau grilles and plastic drip tray</p>	L 45	G3094450	318	336	394			
	L 60	G3094600	329	356	430			
	L 90	G3094900	369	407	514			
 <p>scolapiatti H 96 apertura a pacchetto 1 anta chiusa superiore H 48 1 anta vetro inferiore H 48 griglie orion grau e raccogli gocce plastica plate rack unit H 96 lift-up folding door 1 full upper door H 48 1 glass lower door H 48 orion grau grilles and plastic drip tray</p>	telaio alluminio L 60 aluminium frame	G3098600	445	458	483			
	L 90	G3098900	504	522	564			
 <p>Maggiorazione kit luce LED DUAL COLOR calda (2700K) e naturale (4200K) interruttore ON/OFF "Touch" a sfioramento con alimentatore incluso Surcharge DUAL COLOR LED light kit warm (2700K) and natural (4200K) "Soft Touch" switch ON/OFF with power supplier</p>	opz.005							
	L 45		+100	+100	+100			
	L 60		+105	+105	+105			
	L 65		+105	+105	+105			
	L 80		+115	+115	+115			
	L 90		+115	+115	+115			
	L 120		+135	+135	+135			

N.B.: cerniere ammortizzate di serie Note: standard blumotion hinges		COD.	NECK MELAMI- NICO KT5	NECK LACCATO KT6	NECK WOOD KT4			
 <p>cappa estraibile 2 motori portata 275 m³/h con laterali in metallo, 1 anta apertura push-pull N.B.: posizionare la cappa ad una distanza non inferiore ai 65 cm dal piano cottura</p> <p>slide-out hood 2 motors air flow rate 275 m³/h with metal sides, 1 door push-pull opening Note: position the hood at least 65 cm from the cooker hob</p>	H 63 L 60	G3600601/2	226	244	324			
	H 87 L 60	G3610601/2	241	264	360			
	n° 2 filtri carbone attivo 2 active carbon filters		+24	+24	+24			
 <p>cappa estraibile 2 motori portata 275 m³/h con laterali in metallo, 2 ante apertura push-pull N.B.: posizionare la cappa ad una distanza non inferiore ai 65 cm dal piano cottura</p> <p>slide-out hood 2 motors air flow rate 275 m³/h with metal sides, 2 doors push-pull opening Note: position the hood at least 65 cm from the cooker hob</p>	H 63 L 90	G3600900	267	294	421			
	H 87 L 90	G3610900	286	322	472			
	n° 2 filtri carbone attivo 2 active carbon filters		+24	+24	+24			
 <p>cappa "Mod. F" integrata totale con frontalino vetro estraibile portata 390 m³/h con faretti a led 1 anta N.B.: posizionare la cappa ad una distanza non inferiore ai 55 cm dal piano cottura</p> <p>"Mod. F" fully integrated hood with glass pull-out frontal panel air flow rate 390 m³/h, with led lights 1 door Note: position the hood at least 55 cm from the cooker hob</p>	H 60 L 60	GPC90461/2	462	476	495			
	H 72 L 60	GPC90561/2	469	487	510			
	H 96 L 60	GPC90661/2	497	520	559			
	H 108 L 60	GPC90761/2	515	541	583			
	n° 2 filtri carbone attivo 2 active carbon filters	08750894	31	31	31			
 <p>cappa "Mod. F" integrata totale con frontalino vetro estraibile portata 390 m³/h con faretti a led 2 ante N.B.: posizionare la cappa ad una distanza non inferiore ai 55 cm dal piano cottura</p> <p>"Mod. F" fully integrated hood with glass pull-out front panel air flow rate 390 m³/h with led lights 2 doors Note: position the hood at least 55 cm from the cooker hob</p>	H 60 L 90	GPC90490	533	556	584			
	H 72 L 90	GPC90590	543	571	607			
	H 96 L 90	GPC90690	573	606	668			
	H 108 L 90	GPC90790	601	655	710			
	n° 2 filtri carbone attivo 2 active carbon filters	08750894	31	31	31			

N.B.: cerniere ammortizzate di serie

Note: standard blumotion hinges

cappa "Mod. F" integrata totale con frontalino vetro estraibile portata 390 m³/h con faretti a led
1 anta apertura a ribalta
N.B.: posizionare la cappa ad una distanza non inferiore ai 55 cm dal piano cottura

"Mod. F" fully integrated hood with glass pull-out front panel
 air flow rate 390 m³/h with led lights
 1 flap door
Note: position the hood at least 55 cm from the cooker hob

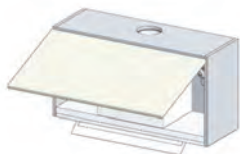

	COD.	NECK MELAMINICO KT5	NECK LACCATO KT6	NECK WOOD KT4			
H 36 L 60	GPC80260	467	476	494			
H 36 L 90	GPC80290	522	537	560			
H 36 L 120	GPC80320	616	634	—			
H 48 L 60	GPC80360	507	507	689			
H 48 L 90	GPC80390	553	571	745			
H 48 L 120	GPC80420	791	818	—			
H 60 L 60	GPC80460	631	647	588			
H 60 L 90	GPC80490	713	735	676			
n° 2 filtri carbone attivo 2 active carbon filters	08750894	31	31	31			

cappa "Mod. F" integrata totale con frontalino vetro estraibile portata 390 m³/h con faretti a led
2 ante apertura a pacchetto
N.B.: posizionare la cappa ad una distanza non inferiore ai 55 cm dal piano cottura

"Mod. F" fully integrated hood with glass pull-out front panel
 air flow rate 390 m³/h with led lights
 2 lift-up folding doors
Note: position the hood at least 55 cm from the cooker hob

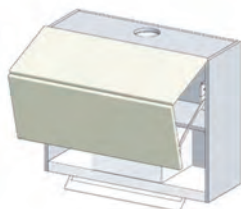

H 72 L 60	GPC83560	640	660	692			
H 72 L 90	GPC83590	693	721	769			
H 72 L 120	GPC83620	808	844	—			
H 96 L 60	GPC83660	673	698	748			
H 96 L 90	GPC83690	734	771	843			
n° 2 filtri carbone attivo 2 active carbon filters	08750894	31	31	31			

cappa "Mod. F" integrata totale con frontalino vetro estraibile portata 390 m³/h
1 anta apertura verticale obliqua
N.B.: posizionare la cappa ad una distanza non inferiore ai 55 cm dal piano cottura

"Mod. F" fully-integrated hood with glass pull-out front panel
 flow rate 390 m³/h with led lights
 1 door with vertical oblique opening
Note: position the hood at least 55 cm from the cooker hob

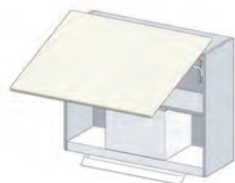

H 60 L 60	GPC86460	617	632	645			
H 60 L 90	GPC86490	671	693	716			
H 72 L 60	GPC86560	629	648	668			
H 72 L 90	GPC86590	679	706	741			
n° 2 filtri carbone attivo 2 active carbon filters	08750894	31	31	31			

N.B.: cerniere ammortizzate di serie
Note: standard blumotion hinges

Maggiorazione
cappa "NO DRIP" incasso pensile
portata 600 m³/h, per piano cottura ad
induzione
classe energetica A

Surcharge
"NO DRIP" built in hood air flow rate 600 m³/h
recommended for induction cooker hob
energetic class A



L 60

opz.006

+559

+559

+559

L 90

opz.006

+559

+559

+559

L 120

opz.006

+676

+676

—

filtro carbone attivo
active carbon filter

08750844R

+42







+42





+42

PERCHÈ LA CAPP A "NO DRIP":
a differenza dei tradizionali piani cottura a
gas dove la fiamma riscalda le superfici della
cappa, nei piani cottura ad induzione i vapori
condensano velocemente sulle superfici
"fredde" della stessa, generando così gocce
d'acqua che cadono sul p.c. sottostante.
**LA CAPP A "NO DRIP" È LA SOLUZIONE A
QUESTO PROBLEMA.**



WHY THE "NO DRIP" HOOD:
unlike traditional gas hobs where the flame heats the
surfaces of the hood, with induction hobs the vapors
quickly condense on the "cold" surfaces of the hood, thus
generating drops of water that fall on the hob below.
THE "NO DRIP" HOOD IS THE SOLUTION TO THIS
PROBLEM.

Le basi non sono comprensive di top - N.B.: cerniere ammortizzate di serie The base units do not include the tops - Note: standard blumotion hinges		COD.	NECK MELAMI- NICO KT5	NECK LACCATO KT6	NECK WOOD KT4			
 <p>fascia tamponamento filler panel</p>								
	L da 3 a 15 size from 3 to 15	G4800000	54	60	80			
 <p>jolly base L da 10 a 30 jolly base unit size from 10 to 30</p>								
	colore come struttura same colour as carcass	G4700000	130	130	130			
	melaminico come anta melamine same as door	G4700030	180	—	—			
	impiallacciato come anta (folding) veneered same as door (folding)	G4707520	—	—	568			
 <p>1 anta 1 door</p>								
	L 15	G4010151/2	112	119	138			
	L 30	G4010301/2	121	132	157			
	L 40	G4010401/2	132	146	181			
	L 45	G4010451/2	138	157	196			
	L 60	G4010601/2	157	180	233			
	L 65	G4010651/2	170	191	247			
 <p>2 ante 2 doors</p>								
	L 60	G4010600	182	203	256			
	L 80	G4010800	208	235	303			
	L 90	G4010900	222	252	328			
 <p>cestello estraibile chiusura soft pull-out basket unit soft-closing system</p>								
	L 15	G4150150	141	149	169			
	L 30	G4150300	184	202	232			
	L 45	G4150450	207	229	274			
 <p>4 cassetti H 16,9 4 drawers H 16,9</p>								
	L 30	G4100300	299	320	383			
	L 40	G4100400	316	340	411			
	L 45	G4100450	328	353	430			
	L 60	G4100600	364	397	483			

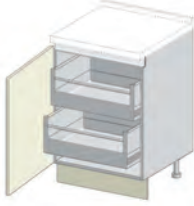
Le basi non sono comprensive di top - N.B.: cassetti e cestoni ad estrazione totale con blumotion The base units do not include the tops - Note: fully extending drawers and deep drawers with blumotion system		COD.	NECK	NECK	NECK				
			MELAMI- NICO KT5	LACCATO KT6	WOOD KT4				
 <p>2 cassetti H 16,9 1 cestone H 34,2 2 drawers H 16,9 1 deep drawer H 34,2</p>	L 45	G4130450	282	305	379				
	L 60	G4130600	313	342	428				
	L 90	G4130900	381	425	531				
	L 120	G4131200	558	576	—				
 <p>4 cassetti H 16,9 1 cestone H 34,2 4 drawers H 16,9 1 deep drawer H 34,2</p>	L 90	G4300900	512	550	696				
 <p>portaposate in plastica per cassetti plastic cutlery tray for drawers</p>	L 30	08700030X	10	10	10				
	L 40	08700040X	10	10	10				
	L 45	08700050X	10	10	10				
	L 60	08700060X	11	11	11				
	divisori regolabili L 90 adjustable separators	L 90	08700070X	32	32	32			
	divisori regolabili L 120 adjustable separators	L 120	08700075X	40	40	40			
 <p>2 cestoni H 34,2 2 deep drawers H 34,2</p>	L 45	G4170450	245	268	332				
	L 60	G4170600	273	304	379				
	L 90	G4170900	334	376	473				
	L 120	G4171200	497	519	—				
 <p>1 anta 2 cassetti interni 1 cestone interno posizionare a 5 cm dalla parete laterale 1 door 2 internal drawers 1 internal deep drawer place at 5 cm from the side wall</p>	L 45	G4210461/2	332	352	412				
	L 60	G4210611/2	362	387	464				
 <p>1 anta 2 cestoni interni posizionare a 5 cm dalla parete laterale 1 door 2 internal deep drawers place at 5 cm from the side wall</p>	L 45	G4210471/2	290	311	368				
	L 60	G4210621/2	318	343	417				

Le basi non sono comprensive di top - N.B.: cassetti e cestoni ad estrazione totale con blumotion
 The base units do not include the tops - Note: fully extending drawers and deep drawers with blumotion system

COD.

NECK
MELAMI-
NICO
KT5

NECK
LACCATO
KT6

NECK
WOOD
KT4

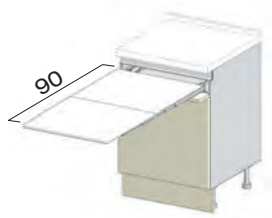

base tavolo estraibile LUNCH
portata 60 kg
1 frontale H 16,9
1 anta H 54,5 apertura push-pull
 base unit with pull-out table LUNCH
 load capacity kg 60
 1 front H 16,9
 1 door H 54,5 push-pull opening

L 60

G4230601/2

644

663

739



base tavolo estraibile LUNCH
portata 60 kg
1 frontale H 16,9
2 ante H 54,5 apertura push-pull
 base unit with pull-out table LUNCH
 load capacity kg 60
 1 front H 16,9
 2 doors H 54,5 push-pull opening

L 90

G4230900

686



712

818

BASI ANGOLO

CORNER BASE UNITS

H 88 P 65

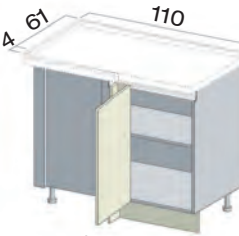
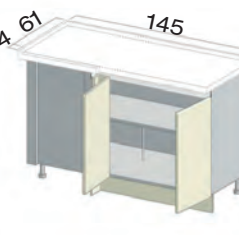
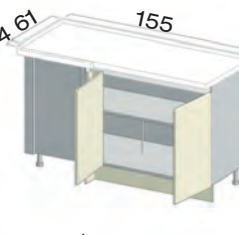
Le basi non sono comprensive di top - N.B.: cerniere ammortizzate di serie The base units do not include the tops - Note: standard blumotion hinges		COD.	NECK MELAMI- NICO KT5	NECK LACCATO KT6	NECK WOOD KT4			
 <p>angolo L 95 1 ripiano 1 anta L 30 (cerniere a pilastro) cassone 90 corner unit W 95 1 shelf 1 door W 30 (pillar hinges) structure 90</p> <p>verso dx RH version</p>	95x65	G4400951/2	298	307	350			
 <p>angolo L 105 1 ripiano 1 anta L 40 (cerniere a pilastro) cassone 90 corner unit W 105 1 shelf 1 door W 40 (pillar hinges) structure 90</p> <p>verso dx RH version</p>	105x65	G4401041/2	306	318	367			
 <p>angolo L 110 1 ripiano 1 anta L 45 (cerniere a pilastro) cassone 105 corner unit W 110 1 shelf 1 door W 45 (pillar hinges) structure 105</p> <p>verso dx RH version</p>	110x65	G4401091/2	325	339	394			
 <p>angolo L 125 1 ripiano 1 anta L 60 (cerniere a pilastro) cassone 120 con tirante corner unit W 125 1 shelf 1 door W 60 (pillar hinges) structure 120 with tie beam</p> <p>verso dx RH version</p>	125x65	G4401241/2	353	370	437			
 <p>angolo L 145 1 ripiano 2 ante L 40 (cerniere a pilastro) cassone 140 con tirante corner unit W 145 1 shelf 2 doors W 40 (pillar hinges) structure 140 with tie beam</p> <p>verso dx RH version</p>	145x65	G4401451/2	401	412	518			
 <p>angolo L 155 1 ripiano 2 ante L 45 (cerniere a pilastro) cassone 150 con tirante corner unit W 155 1 shelf 2 doors W 45 (pillar hinges) structure 150 with tie beam</p> <p>verso dx RH version</p>	155x65	G4401551/2	414	428	539			

BASI ANGOLO

CORNER BASE UNITS

H 88 P 65

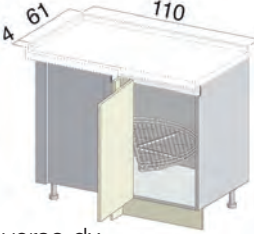
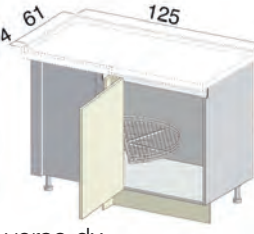
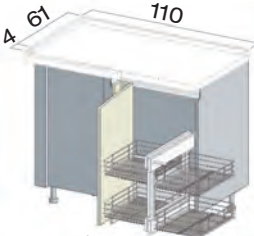
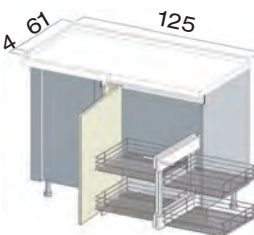
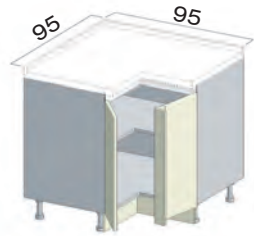
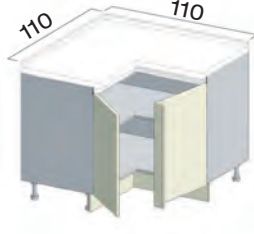



Le basi non sono comprensive di top - N.B.: cerniere ammortizzate di serie The base units do not include the tops - Note: standard blumotion hinges		COD.	NECK MELAMI- NICO KT5	NECK LACCATO KT6	NECK WOOD KT4			
 <p>angolo L 110 cestello mezzaluna orion grau 1 anta L 45 (cerniere a pilastro) cassone 105 corner unit W 110 crescent-shaped orion grau wire basket unit 1 door W 45 (pillar hinges) structure 105</p> <p>verso dx RH version</p>	<p>1 cestello 110x65 1 basket drawer</p>	G4401101/2	325	339	394			
	<p>2 cestelli 110x65 2 basket drawers</p>	G4401111/2	352	366	424			
 <p>angolo L 125 cestello mezzaluna orion grau 1 anta L 60 (cerniere a pilastro) cassone 120 corner unit W 125 crescent-shaped orion grau wire basket units 1 door W 60 (pillar hinges) structure 120</p> <p>verso dx RH version</p>	<p>1 cestello 125x65 1 basket drawer</p>	G4401251/2	343	360	437			
	<p>2 cestelli 125x65 2 basket drawers</p>	G4401261/2	370	388	457			
 <p>angolo L 110 4 cestelli orion grau estraibili indipendenti dall'anta 1 anta L 45 (cerniere a pilastro) cassone 105 corner unit W 110 4 pull-out orion grau basket units opening independently from door 1 door W 45 (pillar hinges) structure 105</p> <p>verso dx RH version</p>		G4451101/2	835	849	914			
	110x65							
 <p>angolo L 125 4 cestelli orion grau estraibili indipendenti dall'anta 1 anta L 60 (cerniere a pilastro) cassone 120 corner unit W 125 4 pull-out orion grau basket units opening independently from door 1 door W 60 (pillar hinges) structure 120</p> <p>verso dx RH version</p>		G4451251/2	903	920	990			
	125x65							
 <p>angolo 95x95 1 ripiano 2 ante L 30 (cerniere 180°) angolare unito all'anta dx corner unit 95x95 1 shelf 2 doors W 30 (180° hinges) angular filler attached to the RH door</p>		G4480950	606	629	668			
	95x95							
 <p>angolo 110x110 1 ripiano 2 ante L 45 (cerniere 180°) angolare unito all'anta dx corner unit 110x110 1 shelf 2 doors W 45 (180° hinges) angular filler attached to the RH door</p>		G4481100	643	675	754			
	110x110							

BASI ANGOLO PANNELLO COME ANTA

H 88 P 61

CORNER BASE UNITS PANEL AS DOOR

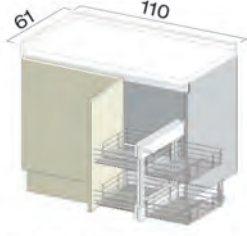
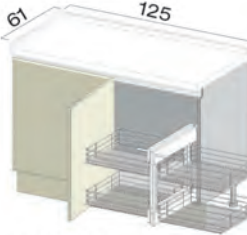
LE BASI NON SONO COMPRENSIVE DI TOP
THE BASE UNITS DO NOT INCLUDE THE TOPS

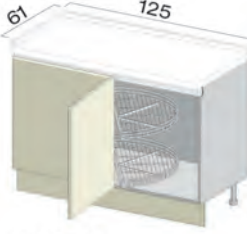



		COD.	NECK MELAMI- NICO KT5	NECK LACCATO KT6	NECK WOOD KT4			
 <p>angolo L 110 1 ripiano 1 anta L 45 pannello come anta cassone 110 corner unit W 110 1 shelf 1 door W 45 panel as door structure 110</p> <p>verso dx RH version</p>								
	110x61	G4403091/2	327	368	460			
 <p>angolo L 125 1 ripiano 1 anta L 60 pannello come anta cassone 125 con tirante corner unit W 125 1 shelf 1 door W 60 panel as door structure 125 with tie beam</p> <p>verso dx RH version</p>								
	125x61	G4403241/2	342	374	502			
 <p>angolo L 110 4 cestelli orion grau estraibili indipendenti dall'anta 1 anta L 45 pannello come anta cassone 110 corner unit W 110 4 pull-out orion grau basket units opening independently from door 1 door W 45 panel as door structure 110</p> <p>verso dx RH version</p>								
	110x61	G4453101/2	837	878	976			
 <p>angolo L 125 4 cestelli orion grau estraibili indipendenti dall'anta 1 anta L 60 pannello come anta cassone 125 corner unit W 125 4 pull-out orion grau basket units opening independently from door 1 door W 60 panel as door structure 125</p> <p>verso dx RH version</p>								
	125x61	G4453251/2	902	934	1.044			
 <p>angolo L 110 2 cestelli mezzaluna orion grau 1 anta L 45 pannello come anta cassone 110 corner unit W 110 2 crescent-shaped orion grau wire basket units 1 door W 45 panel as door structure 110</p> <p>verso dx RH version</p>								
	110x61	G4403111/2	349	390	486			
 <p>angolo L 125 2 cestelli mezzaluna orion grau 1 anta L 60 pannello come anta cassone 125 corner unit W 125 2 crescent-shaped orion grau wire basket units 1 door W 60 panel as door structure 125</p> <p>verso dx RH version</p>								
	125x61	G4403261/2	360	406	511			

BASI PER FORNI

H 88 P 61

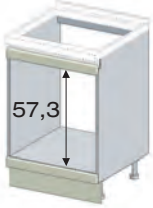
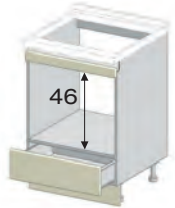
OVEN BASE UNITS

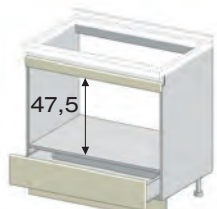





Le basi non sono comprensive di top - N.B.: cassetti ad estrazione totale con blumotion
The base units do not include the tops - Note: fully extending drawers with blumotion system

	COD.	NECK MELAMI- NICO KT5	NECK LACCATO KT6	NECK WOOD KT4			
 <p>base per forno elettrico e gas H 60 fascia superiore e inferiore H 5,7 electric and gas oven base unit H 60 upper and lower panel H 5,7</p>	L 60	G5510600	151	158	158		
	 <p>base per forno elettrico H 46 fascia superiore H 8,9 cassetto inferiore H 16,9 presa su fondo electric oven base unit H 46 upper panel H 8,9 lower drawer H 16,9 grip on bottom opening</p>	L 60	G5530600	202	213	160	
 <p>base per maxiforno H 60 fascia superiore e inferiore H 5,7 maxi-oven base unit H 60 upper and lower panel H 5,7</p>		L 90	G5510900	183	193	222	
	 <p>base per maxiforno H 48 fascia superiore H 6,7 cassetto inferiore H 16,9 presa su fondo maxi-oven base unit H 48 upper panel H 6,7 lower drawer H 16,9 grip on bottom opening</p>	L 90	G5530900	262	276	198	
 <p>kit raccordo base angolo junction kit for corner base unit</p>		110x110	G5471100	228	242	234	
	 <p>kit raccordo base angolo per inserimento lavastoviglie a destra o sinistra junction kit for corner base unit for dishwasher placed on the right or the left side</p> <p>verso dx RH version</p>	110x110	G5471151/2	260	275	272	

BASI PER PIANI COTTURA

COOKER HOB BASE UNITS

H 88 P 61

Le basi non sono comprensive di top The base units do not include the tops		COD.	NECK MELAMI- NICO KT5	NECK LACCATO KT6	NECK WOOD KT4			
 <p>base predisposta piano cottura 1 anta base unit configured for cooker hob 1 door</p>	L 60	G5500601/2	161	188	233			
	<p>mag.base piano cottura ad induzione surcharge base unit for induction cooker hob</p>		opz.101	+55	+55	+55		
 <p>base predisposta piano cottura 2 ante base unit configured for cooker hob 2 doors</p>	L 90	G5500900	222	261	328			
	<p>mag.base piano cottura ad induzione surcharge base unit for induction cooker hob</p>		opz.101	+55	+55	+55		
 <p>Maggiorazione per base predisposta piano cottura ad induzione con lamierino di protezione N.B.: realizzabile su base 2 cassetti+1 cestone, base 2 cestoni e base 4 cassetti Surcharge for base unit configured for induction cooker hob with protection metal sheet Note: available on base unit 2 drawers+1 deep drawer, base unit 2 deep drawers and base unit 4 drawers</p>		opz.101	+55	+55	+55			
 <p>base predisposta piano cottura con cappa integrata 1 frontale superiore fisso H 16,9 1 cassetto H 16,9 P 40 1 cestone H 34,2 P 40 base unit configured for cooker hob with integrated hood 1 fixed upper front H 16,9 1 drawer H 16,9 D 40 1 deep drawer H 34,2 D 40</p>	L 90	G5509090	379	414	490			
	L 120	G5509120	550	574	—			
 <p>base predisposta piano cottura con cappa integrata 2 cestoni H 34,2 P 40 base unit configured for cooker hob with integrated hood 2 deep drawers H 34,2 D 40</p>	L 90	G5509095	382	410	488			
	L 120	G5509125	574	608	—			
 <p>Esempio di piano cottura con cappa integrata Example of cooker hob with integrated hood</p>								

SOTTOLAVELLI

SINK BASE UNITS

H 88 P 61

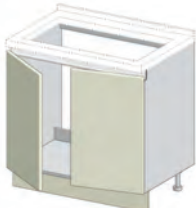
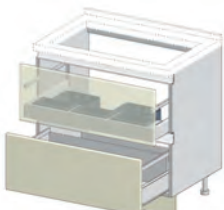
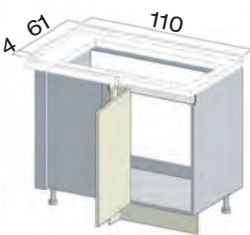
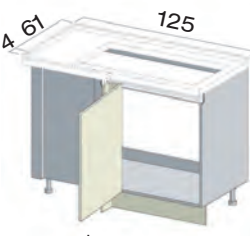
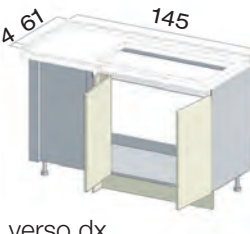
Le basi non sono comprensive di top - N.B.: cerniere ammortizzate di serie The base units do not include the tops - Note: standard blumotion hinges		COD.	NECK	NECK	NECK			
			MELAMI- NICO KT5	LACCATO KT6	WOOD KT4			
 <p>sottolavello 1 anta sink base unit 1 door</p>	L 45	G5010451/2	139	154	195			
	L 60	G5010601/2	156	176	230			
 <p>sottolavello 2 ante sink base unit 2 doors</p>	L 60	G5010600	176	197	251			
	L 80	G5010800	204	231	300			
	L 90	G5010900	214	244	322			
	L 120	G5011200	253	290	392			
 <p>sottolavello 2 cestoni H 34,2 cestone superiore sagomato con vaschette sink base unit 2 deep drawers H 34,2 contoured upper deep drawer with trays</p>	L 60	G5200600	312	335	408			
	L 90	G5200900	375	407	513			
	L 120	G5201200	523	545	—			
 <p>sottolavello angolo L 110 1 anta L 45 (cerniere pilastro) cassone 105 corner sink base unit W 110 1 door W 45 (pillar hinges) structure 105</p> <p>verso dx RH version</p>	110x65	G4421101/2	296	309	371			
 <p>sottolavello angolo L 125 1 anta L 60 (cerniere pilastro) cassone 120 corner sink base unit W 125 1 door W 60 (pillar hinges) structure 120</p> <p>verso dx RH version</p>	125x65	G4421251/2	317	335	402			
 <p>sottolavello angolo L 145 2 ante L 40 (cerniere pilastro) cassone 140 corner sink base unit W 145 2 doors W 40 (pillar hinges) structure 140</p> <p>verso dx RH version</p>	145x65	G4421451/2	348	373	469			

SOTTOLAVELLI

H 88 P 61

SINK BASE UNITS

Le basi non sono comprensive di top - N.B.: cerniere ammortizzate di serie
 The base units do not include the tops - Note: standard blumotion hinges



verso dx
RH version

sottolavello angolo L 155
2 ante L 45 (cerniere pilastro)
cassone 150
 corner sink base unit W 155
 2 doors W 45 (pillar hinges)
 structure 150

155x65

COD.	NECK MELAMI- NICO KT5	NECK LACCATO KT6	NECK WOOD KT4			
G4421551/2	372	400	496			

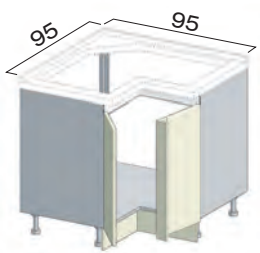

sottolavello angolo 95x95
2 ante L 30 (cerniere 180°)
angolare unito all'anta dx
 corner sink base unit 95x95
 2 doors W 30 (180° hinges)
 angular filler attached to the RH door

95x95

G5020950	541	560	655			
----------	-----	-----	-----	--	--	--

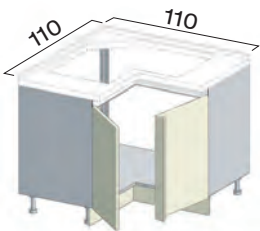

sottolavello angolo 110x110
2 ante L 45 (cerniere 180°)
angolare unito all'anta dx
 corner sink base unit 110x110
 2 doors W 45 (180° hinges)
 angular filler attached to the RH door

110x110





G5021100	577	604	745			
----------	-----	-----	-----	--	--	--

**NELLE INTERRUZIONI DI GOLA, AGGIUNGERE
 SEMPRE I RELATIVI TERMINALI**
 ADD.THE ASSOCIATED CLOSURES TO ANY
 INTERRUPTIONS IN THE FINGER RAIL

BASI PER ELETTRODOMESTICI SOTTOTOP

H 88 P 61

BASE UNITS FOR UNDER-TOP APPLIANCES

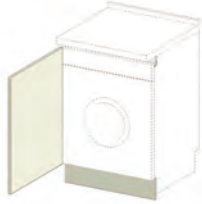

Le basi non sono comprensive di top The base units do not include the tops		COD.	NECK MELAMI- NICO KT5	NECK LACCATO KT6	NECK WOOD KT4			
 <p>anta per lavastoviglie scomparsa totale completa di kit protezione fianchi door for fully integrated dishwasher with protection kit for side panels</p>	L 45	G4490080	77	92	137			
	L 60	G4490090	81	101	162			
 <p>anta per lavastoviglie a scomparsa totale estetica 2 cestoni completa di kit protezione fianchi door for aesthetic fully integrated dishwasher 2 deep drawers with protection kit for side panels</p>	L 60	G4490300	213	231	376			
 <p>kit protezione fianchi per lavastoviglie protection kit for side panels for dishwasher</p> 								
 <p>anta per lavabiancheria scomparsa totale door for fully integrated washing machine</p>	L 60	G4490011/2	97	117	162			

BASI PER ELETTRODOMESTICI SOTTOTOP

H 88 P 61

BASE UNITS FOR UNDER-TOP APPLIANCES





Le basi non sono comprensive di top
The base units do not include the tops

	COD.	NECK MELAMI- NICO KT5	NECK LACCATO KT6	NECK WOOD KT4				
 <p>anta con fianco per frigo e congelatore sottotop door with side panel for under-top fridge and freezer</p>								
	L 60 G4490151/2	122	142	182				
 <p>anta per frigo e congelatore sottotop door for under-top fridge and freezer</p>								
	L 60 G4490181/2	97	117	162				
 <p>fianco per elettrodomestici a fine composizione side panel for appliances placed at the end of the composition</p>								
	H 88x59,6x1,8 zoccolo H 13 in nobilitato melamine coated	G94612	29	29	29			
	H 88x59,6x1,8 zoccolo H 13 come anta same as door	G94704	49	—	122			
	H 88x59,7x1,9 zoccolo H 13 laccato come anta lacquered same as door	G947041	—	75	—			

BASI H 76

BASE UNITS H 76

H 76 P 61

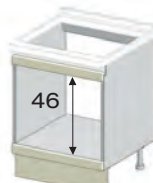

Le basi non sono comprensive di top - N.B.: cerniere ammortizzate di serie The base units do not include the tops - Note: standard blumotion hinges		COD.	NECK MELAMI- NICO KT5	NECK LACCATO KT6	NECK WOOD KT4			
 <p>base H 76 1 anta base unit H 76 1 door</p>	L 45	G4030451/2	143	156	187			
	L 60	G4030601/2	164	181	225			
 <p>base H 76 2 ante base unit H 76 2 doors</p>	L 90	G4030900	227	252	317			
	L 120	G4031200	262	294	400			
 <p>base H 76 1 cassetto H 22,2 2 cassetti H 16,9 base unit H 76 1 drawer H 22,2 2 drawers H 16,9</p>	L 45	G4255450	274	296	355			
	L 60	G4255600	307	350	414			
	L 90	G4255900	387	424	516			
	L 120	G4256200	524	583	—			
 <p>base H 76 1 cassetto H 22,2 1 cassetto H 34,2 base unit H 76 1 drawer H 22,2 1 deep drawer H 34,2</p>	L 45	G4260450	228	249	302			
	L 60	G4260600	257	299	354			
	L 90	G4260900	327	362	445			
	L 120	G4261200	434	483	—			
 <p>base H 76 predisposta per forno elettrico compatto H 46 1 fascia superiore H 7,4 1 fascia inferiore H 5,5 base unit H 76 configured for compact electric oven H 46 1 upper panel H 7,4 1 lower panel H 5,5</p>	L 60	G5540600	155	162	170			

SOTTOLAVELLI H 76

H 76 P 61

SINK BASE UNITS H 76

Le basi non sono comprensive di top - N.B.: cerniere ammortizzate di serie
 The base units do not include the tops - Note: standard blumotion hinges







	COD.	NECK MELAMI- NICO KT5	NECK LACCATO KT6	NECK WOOD KT4			
 <p>sottolavello H 76 1 anta sink base unit H 76 1 door</p>	L 45	G5060451/2	155	168	195		
	L 60	G5060601/2	171	188	226		
 <p>sottolavello H 76 2 ante sink base unit H 76 2 doors</p>	L 90	G5060900	235	260	319		
	L 120	G5061200	271	303	382		
 <p>sottolavello H 76 1 cestone H 59,7 con scarico salvaspazio sink base unit H 76 1 deep drawer H 59,7 with space-saver drain piping</p>	L 60	G5260600	241	258	309		
	L 90	G5260900	282	307	377		
	L 120	G5261200	366	392	—		
<p>NELLE INTERRUZIONI DI GOLA, AGGIUNGERE SEMPRE I RELATIVI TERMINALI ADD. THE ASSOCIATED CLOSURES TO ANY INTERRUPTIONS IN THE FINGER RAIL</p>							

BASI SOSPESSE con Attaccaglie e Barre Fissaggio a parete

H 37,5 - 51 - 63 P 61

HANGING BASE UNITS with Hangers and Rods for wall mounting



Le basi non sono comprensive di top - N.B.: cerniere ammortizzate di serie
 The base units do not include the tops - Note: standard blumotion hinges

	COD.	NECK MELAMI- NICO KT5	NECK LACCATO KT6	NECK WOOD KT4			
 <p>base H 37,5 1 anta H 34,2 base unit H 37,5 1 door H 34,2</p>	L 45	G4321451/2	146	154	172		
	L 60	G4321601/2	156	167	193		
 <p>base H 51 1 anta H 47,7 base unit H 51 1 door H 47,7</p>	L 45	G4320451/2	160	171	195		
	L 60	G4320601/2	173	186	223		
 <p>base H 63 1 anta H 59,7 base unit H 63 1 door H 59,7</p>	L 45	G4322451/2	162	176	207		
	L 60	G4322601/2	176	193	238		
 <p>base H 37,5 2 ante H 34,2 base unit H 37,5 2 doors H 34,2</p>	L 90	G4321900	198	215	254		
	L 120	G4322200	223	244	292		
 <p>base H 51 2 ante H 47,7 base unit H 51 2 doors H 47,7</p>	L 90	G4320900	223	244	298		
	L 120	G4321200	254	281	365		
 <p>base H 63 2 ante H 59,7 base unit H 63 2 doors H 59,7</p>	L 90	G4322900	230	255	321		

BASI SOSPENSE con Attaccaglie e Barre Fissaggio a parete

H 37,5 - 51 - 63 P 61

HANGING BASE UNITS with Hangers and Rods for wall mounting

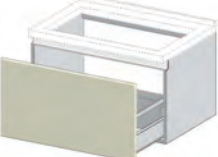
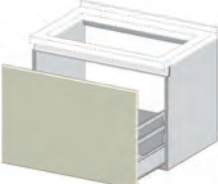
Le basi non sono comprensive di top - N.B.: cassetti e cestoni ad estrazione totale con blumotion The base units do not include the tops - Note: fully extending drawers and deep drawers with blumotion system		COD.	NECK	NECK	NECK			
			MELAMI- NICO KT5	LACCATO KT6	WOOD KT4			
 <p>base H 37,5 1 cestone H 34,2 base H 37,5 1 deep drawer H 34,2</p>	L 45	G4311450	190	200	229			
	L 60	G4311600	204	216	255			
	L 90	G4311900	241	258	310			
	L 120	G4312200	281	305	—			
 <p>base H 51 1 cestone H 47,7 base unit H 51 1 deep drawer H 47,7</p>	L 45	G4310450	193	205	243			
	L 60	G4310600	208	222	272			
	L 90	G4310900	243	263	331			
	L 120	G4311200	288	316	—			
 <p>base H 63 1 cestone H 59,7 1 cassetto interno base unit H 63 1 deep drawer H 59,7 1 internal drawer</p>	L 45	G4312450	289	303	353			
	L 60	G4312600	311	328	394			
	L 90	G4312900	363	388	474			
 <p>sottolavello H 51 1 cestone sagomato H 47,7 scarico salvaspazio sink base unit H 51 1 contoured deep drawer H 47,7 space-saver drain piping</p>	L 90	G5240900	290	311	376			
 <p>sottolavello H 63 1 cestone H 59,7 scarico salvaspazio sink base unit H 63 1 deep drawer H 59,7 with space-saver drain piping</p>	L 60	G5250600	259	276	326			
	L 90	G5250900	299	324	388			
	L 120	G5251200	340	370	—			

COMPOSIZIONE CON ELEMENTI INCLINATI

COMPOSITION WITH INCLINED ELEMENTS

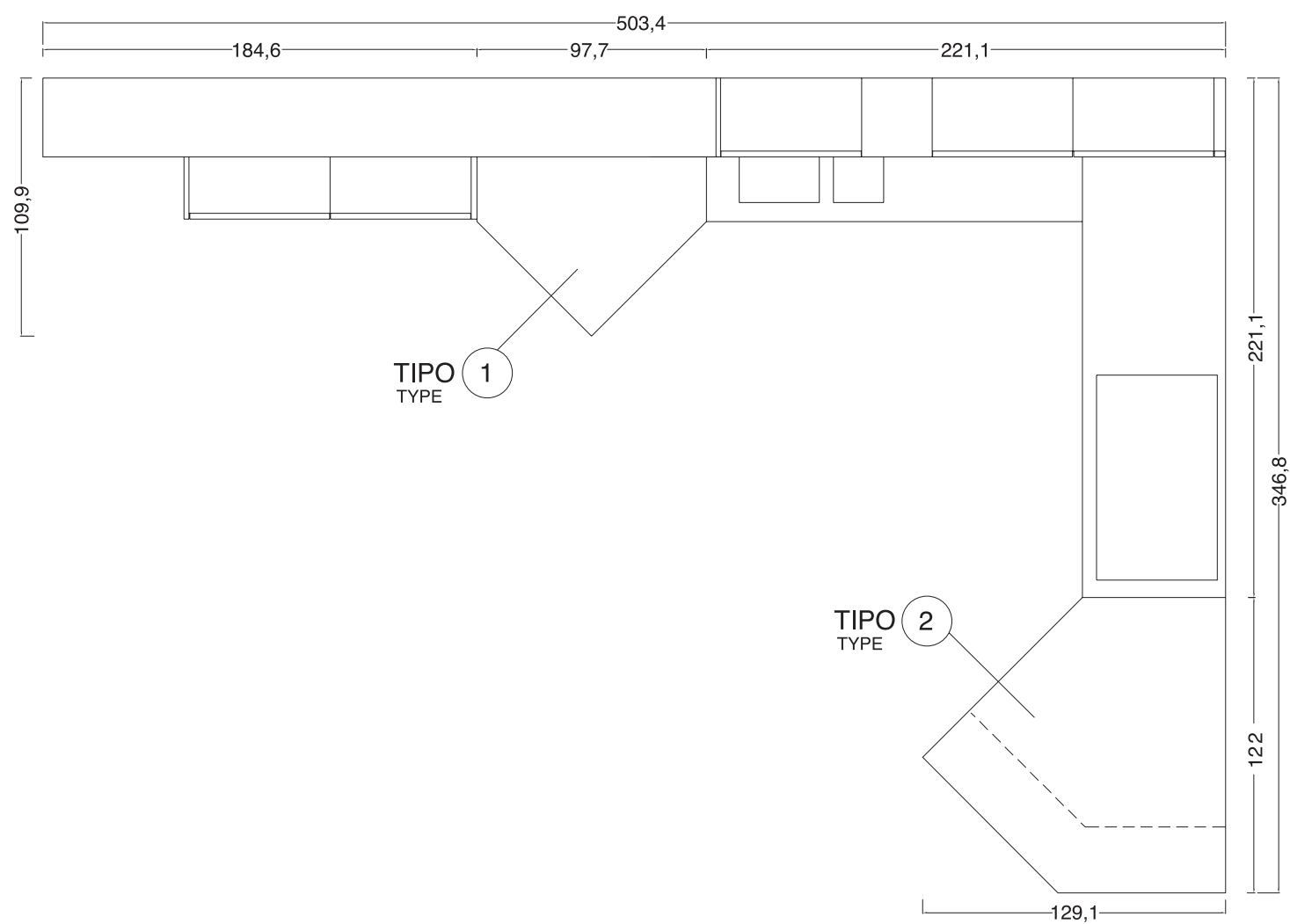
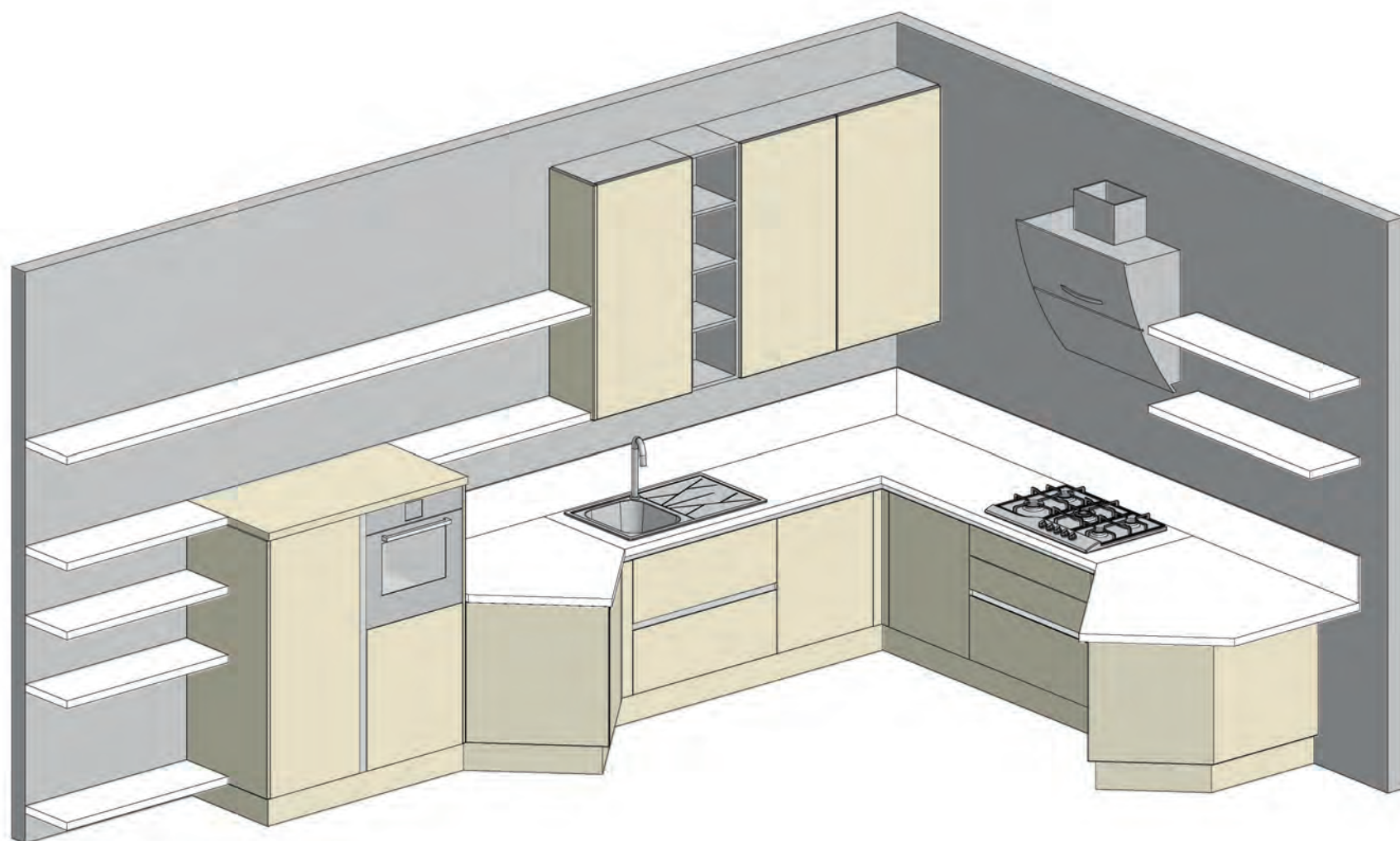

BASE INCLINATA "TIPO 1"

INCLINED BASE UNIT "TYPE 1"

LE BASI NON SONO COMPRENSIVE DI TOP
THE BASE UNITS DO NOT INCLUDE THE TOPS

kit base inclinata "tipo 1" per vano L 60
inclined base unit "type 1" kit W 60

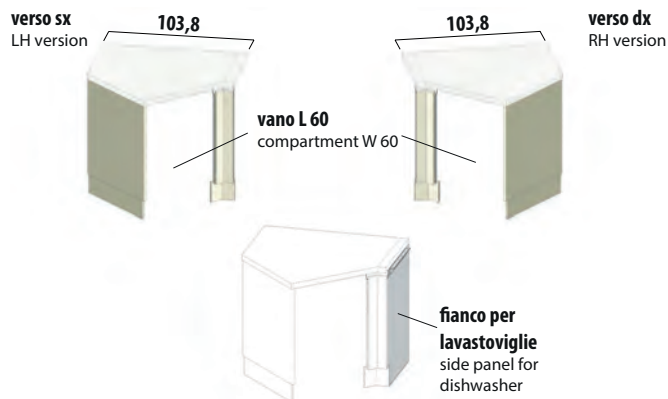

kit "tipo 1"
"type 1" kit

mag. inserimento fianco per lavastoviglie dx o sx
surcharge for dishwasher side panel placed on RH or LH side

top per base inclinata "tipo 1"
worktop for inclined base unit "type 1"

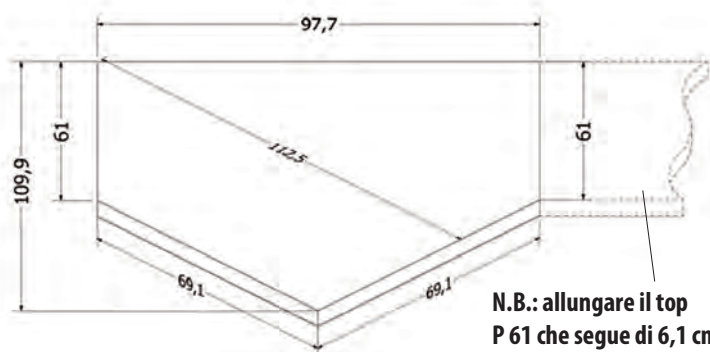

verso sx
LH version

N.B.: allungare il top P 61 che segue di 6,1 cm
Note: add. 6,1 cm to the worktop next to the inclined base unit

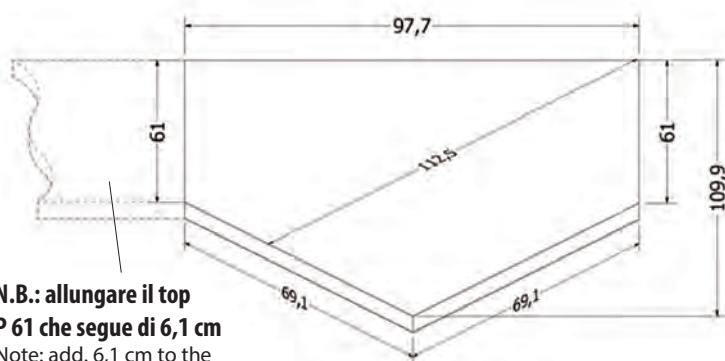

verso dx
RH version

N.B.: allungare il top P 61 che segue di 6,1 cm
Note: add. 6,1 cm to the worktop next to the inclined base unit

COD.	NECK MELAMINICO KT5	NECK LACCATO KT6	NECK WOOD KT4			
G4910051/2	153	185	261			
opz.002	+40	+40	+40			
97,7x109,9 lamin.bordo ABS1						
H 4 T9062621/2						
97,7x109,9 laminato Fenix NTM						
H 2 TFEN2681/2	VEDI	VEDI	VEDI			
H 4 TFEN4681/2	LISTINO	LISTINO	LISTINO			
	TOP	TOP	TOP			
97,7x109,9 quarzo pasta piena profilo P						
H 2 TQRP2681/2						
fascia "A"	VEDI	VEDI	VEDI			
fascia "B"	LISTINO	LISTINO	LISTINO			
fascia "C"	TOP	TOP	TOP			
H 3 TQRP3681/2						
fascia "A"	VEDI	VEDI	VEDI			
fascia "B"	LISTINO	LISTINO	LISTINO			
fascia "C"	TOP	TOP	TOP			
97,7x109,9 quarzo bordo quarzo profilo P						
H 4 TQRP4681/2						
fascia "A"	VEDI	VEDI	VEDI			
fascia "B"	LISTINO	LISTINO	LISTINO			
fascia "C"	TOP	TOP	TOP			

BASE INCLINATA SNACK "TIPO 2"

INCLINED SNACK BASE UNIT "TYPE 2"

LE BASI NON SONO COMPRENSIVE DI TOP
THE BASE UNITS DO NOT INCLUDE THE TOPS

kit base snack "tipo 2" per vano L 60
inclined snack base unit "type 2" kit W 60

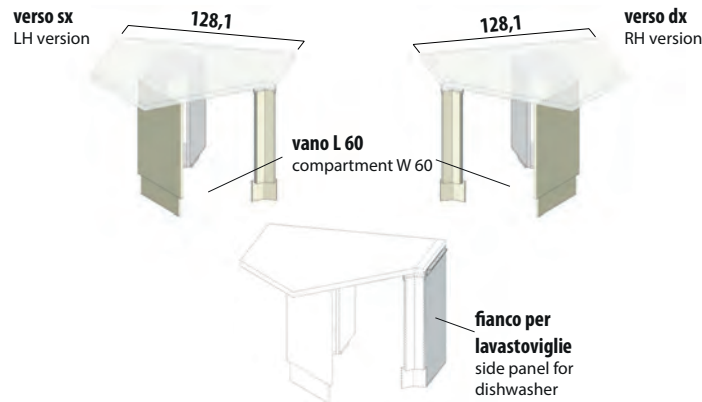

kit "tipo 2"
"type 2" kit

mag. inserimento fianco per lavastoviglie dx o sx
surcharge for dishwasher side panel placed on RH or LH side

top per base snack "tipo 2"
worktop for inclined snack base unit "type 2"

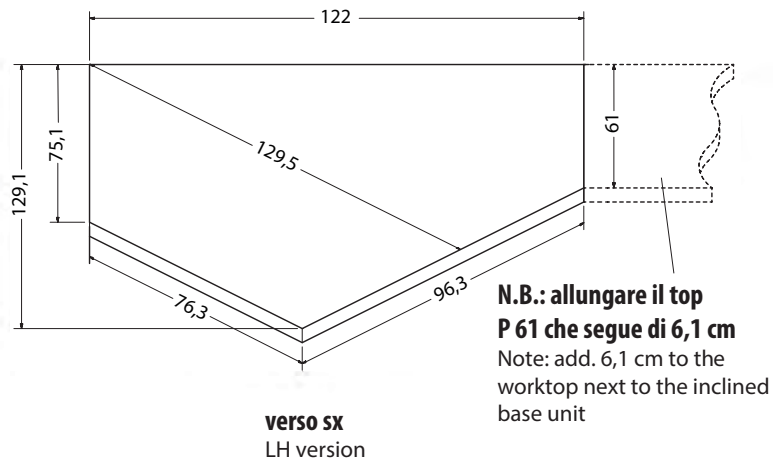

N.B.: allungare il top P 61 che segue di 6,1 cm
Note: add. 6,1 cm to the worktop next to the inclined base unit

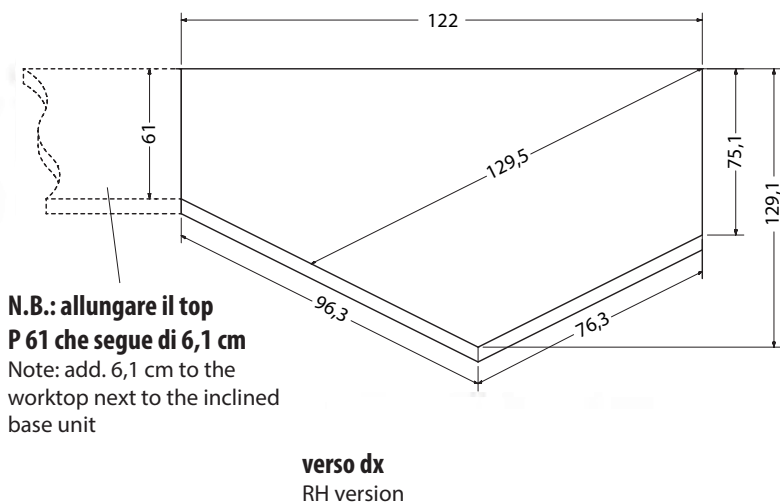

N.B.: allungare il top P 61 che segue di 6,1 cm
Note: add. 6,1 cm to the worktop next to the inclined base unit

COD.	NECK MELAMINICO KT5	NECK LACCATO KT6	NECK WOOD KT4			
G4910071/2	252	302	434			
opz.002	+40	+40	+40			
122x129,1 lamin.bordo ABS1						
H 4 T9062631/2						
122x129,1 laminato Fenix NTM						
H 2 TFEN2691/2	VEDI	VEDI	VEDI			
H 4 TFEN4691/2	LISTINO	LISTINO	LISTINO			
	TOP	TOP	TOP			
122x129,1 quarzo pasta piena profilo P						
H 2 TQRP2691/2						
fascia "A"	VEDI	VEDI	VEDI			
fascia "B"	LISTINO	LISTINO	LISTINO			
fascia "C"	TOP	TOP	TOP			
H 3 TQRP3691/2						
fascia "A"	VEDI	VEDI	VEDI			
fascia "B"	LISTINO	LISTINO	LISTINO			
fascia "C"	TOP	TOP	TOP			
Foro rettangolare	T9FRE					
122x129,1 quarzo bordo quarzo profilo P						
H 4 TQRP4691/2						
fascia "A"	VEDI	VEDI	VEDI			
fascia "B"	LISTINO	LISTINO	LISTINO			
fascia "C"	TOP	TOP	TOP			
Foro rettangolare	T9FRE					



GOLE PER COLONNE

COLUMNS FINGER RAILS

NELLE COLONNE PER L'APERTURA DELLE ANTE E' OBBLIGATORIO L'INSERIMENTO DELLE GOLE VERTICALI
VERTICAL FINGER RAILS MUST BE FITTED TO COLUMNS WITH OPENING DOORS

COD.

MELAMI-
NICO
KT5

LACCATO
KT6

WOOD
KT0

mezza gola elle verticale tipo "C"
 elle half finger rail type "C"

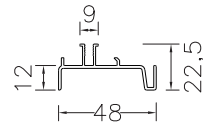

Sezione gola tipo "C"
 Type "C" finger rail section

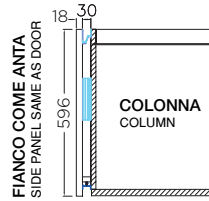

***gola con fianco come anta montato**
 *finger rail mounted on side panel same as door

gola
 finger rail

H 96	G950310	63	63	63
H 132	G950330	83	83	83
H 204	G950350	123	123	123
H 228	G950370	136	136	136
H 96	G950319	111	136	186
H 132	G950339	140	174	246
H 204	G950359	200	252	375
H 228	G950379	219	278	410

gola elle verticale intermedia tipo "D"
 elle vertical intermediate finger rail type "D"

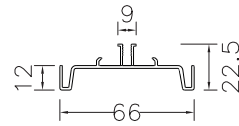

Sezione gola tipo "D"
 Type "D" finger rail section

gola
 finger rail

H 96	G950410	63	63	63
H 132	G950430	83	83	83
H 204	G950450	123	123	123
H 228	G950470	136	136	136

gola elle verticale laterale tipo "E"
 elle vertical lateral finger rail type "E"

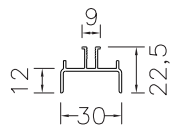

Sezione gola tipo "E"
 Type "E" finger rail section

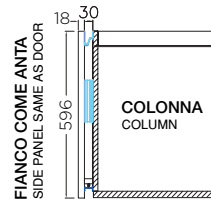

***gola con fianco come anta montato**
 *finger rail mounted on side panel same as door





gola
 finger rail

H 96	G950510	63	63	63
H 132	G950530	83	83	83
H 204	G950550	123	123	123
H 228	G950570	136	136	136
H 96	G950519	111	136	186
H 132	G950539	140	174	246
H 204	G950559	200	252	375
H 228	G950579	219	278	410

COLONNE H 109

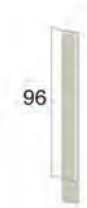
COLUMNS H 109

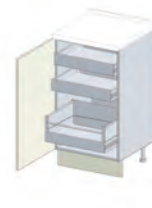
P 59,5





Le colonne non sono comprensive di top - N.B.: cerniere ammortizzate di serie The columns do not include the tops - Note: standard blumotion hinges		COD.	NECK MELAMI- NICO KT5	NECK LACCATO KT6	NECK WOOD KT4			
 <p>fascia tamponamento da 5 a 15 filler panel size from 5 to 15</p>								
	<p>in nobilitato melamine coated</p>	G6000010	50	50	50			
	<p>come anta con supporto same as door with support</p>	G6000140	72	89	108			
 <p>1 anta 1 door</p>								
	L 30	G6040301/2	159	173	193			
	L 40	G6040401/2	173	191	224			
	L 45	G6040451/2	179	196	233			
 <p>1 anta vetro 1 glass door</p>								
	<p>telaio alluminio L 45 aluminium frame</p>	G6047451/2	298	298	298			
<p>telaio melaminico L 45 melamine frame</p>	G6046451/2	323	—	—				
 <p>*1 anta (cerniere 180°) 2 cassetti interni 1 cestone interno *1 door (180° hinges) 2 internal drawers 1 internal deep drawer</p>								
	L 45	G6041461/2	360	377	431			
L 60	G6041611/2	386	411	481				
 <p>jolly colonna L da 10 a 30 jolly column size from 10 to 30</p>								
	<p>colore come struttura same colour as carcass</p>	E6000900	190	190	190			
	<p>melaminico come anta melamine same as door</p>	E6000930	228	—	—			
<p>impiallacciato come anta (folding) veneered same as door (folding)</p>	E6005052	—	—	691				
<p>NELLE COLONNE PER L'APERTURA DELLE ANTE E' OBBLIGATORIO L'INSERIMENTO DELLE GOLE VERTICALI VERTICAL FINGER RAILS MUST BE FITTED TO COLUMNS WITH OPENING DOORS</p>								
<p>*LE COLONNE CON CASSETTI E GESTONI INTERNI VANNO SEMPRE POSIZIONATE A 5 CM DALLA PARETE LATERALE *COLUMNS WITH INTERNAL DRAWERS AND DEEP DRAWERS SHOULD ALWAYS BE PLACED 5 CM FROM THE SIDE WALL</p>								

NECK
COLONNE
COLUMNS

COLONNE H 145

COLUMNS H 145



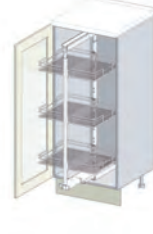

P 59,5

Le colonne non sono comprensive di top - N.B.: cerniere ammortizzate di serie The columns units do not include the tops - Note: standard blumotion hinges		COD.	NECK MELAMI- NICO KT5	NECK LACCATO KT6	NECK WOOD KT4			
 <p>fascia tamponamento da 5 a 15 filler panel size from 5 to 15</p>								
	<p>in nobilitato melamine coated</p>	G6000020	51	51	51			
	<p>come anta con supporto same as door with support</p>	G6000150	77	97	127			
 <p>1 anta 1 door</p>								
	L 30	G6050301/2	186	205	239			
	L 45	G6050451/2	210	237	291			
	L 60	G6050601/2	234	269	344			
 <p>1 anta vetro 1 glass door</p>								
	telaio alluminio L 45 aluminium frame	G6182451/2	328	328	328			
	L 60	G6182601/2	373	373	373			
	telaio melaminico L 45 melamine frame	G6180451/2	373	—	—			
	L 60	G6180601/2	394	—	—			
 <p>1 anta integrata al gruppo cestelli estraibili in filo orion grau chiusura soft 1 door incorporated into the orion grau wire pull-out basket units soft-closing system</p>								
	L 30	G6150300	429	447	586			
 <p>1 anta gruppo cestelli estraibili in filo orion grau chiusura soft 1 door orion grau wire pull-out basket units soft-closing system</p>								
	L 45	G6150451/2	458	483	609			
	L 60	G6150601/2	497	530	713			
 <p>1 anta vetro gruppo cestelli estraibili in filo orion grau chiusura soft 1 glass door orion grau wire pull-out basket units soft-closing system</p>								
	telaio alluminio L 45 aluminium frame	G6152461/2	591	591	591			
	L 60	G6152611/2	658	658	658			
	telaio melaminico L 45 melamine frame	G6152451/2	637	—	—			
	L 60	G6152601/2	676	—	—			

COLONNE H 145

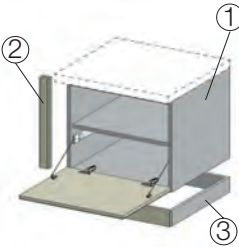
COLUMNS H 145

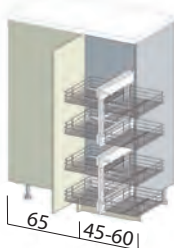





P 59,5

Le colonne non sono comprensive di top - N.B.: cerniere ammortizzate di serie The columns units do not include the tops - Note: standard blumotion hinges		COD.	NECK MELAMI- NICO KT5	NECK LACCATO KT6	NECK WOOD KT4			
 <p>mobile H 57 L 65 apertura a vasistas push-pull con fascia di tamponamento laterale e inferiore in appoggio su base angolo unit H 57 W 65 flap door push-pull opening with lateral and lower filler panel resting on corser base unit</p> <p>verso SX LH version</p>								
	<p>1. elemento H 48 L 60 wall unit H 48 W 60</p>	E2520600	256	269	308			
	<p>2. fascia laterale H 48 L 5 lateral filler panel H 48 W 5</p>	E278000A	51	57	64			
	<p>3. fascia inferiore H 9 L 65 lower filler panel H 9 W 65</p>	E2882000	59	64	77			
 <p>Esempio di mobile in appoggio su base angolo con colonna H 132 affiancata Example of unit resting on corser base unit with side by side column H 132</p> <p>verso SX LH version</p>								
 <p>angolo 2 ripiani con tirante 1 anta (cerniere a pilastro) pannello come anta corner unit 2 shelves with tie beam 1 door (hinges pillar) panel as door</p> <p>65 45-60</p>	L 110	G6336101/2	378	437	595			
	L 125	G6336251/2	398	457	637			
 <p>angolo 8 cestelli orion grau estraibili indipendenti all'anta 1 anta pannello come anta corner unit 8 pull-out orion grau basket units independent from door 1 door panel as door</p> <p>65 45-60</p>	L 110	G6338101/2	1.258	1.317	1.505			
	L 125	G6338251/2	1.409	1.468	1.683			
 <p>jolly colonna L da 10 a 30 jolly column size from 10 to 30</p>								
	<p>colore come struttura same colour as carcass</p>	E6001000	218	218	218			
	<p>melaminico come anta melamine same as door</p>	E6001030	284	—	—			
<p>impiallacciato come anta (folding) veneered same as door (folding)</p>	E6005102	—	—	881				

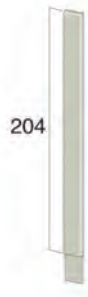
COLONNE H 217

COLUMNS H 217







P 33 - 59,5

N.B.: cerniere ammortizzate di serie Note: standard blumotion hinges		COD.	NECK	NECK	NECK				
			MELAMI- NICO KT5	LACCATO KT6	WOOD KT4				
 <p>fascia tamponamento da 5 a 15 filler panel size from 5 to 15</p> <p>204</p>									
		in nobilitato melamine coated	G6000050	58	58	58			
		come anta con supporto same as door with support	G6000200	87	111	159			
 <p>2 ante anta superiore H 72 anta inferiore H 132 2 doors upper door H 72 lower door H 132</p>									
		L 45 P 33	G601345A1/2	249	292	399			
		L 60 P 33	G601360A1/2	285	342	484			
 <p>2 ante anta superiore H 72 anta inferiore H 132 2 doors upper door H 72 lower door H 132</p>									
		L 30 P 59,5	G606030A1/2	266	296	350			
		L 45 P 59,5	G606345A1/2	300	343	429			
		L 60 P 59,5	G606360A1/2	344	401	524			
		L 75 P 59,5	G606375A1/2	517	582	643			
 <p>2 ante anta superiore H 132 anta inferiore H 72 2 doors upper door H 132 lower door H 72</p>									
		L 45 P 33	G601045A1/2	249	292	399			
		L 60 P 33	G601060A1/2	285	342	484			
 <p>2 ante anta vetro H 132 anta chiusa H 72 2 doors glass door H 132 full door H 72</p>									
		telaio alluminio L 45 P 33 aluminium frame	G6205451/2	356	371	429			
		L 60 P 33	G6205601/2	413	431	488			
		telaio melaminico L 45 P 33 melamine frame	G6202451/2	402	—	—			
		L 60 P 33	G6202601/2	426	—	—			
 <p>2 ante vetro anta superiore H 132 anta inferiore H 72 2 glass doors upper door H 132 lower door H 72</p>									
		telaio alluminio L 45 P 33 aluminium frame	G6203461/2	464	464	464			
		L 60 P 33	G6203611/2	538	538	538			
		telaio melaminico L 45 P 33 melamine frame	G6200461/2	560	—	—			
		L 60 P 33	G6200611/2	597	—	—			

COLONNE H 217

COLUMNS H 217





P 59,5

N.B.: cerniere ammortizzate di serie Note: standard blumotion hinges		COD.	NECK	NECK	NECK				
			MELAMI- NICO KT5	LACCATO KT6	WOOD KT4				
 <p>2 ante anta superiore H 132 anta inferiore H 72 2 doors upper door H 132 lower door H 72</p>	L 45	G606045A1/2	300	343	429				
	L 60	G606060A1/2	344	401	524				
	L 75	G606075A1/2	517	582	645				
 <p>2 ante vetro anta superiore H 132 anta inferiore H 72 2 glass doors upper door H 132 lower door H 72</p>									
		telaio alluminio L 45 aluminium frame	G6203451/2	509	509	509			
		L 60	G6203601/2	589	589	589			
		telaio melaminico L 45 melamine frame	G6200451/2	607	—	—			
	L 60	G6200601/2	647	—	—				
 <p>2 ante anta vetro H 132 anta chiusa H 72 2 doors glass door H 132 full door H 72</p>									
		telaio alluminio L 45 aluminium frame	G6204451/2	402	416	457			
		L 60	G6204601/2	464	482	524			
		telaio melaminico L 45 melamine frame	G6201451/2	447	—	—			
	L 60	G6201601/2	477	—	—				
 <p>portascope 2 ante anta superiore H 72 anta inferiore H 132 broom cabinet 2 doors upper door H 72 lower door H 132</p>	L 30	G610030A1/2	264	294	349				
	L 45	G610045A1/2	291	334	421				
 <p>portascope con ripiani 2 ante anta superiore H 72 anta inferiore H 132 broom cabinet with shelves 2 doors upper door H 72 lower door H 132</p>	L 60	G610060A1/2	355	412	545				
 <p>1 anta H 204 1 door H 204</p>	L 45	G6061451/2	299	341	423				
	L 60	G6061601/2	357	412	539				

COLONNE H 217

COLUMNS H 217



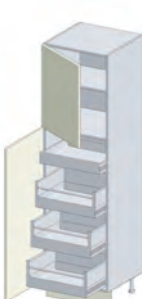

P 59,5

N.B.: cerniere ammortizzate di serie Note: standard blumotion hinges		COD.	NECK	NECK	NECK			
			MELAMI- NICO KT5	LACCATO KT6	WOOD KT4			
 <p>portascopie 1 anta H 204 broom cabinet 1 door H 204</p>	L 45	G6100461/2	279	321	413			
	 <p>portascopie con ripiani 1 anta H 204 broom cabinet with shelves 1 door H 204</p>	L 60	G6100611/2	365	420	558		
 <p>anta H 204 integrata al gruppo cestelli estraibili in filo orion grau chiusura soft door H 204 incorporated into the orion grau wire pull-out basket unit soft-closing system</p>		L 30	G6163300	567	594	779		
	L 45	G6163450	624	663	882			
 <p>1 anta superiore H 72 1 anta H 132 integrata al gruppo cestelli estraibili in filo orion grau chiusura soft 1 upper door H 72 1 door H 132 incorporated into the orion grau wire pull-out basket units soft-closing system</p>	L 30	G616030A1/2	504	532	695			
	 <p>1 anta superiore H 72 1 anta inferiore H 132 gruppo cestelli estraibili in filo orion grau chiusura soft 1 upper door H 72 1 lower door H 132 orion grau wire pull-out basket units soft-closing system</p>	L 45	G616045A1/2	545	585	746		
L 60		G616060A1/2	596	647	877			
 <p>*1 anta superiore H 72 (cerniere 100°) 1 anta inferiore H 132 (cerniere 180°) 1 cassetto interno 3 cestoni interni *1 upper door H 72 (100° hinges) 1 lower door H 132 (180° hinges) 1 internal drawer 3 internal deep drawers</p>	L 45	G608048A1/2	537	576	716			
	L 60	G608063A1/2	586	637	813			

COLONNE H 217

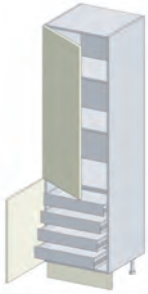
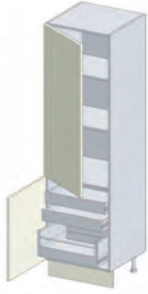
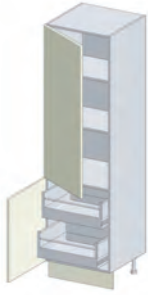
COLUMNS H 217



P 59,5

N.B.: cerniere ammortizzate di serie Note: standard blumotion hinges		COD.	NECK	NECK	NECK			
			MELAMI- NICO KT5	LACCATO KT6	WOOD KT4			
 <p> *1 anta superiore H 132 (cerniere 100°) 1 anta inferiore H 72 (cerniere 180°) 4 cassetti interni *1 upper door H 132 (100° hinges) 1 lower door H 72 (180° hinges) 4 internal drawers </p>	L 45	G606545A1/2	500	539	662			
	L 60	G606560A1/2	549	600	762			
 <p> *1 anta superiore H 132 (cerniere 100°) 1 anta inferiore H 72 (cerniere 180°) 2 cassetti interni 1 cestone interno *1 upper door H 132 (100° hinges) 1 lower door H 72 (180° hinges) 2 internal drawers 1 internal deep drawer </p>	L 45	G606546A1/2	458	497	620			
	L 60	G606561A1/2	501	552	711			
 <p> *1 anta superiore H 132 (cerniere 100°) 1 anta inferiore H 72 (cerniere 180°) 2 cestoni interni *1 upper door H 132 (100° hinges) 1 lower door H 72 (180° hinges) 2 internal deep drawers </p>	L 45	G606645A1/2	417	456	578			
	L 60	G606660A1/2	458	509	665			
 <p> *1 anta vetro superiore H 132 1 anta inferiore H 72 4 cassetti interni *1 upper glass door H 132 1 lower door H 72 4 internal drawers </p>	telaio alluminio L 45 aluminium frame	G6287451/2	626	640	705			
	L 60	G6287601/2	701	719	792			
	telaio melaminico L 45 melamine frame	G6284451/2	672	—	—			
	L 60	G6284601/2	714	—	—			
 <p> *1 anta vetro superiore H 132 1 anta inferiore H 72 2 cassetti interni 1 cestone interno *1 upper glass door H 132 1 lower door H 72 2 internal drawers 1 internal deep drawer </p>	telaio alluminio L 45 aluminium frame	G6287461/2	584	599	664			
	L 60	G6287611/2	657	676	746			
	telaio melaminico L 45 melamine frame	G6284461/2	630	—	—			
	L 60	G6284611/2	673	—	—			
 <p> *1 anta vetro superiore H 132 1 anta inferiore H 72 2 cestoni interni *1 upper glass door H 132 1 lower door H 72 2 internal deep drawers </p>	telaio alluminio L 45 aluminium frame	G6288451/2	543	557	622			
	L 60	G6288601/2	615	634	701			
	telaio melaminico L 45 melamine frame	G6285451/2	589	—	—			
	L 60	G6285601/2	635	—	—			

COLONNE H 217

COLUMNS H 217

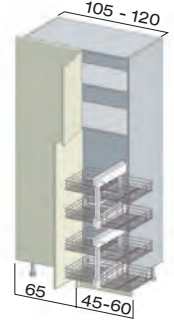





P 59,5

N.B.: cerniere ammortizzate di serie Note: standard blumotion hinges		COD.	NECK MELAMI- NICO KT5	NECK LACCATO KT6	NECK WOOD KT4					
 <p>angolo 4 ripiani con tirante 1 anta superiore H 72 1 anta inferiore H 132 (cerniere a pilastro) pannello come anta corner unit 4 shelves with tie beam 1 upper door H 72 1 lower door H 132 (pillar hinges) panel as door</p>	L 110	G6306101/2	528	620	865					
	L 125	G6306251/2	548	635	929					
 <p>angolo 8 cestelli orion grau estraibili 1 anta superiore H 72 1 anta inferiore H 132 pannello come anta corner unit 8 pull-out orion grau basket units 1 upper door H 72 1 lower door H 132 panel as door</p>	L 110	G6308101/2	1.408	1.500	1.775					
	L 125	G6308251/2	1.559	1.646	1.975					
 <p>jolly colonna L da 15 a 30 jolly column size from 15 to 30</p>										
			colore come struttura same colour as carcass	E6002000	285	285	285			
			melaminico come anta melamine same as door	E6002030	386	—	—			
		impiallacciato come anta (folding) veneered same as door (folding)	E6005202	—	—	1.260				
<p>*LE COLONNE CON CASSETTI E CESTONI INTERNI VANNO SEMPRE POSIZIONATE A 5 CM DALLA PARETE LATERALE *COLUMNS WITH INTERNAL DRAWERS AND DEEP DRAWERS SHOULD ALWAYS BE PLACED 5 CM FROM THE SIDE WALL</p>										
<p>NELLE COLONNE PER L'APERTURA DELLE ANTE E' OBBLIGATORIO L'INSERIMENTO DELLE GOLE VERTICALI VERTICAL FINGER RAILS MUST BE FITTED TO COLUMNS WITH OPENING DOORS</p>										

COLONNE H 241

COLUMNS H 241







P 33 - 59,5

N.B.: cerniere ammortizzate di serie Note: standard blumotion hinges		COD.	NECK	NECK	NECK			
			MELAMI- NICO KT5	LACCATO KT6	WOOD KT4			
 <p>fascia tamponamento da 5 a 15 filler panel size from 5 to 15</p> <p>228</p>	in nobilitato melamine coated	G6000100	58	58	58			
	come anta con supporto same as door with support	G6000250	88	114	167			
 <p>2 ante anta superiore H 96 anta inferiore H 132 2 doors upper door H 96 lower door H 132</p>	L 45 P 33	G602345A1/2	306	351	443			
	L 60 P 33	G602360A1/2	351	414	541			
 <p>2 ante anta superiore H 96 anta inferiore H 132 2 doors upper door H 96 lower door H 132</p>	L 30 P 59,5	G607030A1/2	294	327	396			
	L 45 P 59,5	G607345A1/2	330	376	474			
	L 60 P 59,5	G607360A1/2	384	447	583			
 <p>2 ante anta superiore H 156 anta inferiore H 72 2 doors upper door H 156 lower door H 72</p>	L 45 P 33	G602045A1/2	306	353	443			
	L 60 P 33	G602060A1/2	346	410	537			
 <p>2 ante anta vetro H 156 anta chiusa H 72 2 doors glass door H 156 full door H 72</p>	telaio alluminio L 45 P 33 aluminium frame	G6215451/2	433	448	480			
	telaio melaminico L 45 P 33 melamine frame	G6212451/2	468	—	—			
 <p>2 ante vetro anta superiore H 156 anta inferiore H 72 2 glass doors upper door H 156 lower door H 72</p>	telaio alluminio L 45 P 33 aluminium frame	G6213461/2	543	543	543			
	telaio melaminico L 45 P 33 melamine frame	G6210461/2	627	—	—			

COLONNE H 241

COLUMNS H 241





P 59,5

N.B.: cassetti e cestoni ad estrazione totale con blumotion Note: fully extending drawers and deep drawers with blumotion system		COD.	NECK	NECK	NECK			
			MELAMI- NICO KT5	LACCATO KT6	WOOD KT4			
 <p>2 ante anta superiore H 156 anta inferiore H 72 2 doors upper door H 156 lower door H 72</p>	L 45	G607045A1/2	330	378	474			
	L 60	G607060A1/2	380	443	579			
 <p>2 ante anta vetro H 156 anta chiusa H 72 2 doors glass door H 156 full door H 72</p>								
		telaio alluminio L 45 aluminium frame G6214451/2	456	470	509			
		telaio melaminico L 45 melamine frame G6211451/2	491	—	—			
 <p>2 ante vetro anta superiore H 156 anta inferiore H 72 2 glass doors upper door H 156 lower door H 72</p>								
		telaio alluminio L 45 aluminium frame G6213451/2	562	562	562			
		telaio melaminico L 45 melamine frame G6210451/2	650	—	—			
 <p>portascope 1 anta superiore H 96 1 anta inferiore H 132 broom cabinet 1 upper door H 96 1 lower door H 132</p>	L 30	G611030A1/2	291	324	392			
	L 45	G611045A1/2	322	367	466			
 <p>portascope con ripiani 1 anta superiore H 96 1 anta inferiore H 132 broom cabinet with shelves 1 upper door H 96 1 lower door H 132</p>								
	L 60	G611060A1/2	380	443	592			
 <p>1 anta superiore H 96 1 anta H 132 integrata al gruppo cestelli estraibili in filo orion grau chiusura soft 1 upper door H 96 1 door H 132 incorporated into the orion grau wire pull-out basket units soft-closing system</p>								
	L 30	G617030A1/2	528	559	728			

COLONNE H 241

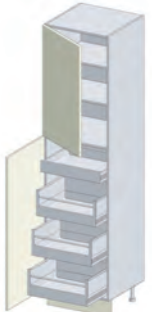
COLUMNS H 241



P 59,5

N.B.: cassetti e cestoni ad estrazione totale con blumotion Note: fully extending drawers and deep drawers with blumotion system		COD.	NECK MELAMI- NICO KT5	NECK LACCATO KT6	NECK WOOD KT4			
 <p> 1 anta superiore H 96 1 anta inferiore H 132 gruppo cestelli estraibili in filo orion grau chiusura soft 1 upper door H 96 1 lower door H 132 orion grau wire pull-out basket units soft-closing system </p>	L 45	G617045A1/2	574	616	789			
	L 60	G617060A1/2	632	689	933			
 <p> *1 anta superiore H 96 (cerniere 100°) 1 anta inferiore H 132 (cerniere 180°) 1 cassetto interno 3 cestoni interni *1 upper door H 96 (100° hinges) 1 lower door H 132 (180° hinges) 1 internal drawer 3 internal deep drawers </p>	L 45	G608248A1/2	564	606	758			
	L 60	G608263A1/2	621	677	868			
 <p> *1 anta superiore H 156 (cerniere 100°) 1 anta inferiore H 72 (cerniere 180°) 4 cassetti interni *1 upper door H 156 (100° hinges) 1 lower door H 72 (180° hinges) 4 internal drawers </p>	L 45	G607545A1/2	527	570	704			
	L 60	G607560A1/2	575	632	808			
 <p> *1 anta superiore H 156 (cerniere 100°) 1 anta inferiore H 72 (cerniere 180°) 2 cassetti interni 1 cestone interno *1 upper door H 156 (100° hinges) 1 lower door H 72 (180° hinges) 2 internal drawers 1 internal deep drawer </p>	L 45	G607546A1/2	486	529	662			
	L 60	G607561A1/2	532	589	762			
 <p> *1 anta superiore H 156 (cerniere 100°) 1 anta inferiore H 72 (cerniere 180°) 2 cestoni interni *1 upper door H 156 (100° hinges) 1 lower door H 72 (180° hinges) 2 internal deep drawers </p>	L 45	G607645A1/2	444	488	620			
	L 60	G607660A1/2	490	546	716			
<p> *LE COLONNE CON CASSETTI E GESTONI INTERNI VANNO SEMPRE POSIZIONATE A 5 CM DALLA PARETE LATERALE *COLUMNS WITH INTERNAL DRAWERS AND DEEP DRAWERS SHOULD ALWAYS BE PLACED 5 CM FROM THE SIDE WALL </p>								

COLONNE H 241

COLUMNS H 241



P 59,5

N.B.: cassetti e cestoni ad estrazione totale con blumotion Note: fully extending drawers and deep drawers with blumotion system		COD.	NECK MELAMI- NICO KT5	NECK LACCATO KT6	NECK WOOD KT4			
 <p> *1 anta vetro superiore H 156 1 anta inferiore H 72 4 cassetti interni *1 upper glass door H 156 1 lower door H 72 4 internal drawers </p>	telaio alluminio L 45 aluminium frame	G6297451/2	680	694	757			
	telaio melaminico L 45 melamine frame	G6294451/2	715	—	—			
 <p> *1 anta vetro superiore H 156 1 anta inferiore H 72 2 cassetti interni 1 cestone interno *1 upper glass door H 156 1 lower door H 72 2 internal drawers 1 internal deep drawer </p>	telaio alluminio L 45 aluminium frame	G6297461/2	639	653	716			
	telaio melaminico L 45 melamine frame	G6294461/2	673	—	—			
 <p> *1 anta vetro superiore H 156 1 anta inferiore H 72 2 cestoni interni *1 upper glass door H 156 1 lower door H 72 2 internal deep drawers </p>	telaio alluminio L 45 aluminium frame	G6298451/2	598	612	674			
	telaio melaminico L 45 melamine frame	G6295451/2	632	—	—			
<p style="color: red;"> NELLE COLONNE PER L'APERTURA DELLE ANTE E' OBBLIGATORIO L'INSERIMENTO DELLE GOLE VERTICALI VERTICAL FINGER RAILS MUST BE FITTED TO COLUMNS WITH OPENING DOORS </p>								

COLONNE ANGOLO H 241

P 59,5







CORNER COLUMNS H 241

N.B.: cerniere ammortizzate di serie Note: standard blumotion hinges		COD.	NECK MELAMI- NICO KT5	NECK LACCATO KT6	NECK WOOD KT4				
 <p>angolo 5 ripiani con tirante 1 anta superiore H 96 1 anta inferiore H 132 (cerniere a pilastro) pannello come anta corner unit 5 shelves with tie beam 1 upper door H 96 1 lower door H 132 (pillar hinges) panel as door</p>	L 110	G6316101/2	578	678	950				
	L 125	G6316251/2	598	698	1.030				
 <p>angolo 8 cestelli orion grau estraibili indipendenti all'anta 1 anta superiore H 96 1 anta inferiore H 132 pannello come anta corner unit 8 pull-out orion grau basket units independent from door 1 upper door H 96 1 lower door H 132 panel as door</p>	L 110	G6318101/2	1.458	1.558	1.860				
	L 125	G6318251/2	1.609	1.709	2.076				
 <p>jolly colonna L da 15 a 30 jolly column size from 15 to 30</p>									
		colore come struttura same colour as carcass	E6003000	307	307	307			
		melaminico come anta melamine same as door	E6003030	414	—	—			
	impiallacciato come anta (folding) veneered same as door (folding)	E6005252	—	—	1.406				
<p>NELLE COLONNE PER L'APERTURA DELLE ANTE E' OBBLIGATORIO L'INSERIMENTO DELLE GOLE VERTICALI VERTICAL FINGER RAILS MUST BE FITTED TO COLUMNS WITH OPENING DOORS</p>									

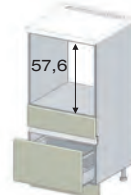
COLONNE PER FORNO H 109 - 128

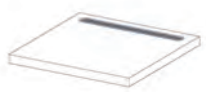
P 59,5

OVEN COLUMNS H 109 - 128

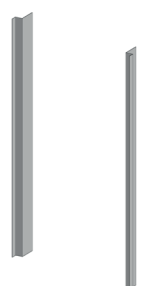

Le colonne non sono comprensive di top - N.B.: cassetti e cestoni ad estrazione totale con blumotion The columns do not include the tops - Note: fully extending drawers and deep drawers with blumotion system		COD.	NECK MELAMI- NICO KT5	NECK LACCATO KT6	NECK WOOD KT4			
 <p>colonna H 109 per forno 1 cestone chiuso H 35,7 oven column H 109 1 full deep drawer H 35,7</p>								
	L 60	G6501600	228	238	269			
 <p>colonna H 128 per forno con gola orizzontale 1 cassetto H 16,9 1 cestone H 34,2 oven column H 128 with horizontal finger rail 1 drawer H 16,9 1 deep drawer H 34,2</p> <p>N.B.: colonna da utilizzare con basi cestoni Note: column to use with deep drawer base units</p> 								
	L 60	G6510600	322	341	377			
 <p>top H 1,8 come anta P 59,6 per colonne worktop H 1,8 same as door D 59,6 for columns</p>								
		melaminico al ml melamine per lm TLE186	77	—	—			
		laccato al ml lacquered per lm TLC196	—	96	—			
		impiallacciato al ml veneered per lm TLH186W	—	—	136			
		mag.griglia di areazione cad. surcharge for ventilation grille each T9FGA	30	30	30			
 <p>profilo in acciaio a "L" per rifinire il ripiano del forno e microonde L-shaped steel finishing profile for shelf of oven and microwave</p> 								
	L 60							
	inox stainless steel	08660100	9	9	9			
	nero black	08660101	9	9	9			
	bianco white	08660102	9	9	9			
L 90								
inox stainless steel	08660105	12	12	12				
 <p>kit protezione fianchi per forno protection kit sides for oven</p> 								
	coppia couple	08630095	16	16	16			

COLONNE PER FORNO H 145

P 59,5

OVEN COLUMNS H 145

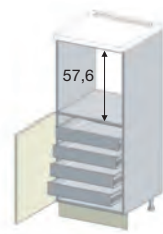
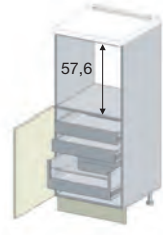
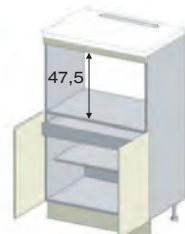
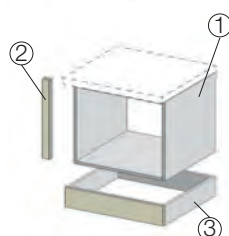

Le colonne non sono comprensive di top - N.B.: cerniere ammortizzate di serie
The columns do not include the tops - Note: standard blumotion hinges

	COD.	NECK MELAMI- NICO KT5	NECK LACCATO KT6	NECK WOOD KT4				
 <p>colonna H 145 per forno 1 anta H 72 apertura push-pull oven column H 145 1 door H 72 push-pull opening</p>	L 60	G6520601/2	227	247	285			
	L 75	G6520751/2	268	290	332			
 <p>colonna H 145 per forno 1 anta H 72 apertura push-pull (cerniere 180°) 4 cassetti interni posizionare a 5 cm dalla parete laterale oven column H 145 1 door H 72 push-pull opening (180°hinges) 4 internal drawers place at 5 cm from the side wall</p>	L 60	G6521611/2	447	465	543			
	L 60	G6521621/2	404	422	497			
 <p>colonna H 145 per forno 1 anta H 72 apertura push-pull (cerniere 180°) 2 cassetti interni 1 cestone interno posizionare a 5 cm dalla parete laterale oven column H 145 1 door H 72 push-pull opening (180°hinges) 2 internal drawers 1 internal deep drawer place at 5 cm from the side wall</p>	L 60	G6521631/2	364	383	455			
	L 60	G6521950	432	469	576			
 <p>colonna H 145 per forno per maxiforno H 48 1 cassetto interno 2 ante H 72 apertura push-pull (cerniere 180°) posizionare a 5 cm dalla parete laterale oven column H 145 for maxi-oven H 48 1 internal drawer 2 doors H 72 push-pull opening (180°hinges) place at 5 cm from the side wall</p>	L 90	E2521600	121	121	121			
		E278000B	51	57	64			
 <p>mobile H 57 L 65 per micro con fascia di tamponamento laterale e inferiore in appoggio su base angolo unit H 57 W 65 flap door push-pull opening with lateral and lower filler panel resting on corser base unit</p> <p>1. elemento per micro H 47,5 L 60 micro unit H 47,5 W 60 2. fascia laterale H 47,5 L 5 lateral filler panel H 47,5 W 5 3. fascia inferiore H 9,5 L 65 lower filler panel H 9,5 W 65</p>		E2882100	59	64	77			
 <p>Esempio di mobile per micro in appoggio su base angolo con colonna H 132 affiancata Example of micro unit resting on corser base unit with side by side column H 132</p>								

COLONNE PER FORNO H 217

P 59,5

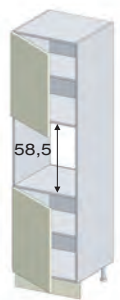
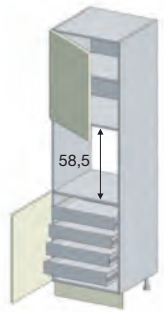
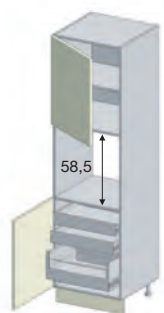
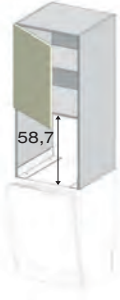



OVEN COLUMNS H 217

N.B.: cassetti e cestoni ad estrazione totale con blumotion Note: fully extending drawers and deep drawers with blumotion system		COD.	NECK MELAMI- NICO KT5	NECK LACCATO KT6	NECK WOOD KT4			
 <p>colonna per forno apertura push-pull 1 anta superiore H 72 1 anta inferiore H 72 oven column push-pull opening 1 upper door H 72 1 lower door H 72</p>	L 60	G653060A1/2	324	362	444			
	L 75	G653075A1/2	372	418	533			
 <p>colonna per forno apertura push-pull 1 anta superiore H 72 1 anta inferiore H 72 (cerniere 180°) 4 cassetti interni posizionare a 5 cm dalla parete laterale oven column push-pull opening 1 upper door H 72 1 lower door H 72 (180° hinges) 4 internal drawers place at 5 cm from the side wall</p>	L 60	G653161A1/2	564	601	725			
	L 60	G653162A1/2	521	558	679			
 <p>colonna per forno apertura push-pull 1 anta superiore H 72 1 anta inferiore H 72 (cerniere 180°) 2 cassetti interni 1 cestone interno posizionare a 5 cm dalla parete laterale oven column push-pull opening 1 upper door H 72 1 lower door H 72 (180° hinges) 2 internal drawers 1 internal deep drawer place at 5 cm from the side wall</p>	L 60	G653163A1/2	478	515	633			
	L 60	G6576601/2	268	287	320			
 <p>colonna forno sospesa H 132 per lavastoviglie 1 anta H 72 N.B.: inserire base lavastoviglie L 60 della versione Bridge hanging oven column H 132 for dishwasher 1 door H 72 Note: do insert dishwasher base unit for the Bridge version</p>	L 60	G6576601/2	268	287	320			
	L 60	G6576601/2	268	287	320			
 <p>fianco per colonna sospesa a fine composizione side panel for hanging column placed at the end of the composition</p>	H 217x59,6x1,8 zoccolo H 13 come anta same as door		T94380	104	—	281		
	H 217x59,7x1,9 zoccolo H 13 laccato come anta lacquered same as door		T94381	—	152	—		

COLONNE PER FORNO H 217

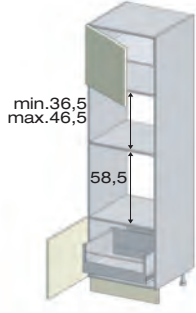
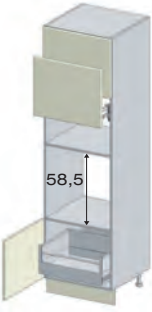
P 59,5

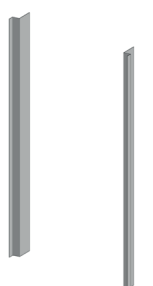

OVEN COLUMNS H 217

		COD.	NECK MELAMI- NICO KT5	NECK LACCATO KT6	NECK WOOD KT4			
<p>N.B.: cassetti e cestoni ad estrazione totale con blumotion Note: fully extending drawers and deep drawers with blumotion system</p>								
 <p>colonna per forno e micro apertura push-pull 1 anta superiore a misura 1 anta inferiore H 48 (cerniere 180°) 1 cestone interno vano micro da H 36,5 a 46,5 posizionare a 5 cm dalla parete laterale oven and microwave column push-pull opening 1 upper door made to size 1 lower door H 48 (180° hinges) 1 internal deep drawer microwave compartment H 36,5 to 46,5 place at 5 cm from the side wall</p>	L 60	G6552611/2	435	453	510			
	 <p>colonna per forno - 1 anta superiore H 48 1 anta H 48 sollevamento verticale 1 anta inferiore H 48 (cerniere 180°) 1 cestone interno posizionare a 5 cm dalla parete laterale N.B.: in base alla composizione è obbligatorio inserire nella colonna con anta sollevamento verticale, gola tipo "D" o "C" per permettere l'apertura della stessa oven column 1 upper door H 48 1 door H 48 vertical opening 1 lower door H 48 (180° hinges) - 1 internal deep drawer place at 5 cm from the side wall Note: based on the composition, a type "D" or "C" finger rail must be fitted to the column with vertical opening door to allow it to open</p>	L 60	G6554601/2	612	652	733		
 <p>colonna per forno e lavastoviglie Electrolux KESC 5300L - AEG FSE63307P 1 anta superiore H 48 1 anta lavastoviglie H 72 1 cassetto H 24 N.B.: in base alla composizione è obbligatorio inserire nella colonna con lavastoviglie, gola tipo "D" o "C" per permettere l'apertura della stessa column for oven and Electrolux KESC 5300L - AEG FSE63307P dishwasher 1 upper door H 48 1 dishwasher door H 72 1 drawer H 24 Note: based on the composition, a type "D" or "C" finger rail must be fitted to the column with dishwasher to allow it to open</p>		L 60	G6573601/2	382	421	516		
	 <p>profilo in acciaio a "L" per rifinire il ripiano del forno e microonde L-shaped steel finishing profile for shelf of oven and microwave</p> 	L 60						
inox stainless steel		08660100	9	9	9			
nero black		08660101	9	9	9			
bianco white		08660102	9	9	9			
 <p>kit protezione fianchi per forno protection kit sides for oven</p> 	coppia couple	08630095	16	16	16			

COLONNE PER FORNO H 241

P 59,5

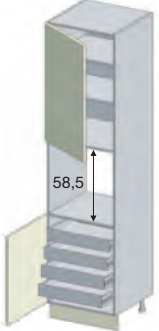
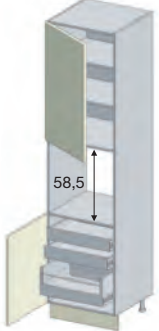
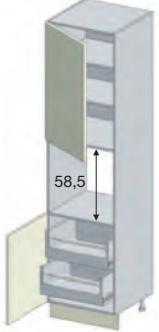
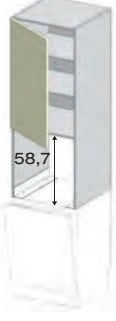



OVEN COLUMNS H 241

N.B.: cassetti e cestoni ad estrazione totale con blumotion Note: fully extending drawers and deep drawers with blumotion system		COD.	NECK MELAMI- NICO KT5	NECK LACCATO KT6	NECK WOOD KT4			
 <p>colonna per forno apertura push-pull 1 anta superiore H 96 1 anta inferiore H 72 oven column push-pull opening 1 upper door H 96 1 lower door H 72</p>	L 60	G654060A1/2	362	407	501			
	 <p>colonna per forno apertura push-pull 1 anta superiore H 96 1 anta inferiore H 72 (cerniere 180°) 4 cassetti interni posizionare a 5 cm dalla parete laterale oven column push-pull opening 1 upper door H 96 1 lower door H 72 (180° hinges) 4 internal drawers place at 5 cm from the side wall</p>	L 60	G654161A1/2	601	644	781		
 <p>colonna per forno apertura push-pull 1 anta superiore H 96 1 anta inferiore H 72 (cerniere 180°) 2 cassetti interni 1 cestone interno posizionare a 5 cm dalla parete laterale oven column push-pull opening 1 upper door H 96 1 lower door H 72 (180° hinges) 2 internal drawers 1 internal deep drawer place at 5 cm from the side wall</p>		L 60	G654162A1/2	558	601	735		
	 <p>colonna per forno apertura push-pull 1 anta superiore H 96 1 anta inferiore H 72 (cerniere 180°) 2 cestoni interni posizionare a 5 cm dalla parete laterale oven column push-pull opening 1 upper door H 96 1 lower door H 72 (180° hinges) 2 internal deep drawers place at 5 cm from the side wall</p>	L 60	G654163A1/2	515	558	689		
 <p>colonna forno sospesa H 156 per lavastoviglie 1 anta H 96 N.B.: inserire base lavastoviglie L 60 della versione Bridge hanging oven column H 156 for dishwasher 1 door H 96 Note: do insert dishwasher base unit for the Bridge version</p>		L 60	G6577601/2	315	340	381		
	 <p>fianco per colonna sospesa a fine composizione side panel for hanging column placed at the end of the composition</p>							
H 241x59,6x1,8 zoccolo H 13 come anta same as door		T94386	112	—	307			
H 241x59,7x1,9 zoccolo H 13 laccato come anta lacquered same as door		T94387	—	169	—			

COLONNE PER FORNO H 241

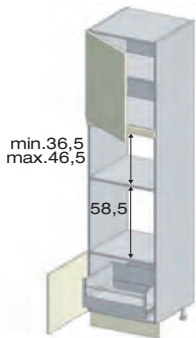
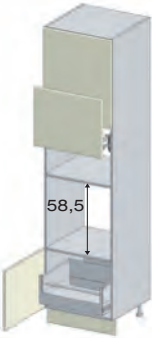
P 59,5

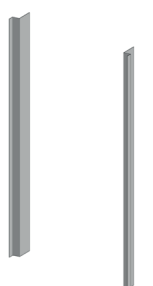

OVEN COLUMNS H 241

		COD.	NECK MELAMI- NICO KT5	NECK LACCATO KT6	NECK WOOD KT4			
<p>N.B.: cassetti e cestoni ad estrazione totale con blumotion Note: fully extending drawers and deep drawers with blumotion system</p>								
 <p>colonna per forno e micro apertura push-pull 1 anta superiore a misura 1 anta inferiore H 48 (cerniere 180°) 1 cestone interno vano micro da H 36,5 a 46,5 posizionare a 5 cm dalla parete laterale oven and microwave column push-pull opening 1 upper door made to size 1 lower door H 48 (180° hinges) 1 internal deep drawer microwave compartment H 36,5 to 46,5 place at 5 cm from the side wall</p>	L 60	G6562611/2	455	483	523			
 <p>colonna per forno - 1 anta superiore H 72 1 anta H 48 sollevamento verticale 1 anta inferiore H 48 (cerniere 180°) 1 cestone interno posizionare a 5 cm dalla parete laterale N.B.: in base alla composizione è obbligatorio inserire nella colonna con anta sollevamento verticale, gola tipo "D" per permettere l'apertura della stessa oven column - 1 upper door H 72 1 door H 48 vertical opening 1 lower door H 48 (180° hinges) 1 internal deep drawer place at 5 cm from the side wall Note: based on the composition, a type "D" finger rail must be fitted to the column with vertical opening door to allow it to open</p>	L 60	G6564601/2	618	664	759			
 <p>colonna per forno e lavastoviglie Electrolux KESC 5300L - AEG FSE63307P 1 anta superiore H 72 1 anta lavastoviglie H 72 1 cassetto H 24 N.B.: in base alla composizione è obbligatorio inserire nella colonna con lavastoviglie, gola tipo "D" per permettere l'apertura della stessa column for oven and Electrolux KESC 5300L - AEG FSE63307P dishwasher 1 upper door H 72 1 dishwasher door H 72 1 drawer H 24 Note: based on the composition, a type "D" finger rail must be fitted to the column with dishwasher to allow it to open</p>	L 60	G6575601/2	415	459	568			
 <p>profilo in acciaio a "L" per rifinire il ripiano del forno e microonde L-shaped steel finishing profile for shelf of oven and microwave</p> 	L 60							
		inox stainless steel	08660100	9	9	9		
		nero black	08660101	9	9	9		
		bianco white	08660102	9	9	9		
 <p>kit protezione fianchi per forno protection kit sides for oven</p> 	coppia couple	08630095	16	16	16			

COLONNE PER FRIGO H 145 - 217

P 59,5

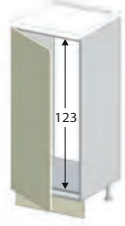
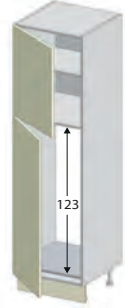
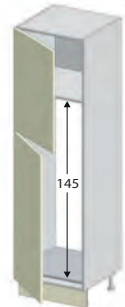
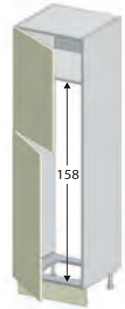

FRIDGE COLUMNS H 145 - 217

Le colonne non sono comprensive di top The columns do not include the tops		COD.	NECK MELAMI- NICO KT5	NECK LACCATO KT6	NECK WOOD KT4			
 <p>colonna H 145 per frigo 215 monoporta column H 145 for single-door fridge 215</p>								
	L 60	G6452151/2	252	287	361			
 <p>colonna H 217 per frigo 215 monoporta 1 anta superiore H 72 1 anta inferiore H 132 column H 217 for 215 single-door fridge 1 upper door H 72 1 lower door H 132</p>								
	L 60	G646215A1/2	322	378	495			
 <p>colonna H 217 per frigo-freezer 230 1 anta superiore H 84 1 anta inferiore H 120 column H 217 for 230 fridge-freezer 1 upper door H 84 1 lower door H 120</p>								
	L 60	G646231A1/2	322	378	495			
 <p>colonna H 217 per frigo-freezer 280 1 anta superiore H 84 1 anta inferiore H 120 column H 217 for 280 fridge-freezer 1 upper door H 84 1 lower door H 120</p>								
	L 60	G646286A1/2	322	378	495			
 <p>colonna H 217 per frigo-congelatore 315 1 anta superiore H 132 1 anta inferiore H 72 column H 217 for 315 fridge-freezer 1 upper door H 132 1 lower door H 72</p>								
	L 60	G646315A1/2	322	378	495			
<p>NELLE COLONNE PER L'APERTURA DELLE ANTE E' OBBLIGATORIO L'INSERIMENTO DELLE GOLE VERTICALI VERTICAL FINGER RAILS MUST BE FITTED TO COLUMNS WITH OPENING DOORS</p>								

COLONNE PER FRIGO H 217

FRIDGE COLUMNS H 217

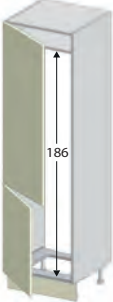
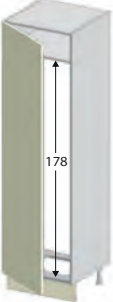
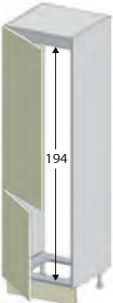



P 59,5

	COD.	NECK MELAMI- NICO KT5	NECK LACCATO KT6	NECK WOOD KT4				
 <p>colonna H 217 per frigo-congelatore 315 3 ante anta superiore H 24 anta centrale H 108 anta inferiore H 72 column H 217 for 315 fridge-freezer 3 doors upper door H 24 central door H 108 lower door H 72</p>	L 60	G6463161/2	341	399	515			
	 <p>colonna H 217 per frigo-congelatore 330 1 anta superiore H 132 1 anta inferiore H 72 column H 217 for 330 fridge-freezer 1 upper door H 132 1 lower door H 72</p>	L 60	G646330A1/2	322	378	495		
 <p>colonna H 217 per frigo-freezer 300 monoporta 1 anta H 204 column H 217 for 300 single-door fridge-freezer 1 door H 204</p>		L 60	G6463001/2	322	378	495		
	 <p>colonna H 217 per frigo-congelatore 350 1 anta superiore H 132 1 anta inferiore H 72 column H 217 for 350 fridge-freezer 1 upper door H 132 1 lower door H 72</p>	L 60	G646350A1/2	322	378	495		
 <p>colonna H 217 per frigo-congelatore 400 1 anta superiore H 132 1 anta inferiore H 72 column H 217 for 400 fridge-freezer 1 upper door H 132 1 lower door H 72</p>		L 75	G646400A1/2	448	514	607		
	<p>NELLE COLONNE PER L'APERTURA DELLE ANTE E' OBBLIGATORIO L'INSERIMENTO DELLE GOLE VERTICALI VERTICAL FINGER RAILS MUST BE FITTED TO COLUMNS WITH OPENING DOORS</p>							

COLONNE PER FRIGO H 241

P 59,5



FRIDGE COLUMNS H 241



	COD.	NECK MELAMI- NICO KT5	NECK LACCATO KT6	NECK WOOD KT4			
 <p>colonna H 241 per frigo 215 monoporta 1 anta superiore H 96 1 anta inferiore H 132 column H 241 for 215 single-door fridge 1 upper door H 96 1 lower door H 132</p>	L 60	G647215A1/2	343	405	535		
 <p>colonna H 241 per frigo-freezer 230 1 anta superiore H 108 1 anta inferiore H 120 column H 241 for 230 fridge-freezer 1 upper door H 108 1 lower door H 120</p>	L 60	G647231A1/2	343	405	535		
 <p>colonna H 241 per frigo-freezer 280 1 anta superiore H 108 1 anta inferiore H 120 column H 241 for 280 fridge-freezer 1 upper door H 108 1 lower door H 120</p>	L 60	G647286A1/2	343	405	535		
 <p>colonna H 241 per frigo-congelatore 315 1 anta superiore H 156 1 anta inferiore H 72 column H 241 for 315 fridge-freezer 1 upper door H 156 1 lower door H 72</p>	L 60	G647315A1/2	343	405	535		
 <p>colonna H 241 per frigo-congelatore 315 3 ante anta superiore H 48 anta centrale H 108 anta inferiore H 72 column H 241 for 315 fridge-freezer 3 doors upper door H 48 central door H 108 lower door H 72</p>	L 60	G6473161/2	364	428	557		
<p>NELLE COLONNE PER L'APERTURA DELLE ANTE E' OBBLIGATORIO L'INSERIMENTO DELLE GOLE VERTICALI VERTICAL FINGER RAILS MUST BE FITTED TO COLUMNS WITH OPENING DOORS</p>							

COLONNE PER FRIGO H 241

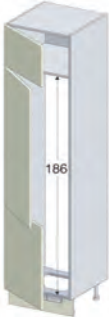
P 59,5

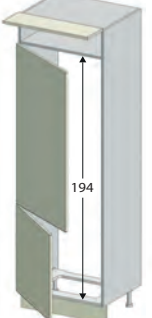
FRIDGE COLUMNS H 241

	COD.	NECK MELAMI- NICO KT5	NECK LACCATO KT6	NECK WOOD KT4				
 <p>colonna H 241 per frigo-congelatore 330 1 anta superiore H 156 1 anta inferiore H 72 column H 241 for 330 fridge-freezer 1 upper door H 156 1 lower door H 72</p>								
	L 60	G647330A1/2	343	405	535			
 <p>colonna H 241 per frigo-congelatore 330 1 anta superiore H 36 1 anta centrale H 120 1 anta inferiore H 72 column H 241 for 330 fridge-freezer 1 upper door H 36 1 central door H 120 1 lower door H 72</p>								
	L 60	G6473361/2	364	405	557			
 <p>colonna H 241 per frigo-congelatore 300 monoporta 1 anta superiore H 48 1 anta inferiore H 180 column H 241 for 300 single-door fridge-freezer 1 upper door H 48 1 lower door H 180</p>								
	L 60	G6473001/2	343	405	535			
 <p>colonna H 241 per frigo-congelatore 350 1 anta superiore H 156 1 anta inferiore H 72 column H 241 for 350 fridge-freezer 1 upper door H 156 1 lower door H 72</p>								
	L 60	G647350A1/2	343	405	535			
 <p>colonna H 241 per frigo-congelatore 400 1 anta superiore a ribalta H 24 TIP-ON 1 anta centrale H 132 1 anta inferiore H 72 column H 241 for 400 fridge-freezer 1 upper flap door H 24 TIP-ON opening 1 central door H 132 1 lower door H 72</p>								
	L 75	G6474101/2	578	652	758			
<p>NELLE COLONNE PER L'APERTURA DELLE ANTE E' OBBLIGATORIO L'INSERIMENTO DELLE GOLE VERTICALI VERTICAL FINGER RAILS MUST BE FITTED TO COLUMNS WITH OPENING DOORS</p>								

		COD.	NECK MELAMI- NICO KT5	NECK LACCATO KT6	NECK WOOD KT4				
 <p>sopracolonna 1 anta top column 1 door</p>	H 36 L 30	GC601301/2	134	135	145				
	L 45	GC601451/2	131	140	151				
	L 60	GC601601/2	145	156	169				
	ribalta TIP-ON L 75	GC61076T	230	246	272				
	H 48 L 30	GC602301/2	168	171	171				
	L 45	GC602451/2	170	180	182				
	L 60	GC602601/2	187	200	207				
	ribalta TIP-ON L 75	GC61276T	275	295	319				
	 <p>sopracolonna 1 anta vetro top column 1 glass door</p>	telaio alluminio H 36 L 45	GC605461/2	208	208	208			
		L 60	GC605611/2	231	231	231			
H 48 L 45		GC606461/2	236	236	236				
L 60		GC606611/2	291	291	291				
telaio melaminico H 36 L 45		GC605451/2	233	—	—				
L 60		GC605601/2	264	—	—				
H 48 L 45		GC606451/2	263	—	—				
L 60		GC606601/2	326	—	—				
 <p>gola verticale e fianco per colonna vertical finger rail and side panel for column</p>	gola verticale ELLE tipo "C" al ml ELLE vertical finger rail type "C" per lm								
	H 240	G950390	144	144	144				
	H 252	G950390	152	152	152				
	gola verticale ELLE tipo "E" al ml ELLE vertical finger rail type "E" per lm								
	H 240	G950590	144	144	144				
	H 252	G950590	152	152	152				
	fianco side panel								
	H 239,7x59,6x1,8	T94384	112	—	304				
	H 239,7x59,7x1,9	T94385	—	169	—				
	H 251,7x59,6x1,8	T94390	120	—	317				
H 251,7x59,7x1,9	T94391	—	176	—					

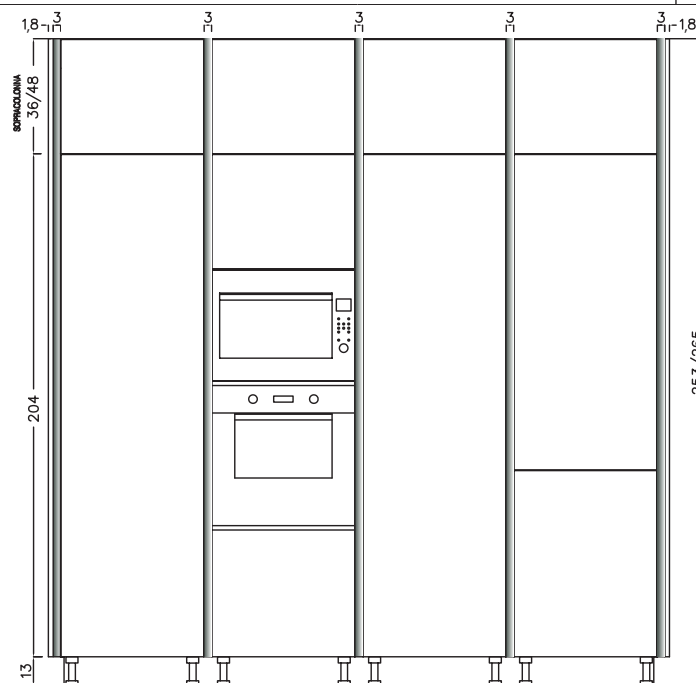

N.B.: il sistema a ponte può essere realizzato solo tra due colonne
 Note: the bridge system realized only between 2 columns

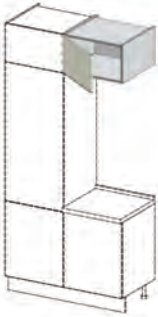
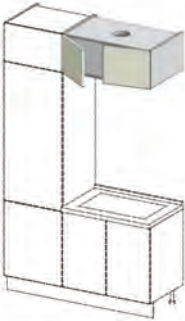
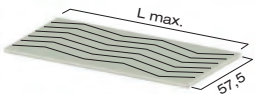
	COD.	NECK MELAMI- NICO KT5	NECK LACCATO KT6	NECK WOOD KT4				
 <p>sopracolonna per sistema ponte 1 anta top column for bridge system 1 door</p>	H 36 L 45	GC601461/2	131	140	155			
	L 60	GC601611/2	145	156	174			
	2 ante L 90	GC601910	191	207	236			
	H 48 L 45	GC602461/2	170	180	199			
	L 60	GC602611/2	187	200	224			
	2 ante L 90	GC602910	214	234	274			
 <p>cappa aspirante integrata totale con luce led e comando remoto, 2 ante - L 90 portata 696 m³/h classe energetica A - L 120 portata 730 m³/h classe energetica B (depuratore fornito smontato) fully integrated extractor hood with bar led and remote control, 2 doors - W 90 air flow rate 696 m³/h energetic class A - W 120 air flow rate 730 m³/h energetic class B (purifier supplied unassembled)</p>	H 36 L 90	GPC00900	1.297	1.312	1.336			
	L 120	GPC01200	1.656	1.676	1.720			
	H 48 L 90	GPC01900	1.326	1.346	1.380			
	L 120	GPC02200	1.687	1.713	1.771			
	L.max 275 melaminico max.lenght 275 melamine	094506	121	—	—			
L.max 275 laccato max.lenght 275 lacquered	094529	—	171	—				
L.max 275 impiallacciato max.lenght 275 veneered	094520W	—	—	214				
 <p>pannello di finitura come anta sp.1,8 venature orizzontali finishing panel same as door th.1,8 horizontal grains</p>								

CAPPA PER SOPRACOLONNA



DETTAGLIO PANNELLO

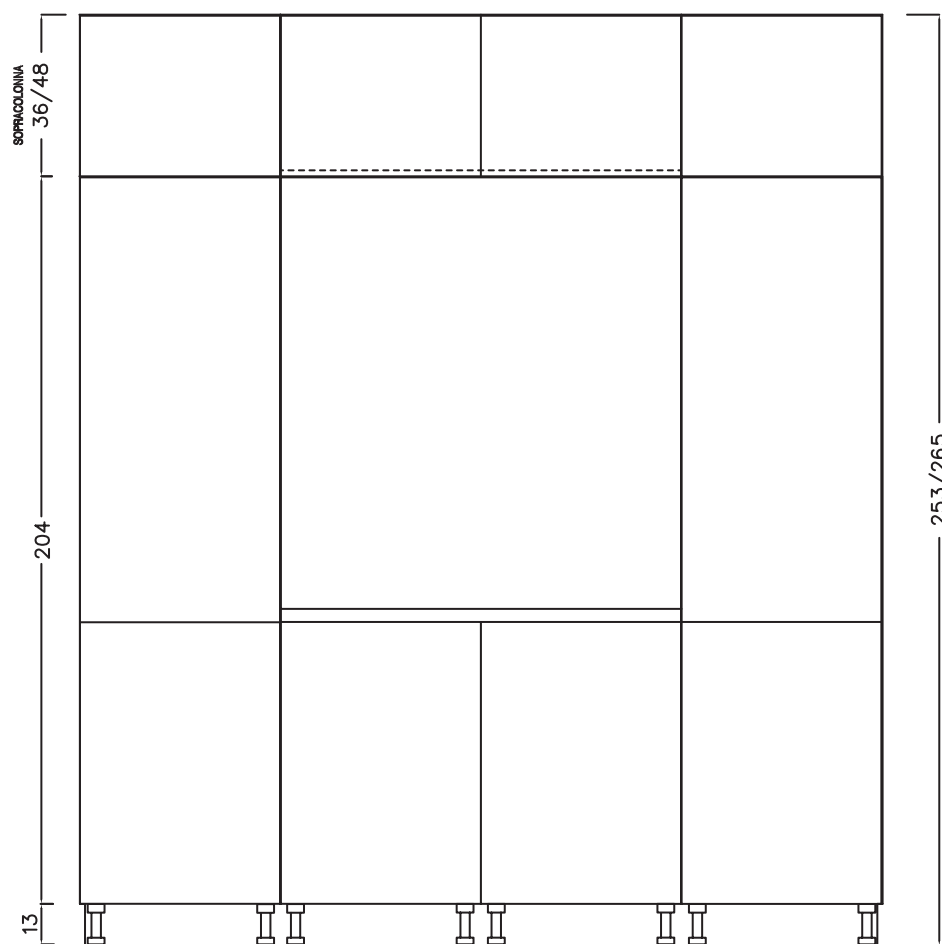
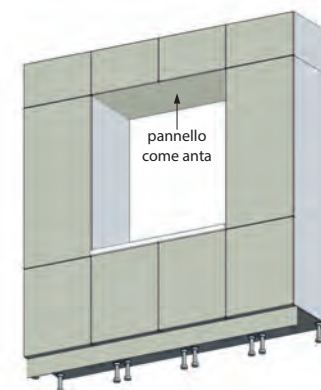



Con lo **zoccolo** ad altezza ridotta a 6 cm, si possono **guadagnare centimetri preziosi di contenimento**, dando alla cucina l'aspetto elegante di un living.

Valuable space has been saved by lowering the plinth to 6 cm, and so the kitchen will take on a stylish look such as a living room.



tablet Neck

strutture carcasses

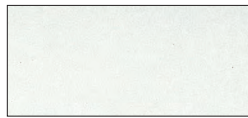

bianco (opz.001)
schiena e ripiano bianco
(opz.001)
white
white back panel and shelf



conchiglia (opz.8910)
schiena e ripiano conchiglia
(opz.8910)
shell
shell back panel and shelf



lavagna (opz.9620)
schiena e ripiano lavagna
(opz.9620)
slate grey
slate grey back panel and shelf



fango (opz.8860)
schiena e ripiano fango
(opz.8860)
mud
mud back panel and shelf



visone (opz.948M)
schiena e ripiano visone
(opz.948M)
mink
mink back panel and shelf



argilla (opz.9690)
schiena e ripiano argilla
(opz.9690)
clay (opt.9690)
clay back panel and shelf
(opt.9690)

zoccoli in alluminio H 6 aluminium plinths H 6

di serie
standard



alluminio finitura
brill (opz.412)
aluminium brill finish
(opt.412)



alluminio finitura titanio
ossidato (opz.414)
aluminium titanium
oxidized finish (opt.414)

zoccoli in alluminio H 6 verniciati a polvere finitura opaca aluminum plinths H 6 powder coated matt finish

magg. rispetto allo zoccolo standard
surcharges compared to standard plinth



alluminio finitura
bianco assoluto
(opz.740S)
aluminium absolute
white finish (opt.740S)



alluminio finitura
grigio selce (opz.SE)
aluminium flint grey
finish (opt.SE)



alluminio finitura
silver dark (opz.9507)
aluminium dark silver
finish (opt.9507)



alluminio finitura
ghisa (opz.9509)
aluminium cast iron
finish (opt.9509)

al ml
per lm
cod.092085
code
+35 €

angolare
angular
cod.0923903
code
+4 €



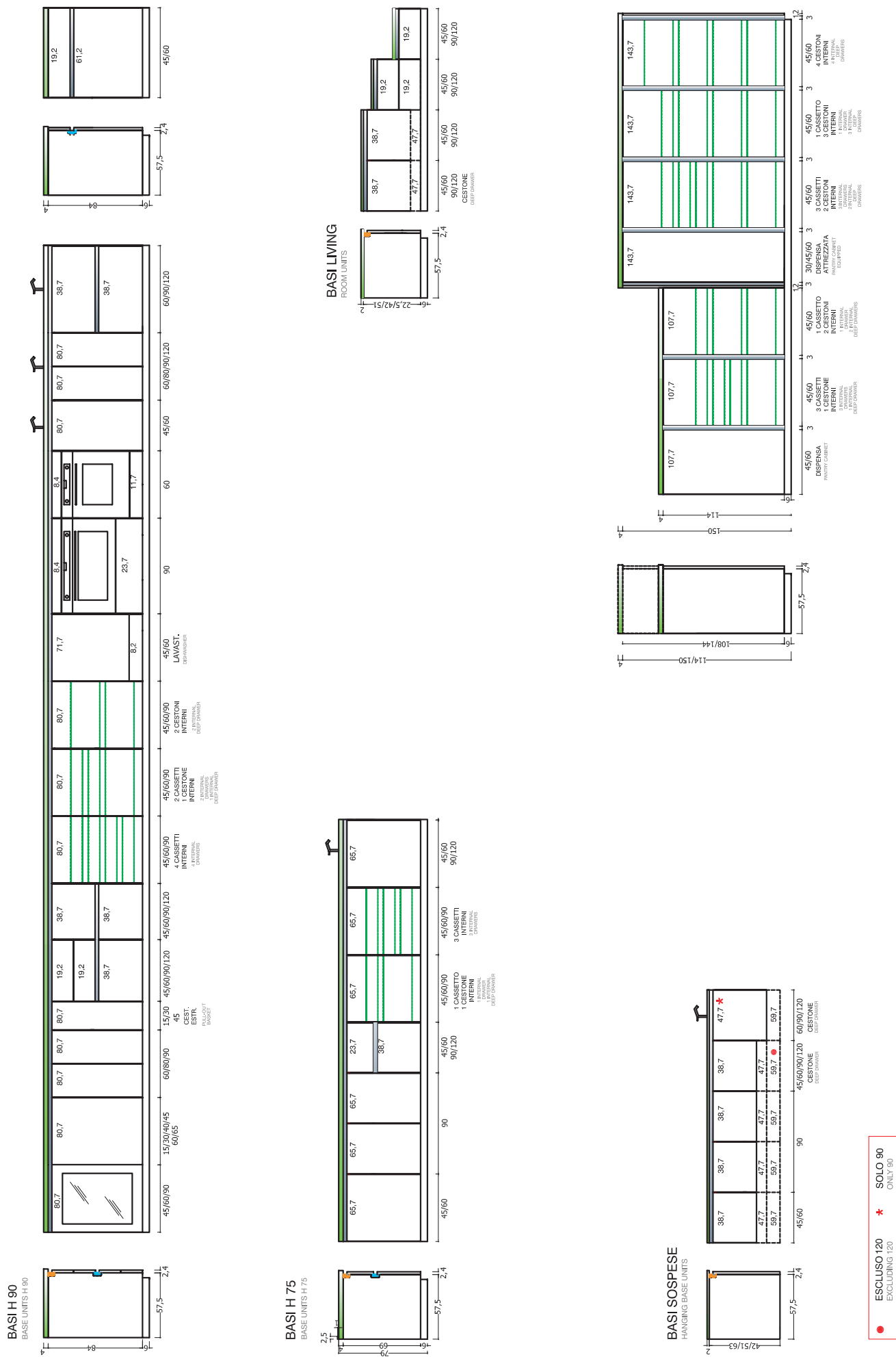



MODULARITÀ E COMPONENTIBILITÀ MODULARITÀ MODULARITY AND FITTING SOLUTIONS



BASI CON ZOCCOLO H 6

H 90 P 61

BASE UNITS WITH PLINTH H 6



LE BASI NON SONO COMPRENSIVE DI TOP/N.B.: cassetti e cestoni con blumotion THE BASE UNITS DO NOT INCLUDE THE TOPS/Note: drawers and deep drawers with blumotion system		COD.	NECK MELAMI- NICO KT5	NECK LACCATO KT6	NECK WOOD KT4			
 <p>fascia tamponamento filler panel</p>								
	L da 3 a 15 size from 3 to 15	GB800000	78	80	96			
 <p>jolly base L da 10 a 30 jolly base unit size from 10 to 30</p>								
	colore come struttura same colour as carcass	GB700000	150	150	150			
	melaminico come anta melamine same as door	GB700030	224	—	—			
	impiallacciato come anta (folding) veneered same as door (folding)	GB730020	—	—	654			
 <p>1 anta H 80,7 1 door H 80,7</p>								
	L 15	GB010151/2	136	147	162			
	L 30	GB010301/2	160	174	190			
	L 40	GB010401/2	182	196	219			
	L 45	GB010451/2	192	205	233			
	L 60	GB010601/2	229	245	282			
	L 65	GB010651/2	250	270	299			
 <p>2 ante H 80,7 2 doors H 80,7</p>								
	L 60	GB010600	243	263	301			
	L 80	GB010800	287	310	361			
	L 90	GB010900	312	337	394			
 <p>cestello estraibile chiusura soft pull-out basket unit soft-closing system</p>								
	L 15	GB150150	172	183	185			
	L 30	GB150300	223	240	253			
	L 45	GB150450	255	273	296			
 <p>1 cassetto H 19,2 1 anta H 61,2 N.B.: senza gola superiore 1 drawer H 19,2 1 door H 61,2 Note: without upper finger rail</p>								
	L 45	GB021451/2	256	269	293			
	L 60	GB021601/2	286	305	339			

BASI CON ZOCCOLO H 6

H 90 P 61

BASE UNITS WITH PLINTH H 6

LE BASI NON SONO COMPRENSIVE DI TOP/N.B.: cassetti e cestoni con blumotion
 THE BASE UNITS DO NOT INCLUDE THE TOPS/Note: drawers and deep drawers with blumotion system

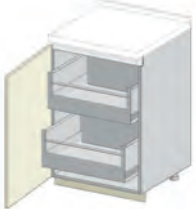

		COD.	NECK MELAMI- NICO KT5	NECK LACCATO KT6	NECK WOOD KT4			
 <p>2 cassetti H 19,2 1 cestone H 38,7 2 drawers H 19,2 1 deep drawer H 38,7</p>	L 45	GB131450	368	370	404			
	L 60	GB131600	406	417	459			
	L 90	GB131900	497	513	577			
	L 120	GB132200	607	615	—			
 <p>2 cestoni H 38,7 2 deep drawers H 38,7</p>	L 45	GB171450	323	342	356			
	L 60	GB171600	352	384	408			
	L 90	GB171900	434	473	517			
	L 120	GB172200	554	571	—			
 <p>1 anta H 80,7 2 cassetti interni 1 cestone interno posizionare a 5 cm dalla parete laterale 1 door H 80,7 2 internal drawers 1 internal deep drawer place at 5 cm from the side wall</p>	L 45	GB236461/2	372	387	429			
	L 60	GB236611/2	420	439	495			
 <p>1 anta H 80,7 2 cestoni interni posizionare a 5 cm dalla parete laterale 1 door H 80,7 2 internal deep drawers place at 5 cm from the side wall</p>	L 45	GB236471/2	333	347	389			
	L 60	GB236621/2	376	395	451			

BASI ANGOLO CON ZOCCOLO H 6

H 90 P 65

CORNER BASE UNITS WITH PLINTH H 6



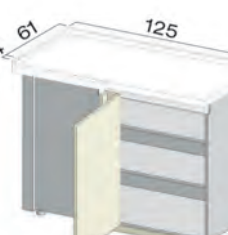
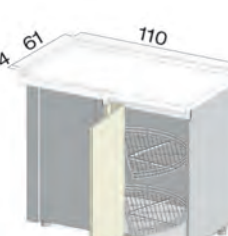
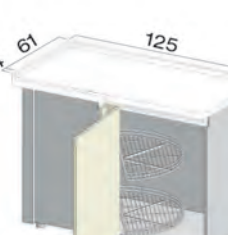

LE BASI NON SONO COMPRENSIVE DI TOP
THE BASE UNITS DO NOT INCLUDE THE TOPS

			NECK MELAMI- NICO KT5	NECK LACCATO KT6	NECK WOOD KT4			
 <p>angolo L 95 2 ripiani 1 anta L 30 H 80,7 cassone 90 corner unit W 95 2 shelves 1 door W 30 H 80,7 structure 90</p> <p>verso dx RH version</p>	95x65	GB400951/2	387	399	405			
 <p>angolo L 105 2 ripiani 1 anta L 40 H 80,7 cassone 90 corner unit W 105 2 shelves 1 door W 40 H 80,7 structure 90</p> <p>verso dx RH version</p>	105x65	GB401041/2	401	414	423			
 <p>angolo L 110 2 ripiani 1 anta L 45 H 80,7 cassone 105 corner unit W 110 2 shelves 1 door W 45 H 80,7 structure 105</p> <p>verso dx RH version</p>	110x65	GB401091/2	423	450	446			
 <p>angolo L 125 2 ripiani 1 anta L 60 H 80,7 cassone 120 con tirante corner unit W 125 2 shelves 1 door W 60 H 80,7 structure 120 with tie beam</p> <p>verso dx RH version</p>	125x65	GB401241/2	431	461	523			
 <p>angolo L 110 2 cestelli mezzaluna orion grau 1 anta L 45 H 80,7 cassone 105 corner unit W 110 2 crescent-shaped orion grau wire basket units 1 door W 45 H 80,7 structure 105</p> <p>verso dx RH version</p>	110x65	GB401111/2	438	473	462			
 <p>angolo L 125 2 cestelli mezzaluna orion grau 1 anta L 60 H 80,7 cassone 120 corner unit W 125 2 crescent-shaped orion grau wire basket units 1 door W 60 H 80,7 structure 120</p> <p>verso dx RH version</p>	125x65	GB401261/2	465	502	504			

BASI ANGOLO CON ZOCCOLO H 6

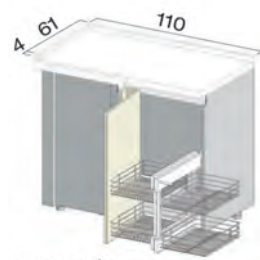
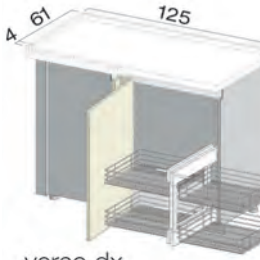
H 90 P 65

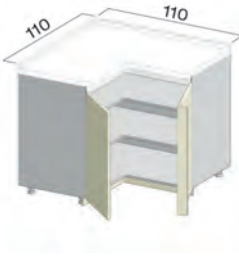

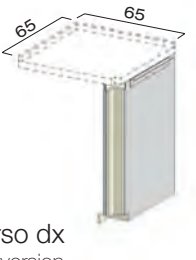
CORNER BASE UNITS WITH PLINTH H 6

LE BASI NON SONO COMPRENSIVE DI TOP THE BASE UNITS DO NOT INCLUDE THE TOPS		COD.	NECK MELAMI- NICO KT5	NECK LACCATO KT6	NECK WOOD KT4			
 <p>angolo L 110 4 cestelli orion grau estraibili indipendenti dall'anta 1 anta L 45 H 80,7 cassone 105 corner unit W 110 4 pull-out orion grau basket units opening independently from door 1 door W 45 H 80,7 structure 105</p> <p>verso dx RH version</p>	110x65	GB451101/2	964	983	952			
	 <p>angolo L 125 4 cestelli orion grau estraibili indipendenti dall'anta 1 anta L 60 H 80,7 cassone 120 corner unit W 125 4 pull-out orion grau basket units opening independently from door 1 door W 60 H 80,7 structure 120</p> <p>verso dx RH version</p>	125x65	GB451251/2	1.042	1.062	1.037		
 <p>angolo 95x95 2 ripiani 2 ante L 30 H 80,7 (cerniere 180°) angolare unito all'anta dx corner unit 95x95 2 shelves 2 doors W 30 H 80,7 (180° hinges) angular filler attached to the RH door</p>	95x95	GB481950	785	820	761			
	 <p>angolo 110x110 2 ripiani 2 ante L 45 H 80,7 (cerniere 180°) angolare unito all'anta dx corner unit 110x110 2 shelves 2 doors W 45 H 80,7 (180° hinges) angular filler attached to the RH door</p>	110x110	GB482100	871	915	864		
 <p>angolo 65x65 con supporto N.B.: solo angolare corner unit 65x65 with support Note: only angular filler</p>	65x65	GB480650	196	147	139			
	 <p>angolo 65x65 con supporto per inserimento lavastoviglie destra o sinistra N.B.: solo angolare con fianco corner unit 65x65 with support for dishwasher placed on the right or the left side Note: only angular filler with side</p> <p>verso dx RH version</p>	65x65	GB480651/2	244	170	175		

BASI ANGOLO CON PANNELLO COME ANTA E ZOCCOLO H 6

H 90 P 61

CORNER BASE UNITS WITH FIXED PANEL SAME AS DOOR AND PLINTH H 6

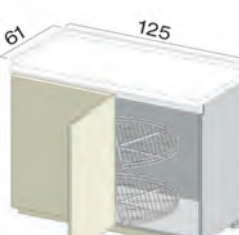
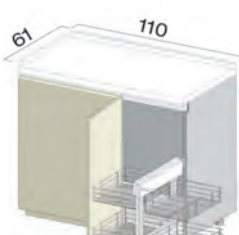
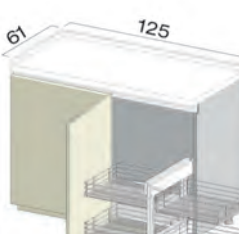
LE BASI NON SONO COMPRENSIVE DI TOP THE BASE UNITS DO NOT INCLUDE THE TOPS		COD.	NECK MELAMI- NICO KT5	NECK LACCATO KT6	NECK WOOD KT4			
 <p>angolo L 110 2 ripiani 1 anta L 45 H 80,7 pannello come anta cassone 110 corner unit W 110 2 shelves 1 door W 45 H 80,7 panel as door structure 110</p> <p>verso dx RH version</p>	110x61	GB403091/2	403	426	460			
 <p>angolo L 125 2 ripiani 1 anta L 60 H 80,7 pannello come anta cassone 125 con tirante corner unit W 125 2 shelves 1 door W 60 H 80,7 panel as door structure 125 with tie beam</p> <p>verso dx RH version</p>	125x61	GB403241/2	431	455	527			
 <p>angolo L 110 2 cestelli mezzaluna orion grau 1 anta L 45 H 80,7 pannello come anta cassone 110 corner unit W 110 2 crescent-shaped orion grau wire basket units 1 door W 45 H 80,7 panel as door structure 110</p> <p>verso dx RH version</p>	110x61	GB403111/2	403	440	486			
 <p>angolo L 125 2 cestelli mezzaluna orion grau 1 anta L 60 H 80,7 pannello come anta cassone 125 corner unit W 125 2 crescent-shaped orion grau wire basket units 1 door W 60 H 80,7 panel as door structure 125</p> <p>verso dx RH version</p>	125x61	GB403261/2	431	465	532			
 <p>angolo L 110 4 cestelli orion grau estraibili indipendenti dall'anta 1 anta L 45 H 80,7 pannello come anta cassone 110 corner unit W 110 4 pull-out orion grau basket units opening independently from door 1 door W 45 H 80,7 panel as door structure 110</p> <p>verso dx RH version</p>	110x61	GB453101/2	929	950	976			
 <p>angolo L 125 4 cestelli orion grau estraibili indipendenti dall'anta 1 anta L 60 H 80,7 pannello come anta cassone 125 corner unit W 125 4 pull-out orion grau basket unit opening independently from door 1 door W 60 H 80,7 panel as door structure 125</p> <p>verso dx RH version</p>	125x61	GB453251/2	1.008	1.025	1.065			

BASI PER FORNI CON ZOCCOLO H 6

H 90 P 61

OVEN BASE UNITS WITH PLINTH H 6







LE BASI NON SONO COMPRENSIVE DI TOP THE BASE UNITS DO NOT INCLUDE THE TOPS		COD.	NECK MELAMI- NICO KT5	NECK LACCATO KT6	NECK WOOD KT4			
 <p>base per forno elettrico H 60 1 frontale superiore fisso H 8,4 1 cassetto H 12 inferiore presa su fondo electric oven base unit H 60 1 fixed upper front H 8,4 1 lower drawer H 12 grip on bottom opening</p>	L 60	GF510620	165	199	288			
	 <p>base per forno elettrico H 60 1 frontale superiore fisso H 11,7 1 frontale inferiore fisso H 8,4 N.B.: consigliata per allineamento con base lavastoviglie electric oven base unit H 60 1 fixed upper front H 11,7 1 fixed lower front H 8,4 Note: advised for alignment with dishwasher base unit</p>	L 60	GF510630	193	195	204		
 <p>base per maxiforno H 46 1 frontale superiore fisso H 8,4 1 cassetto H 24 inferiore presa su fondo electric maxi-oven base unit H 46 1 fixed upper front H 8,4 1 lower drawer H 24 grip on bottom opening</p>		L 90	GF510925	347	361	269		
	 <p>kit raccordo base angolo junction kit for corner base unit</p>	110x110	GF471100	236	256	257		
 <p>kit raccordo base angolo per inserimento lavastoviglie a destra o sinistra junction kit for corner base unit for dishwasher placed on the right or the left side</p> <p>verso dx RH version</p>		110x110	GF471151/2	274	292	295		
	<p>NELLE INTERRUZIONI DI GOLA, AGGIUNGERE SEMPRE I RELATIVI TERMINALI ADD THE ASSOCIATED CLOSURES TO ANY INTERRUPTIONS IN THE FINGER RAIL</p>							

BASI PER PIANI COTTURA CON ZOCCOLO H 6

H 90 P 61

COOKER HOB BASE UNITS WITH PLINTH H 6





LE BASI NON SONO COMPRENSIVE DI TOP/N.B.: cassetti e cestoni con blumotion
 THE BASE UNITS DO NOT INCLUDE THE TOPS/Note: drawers and deep drawers with blumotion system

	COD.	NECK MELAMI- NICO KT5	NECK LACCATO KT6	NECK WOOD KT4			
 <p>base predisposta piano cottura 1 anta H 80,7 2 ripiani base unit configured for cooker hob 1 door H 80,7 2 shelves</p>	L 60	GF500601/2	229	245	282		
		opz.101	+55	+55	+55		
			mag.base piano cottura ad induzione surcharge base unit for induction cooker hob				
 <p>base predisposta piano cottura 2 ante H 80,7 2 ripiani base unit configured for cooker hob 2 doors H 80,7 2 shelves</p>	L 90	GF500900	312	332	394		
		opz.101	+55	+55	+55		
			mag.base piano cottura ad induzione surcharge base unit for induction cooker hob				
 <p>Maggiorazione per base predisposta piano cottura ad induzione con lamierino di protezione N.B.: realizzabile su base 2 cassetti+1 cestone e base 2 cestoni Surcharge for base unit configured for induction cooker hob with protection metal sheet Note: available on base unit 2 drawers+1 deep drawer and base unit 2 deep drawers</p>		opz.101	+55	+55	+55		
			mag.base piano cottura ad induzione surcharge base unit for induction cooker hob				
 <p>base predisposta piano cottura con cappa integrata 1 frontale superiore fisso H 19,2 1 cassetto H 19,2 P 40 1 cestone H 38,7 P 40 base unit configured for cooker hob with integrated hood 1 fixed upper front H 19,2 1 drawer H 19,2 D 40 1 deep drawer H 38,7 D 40</p>	L 90	GF509090	452	471	580		
	L 120	GF509120	551	576	—		
			mag.base piano cottura ad induzione surcharge base unit for induction cooker hob				
 <p>base predisposta piano cottura con cappa integrata 2 cestoni H 38,7 P 40 base unit configured for cooker hob with integrated hood 2 deep drawers H 38,7 D 40</p>	L 90	GF509095	461	488	578		
	L 120	GF509125	552	592	—		
			mag.base piano cottura ad induzione surcharge base unit for induction cooker hob				
 <p>Esempio di piano cottura con cappa integrata Example of cooker hob with integrated hood</p>							
			mag.base piano cottura ad induzione surcharge base unit for induction cooker hob				

SOTTOLAVELLI CON ZOCCOLO H 6

H 90 P 61

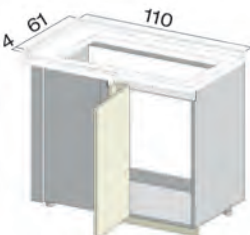
SINK BASE UNITS WITH PLINTH H 6

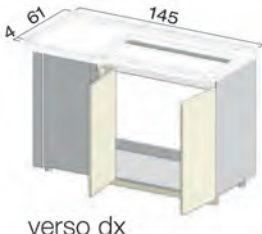
LE BASI NON SONO COMPRENSIVE DI TOP THE BASE UNITS DO NOT INCLUDE THE TOPS		COD.	NECK MELAMI- NICO KT5	NECK LACCATO KT6	NECK WOOD KT4			
 <p>sottolavello 1 anta H 80,7 sink base unit 1 door H 80,7</p>	L 45	GS010451/2	203	211	220			
	L 60	GS010601/2	234	241	263			
 <p>sottolavello 2 ante H 80,7 sink base unit 2 doors H 80,7</p>	L 60	GS010600	247	267	282			
	L 80	GS010800	291	315	339			
	L 90	GS010900	308	333	365			
	L 120	GS011200	374	404	457			
 <p>sottolavello 2 cestoni 1 cestone superiore H 38,7 sagomato con vaschette 1 cestone inferiore H 38,7 sink base unit 2 deep drawers 1 contoured upper deep drawer H 38,7 with trays 1 lower deep drawer H 38,7</p>	L 60	GS200600	394	419	438			
	L 90	GS200900	468	506	555			
	L 120	GS201200	588	605	—			
 <p>sottolavello angolo L 110 1 anta L 45 H 80,7 cassone 105 corner sink base unit W 110 1 door W 45 H 80,7 structure 105</p> <p>verso dx RH version</p>	110x65	GS421101/2	367	423	399			
	 <p>sottolavello angolo L 125 1 anta L 60 H 80,7 cassone 120 corner sink base unit W 125 1 door W 60 H 80,7 structure 120</p> <p>verso dx RH version</p>	125x65	GS421251/2	395	456	435		
 <p>sottolavello angolo L 145 2 ante L 40 H 80,7 cassone 140 corner sink base unit W 145 2 doors W 40 H 80,7 structure 140</p> <p>verso dx RH version</p>		145x65	GS421451/2	477	515	516		

SOTTOLAVELLI CON ZOCCOLO H 6

H 90 P 61

SINK BASE UNITS WITH PLINTH H 6

LE BASI NON SONO COMPRENSIVE DI TOP
THE BASE UNITS DO NOT INCLUDE THE TOPS

COD.

NECK
MELAMI-
NICO
KT5

NECK
LACCATO
KT6

NECK
WOOD
KT4

sottolavello angolo L 155
2 ante L 45 H 80,7
cassone 150

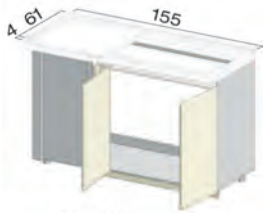

verso dx
RH version

corner sink base unit W 155
2 doors W 45 H 80,7
structure 150

155x65

GS421551/2

493

533

538

sottolavello angolo 95x95
2 ante L 30 (cerniere 180°)
angolare unito all'anta dx

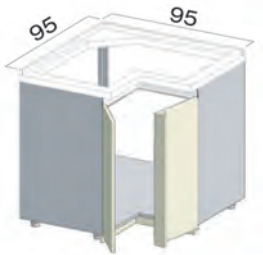

corner sink base unit 95x95
2 doors W 30 (180° hinges)
angular filler attached to the RH door

95x95

GS021950

674

728

702

sottolavello angolo 110x110
2 ante L 45 (cerniere 180°)
angolare unito all'anta dx

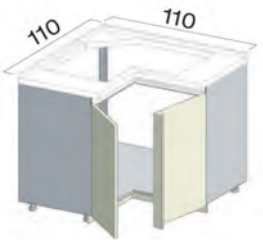

corner sink base unit 110x110
2 doors W 45 (180° hinges)
angular filler attached to the RH door

110x110

GS022100

752

802







811

NELLE INTERRUZIONI DI GOLA, AGGIUNGERE
SEMPRE I RELATIVI TERMINALI
ADD THE ASSOCIATED CLOSURES TO ANY
INTERRUPTIONS IN THE FINGER RAIL

BASI ELETTRODOMESTICI SOTTOTOP ZOCCOLO H 6

H 90 P 61







BASE UNITS FOR UNDER-TOP APPLIANCES WITH PLINTH H 6

LE BASI NON SONO COMPRENSIVE DI TOP THE BASE UNITS DO NOT INCLUDE THE TOPS		COD.	NECK MELAMI- NICO KT5	NECK LACCATO KT6	NECK WOOD KT4			
 <p>anta H 80,7 per lavastoviglie scomparsa totale con sistema sliding completa di kit protezione fianchi door H 80,7 for fully integrated dishwasher with sliding system with protection kit for side panels</p>	L 60	GL490290	131	154	183			
	 <p>anta per lavastoviglie scomparsa totale H 71,7 con frontale fisso H 8,2 completa di kit protezione fianchi door for fully integrated dishwasher H 71,7 with fixed lower front H 8,2 with protection kit for side panels</p>	L 45	GL490080	190	198	217		
L 60		GL490090	202	214	249			
 <p>anta per lavastoviglie scomparsa totale estetica 2 cestoni completa di kit protezione fianchi door for fully integrated dishwasher 2 deep drawers aesthetic with protection kit for side panels</p>		L 60	GL490300	362	388	400		
	 <p>kit protezione fianchi per lavastoviglie protection kit for side panels for dishwasher</p> 							
 <p>fianco per lavastoviglie a fine composizione side panel for dishwasher placed at the end of the composition</p>	H 90x59,6x1,8 in nobilitato melamine coated	G94605	25	25	25			
	H 90x59,6x1,8 come anta same as door	G94707	78	—	125			
	H 90x59,7x1,9 laccato come anta lacquered same as door	G947071	—	85	—			

BASI E SOTTOLAVELLI H 75 CON ZOCCOLO H 6

H 75 P 61

BASE UNITS AND SINK BASE UNITS H 75 WITH PLINTH H 6







LE BASI NON SONO COMPRENSIVE DI TOP THE BASE UNITS DO NOT INCLUDE THE TOPS		COD.	NECK MELAMI- NICO KT5	NECK LACCATO KT6	NECK WOOD KT4			
 <p>base H 75 1 anta H 65,7 base unit H 75 1 door H 65,7</p>	L 45	GBR00451/2	172	185	203			
	L 60	GBR00601/2	201	215	241			
 <p>base H 75 2 ante H 65,7 base unit H 75 2 doors H 65,7</p>	L 90	GBR00900	276	297	340			
	L 45	GBR10450	305	330	329			
 <p>base H 75 1 cassetto H 23,7 1 cestone H 38,7 base unit H 75 1 drawer H 23,7 1 deep drawer H 38,7</p>	L 60	GBR10600	337	358	372			
	L 90	GBR10900	417	451	472			
	L 120	GBR11200	526	542	—			
	L 45	GBR10450	305	330	329			
 <p>sottolavello H 75 1 anta H 65,7 sink base unit H 75 1 door H 65,7</p>	L 45	GSR00451/2	185	197	213			
	L 60	GSR00601/2	210	223	249			
 <p>sottolavello H 75 2 ante H 65,7 sink base unit H 75 2 doors H 65,7</p>	L 90	GSR00900	283	297	350			
	L 120	GSR01200	338	352	424			
 <p>sottolavello H 75 1 cestone H 65,7 1 cassetto interno sagomato con vaschette sink base unit H 75 1 deep drawer H 65,7 1 contoured internal drawer with trays</p>	L 60	GSR10600	457	470	477			
	L 90	GSR10900	479	514	545			
	L 120	GSR11200	621	640	—			

BASI SOSPESSE con Attaccaglie e Barre Fissaggio a parete

H 42 - 51 - 63 P 61

HANGING BASE UNITS with Hangers and Rods for wall mounting





LE BASI NON SONO COMPRENSIVE DI TOP
THE BASE UNITS DO NOT INCLUDE THE TOPS

	COD.	NECK MELAMI- NICO KT5	NECK LACCATO KT6	NECK WOOD KT4			
 <p>base H 42 1 anta H 38,7 base unit H 42 1 door H 38,7</p>	L 45	GBS01451/2	158	167	177		
	L 60	GBS01601/2	174	181	200		
 <p>base H 51 1 anta H 47,7 base unit H 51 1 door H 47,7</p>	L 45	G4320451/2	160	171	195		
	L 60	G4320601/2	173	186	223		
 <p>base H 63 1 anta H 59,7 base unit H 63 1 door H 59,7</p>	L 45	G4322451/2	162	176	207		
	L 60	G4322601/2	176	193	238		
 <p>base H 42 2 ante H 38,7 base unit H 42 2 doors H 38,7</p>	L 90	GBS01900	228	244	263		
	L 120	GBS02200	258	271	305		
 <p>base H 51 2 ante H 47,7 base unit H 51 2 doors H 47,7</p>	L 90	G4320900	223	244	298		
	L 120	G4321200	254	281	365		
 <p>base H 63 2 ante H 59,7 base unit H 63 2 doors H 59,7</p>	L 90	G4322900	230	255	321		

BASI SOSPENSE con Attaccaglie e Barre Fissaggio a parete

H 42 - 51 - 63 P 61

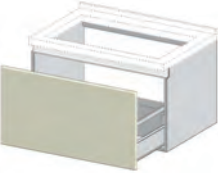
HANGING BASE UNITS with Hangers and Rods for wall mounting

LE BASI NON SONO COMPRENSIVE DI TOP THE BASE UNITS DO NOT INCLUDE THE TOPS		COD.	NECK MELAMI- NICO KT5	NECK LACCATO KT6	NECK WOOD KT4			
 <p>base H 42 1 cestone H 38,7 base H 42 1 deep drawer H 38,7</p>	L 45	GBS11450	219	238	235			
	L 60	GBS11600	234	260	262			
	L 90	GBS11900	280	307	319			
	L 120	GBS12200	339	355	—			
 <p>base H 51 1 cestone H 47,7 base unit H 51 1 deep drawer H 47,7</p>	L 45	G4310450	193	205	243			
	L 60	G4310600	208	222	272			
	L 90	G4310900	243	263	331			
	L 120	G4311200	288	316	—			
 <p>base H 63 1 cestone H 59,7 1 cassetto interno base unit H 63 1 deep drawer H 59,7 1 internal drawer</p>	L 45	G4312450	289	303	353			
	L 60	G4312600	311	328	394			
	L 90	G4312900	363	388	474			
 <p>sottolavello H 51 1 cestone sagomato H 47,7 scarico salvaspazio sink base unit H 51 1 contoured deep drawer H 47,7 space-saver drain piping</p>	L 90	G5240900	290	311	376			
 <p>sottolavello H 63 1 cestone H 59,7 scarico salvaspazio sink base unit H 63 1 deep drawer H 59,7 with space-saver drain piping</p>	L 60	G5250600	259	276	326			
	L 90	G5250900	299	324	388			
	L 120	G5251200	340	370	—			



GOLE PER COLONNE

COLUMNS FINGER RAIL

NELLE COLONNE PER L'APERTURA DELLE ANTE E' OBBLIGATORIO L'INSERIMENTO DELLE GOLE VERTICALI
VERTICAL FINGER RAILS MUST BE FITTED TO COLUMNS WITH OPENING DOORS

COD.

MELAMI-
NICO
KT5

LACCATO
KT6

WOOD
KT0

mezza gola elle verticale tipo "C"
 elle half finger rail type "C"

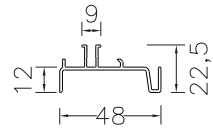

Sezione gola tipo "C"
 Type "C" finger rail section

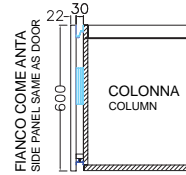

gola
 finger rail

H 108

G950320

72

72

72

H 144

G950340

95

95

95

H 216

G950360

130

130

130

***gola con fianco come anta montato**
 *finger rail mounted on side panel same as door

H 108

G950329

149

169

210

H 144

G950349

181

216

273

H 216

G950369

284

305

391

gola elle verticale intermedia tipo "D"
 elle vertical intermediate finger rail type "D"

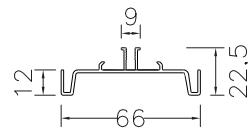

Sezione gola tipo "D"
 Type "D" finger rail section

gola
 finger rail

H 108

G950420

72

72

72

H 144

G950440

95

95

95

H 216

G950460

130

130

130

gola elle verticale laterale tipo "E"
 elle vertical lateral finger rail type "E"

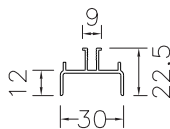

Sezione gola tipo "E"
 Type "E" finger rail section

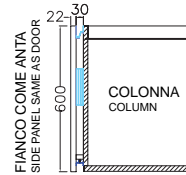

gola
 finger rail

H 108

G950520

72

72

72

H 144

G950540

95

95

95

H 216

G950560

130

130

130

***gola con fianco come anta montato**
 *finger rail mounted on side panel same as door

H 108

G950529

149

169

210

H 144

G950549

181

216

273

H 216

G950569

284



305

391

COLONNE H 114 CON ZOCCOLO H 6

P 59,5

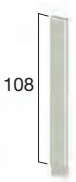





COLUMNS H 114 WITH PLINTH H 6

LE COLONNE NON SONO COMPRENSIVE DI TOP THE COLUMNS DO NOT INCLUDE THE TOPS		COD.	NECK MELAMI- NICO KT5	NECK LACCATO KT6	NECK WOOD KT4			
 <p>fascia tamponamento da 5 a 15 filler panel size from 5 to 15</p> <p>108</p>								
	<p>come anta con supporto same as door with support</p>	GC000140	112	113	119			
 <p>1 anta H 108 1 door H 108</p>								
	L 45	GC040451/2	255	269	280			
	L 60	GC040601/2	285	300	325			
 <p>predisposta per lavastoviglie Electrolux KESC 5300L - AEG FSE63307P anta lavastoviglie H 72 cestone H 36 configured for Electrolux KESC 5300L - AEG FSE63307P dishwasher dishwasher door H 72 deep drawer H 36</p>								
	L 60	GC570600	346	369	398			

COLONNE H 150 CON ZOCCOLO H 6

P 59,5







COLUMNS H 150 WITH PLINTH H 6

LE COLONNE NON SONO COMPRESIVE DI TOP THE COLUMNS DO NOT INCLUDE THE TOPS		COD.	NECK MELAMI- NICO KT5	NECK LACCATO KT6	NECK WOOD KT4			
 <p>fascia tamponamento da 5 a 15 filler panel size from 5 to 15</p> <p>144</p>								
	<p>come anta con supporto same as door with support</p>	GC000150	115	130	138			
 <p>1 anta H 144 1 door H 144</p>								
	L 30	GC050301/2	294	309	298			
	L 45	GC050451/2	320	342	359			
	L 60	GC050601/2	362	387	421			
 <p>1 anta H 144 integrata al gruppo cestelli estraibili in filo orion grau chiusura soft 1 door H 144 incorporated into orion grau wire pull-out basket units soft-closing system</p>								
	L 30	GC150300	541	565	634			
 <p>1 anta H 144 gruppo cestelli estraibili in filo orion grau chiusura soft 1 door H 144 orion grau wire pull-out basket units soft-closing system</p>								
	L 45	GC150451/2	609	621	667			
	L 60	GC150601/2	672	694	778			
 <p>angolo 3 ripiani con tirante 1 anta H 144 pannello come anta corner unit 3 shelves with tie beam 1 door H 144 panel as door</p> <p>65 45-60</p>								
	L 110 P 60	GC336111/2	593	620	717			
	L 125 P 60	GC336261/2	608	657	771			
 <p>jolly colonna L da 10 a 30 jolly column size from 10 to 30</p>								
		EC001000	245	245	245			
		EC001030	351	—	—			
		EC005012	—	—	923			
	<p>colore come struttura same colour as carcass</p> <p>melaminico come anta melamine same as door</p> <p>impiallacciato come anta (folding) veneered same as door (folding)</p>							

COLONNE H 222 CON ZOCCOLO H 6

COLUMNS H 222 WITH PLINTH H 6





P 33 - 59,5

	COD.	NECK MELAMI- NICO KT5	NECK LACCATO KT6	NECK WOOD KT4			
 <p>fascia tamponamento da 5 a 15 filler panel size from 5 to 15</p> <p>216</p>							
	<p>come anta con supporto same as door with support</p> <p>GC000200</p>	140	173	166			
 <p>1 anta H 216 1 door H 216</p>							
	<p>L 45 P 33</p> <p>GC061461/2</p>	357	386	456			
	<p>L 60 P 33</p> <p>GC061611/2</p>	433	451	547			
 <p>1 anta H 216 1 door H 216</p>							
	<p>L 45 P 59,5</p> <p>GC061451/2</p>	437	460	472			
	<p>L 60 P 59,5</p> <p>GC061601/2</p>	494	511	572			
 <p>portascope 1 anta H 216 broom cabinet 1 door H 216</p>							
	<p>L 30 P 59,5</p> <p>GC100311/2</p>	375	396	371			
	<p>L 45 P 59,5</p> <p>GC100461/2</p>	403	423	450			
 <p>portascope con ripiani 1 anta H 216 broom cabinet with shelves 1 door H 216</p>							
	<p>L 60 P 59,5</p> <p>GC100611/2</p>	505	538	599			
 <p>anta H 216 integrata al gruppo cestelli estraibili chiusura soft door H 216 incorporated into the pull-out basket unit soft-closing system</p>							
	<p>L 30 P 59,5</p> <p>GC163300</p>	738	758	819			
	<p>L 45 P 59,5</p> <p>GC163450</p>	802	822	922			

COLONNE H 222 CON ZOCCOLO H 6

P 33 - 59,5





COLUMNS H 222 WITH PLINTH H 6

	COD.	NECK MELAMI- NICO KT5	NECK LACCATO KT6	NECK WOOD KT4			
 <p>1 anta H 216 gruppo cestelli estraibili in filo orion grau chiusura soft 1 door H 216 orion grau wire pull-out basket units soft-closing system</p>	L 45 P 59,5	GC161451/2	688	710	784		
	L 60 P 59,5	GC161601/2	753	773	909		
 <p>2 ante anta superiore H 72 anta inferiore H 144 2 doors upper door H 72 lower door H 144</p>	L 45 P 33	GC01345A1/2	410	445	441		
	L 60 P 33	GC01360A1/2	463	500	534		
 <p>2 ante anta superiore H 72 anta inferiore H 144 2 doors upper door H 72 lower door H 144</p>	L 30 P 59,5	GC06030A1/2	374	404	386		
	L 45 P 59,5	GC06345A1/2	319	360	475		
	L 60 P 59,5	GC06360A1/2	368	421	579		
 <p>2 ante anta superiore H 132 anta inferiore H 84 2 doors upper door H 132 lower door H 84</p>	L 45 P 33	GC01045A1/2	387	419	437		
	L 60 P 33	GC01060A1/2	462	498	534		
 <p>2 ante anta superiore H 132 anta inferiore H 84 2 doors upper door H 132 lower door H 84</p>	L 45 P 59,5	GC06045A1/2	402	434	470		
	L 60 P 59,5	GC06060A1/2	488	527	579		
	L 75 P 59,5	GC06075A1/2	661	692	703		
<p>NELLE COLONNE PER L'APERTURA DELLE ANTE E' OBBLIGATORIO L'INSERIMENTO DELLE GOLE VERTICALI VERTICAL FINGER RAILS MUST BE FITTED TO COLUMNS WITH OPENING DOORS</p>							

COLONNE H 222 CON ZOCCOLO H 6

P 59,5

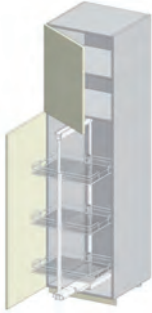
COLUMNS H 222 WITH PLINTH H 6





	COD.	NECK MELAMI- NICO KT5	NECK LACCATO KT6	NECK WOOD KT4				
 <p>portascope 2 ante anta superiore H 72 anta inferiore H 144 broom cabinet 2 doors upper door H 72 lower door H 144</p>	L 30	GC10030A1/2	274	302	380			
	L 45	GC10045A1/2	393	425	456			
 <p>portascope con ripiani 2 ante anta superiore H 72 anta inferiore H 144 broom cabinet with shelves 2 doors upper door H 72 lower door H 144</p>	L 60	GC10060A1/2	496	535	608			
 <p>1 anta superiore H 72 1 anta H 144 integrata al gruppo cestelli estraibili in filo orion grau chiusura soft 1 upper door H 72 1 door H 144 incorporated into the orion grau wire the pull-out basket units soft-closing system</p>	L 30	GC16030A1/2	620	646	722			
 <p>1 anta superiore H 72 1 anta inferiore H 144 gruppo cestelli estraibili in filo orion grau chiusura soft 1 upper door H 72 1 lower door H 144 orion grau wire pull-out basket unit soft-closing system</p>	L 45	GC16045A1/2	639	678	790			
	L 60	GC16060A1/2	720	769	919			
 <p>jolly colonna L da 15 a 30 jolly column size from 15 to 30</p>								
		EC002000	298	298	298			
		EC002030	441	—	—			
		EC005022	—	—	1.312			

colore come struttura
 same colour as carcass
melaminico come anta
 melamine same as door
impiallacciato come anta (folding)
 veneered same as door (folding)

COLONNE H 222 CON ZOCCOLO H 6

P 60



COLUMNS H 222 WITH PLINTH H 6

	COD.	NECK MELAMI- NICO KT5	NECK LACCATO KT6	NECK WOOD KT4			
 <p>angolo 5 ripiani con tirante 1 anta H 216 pannello come anta corner unit 5 shelves with tie beam 1 upper door H 216 panel as door</p>	L 110 P 60	GC306111/2	749	809	932		
	L 125 P 60	GC306261/2	773	837	1.003		
 <p>angolo 8 cestelli estraibili indipendenti all'anta 1 anta H 216 pannello come anta corner unit 8 pull-out basket units 1 door H 216 panel as door</p>	L 110 P 60	GC308111/2	1.629	1.689	1.842		
	L 125 P 60	GC308261/2	1.784	1.845	2.049		
 <p>angolo 5 ripiani con tirante 1 anta superiore H 72 1 anta inferiore H 144 pannello come anta corner unit 5 shelves with tie beam 1 upper door H 72 1 lower door H 144 panel as door</p>	L 110 P 60	GC306101/2	762	822	940		
	L 125 P 60	GC306251/2	775	837	1.014		
 <p>angolo 8 cestelli estraibili indipendenti all'anta 1 anta superiore H 72 1 anta inferiore H 144 pannello come anta corner unit 8 pull-out basket units 1 upper door H 72 1 lower door H 144 panel as door</p>	L 110 P 60	GC308101/2	1.642	1.702	1.850		
	L 125 P 60	GC308251/2	1.786	1.848	2.060		

COLONNE PER FORNO H 114 - 150 CON ZOCCOLO H 6

P 59,5

OVEN COLUMNS H 114 - 150 WITH PLINTH H 6

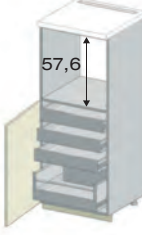
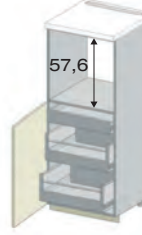
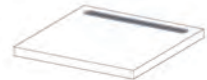



LE COLONNE NON SONO COMPRENSIVE DI TOP THE COLUMNS DO NOT INCLUDE THE TOPS		COD.	NECK MELAMI- NICO KT5	NECK LACCATO KT6	NECK WOOD KT4			
 <p>colonna H 114 per forno 1 cestone H 48 con apertura tip-on oven column H 114 1 deep drawer H 48 with opening tip-on mechanism</p>								
	L 60	GC501600	281	295	315			
 <p>colonna H 150 per forno 1 anta H 84 oven column H 150 1 door H 84</p>								
	L 60	GC520601/2	322	348	346			
 <p>*colonna H 150 per forno 1 anta H 84 3 cassetti interni 1 cestone interno *oven column H 150 1 door H 84 3 internal drawers 1 internal deep drawer</p>								
	L 60	GC521621/2	667	698	642			
 <p>*colonna H 150 per forno 1 anta H 84 1 cassetto interno 2 cestoni interni *oven column H 150 1 door H 84 1 internal drawer 2 internal deep drawers</p>								
	L 60	GC521631/2	638	669	600			
 <p>top H 1,8 come anta P 59,6 per colonne worktop H 1,8 same as door D 59,6 for columns</p>								
		melaminico al ml melamine per lm	TLE186	77	—	—		
		laccato al ml lacquered per lm	TLC196	—	96	—		
		impiallacciato al ml veneered per lm	TLH186W	—	—	136		
		mag.griglia di areazione cad. surcharge for ventilation grille each	T9FGA	30	30	30		
<p>*LE COLONNE CON CASSETTI E GESTONI INTERNI VANNO SEMPRE POSIZIONATE A 5 CM DALLA PARETE LATERALE *COLUMNS WITH INTERNAL DRAWERS AND DEEP DRAWERS SHOULD ALWAYS BE PLACED 5 CM FROM THE SIDE WALL</p>								

COLONNE PER FORNO H 222 CON ZOCCOLO H 6

P 59,5

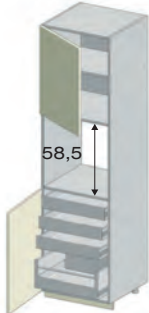
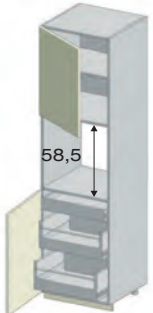
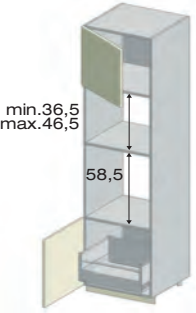
OVEN COLUMNS H 222 WITH PLINTH H 6



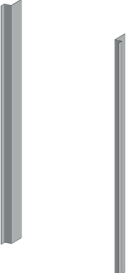

N.B.: cassetti e cestoni ad estrazione totale con blumotion
 Note: fully extending drawers and deep drawers with blumotion system

	COD.	NECK MELAMI- NICO KT5	NECK LACCATO KT6	NECK WOOD KT4			
 <p>colonna per forno 1 anta superiore H 72 1 anta inferiore H 84 oven column 1 upper door H 72 1 lower door H 84</p>	L 60	GC53060A1/2	428	454	495		
	L 75	GC53075A1/2	428	454	589		
 <p>*colonna per forno 1 anta superiore H 72 1 anta inferiore H 84 3 cassetti interni 1 cestone interno *oven column 1 upper door H 72 1 lower door H 84 3 internal drawers 1 internal deep drawer</p>	L 60	GC53162A1/2	772	818	801		
	 <p>*colonna per forno 1 anta superiore H 72 1 anta inferiore H 84 1 cassetto interno 2 cestoni interni *oven column 1 upper door H 72 1 lower door H 84 1 internal drawer 2 internal deep drawers</p>	L 60	GC53163A1/2	740	785	755	
 <p>*colonna per forno e micro apertura push-pull 1 anta superiore a misura 1 anta inferiore H 60 1 cestone interno vano micro da H 36,5 a 46,5 *oven and microwave column push-pull opening 1 upper door made to size 1 lower door H 60 1 internal deep drawer microwave compartment H 36,5 to 46,5</p>		L 60	GC551611/2	559	588	561	
	 <p>profilo in acciaio a "L" per rifinire il ripiano del forno e microonde L-shaped steel finishing profile for oven shelf and microwave</p> 	L 60	08660100	9	9	9	
 <p>kit protezione fianchi per forno protection kit sides for oven</p> 		coppia couple	08630095	16	16	16	

COLONNE PER FORNO H 222 CON ZOCCOLO H 6

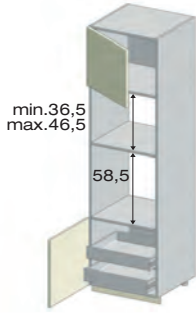
P 59,5



OVEN COLUMNS H 222 WITH PLINTH H 6

N.B.: cassetti e cestoni ad estrazione totale con blumotion Note: fully extending drawers and deep drawers with blumotion system		COD.	NECK MELAMI- NICO KT5	NECK LACCATO KT6	NECK WOOD KT4			
 <p>min.36,5 max.46,5 58,5</p> <p>*colonna per forno e micro apertura push-pull 1 anta superiore a misura 1 anta inferiore H 60 2 cassetti interni vano micro da H 36,5 a 46,5</p> <p>*oven and microwave column push-pull opening 1 upper door made to size 1 lower door H 60 2 internal drawers microwave compartment H 36,5 to 46,5</p>	L 60	GC551601/2	616	660	607			
	 <p>58,5</p> <p>colonna per forno e lavastoviglie Electrolux KESC 5300L - AEG FSE63307P 1 anta superiore H 48 1 anta lavastoviglie H 72 1 cestone H 36</p> <p>N.B.: in base alla composizione è obbligatorio inserire nella colonna con lavastoviglie, gola tipo "D" o "C" per permettere l'apertura della stessa</p> <p>column for oven and Electrolux KESC 5300L - AEG FSE63307P dishwasher 1 upper door H 48 1 dishwasher door H 72 1 deep drawer H 36</p> <p>Note: based on the composition, a type "D" or "C" finger rail must be fitted to the column with dishwasher to allow it to open</p>	L 60	GC573601/2	471	494	542		
 <p>58,7</p> <p>colonna forno sospesa H 132 per lavastoviglie 1 anta H 72</p> <p>N.B.: inserire base lavastoviglie L 60 con zoccolo H 6 della versione Bridge oppure Head con maniglia in testa</p> <p>hanging oven column H 132 for dishwasher 1 door H 72</p> <p>Note: do insert dishwasher base unit with plinth H 6 and for the Bridge version or handle applied on the top of the door for the Head version</p>	L 60	G6576601/2	268	287	320			
	 <p>fianco per colonna sospesa a fine composizione side panel for hanging column placed at the end of the composition</p> <p>H 222x59,6x1,8 zoccolo H 13 come anta same as door</p> <p>T94380 104 - 281</p> <p>H 222x59,7x1,9 zoccolo H 13 laccato come anta lacquered same as door</p> <p>T94381 - 152 -</p>							

COLONNE PER FRIGO H 150 - 222 CON ZOCCOLO H 6

P 59,5

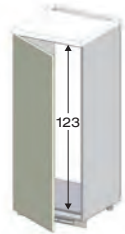
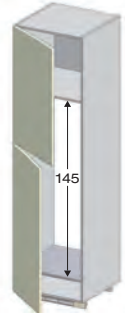
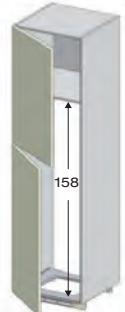
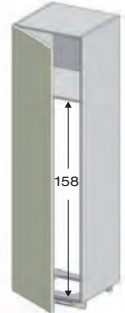



FRIDGE COLUMNS H 150 - 222 WITH PLINTH H 6



LE COLONNE NON SONO COMPRENSIVE DI TOP THE COLUMNS UNITS DO NOT INCLUDE THE TOPS		COD.	NECK MELAMI- NICO KT5	NECK LACCATO KT6	NECK WOOD KT4			
 <p>colonna H 150 per frigo 215 monoporta 1 anta H 144 column H 150 for single-door fridge 215 1 door H 144</p>	L 60	GC452151/2	335	367	418			
	 <p>colonna H 222 per frigo-freezer 230 1 anta superiore H 96 1 anta inferiore H 120 column H 222 for 230 fridge-freezer 1 upper door H 96 1 lower door H 120</p>	L 60	GC46231A1/2	421	456	533		
 <p>colonna H 222 per frigo-freezer 280 1 anta superiore H 96 1 anta inferiore H 120 column H 222 for 280 fridge-freezer 1 upper door H 96 1 lower door H 120</p>		L 60	GC46286A1/2	421	456	533		
	 <p>colonna H 222 per frigo-freezer 280 1 anta H 216 column H 222 for 280 fridge-freezer 1 upper door H 216</p>	L 60	GC462871/2	421	456	533		
 <p>colonna H 222 per frigo-congelatore 315 1 anta superiore H 132 1 anta inferiore H 84 column H 222 for 315 fridge-freezer 1 upper door H 132 1 lower door H 84</p>		L 60	GC46315A1/2	421	456	533		
	<p>NELLE COLONNE PER L'APERTURA DELLE ANTE E' OBBLIGATORIO L'INSERIMENTO DELLE GOLE VERTICALI VERTICAL FINGER RAILS MUST BE FITTED TO COLUMNS WITH OPENING DOORS</p>							

COLONNE PER FRIGO H 222 CON ZOCCOLO H 6

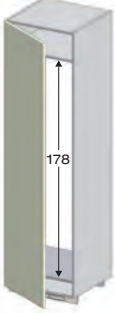
P 59,5





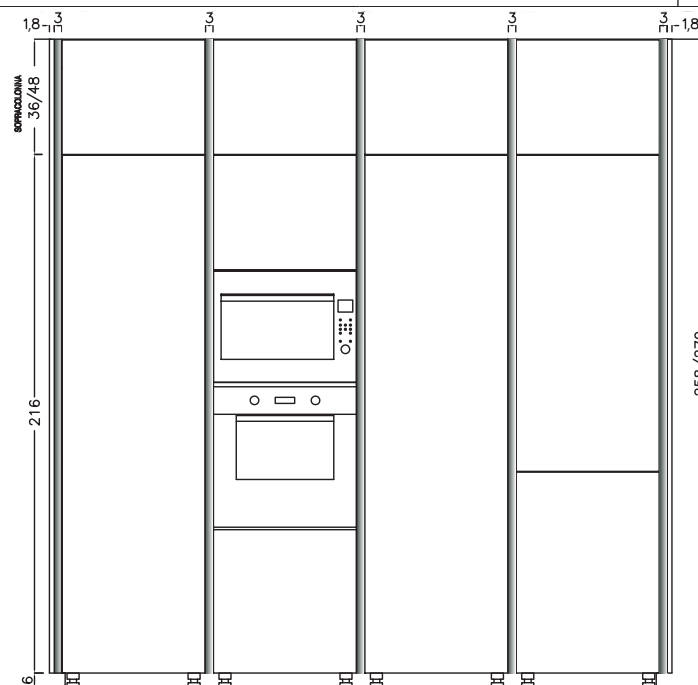

FRIDGE COLUMNS H 222 WITH PLINTH H 6

	COD.	NECK MELAMI- NICO KT5	NECK LACCATO KT6	NECK WOOD KT4				
 <p>colonna H 222 per frigo-congelatore 315 1 anta superiore H 24 1 anta centrale H 108 1 anta inferiore H 84 column H 222 for 315 fridge-freezer 1 upper door H 24 1 central door H 108 1 lower door H 84</p>	L 60	GC463161/2	458	492	553			
	 <p>colonna H 222 per frigo-congelatore 330 1 anta superiore H 132 1 anta inferiore H 84 column H 222 for 330 fridge-freezer 1 upper door H 132 1 lower door H 84</p>	L 60	GC46330A1/2	421	456	533		
 <p>colonna H 222 per frigo-congelatore 330 1 anta H 216 column H 222 for 330 fridge-freezer 1 upper door H 216</p>		L 60	GC463311/2	421	456	533		
	 <p>colonna H 222 per frigo-freezer 300 monoporta 1 anta H 216 column H 222 for 300 single-door fridge-freezer 1 door H 216</p>	L 60	GC463001/2	421	456	533		
 <p>colonna H 222 per frigo-congelatore 350 1 anta superiore H 132 1 anta inferiore H 84 column H 222 for 350 fridge-freezer 1 upper door H 132 1 lower door H 84</p>		L 60	GC46350A1/2	421	456	533		
	 <p>colonna H 222 per frigo-congelatore 400 1 anta superiore H 132 1 anta inferiore H 84 column H 222 for 400 fridge-freezer 1 upper door H 132 1 lower door H 84</p>	L 75	GC46400A1/2	615	647	655		





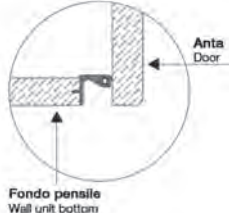

		COD.	NECK MELAMI- NICO KT5	NECK LACCATO KT6	NECK WOOD KT4				
 <p>sopracolonna 1 anta top column 1 door</p>	H 36 L 30	GC601301/2	134	135	145				
	L 45	GC601451/2	131	140	151				
	L 60	GC601601/2	145	156	169				
	ribalta TIP-ON L 75	GC61076T	230	246	272				
	H 48 L 30	GC602301/2	168	171	171				
	L 45	GC602451/2	170	180	182				
	L 60	GC602601/2	187	200	207				
	ribalta TIP-ON L 75	GC61276T	275	295	319				
	 <p>sopracolonna 1 anta vetro top column 1 glass door</p>	telaio alluminio H 36 L 45	GC605461/2	208	208	208			
		L 60	GC605611/2	231	231	231			
H 48 L 45		GC606461/2	236	236	236				
L 60		GC606611/2	291	291	291				
telaio melaminico H 36 L 45		GC605451/2	233	—	—				
L 60		GC605601/2	264	—	—				
H 48 L 45		GC606451/2	263	—	—				
L 60		GC606601/2	326	—	—				
 <p>gola verticale e fianco per colonna vertical finger rail and side panel for column</p>	gola verticale ELLE tipo "C" al ml ELLE vertical finger rail type "C" per lm								
	H 252	G950390	152	152	152				
	H 264	G950390	160	160	160				
	gola verticale ELLE tipo "D" al ml ELLE vertical finger rail type "D" per lm								
	H 252	G950490	152	152	152				
	H 264	G950490	160	160	160				
	fianco side panel								
	H 251,7x59,6x1,8	T94390	120	—	317				
	H 263,7x59,6x1,8	T94392	180	—	330				
	H 251,7x59,7x1,9	T94391	—	176	—				
H 263,7x59,7x1,9	T94393	—	235	—					









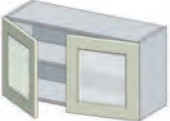

N.B.: cerniere ammortizzate di serie
Note: standard blumotion hinges





			BRIDGE MELAMI- NICO KT1	BRIDGE LACCATO KT2	BRIDGE WOOD KT0	HEAD MELAMI- NICO KT8	HEAD LACCATO KT9	HEAD WOOD KT7	
 <p>1 anta H 36 1 door H 36</p>	L 45	E2030451/2	76	82	106	89	97	124	
	L 60	E2030601/2	82	91	121	99	109	143	
	L 65	E2030651/2	93	99	128	104	114	147	
 <p>1 anta H 48 1 door H 48</p>	L 45	E2040451/2	90	99	128	103	113	145	
	L 60	E2040601/2	99	111	148	116	128	170	
	L 65	E2040651/2	104	118	157	121	135	176	
 <p>1 anta H 60 1 door H 60</p>	L 45	E2060451/2	96	108	140	110	122	157	
	L 60	E2060601/2	107	122	177	124	140	185	
 <p>1 anta H 72 1 door H 72</p>	L 15	E2010151/2	80	88	106	89	95	112	
	L 30	E2010301/2	88	97	126	99	109	138	
	L 40	E2010401/2	96	108	145	109	122	161	
	L 45	E2010451/2	99	113	153	113	127	171	
	L 60	E2010601/2	111	129	181	128	146	203	
	L 65	E2010651/2	116	134	190	133	153	209	
 <p>1 anta H 96 1 door H 96</p>	L 15	E2020151/2	93	103	124	102	110	130	
	L 30	E2020301/2	105	118	153	116	129	164	
	L 40	E2020401/2	115	131	178	129	145	194	
	L 45	E2020451/2	120	136	190	134	151	207	
	L 60	E2020601/2	139	163	230	156	180	252	
	L 65	E2020651/2	145	170	242	163	189	261	
 <p>1 anta H 108 1 door H 108</p>	L 30	E2144301/2	128	143	175	139	155	186	
	L 45	E2144451/2	141	164	214	159	182	232	
	L 60	E2144601/2	159	187	254	181	208	276	
	L 65	E2144651/2	164	196	268	186	218	287	
 <p>1 anta H 120 1 door H 120</p>	L 30	E2145301/2	168	183	218	179	195	229	
	L 45	E2145451/2	185	207	260	199	222	278	
	L 60	E2145601/2	205	234	303	222	252	324	
 <p>Maggiorazione per apertura senza maniglia Surcharge for opening without handle</p> <p>Anta Door Fondo pensile Wall unit bottom</p>									
		Presu su fondo (Opz.997) Grip on bottom opening (code 997)	+ 10	+ 10	+ 10	-	-	-	
		Push Pull (Opz.996) 1 anta Push Pull (code 996) 1 door	+ 10	+ 10	+ 10	-	-	-	
		Push Pull (Opz.996) 2 ante Push Pull (code 996) 2 doors	+ 20	+ 20	+ 20	-	-	-	

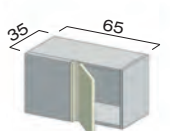
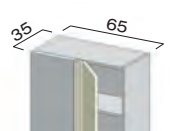
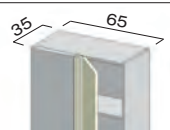

N.B.: cerniere ammortizzate di serie Note: standard blumotion hinges		COD.	BRIDGE MELAMI- NICO KT1	BRIDGE LACCATO KT2	BRIDGE WOOD KT0	HEAD MELAMI- NICO KT8	HEAD LACCATO KT9	HEAD WOOD KT7	
 <p>2 ante H 36 2 doors H 36</p>	L 90	E2030900	144	136	178	150	166	213	
	L 90	E2040900	144	163	216	172	192	251	
 <p>2 ante H 48 2 doors H 48</p>	L 90	E2060900	154	177	251	182	206	273	
	L 60	E2010600	136	155	209	159	179	231	
 <p>2 ante H 72 2 doors H 72</p>	L 80	E2010800	153	178	246	180	205	279	
	L 90	E2010900	160	188	264	188	217	299	
	L 60	E2020600	162	187	255	185	211	277	
 <p>2 ante H 96 2 doors H 96</p>	L 80	E2020800	183	215	304	210	243	337	
	L 90	E2020900	192	225	327	221	254	362	
	L 90	E2144900	218	263	367	253	298	402	
 <p>cestello estraibile chiusura soft pull-out basket unit soft-closing system</p>	H 72 L 15	E2010150	130	136	144	143	149	150	
	H 96 L 15	E2020150	157	165	176	170	178	182	
	H 108 L 15	E2144150	156	165	181	166	175	191	
 <p>fascia tamponamento L da 3 a 15 N.B.: la fascia è realizzata senza maniglia per la versione Head filler panel size from 3 to 15 Note: panel realized without handle for Head version</p>	H 60	E2790000	59	64	79	59	64	79	
	H 72	E2800000	59	64	83	59	64	83	
	H 96	E2810000	71	81	95	71	81	95	
	H 108	E2810800	80	91	109	80	91	109	
	H 120	E2810805	88	96	115	88	96	115	

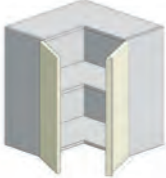
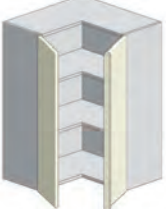
N.B.: cerniere ammortizzate di serie Note: standard blumotion hinges		COD.	BRIDGE	BRIDGE	BRIDGE	HEAD	HEAD	HEAD	
			MELAMI- NICO KT1	LACCATO KT2	WOOD KT0	MELAMI- NICO KT8	LACCATO KT9	WOOD KT7	
 <p>1 anta vetro H 36 1 glass door H 36</p>	telaio alluminio L 45 aluminium frame	G1032451/2	161	161	161	161	161	161	
	L 60	G1032601/2	177	177	177	177	177	177	
	telaio melaminico L 45 melamine frame	G1030451/2	201	—	—	201	—	—	
	L 60	G1030601/2	226	—	—	226	—	—	
 <p>1 anta vetro H 48 1 glass door H 48</p>	telaio alluminio L 45 aluminium frame	G1042451/2	182	182	182	182	182	182	
	L 60	G1042601/2	202	202	202	202	202	202	
	telaio melaminico L 45 melamine frame	G1040451/2	225	—	—	225	—	—	
	L 60	G1040601/2	254	—	—	254	—	—	
 <p>1 anta vetro H 60 1 glass door H 60</p>	telaio alluminio L 60 aluminium frame	G1062601/2	220	220	220	220	220	220	
	telaio melaminico L 60 melamine frame	G1060601/2	261	—	—	261	—	—	
 <p>1 anta vetro H 72 1 glass door H 72</p>	telaio alluminio L 45 aluminium frame	G1012451/2	207	207	207	207	207	207	
	L 60	G1012601/2	231	231	231	231	231	231	
	telaio melaminico L 45 melamine frame	G1010451/2	255	—	—	255	—	—	
	L 60	G1010601/2	275	—	—	275	—	—	
 <p>1 anta vetro H 96 1 glass door H 96</p>	telaio alluminio L 45 aluminium frame	G1022451/2	250	250	250	250	250	250	
	L 60	G1022601/2	289	289	289	289	289	289	
	telaio melaminico L 45 melamine frame	G1020451/2	274	—	—	274	—	—	
	L 60	G1020601/2	329	—	—	329	—	—	
 <p>terminale H 72 31x31 a giorno tipo "A" open end unit H 72 31x31 type "A"</p> <p>H 72</p>	H 72								
	colore come struttura same colour as carcass	E2620310	82	82	82	82	82	82	
 <p>terminale H 96 31x31 a giorno tipo "A" open end unit H 96 31x31 type "A"</p> <p>H 96</p>	H 96								
	colore come struttura same colour as carcass	E2630310	99	99	99	99	99	99	

N.B.: cerniere ammortizzate di serie Note: standard blumotion hinges		COD.	BRIDGE	BRIDGE	BRIDGE	HEAD	HEAD	HEAD	
			MELAMI- NICO KT1	LACCATO KT2	WOOD KT0	MELAMI- NICO KT8	LACCATO KT9	WOOD KT7	
 <p>2 ante vetro H 36 2 glass doors H 36</p>	<p>telaio alluminio L 90 aluminium frame</p> <p>telaio melaminico L 90 melamine frame</p>								
		G1032900	285	285	285	285	285	285	
		G1030900	364	—	—	364	—	—	
 <p>2 ante vetro H 48 2 glass doors H 48</p>	<p>telaio alluminio L 90 aluminium frame</p> <p>telaio melaminico L 90 melamine frame</p>								
		G1042900	321	321	321	321	321	321	
		G1040900	403	—	—	403	—	—	
 <p>2 ante vetro H 72 2 glass doors H 72</p>	<p>telaio alluminio L 90 aluminium frame</p> <p>telaio melaminico L 90 melamine frame</p>								
		G1012900	370	370	370	370	370	370	
		G1010900	467	—	—	467	—	—	
 <p>2 ante vetro H 96 2 glass doors H 96</p>	<p>telaio alluminio L 90 aluminium frame</p> <p>telaio melaminico L 90 melamine frame</p>								
		G1022900	446	446	446	446	446	446	
		G1020900	496	—	—	496	—	—	
 <p>jolly pensile H 72 L da 10 a 30 jolly wall unit H 72 size from 10 to 30</p>	<p>colore come struttura same colour as carcass</p> <p>melaminico come anta melamine same as door</p> <p>impiallacciato come anta (folding) veneered same as door (folding)</p>								
		E2700000	115	115	115	115	115	115	
		E2700030	144	—	—	144	—	—	
		G2707220	—	—	360	—	—	360	
 <p>jolly pensile H 96 L da 10 a 30 jolly wall unit H 96 size from 10 to 30</p>	<p>colore come struttura same colour as carcass</p> <p>melaminico come anta melamine same as door</p> <p>impiallacciato come anta (folding) veneered same as door (folding)</p>								
		E2710000	140	140	140	140	140	140	
		E2710030	180	—	—	180	—	—	
		G2709620	—	—	443	—	—	443	
 <p>jolly pensile H 108 L da 10 a 30 jolly wall unit H 108 size from 10 to 30</p>	<p>colore come struttura same colour as carcass</p> <p>melaminico come anta melamine same as door</p> <p>impiallacciato come anta (folding) veneered same as door (folding)</p>								
		E2710800	150	150	150	150	150	150	
		E2710830	217	—	—	217	—	—	
		G2710820	—	—	471	—	—	471	

N.B.: cerniere ammortizzate di serie Note: standard blumotion hinges		COD.	BRIDGE MELAMI- NICO KT1	BRIDGE LACCATO KT2	BRIDGE WOOD KT0	HEAD MELAMI- NICO KT8	HEAD LACCATO KT9	HEAD WOOD KT7	
	angolo H 36 2 ante a libretto N.B.: fuori squadra realizzabili da 88° a 92° Per la versione Head viene realizzato solo con la maniglia 920T corner unit H 36 2 folding doors Note: out-of-plumb units available from 88° to 92° Only realized with handle 920T for Head version	65X65	E2445651/2	207	212	227	214	234	285
	angolo H 72 2 ante a libretto N.B.: fuori squadra realizzabili da 88° a 92° Per la versione Head viene realizzato solo con la maniglia 920T corner unit H 72 2 folding doors Note: out-of-plumb units available from 88° to 92° Only realized with handle 920T for Head version	65X65	E2450651/2	214	235	306	247	249	346
	angolo H 96 2 ante a libretto N.B.: fuori squadra realizzabili da 88° a 92° Per la versione Head viene realizzato solo con la maniglia 920T corner unit H 96 2 folding doors Note: out-of-plumb units available from 88° to 92° Only realized with handle 920T for Head version	65X65	E2460651/2	269	296	376	302	310	417
	angolo H 108 2 ante a libretto N.B.: fuori squadra realizzabili da 88° a 92° Per la versione Head viene realizzato solo con la maniglia 920T corner unit H 108 2 folding doors Note: out-of-plumb units available from 88° to 92° Only realized with handle 920T for Head version	65X65	E2463651/2	308	320	337	318	334	448
	angolo H 36 1 anta N.B.: fuori squadra realizzabili da 88° a 94° corner unit H 36 1 door Note: out-of-plumb units available from 88° to 94°	65X35	E2490651/2	167	183	220	201	208	237
	angolo H 72 1 anta N.B.: fuori squadra realizzabili da 88° a 94° corner unit H 72 1 door Note: out-of-plumb units available from 88° to 94°	65X35	E2491651/2	167	183	267	188	203	298
	angolo H 96 1 anta N.B.: fuori squadra realizzabili da 88° a 94° corner unit H 96 1 door Note: out-of-plumb units available from 88° to 94°	65X35	E2495651/2	204	224	330	224	245	362
	angolo H 108 1 anta N.B.: fuori squadra realizzabili da 88° a 94° corner unit H 108 1 door Note: out-of-plumb units available from 88° to 94°	65X35	E2497651/2	310	341	401	317	328	414

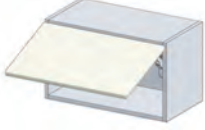

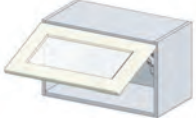
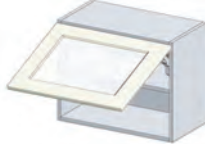
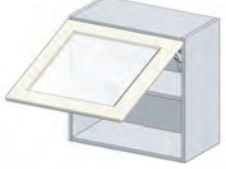
N.B.: cerniere ammortizzate di serie Note: standard blumotion hinges		COD.	BRIDGE	BRIDGE	BRIDGE	HEAD	HEAD	HEAD	
			MELAMI- NICO KT1	LACCATO KT2	WOOD KT0	MELAMI- NICO KT8	LACCATO KT9	WOOD KT7	
 <p>angolo H 72 2 ante (anta sx+dx con angolare) N.B.: non si effettuano fuori squadra Per la versione Head viene realizzato solo con la maniglia 910 e 913 corner unit H 72 2 doors (LH+RH door with angular) Note: out-of-plumb units unavailable Only realized with handle 910 and 913 for Head version</p>	65X65	E2430650	—	—	—	258	288	313	
	65X65	E2440650	—	—	—	303	342	373	
 <p>angolo H 96 2 ante (anta sx+dx con angolare) N.B.: non si effettuano fuori squadra Per la versione Head viene realizzato solo con la maniglia 910 e 913 corner unit H 96 2 doors (LH+RH door with angular) Note: out-of-plumb units unavailable Only realized with handle 910 and 913 for Head version</p>	65X65	E2400651/2	170	184	227	185	199	244	
	65X65	E2410651/2	202	219	275	217	233	292	
 <p>copriboiler H 72 1 anta boiler housing H 72 1 door</p>	L 60 P 33	E2150601/2	99	118	177	117	137	201	
	L 60 P 47	E2160601/2	145	176	210	175	196	235	
	L 60 P 59,5	E2170601/2	145	176	210	175	196	235	
 <p>copriboiler H 96 1 anta boiler housing H 96 1 door</p>	L 60 P 33	E2210601/2	114	139	216	133	158	239	
	L 60 P 47	E2220601/2	171	208	280	201	228	304	
	L 60 P 59,5	E2230601/2	171	208	280	201	228	304	
 <p>copriboiler H 108 1 anta boiler housing H 108 1 door</p>	L 60 P 33	E2250601/2	147	176	248	170	199	271	
	L 60 P 47	E2260601/2	198	229	308	222	253	333	
	L 60 P 59,5	E2270601/2	198	229	308	222	253	333	

		COD.	BRIDGE MELAMI- NICO KT1	BRIDGE LACCATO KT2	BRIDGE WOOD KT0	HEAD MELAMI- NICO KT8	HEAD LACCATO KT9	HEAD WOOD KT7	
 <p>anta ribalta H 36 flap door H 36</p>	L 45	E2100450	102	109	142	117	124	160	
	L 60	E2100600	105	115	152	123	133	174	
	L 65	E2100650	117	125	158	134	143	177	
	L 90	E2100900	136	150	200	160	174	223	
	L 120	E2101200	180	198	—	185	203	—	
	 <p>anta ribalta H 48 flap door H 48</p>								
L 45	E2120450	116	126	163	136	143	182		
L 60	E2120600	138	150	196	155	168	218		
L 65	E2120650	149	161	205	166	179	224		
L 90	E2120900	158	176	227	182	200	260		
L 120	E212120C	238	265	—	243	270	—		
 <p>anta ribalta H 60 flap door H 60</p>	L 60	E212560C	191	207	263	209	229	284	
	L 90	E212590C	238	261	336	262	285	358	
	 <p>anta vetro ribalta H 36 N.B.: apertura senza maniglia, presa su fondo glass flap door H 36 Note: opening without handle, grip on bottom</p>								
telaio alluminio L 45 aluminium frame	L 45	G1102450	186	186	186	186	186	186	
L 60	G1102600	202	202	202	202	202	202		
L 90	G1102900	255	255	255	255	255	255		
 <p>anta vetro ribalta H 48 N.B.: apertura senza maniglia, presa su fondo glass flap door H 48 Note: opening without handle, grip on bottom</p>	telaio alluminio L 45 aluminium frame	L 45	G1122450	229	229	229	229	229	
	L 60	G1122600	283	283	283	283	283	283	
	L 90	G1122900	323	323	323	323	323	323	
	 <p>anta vetro ribalta H 60 N.B.: apertura senza maniglia, presa su fondo glass flap door H 60 Note: opening without handle, grip on bottom</p>								
telaio alluminio L 60 aluminium frame	L 60	G1132600	299	299	299	299	299	299	
L 90	G1132900	368	368	368	368	368	368		



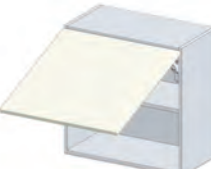

Grazie al meccanismo TIP-ON, le ante a ribalta senza maniglia possono essere aperte semplicemente con un leggero tocco. Per chiudere l'anta a ribalta, è sufficiente esercitare una leggera pressione, che grazie ad una piastrina di bloccaggio, applicata sul lato interno del frontale, ne assicura la perfetta chiusura.

Thanks to TIP-ON mechanism, the flap doors without handles can be opened with a simple touch. To close the flap door, just exercise light pressure, thanks to the locking plate, applied on the inner side of the front panel ensures a perfect closure.

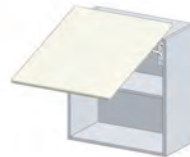
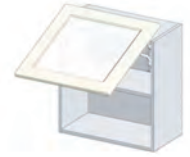
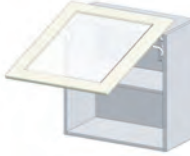
	COD.	BRIDGE MELAMI- NICO KT1	BRIDGE LACCATO KT2	BRIDGE WOOD KT0	HEAD MELAMI- NICO KT8	HEAD LACCATO KT9	HEAD WOOD KT7	
anta ribalta TIP-ON H 36 flap door TIP-ON H 36 	L 45	E210046T	111	119	154	111	119	163
	L 60	E210061T	114	124	165	114	124	174
	L 65	E210066T	120	128	170	120	128	179
	L 90	E210091T	153	167	223	153	167	232
	L 120	E210121T	213	231	—	222	240	—
anta ribalta TIP-ON H 48 flap door TIP-ON H 48 	L 45	E212046T	125	135	176	125	135	185
	L 60	E212061T	154	167	219	154	167	228
	L 65	E212066T	159	172	228	159	172	237
	L 90	E212091T	174	193	260	174	193	269
	L 120	E212121T	263	289	—	272	298	—
anta ribalta TIP-ON H 60 flap door TIP-ON H 60 	L 60	E212561T	196	212	270	196	212	288
	L 90	E212591T	243	266	346	243	266	368

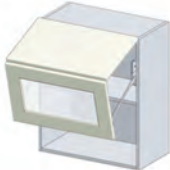
	COD.	BRIDGE MELAMI- NICO KT1	BRIDGE LACCATO KT2	BRIDGE WOOD KT0	HEAD MELAMI- NICO KT8	HEAD LACCATO KT9	HEAD WOOD KT7	
<p>anta apertura verticale obliqua H 60 door with oblique vertical opening H 60</p> 	L 60	E2135600	254	269	309	272	287	331
	L 90	E2135900	283	305	364	307	329	387
<p>anta apertura verticale obliqua H 72 door with oblique vertical opening H 72</p> 	L 60	E2130600	264	282	332	282	300	354
	L 65	E2130650	274	288	341	286	306	360
	L 90	E2130900	289	316	389	313	340	412
<p>anta vetro apertura verticale obliqua H 60 N.B.: apertura senza maniglia, presa su fondo glass door with oblique vertical opening H 60 Note: opening without handle, grip on bottom</p> 	telaio alluminio L 60 aluminium frame	G1207600	384	384	384	384	384	384
	L 90	G1207900	437	437	437	437	437	437
	telaio melaminico L 60 melamine frame	G1205600	419	—	—	419	—	—
	L 90	G1205900	476	—	—	476	—	—
<p>anta vetro apertura verticale obliqua H 72 N.B.: apertura senza maniglia, presa su fondo glass door with oblique vertical opening H 72 Note: opening without handle, grip on bottom</p> 	telaio alluminio L 60 aluminium frame	G1202600	402	402	402	402	402	402
	L 90	G1202900	453	453	453	453	453	453
	telaio melaminico L 60 melamine frame	G1200600	438	—	—	438	—	—
	L 90	G1200900	514	—	—	514	—	—

	COD.	BRIDGE MELAMI- NICO KT1	BRIDGE LACCATO KT2	BRIDGE WOOD KT0	HEAD MELAMI- NICO KT8	HEAD LACCATO KT9	HEAD WOOD KT7	
<p>pensile H 72 apertura a pacchetto 2 ante H 36 wall unit H 72 lift-up folding door 2 doors H 36</p> 	L 45	E2070450	277	291	326	299	315	344
	L 60	E2070600	287	307	355	314	334	385
	L 65	E2070650	291	312	364	319	340	392
	L 90	E2070900	316	345	415	349	378	438
	L 120	E2071200	376	411	—	380	425	—
	<p>pensile H 72 apertura a pacchetto 1 anta chiusa superiore H 36 1 anta vetro inferiore H 36 N.B.: apertura senza maniglia, presa su fondo wall unit H 72 lift-up folding door 1 full upper door H 36 1 glass lower door H 36 Note: opening without handle, grip on bottom</p> 	telaio alluminio L 45 aluminium frame	G2085450	379	387	379	379	387
L 60		G2085600	400	405	400	400	405	400
L 90		G2085900	449	458	449	449	458	449
<p>pensile H 96 apertura a pacchetto 2 ante H 48 wall unit H 96 lift-up folding door 2 doors H 48</p> 		L 45	E2090450	305	324	370	327	350
	L 60	E2090600	318	344	407	345	370	429
	L 65	E2090650	324	351	420	351	382	448
	L 90	E2090900	355	392	487	382	418	508
	<p>pensile H 96 apertura a pacchetto 1 anta chiusa superiore H 48 1 anta vetro inferiore H 48 N.B.: apertura senza maniglia, presa su fondo wall unit H 96 lift-up folding door 1 full upper door H 48 1 glass lower door H 48 Note: opening without handle, grip on bottom</p> 	telaio alluminio L 60 aluminium frame	G2097600	428	441	428	428	441
L 90		G2097900	486	505	486	486	505	486

N.B.: cerniere ammortizzate di serie
Note: standard blumotion hinges

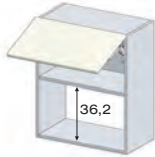
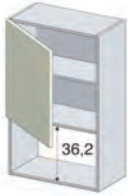
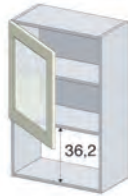
	COD.	BRIDGE MELAMI- NICO KT1	BRIDGE LACCATO KT2	BRIDGE WOOD KT0	HEAD MELAMI- NICO KT8	HEAD LACCATO KT9	HEAD WOOD KT7	
<p>pensile H 72 1 anta ribalta H 36 vano per micro Whirlpool wall unit H 72 1 flap door H 36 housing for Whirlpool microwave</p> 								
	L 60 EPM20600	137	147	179	155	165	200	
<p>pensile H 96 1 anta H 60 vano per micro Whirlpool wall unit H 96 1 door H 60 housing for Whirlpool microwave</p> 								
	L 60 EPM25601/2	140	155	198	157	172	219	
<p>pensile H 96 1 anta vetro H 60 apertura push-pull vano per micro Whirlpool wall unit H 96 1 glass door H 60 push-pull opening housing for Whirlpool microwave</p> 								
	telaio alluminio L 60 aluminium frame GPM16601/2	234	234	234	234	234	234	

nella versione Bridge scolapiatti realizzabili anche con apertura senza maniglia, presa sul fondo (opz.997) plate-rack units are feasible also without handle, grip on bottom opening (opt. 997) for Bridge version		COD.	BRIDGE MELAMI- NICO KT1	BRIDGE LACCATO KT2	BRIDGE WOOD KT0	HEAD MELAMI- NICO KT8	HEAD LACCATO KT9	HEAD WOOD KT7	
 1 anta H 60 1 door H 60	L 60	E3060601/2	127	143	194	145	160	216	
	 1 anta H 72 1 door H 72	L 45	E3010451/2	120	134	185	134	149	202
L 60		E3010601/2	130	149	212	148	167	234	
L 65		E3010651/2	158	178	228	177	196	247	
 1 anta H 96 1 door H 96	L 45	E3020451/2	141	157	221	155	172	239	
	L 60	E3020601/2	163	187	265	181	205	287	
	L 65	E3020651/2	188	214	276	207	233	299	
 1 anta H 108 1 door H 108	L 45	E3066451/2	177	200	250	194	217	267	
	L 60	E3066601/2	194	222	289	216	243	311	
	L 65	E3066651/2	199	231	304	222	253	323	
 1 anta H 120 1 door H 120	L 45	E3067451/2	200	222	296	214	237	313	
	L 60	E3067601/2	216	246	337	234	263	359	
 1 anta vetro H 60 N.B.: anta senza maniglia 1 glass door H 60 Note: door without handle	telaio alluminio L 60 aluminium frame	G3262601/2	228	228	228	228	228	228	
	telaio melaminico L 60 melamine frame	G3260601/2	266	—	—	266	—	—	
 1 anta vetro H 72 N.B.: anta senza maniglia 1 glass door H 72 Note: door without handle	telaio alluminio L 45 aluminium frame	G3212451/2	218	218	218	218	218	218	
	L 60	G3212601/2	240	240	240	240	240	240	
	telaio melaminico L 45 melamine frame	G3210451/2	266	—	—	266	—	—	
	L 60	G3210601/2	283	—	—	283	—	—	
 1 anta vetro H 96 N.B.: anta senza maniglia 1 glass door H 96 Note: door without handle	telaio alluminio L 45 aluminium frame	G3222451/2	261	261	261	261	261	261	
	L 60	G3222601/2	293	293	293	293	293	293	
	telaio melaminico L 45 melamine frame	G3220451/2	285	—	—	285	—	—	
	L 60	G3220601/2	334	—	—	334	—	—	





nella versione Bridge scolapiatti realizzabili anche con apertura senza maniglia, presa sul fondo (opz.997) plate-rack units are feasible also without handle, grip on bottom opening (opt. 997) for Bridge version		COD.	BRIDGE MELAMI- NICO KT1	BRIDGE LACCATO KT2	BRIDGE WOOD KT0	HEAD MELAMI- NICO KT8	HEAD LACCATO KT9	HEAD WOOD KT7	
 <p>2 ante H 60 2 doors H 60</p>	L 90	E3060900	182	207	283	212	236	318	
	L 80	E3010800	182	208	288	210	236	322	
 <p>2 ante H 72 2 doors H 72</p>	L 90	E3010900	190	219	308	220	249	343	
	L 80	E3020800	211	245	345	239	272	379	
 <p>2 ante H 96 2 doors H 96</p>	L 90	E3020900	222	255	370	251	284	405	
	L 80	E3066900	268	314	418	303	349	453	
 <p>2 ante vetro H 72 N.B.: ante senza maniglia 2 glass doors H 72 Note: doors without handle</p>	telaio alluminio L 90 aluminium frame	G3212900	388	388	388	388	388	388	
	telaio melaminico L 90 melamine frame	G3210900	485	—	—	485	—	—	
	L 90	E3066900	268	314	418	303	349	453	
 <p>2 ante vetro H 96 N.B.: ante senza maniglia 2 glass doors H 96 Note: doors without handle</p>	telaio alluminio L 90 aluminium frame	G3222900	462	462	462	462	462	462	
	telaio melaminico L 90 melamine frame	G3220900	512	—	—	512	—	—	
	L 90	E3066900	268	314	418	303	349	453	





nella versione Bridge scolapiatti realizzabili anche con apertura senza maniglia, presa sul fondo (opz.997) plate-rack units are feasible also without handle, grip on bottom opening (opt. 997) for Bridge version		COD.	BRIDGE MELAMI- NICO KT1	BRIDGE LACCATO KT2	BRIDGE WOOD KT0	HEAD MELAMI- NICO KT8	HEAD LACCATO KT9	HEAD WOOD KT7
 <p>angolo H 72 2 ante a libretto N.B.: non si effettuano fuori squadra Per la versione Head viene realizzato solo con la maniglia 920T corner unit H 72 2 folding doors Note: out-of-plumb units unavailable Only realized with handle 920T for Head version</p>	65X65	E3450651/2	366	387	464	399	420	477
	65X65	E3460651/2	427	454	544	459	487	557
 <p>angolo H 72 2 ante anta sx+dx con angolare N.B.: non si effettuano fuori squadra Per la versione Head viene realizzato solo con la maniglia 910 e 913 corner unit H 72 2 doors LH+RH door with angular Note: out-of-plumb units unavailable Only realized with handle 910 and 913 for Head version</p>	65X65	E3430650	—	—	—	410	440	475
	65X65	E3440650	—	—	—	461	500	540
 <p>angolo H 96 2 ante anta sx+dx con angolare N.B.: non si effettuano fuori squadra Per la versione Head viene realizzato solo con la maniglia 910 e 913 corner unit H 96 2 doors LH+RH door with angular Note: out-of-plumb units unavailable Only realized with handle 910 and 913 for Head version</p>								
		opz.005						
	L 45		+100	+100	+100	+100	+100	+100
	L 60		+105	+105	+105	+105	+105	+105
	L 65		+105	+105	+105	+105	+105	+105
	L 80		+115	+115	+115	+115	+115	+115
	L 90		+115	+115	+115	+115	+115	+115
L 120		+135	+135	+135	+135	+135	+135	

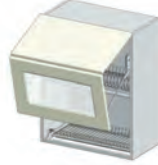

Maggiorazione
kit luce LED DUAL COLOR calda (2700K) e naturale (4200K)
interruttore ON/OFF "Touch" a sfioramento con alimentatore incluso
Surcharge
DUAL COLOR LED light kit warm (2700K) and natural (4200K)
"Soft Touch" switch ON/OFF with power supplier

	COD.	BRIDGE MELAMI- NICO KT1	BRIDGE LACCATO KT2	BRIDGE WOOD KT0	HEAD MELAMI- NICO KT8	HEAD LACCATO KT9	HEAD WOOD KT7	
 <p>anta ribalta H 36 griglie orion grau e raccogliocce plastica flap door H 36 orion grau grilles and plastic drip tray</p>								
	L 60	E3100600	127	138	177	139	149	199
	L 90	E3100900	160	175	235	182	196	257
	L 120	E3101205	237	255	—	242	260	—
 <p>anta ribalta H 48 griglie orion grau e raccogliocce plastica flap door H 48 orion grau grilles and plastic drip tray</p>								
	L 60	E3120600	145	157	212	161	174	234
	L 90	E3120900	179	186	259	191	209	282
	L 120	E3121205	280	306	—	285	311	—
 <p>anta ribalta H 60 griglie orion grau e raccogliocce plastica flap door H 60 orion grau grilles and plastic drip tray</p>								
	L 60	E312260C	202	218	286	221	236	308
	L 90	E312290C	252	276	365	277	300	388
 <p>anta vetro ribalta H 36 griglie orion grau e raccogliocce plastica N.B.: anta senza maniglia glass flap door H 36 orion grau grilles and plastic drip tray Note: door without handle</p>								
	telaio alluminio L 60 aluminium frame	G3132600	243	243	243	243	243	243
	L 90	G3132900	271	271	271	271	271	271
 <p>anta vetro ribalta H 48 griglie orion grau e raccogliocce plastica N.B.: anta senza maniglia glass flap door H 48 orion grau grilles and plastic drip tray Note: door without handle</p>								
	telaio alluminio L 60 aluminium frame	G3142600	282	282	282	282	282	282
	L 90	G3142900	323	323	323	323	323	323
 <p>anta vetro ribalta H 60 griglie orion grau e raccogliocce plastica N.B.: anta senza maniglia glass flap door H 60 orion grau grilles and plastic drip tray Note: door without handle</p>								
	telaio alluminio L 60 aluminium frame	G3152600	359	359	359	359	359	359
	L 90	G3152900	462	462	462	462	462	462

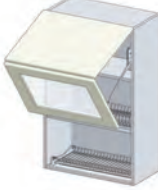

	COD.	BRIDGE MELAMI- NICO KT1	BRIDGE LACCATO KT2	BRIDGE WOOD KT0	HEAD MELAMI- NICO KT8	HEAD LACCATO KT9	HEAD WOOD KT7	
 <p>anta apertura verticale obliqua H 60 griglie orion grau e raccogliocce plastica door with vertical oblique opening H 60 orion grau grilles and plastic drip tray</p>	L 60	E3123600	266	282	331	284	300	353
	L 90	E3123900	298	322	392	323	345	414
	 <p>anta apertura verticale obliqua H 72 griglie orion grau e raccogliocce plastica door with vertical oblique opening H 72 orion grau grilles and plastic drip tray</p>	L 60	E3125600	276	294	354	293	312
L 90		E3125900	303	331	417	328	355	439
 <p>anta vetro apertura verticale obliqua H 60 griglie orion grau e raccogliocce plastica N.B.: anta senza maniglia glass door with vertical oblique opening H 60 orion grau grilles and plastic drip tray Note: door without handle</p>		telaio alluminio L 60 aluminium frame	G3207600	379	379	379	379	379
	L 90	G3207900	432	432	432	432	432	432
	telaio melaminico L 60 melamine frame	G3205600	414	—	—	414	—	—
	L 90	G3205900	472	—	—	472	—	—
	 <p>anta vetro apertura verticale obliqua H 72 griglie orion grau e raccogliocce plastica N.B.: anta senza maniglia glass door with vertical oblique opening H 72 orion grau grilles and plastic drip tray Note: door without handle</p>	telaio alluminio L 60 aluminium frame	G3202600	397	397	397	397	397
L 90		G3202900	447	447	447	447	447	447
telaio melaminico L 60 melamine frame		G3200600	433	—	—	433	—	—
L 90		G3200900	508	—	—	508	—	—
 <p>Maggiorazione kit luce LED DUAL COLOR calda (2700K) e naturale (4200K) interruttore ON/OFF "Touch" a sfioramento con alimentatore incluso Surcharge DUAL COLOR LED light kit warm (2700K) and natural (4200K) "Soft Touch" switch ON/OFF with power supplier</p>		opz.005						
	L 45		+100	+100	+100	+100	+100	+100
	L 60		+105	+105	+105	+105	+105	+105
	L 65		+105	+105	+105	+105	+105	+105
	L 80		+115	+115	+115	+115	+115	+115
	L 90		+115	+115	+115	+115	+115	+115
	L 120		+135	+135	+135	+135	+135	+135

	COD.	BRIDGE MELAMI- NICO KT1	BRIDGE LACCATO KT2	BRIDGE WOOD KT0	HEAD MELAMI- NICO KT8	HEAD LACCATO KT9	HEAD WOOD KT7		
 <p>scolapiatti H 72 apertura a pacchetto 2 ante H 36 griglie orion grau e raccogliocce plastica plate rack unit H 72 lift-up folding door 2 doors H 36 orion grau grilles and plastic drip tray</p>	L 45	E3081450	289	304	349	312	328	367	
	L 60	E3081600	299	319	377	326	346	408	
	L 90	E3081900	330	360	443	364	393	466	
	L 120	E3082200	493	529	—	498	543	—	
 <p>scolapiatti H 72 apertura a pacchetto 1 anta chiusa superiore H 36 1 anta vetro inferiore H 36 griglie orion grau e raccogliocce plastica N.B.: anta vetro senza maniglia plate rack unit H 72 lift-up folding door 1 full upper door H 36 1 glass lower door H 36 orion grau grilles and plastic drip tray Note: glass door without handle</p>									
	telaio alluminio L 45 aluminium frame	G3075450	382	392	402	382	392	402	
	L 60	G3075600	402	412	429	402	412	429	
	L 90	G3075900	451	464	495	451	464	495	
 <p>scolapiatti H 96 apertura a pacchetto 2 ante H 48 griglie orion grau e raccogliocce plastica plate rack unit H 96 lift-up folding door 2 doors H 48 orion grau grilles and plastic drip tray</p>	L 60	E3094600	329	356	430	357	382	452	
	L 90	E3094900	369	407	514	397	434	536	
 <p>scolapiatti H 96 apertura a pacchetto 1 anta chiusa superiore H 48 1 anta vetro inferiore H 48 griglie orion grau e raccogliocce plastica N.B.: anta vetro senza maniglia plate rack unit H 96 lift-up folding door 1 full upper door H 48 1 glass lower door H 48 orion grau grilles and plastic drip tray Note: glass door without handle</p>									
	telaio alluminio L 60 aluminium frame	G3098600	445	458	503	445	458	503	
	L 90	G3098900	504	522	584	504	522	584	
 <p>Maggiorazione kit luce LED DUAL COLOR calda (2700K) e naturale (4200K) interruttore ON/OFF "Touch" a sfioramento con alimentatore incluso Surcharge DUAL COLOR LED light kit warm (2700K) and natural (4200K) "Soft Touch" switch ON/OFF with power supplier</p>		opz.005							
	L 45		+100	+100	+100	+100	+100	+100	
	L 60		+105	+105	+105	+105	+105	+105	
	L 65		+105	+105	+105	+105	+105	+105	
	L 80		+115	+115	+115	+115	+115	+115	
	L 90		+115	+115	+115	+115	+115	+115	
	L 120		+135	+135	+135	+135	+135	+135	

CAPPE ASPIRANTI

EXTRACTOR HOODS

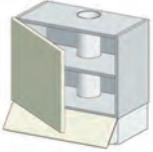
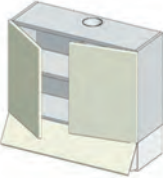
P 33

N.B.: cerniere ammortizzate di serie Note: standard blumotion hinges		COD.	BRIDGE MELAMI- NICO KT1	BRIDGE LACCATO KT2	BRIDGE WOOD KT0	HEAD MELAMI- NICO KT8	HEAD LACCATO KT9	HEAD WOOD KT7	
 <p>cappa estraibile 2 motori portata 275 m³/h con laterali in metallo, 1 anta N.B.: posizionare la cappa ad una distanza non inferiore ai 65 cm dal piano cottura</p> <p>slide-out hood 2 motors air flow rate 275 m³/h with metal sides, 1 door Note: position the hood at least 65 cm from the cooker hob</p>	H 63 L 60	E3600601/2	226	244	324	252	270	351	
	H 87 L 60	E3610601/2	241	264	360	266	290	388	
	n° 2 filtri carbone attivo 2 active carbon filters		+24	+24	+24	+24	+24	+24	
 <p>cappa estraibile 2 motori portata 275 m³/h con laterali in metallo, 2 ante N.B.: posizionare la cappa ad una distanza non inferiore ai 65 cm dal piano cottura</p> <p>slide-out hood 2 motors air flow rate 275 m³/h with metal sides, 2 doors Note: position the hood at least 65 cm from the cooker hob</p>	H 63 L 90	E3600900	267	294	421	304	332	462	
	H 87 L 90	E3610900	286	322	472	323	359	513	
	n° 2 filtri carbone attivo 2 active carbon filters		+24	+24	+24	+24	+24	+24	
 <p>cappa "Mod. F" integrata totale con frontalino vetro estraibile portata 390 m³/h con faretti a led 1 anta N.B.: posizionare la cappa ad una distanza non inferiore ai 55 cm dal piano cottura N.B.: realizzabile anche con apertura senza maniglia presa sul fondo (opz.997)</p> <p>"Mod. F" fully integrated hood with glass pull-out frontal panel air flow rate 390 m³/h, with led lights 1 door Note: position the hood at least 55 cm from the cooker hob Note: feasible even with grip on bottom opening (opz.997)</p>	H 60 L 60	EPC90461/2	462	476	495	508	524	544	
	H 72 L 60	EPC90561/2	469	487	510	516	534	558	
	H 96 L 60	EPC90661/2	497	520	559	543	567	608	
	H 108 L 60	EPC90761/2	515	541	583	566	589	632	
	n° 2 filtri carbone attivo 2 active carbon filters	08750894	31	31	31	31	31	31	
 <p>cappa "Mod. F" integrata totale con frontalino vetro estraibile portata 390 m³/h con faretti a led 2 ante N.B.: posizionare la cappa ad una distanza non inferiore ai 55 cm dal piano cottura N.B.: realizzabile anche con apertura senza maniglia presa sul fondo (opz.997)</p> <p>"Mod. F" fully integrated hood with glass pull-out front panel air flow rate 390 m³/h with led lights 2 doors Note: position the hood at least 55 cm from the cooker hob Note: feasible even with grip on bottom opening (opz.997)</p>	H 60 L 90	EPC90490	533	556	584	591	615	646	
	H 72 L 90	EPC90590	543	571	607	601	629	669	
	H 96 L 90	EPC90690	573	606	668	631	664	730	
	H 108 L 90	EPC90790	601	655	710	669	720	772	
	n° 2 filtri carbone attivo 2 active carbon filters	08750894	31	31	31	31	31	31	

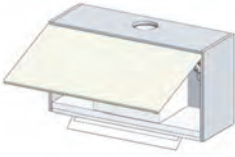
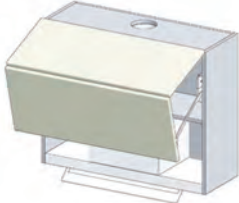
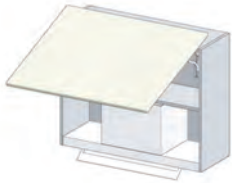
N.B.: cerniere ammortizzate di serie Note: standard blumotion hinges		COD.	BRIDGE	BRIDGE	BRIDGE	HEAD	HEAD	HEAD	
			MELAMI- NICO KT1	LACCATO KT2	WOOD KT0	MELAMI- NICO KT8	LACCATO KT9	WOOD KT7	
 <p>cappa "Mod. F" integrata totale con frontalino vetro estraibile portata 390 m³/h con faretti a led 1 anta apertura a ribalta N.B.: posizionare la cappa ad una distanza non inferiore ai 55 cm dal piano cottura N.B.: realizzabile anche con apertura senza maniglia presa sul fondo (opz.997)</p> <p>"Mod. F" fully integrated hood with glass pull-out front panel air flow rate 390 m³/h with led lights 1 flap door Note: position the hood at least 55 cm from the cooker hob Note: feasible even with grip on bottom opening (opz.997)</p>	H 36 L 60	EPC80260	467	476	494	514	524	543	
	H 36 L 90	EPC80290	522	537	560	576	590	610	
	H 36 L 120	EPC80320	616	634	—	649	667	—	
	H 48 L 60	EPC80360	507	507	689	541	554	738	
	H 48 L 90	EPC80390	553	571	745	606	625	795	
	H 48 L 120	EPC80420	791	818	—	824	851	—	
	H 60 L 60	EPC80460	631	647	588	678	694	637	
	H 60 L 90	EPC80490	713	735	676	766	789	726	
	n° 2 filtri carbone attivo 2 active carbon filters	08750894	28	28	28	28	28	28	
	 <p>cappa "Mod. F" integrata totale con frontalino vetro estraibile portata 390 m³/h con faretti a led 2 ante apertura a pacchetto N.B.: posizionare la cappa ad una distanza non inferiore ai 55 cm dal piano cottura N.B.: realizzabile anche con apertura senza maniglia presa sul fondo (opz.997)</p> <p>"Mod. F" fully integrated hood with glass pull-out front panel air flow rate 390 m³/h with led lights 2 lift-up folding doors Note: position the hood at least 55 cm from the cooker hob Note: feasible even with grip on bottom opening (opz.997)</p>	H 72 L 60	EPC83560	640	660	692	696	715	750
H 72 L 90		EPC83590	693	721	769	755	784	819	
H 72 L 120		EPC83620	808	844	—	841	886	—	
H 96 L 60		EPC83660	673	698	748	729	754	796	
H 96 L 90		EPC83690	734	771	843	790	827	892	
n° 2 filtri carbone attivo 2 active carbon filters		08750894	31	31	31	31	31	31	
 <p>cappa "Mod. F" integrata totale con frontalino vetro estraibile portata 390 m³/h 1 anta apertura verticale obliqua N.B.: posizionare la cappa ad una distanza non inferiore ai 55 cm dal piano cottura N.B.: realizzabile anche con apertura senza maniglia presa sul fondo (opz.997)</p> <p>"Mod. F" fully-integrated hood with glass pull-out front panel flow rate 390 m³/h with led lights 1 door with vertical oblique opening Note: position the hood at least 55 cm from the cooker hob Note: feasible even with grip on bottom opening (opz.997)</p>		H 60 L 60	EPC86460	617	632	645	664	679	694
	H 60 L 90	EPC86490	671	693	716	724	746	766	
	H 72 L 60	EPC86560	629	648	668	676	695	717	
	H 72 L 90	EPC86590	679	706	741	733	759	791	
	n° 2 filtri carbone attivo 2 active carbon filters	08750894	31	31	31	31	31	31	

N.B.: cerniere ammortizzate di serie

Note: standard blumotion hinges



Maggiorazione
cappa "NO DRIP" incasso pensile
portata 600 m³/h, per piano cottura ad
induzione
classe energetica A

Surcharge
"NO DRIP" built in hood air flow rate 600 m³/h
recommended for induction cooker hob
energetic class A

L 60

opz.006

+559

+559

+559

+559

+559

+559

L 90

opz.006

+559

+559

+559

+559

+559

+559

L 120

opz.006

+676

+676

—

+676

+676

—

filtro carbone attivo
active carbon filter

08750844R

+42

+42

+42

+42

+42

+42







PERCHÈ LA CAPPA "NO DRIP":





a differenza dei tradizionali piani cottura a gas dove la fiamma riscalda le superfici della cappa, nei piani cottura ad induzione i vapori condensano velocemente sulle superfici "fredde" della stessa, generando così gocce d'acqua che cadono sul p.c. sottostante. LA CAPPA "NO DRIP" È LA SOLUZIONE A QUESTO PROBLEMA.

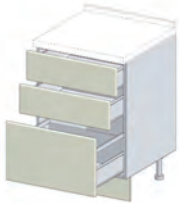

WHY THE "NO DRIP" HOOD:

unlike traditional gas hobs where the flame heats the surfaces of the hood, with induction hobs the vapors quickly condense on the "cold" surfaces of the hood, thus generating drops of water that fall on the hob below. THE "NO DRIP" HOOD IS THE SOLUTION TO THIS PROBLEM.

Le basi non sono comprensive di top - N.B.: cerniere ammortizzate di serie The base units do not include the tops - Note: standard blumotion hinges		COD.	BRIDGE	BRIDGE	BRIDGE	HEAD	HEAD	HEAD	
			MELAMI- NICO KT1	LACCATO KT2	WOOD KT0	MELAMI- NICO KT8	LACCATO KT9	WOOD KT7	
 <p>fascia tamponamento N.B.: la fascia è realizzata senza maniglia per la versione Head filler panel Note: panel realized without handle for Head version</p>	<p>L da 3 a 15 size from 3 to 15</p>	E4800000	51	57	76	51	57	76	
 <p>jolly base L da 10 a 30 jolly base unit size from 10 to 30</p>	<p>colore come struttura same colour as carcass melaminico come anta melamine same as door impiallacciato come anta (folding) veneered same as door (folding)</p>	E4700000	130	130	130	130	130	130	
		E4700030	180	—	—	180	—	—	
		E4707220	—	—	546	—	—	546	
 <p>1 anta 1 door</p>	<p>L 15 L 30 L 40 L 45 L 60 L 65</p>	E4010151/2	104	109	131	110	116	137	
		E4010301/2	109	118	147	120	130	158	
		E4010401/2	118	130	168	131	144	185	
		E4010451/2	124	138	178	138	152	196	
		E4010601/2	139	157	211	157	175	233	
		E4010651/2	145	165	223	164	183	242	
 <p>2 ante 2 doors</p>	<p>L 60 L 80 L 90</p>	E4010600	166	185	240	189	209	262	
		E4010800	186	212	281	214	239	315	
		E4010900	198	226	304	227	255	339	
 <p>cestello estraibile chiusura soft pull-out basket unit soft-closing system</p>	<p>L 15 L 30 L 45</p>	E4150150	144	150	158	150	156	168	
		E4150300	177	187	218	187	194	229	
		E4150450	193	209	252	204	218	269	
 <p>4 cassetti H 18 4 drawers H 18</p>	<p>L 30 L 40 L 45 L 60</p>	E4101300	284	295	366	330	343	414	
		E4101400	294	309	369	349	365	439	
		E4101450	303	320	405	361	379	477	
		E4101600	332	355	449	402	425	539	

Le basi non sono comprensive di top - N.B.: cassetti e cestoni ad estrazione totale con blumotion The base units do not include the tops - Note: fully extending drawers and deep drawers with blumotion system		COD.	BRIDGE	BRIDGE	BRIDGE	HEAD	HEAD	HEAD		
			MELAMI-NICO KT1	LACCATO KT2	WOOD KT0	MELAMI-NICO KT8	LACCATO KT9	WOOD KT7		
 <p>portaposate in plastica per cassetti plastic cutlery tray for drawers</p>	L 30	08700030X	10	10	10	10	10	10		
	L 40	08700040X	10	10	10	10	10	10		
	L 45	08700050X	10	10	10	10	10	10		
	L 60	08700060X	11	11	11	11	11	11		
	divisori regolabili L 90 adjustable separators	L 90	08700070X	32	32	32	32	32	32	
	divisori regolabili L 120 adjustable separators	L 120	08700075X	40	40	40	40	40	40	
 <p>2 cassetti H 18 1 cestone H 36 2 drawers H 18 1 deep drawer H 36</p>	L 45	E4131450	265	280	356	308	324	410		
	L 60	E4131600	285	306	398	338	359	465		
	L 90	E4131900	341	371	485	412	443	554		
	L 120	E4132200	540	543	—	628	634	—		
 <p>4 cassetti H 18 1 cestone H 36 4 drawers H 18 1 deep drawer H 36</p>	L 90	E4300900	481	512	668	563	595	763		
 <p>2 cestoni H 36 2 deep drawers H 36</p>	L 45	E4171450	225	239	306	253	268	341		
	L 60	E4171600	246	265	345	280	300	389		
	L 90	E4171900	292	320	424	339	368	470		
	L 120	E4172200	459	485	—	518	543	—		
 <p>1 cassetto H 12 1 anta H 60 1 drawer H 12 1 door H 60</p>	L 45	E4021451/2	183	198	249	212	227	284		
 <p>1 cassetto H 12 2 ante H 60 1 drawer H 12 2 doors H 60</p>	L 90	E4021900	265	295	383	318	348	442		

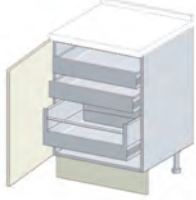
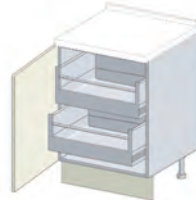
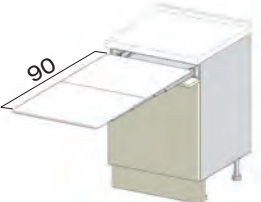
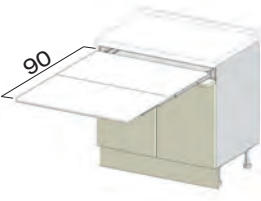
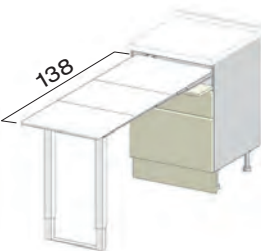
Le basi non sono comprensive di top - N.B.: cassetti e cestoni ad estrazione totale con blumotion The base units do not include the tops - Note: fully extending drawers and deep drawers with blumotion system		COD.	BRIDGE MELAMI- NICO KT1	BRIDGE LACCATO KT2	BRIDGE WOOD KT0	HEAD MELAMI- NICO KT8	HEAD LACCATO KT9	HEAD WOOD KT7	
 <p>1 anta 2 cassetti interni 1 cestone interno posizionare a 5 cm dalla parete laterale 1 door 2 internal drawers 1 internal deep drawer place at 5 cm from the side wall</p>	L 45	E4236461/2	311	325	392	325	339	410	
	L 60	E4236611/2	336	356	441	356	374	462	
 <p>1 anta 2 cestoni interni posizionare a 5 cm dalla parete laterale 1 door 2 internal deep drawers place at 5 cm from the side wall</p>	L 45	E4236471/2	269	283	350	283	298	367	
	L 60	E4236621/2	295	313	394	312	331	416	
 <p>base tavolo estraibile LUNCH portata 60 kg 1 frontale H 12 1 anta H 60 base unit with pull-out table LUNCH load capacity kg 60 1 door H 60 1 front H 12</p>	L 60	E4230601/2	599	619	704	634	654	748	
	L 90	E4230900	659	689	798	712	742	857	
 <p>base tavolo estraibile LUNCH portata 60 kg 1 frontale H 12 2 ante H 60 base unit with pull-out table LUNCH load capacity kg 60 2 doors H 60 1 front H 12</p>	L 60	E4234600	1.229	1.252	1.299	1.310	1.325	1.370	
	L 90	E4234900	1.303	1.334	1.410	1.390	1.429	1.480	
 <p>base tavolo estraibile PARTY gamba telescopica in alluminio portata 100 kg 1 frontale H 18 1 cassetto H 18 1 cestone H 36 base unit with pull-out table PARTY telescopic legs in aluminium load capacity kg 100 1 front H 18 1 drawers H 18 1 deep drawer H 36</p>	L 60	E4234600	1.229	1.252	1.299	1.310	1.325	1.370	
	L 90	E4234900	1.303	1.334	1.410	1.390	1.429	1.480	

BASI ANGOLO

CORNER BASE UNITS

H 85 P 65

Le basi non sono comprensive di top - N.B.: cerniere ammortizzate di serie The base units do not include the tops - Note: standard blumotion hinges		COD.	BRIDGE MELAMI- NICO KT1	BRIDGE LACCATO KT2	BRIDGE WOOD KT0	HEAD MELAMI- NICO KT8	HEAD LACCATO KT9	HEAD WOOD KT7	
 <p>angolo L 95 1 ripiano 1 anta L 30 (cerniere a pilastro) cassone 90 corner unit W 95 1 shelf 1 door W 30 (pillar hinges) structure 90</p> <p>verso dx RH version</p>	95x65	E4400951/2	232	242	291	248	254	302	
 <p>angolo L 105 1 ripiano 1 anta L 40 (cerniere a pilastro) cassone 90 corner unit W 105 1 shelf 1 door W 40 (pillar hinges) structure 90</p> <p>verso dx RH version</p>	105x65	E4401041/2	236	247	303	254	264	320	
 <p>angolo L 110 1 ripiano 1 anta L 45 (cerniere a pilastro) cassone 105 corner unit W 110 1 shelf 1 door W 45 (pillar hinges) structure 105</p> <p>verso dx RH version</p>	110x65	E4401091/2	254	267	330	269	281	348	
 <p>angolo L 125 1 ripiano 1 anta L 60 (cerniere a pilastro) cassone 120 con tirante corner unit W 125 1 shelf 1 door W 60 (pillar hinges) structure 120 with tie beam</p> <p>verso dx RH version</p>	125x65	E4401241/2	279	296	370	297	313	391	
 <p>angolo L 145 1 ripiano 2 ante L 40 cassone 140 con tirante corner unit W 145 1 shelf 2 doors W 40 structure 140 with tie beam</p> <p>verso dx RH version</p>	145x65	E4401451/2	333	356	454	360	384	487	
 <p>angolo L 155 1 ripiano 2 ante L 45 cassone 150 con tirante corner unit W 155 1 shelf 2 doors W 45 structure 150 with tie beam</p> <p>verso dx RH version</p>	155x65	E4401551/2	343	370	474	372	399	509	

BASI ANGOLO

CORNER BASE UNITS

H 85 P 65

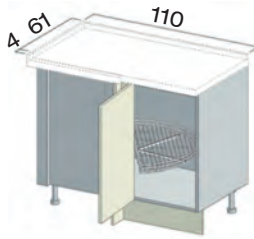
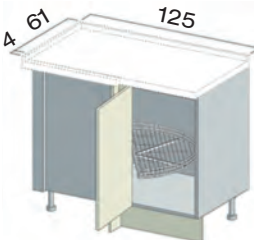
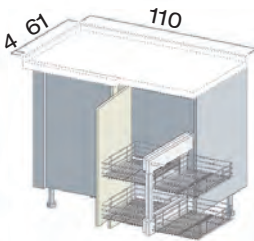
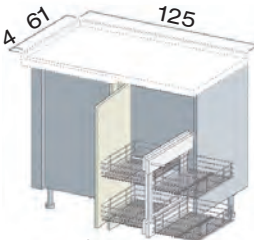
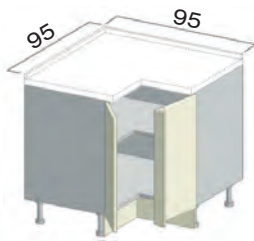
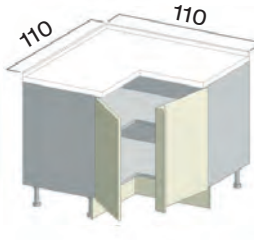
Le basi non sono comprensive di top - N.B.: cerniere ammortizzate di serie The base units do not include the tops - Note: standard blumotion hinges		COD.	BRIDGE MELAMI- NICO KT1	BRIDGE LACCATO KT2	BRIDGE WOOD KT0	HEAD MELAMI- NICO KT8	HEAD LACCATO KT9	HEAD WOOD KT7	
 <p>angolo L 110 cestello mezzaluna orion grau 1 anta L 45 (cerniere a pilastro) cassone 105 corner unit W 110 crescent-shaped orion grau wire basket unit 1 door W 45 (pillar hinges) structure 105</p> <p>verso dx RH version</p>	<p>1 cestello 110x65 1 basket drawer</p>	E4401101/2	254	267	330	269	281	348	
	<p>2 cestelli 110x65 2 basket drawers</p>	E4401111/2	282	294	359	296	309	377	
 <p>angolo L 125 cestello mezzaluna orion grau 1 anta L 60 (cerniere a pilastro) cassone 120 corner unit W 125 crescent-shaped orion grau wire basket unit 1 door W 60 (pillar hinges) structure 120</p> <p>verso dx RH version</p>	<p>1 cestello 125x65 1 basket unit</p>	E4401251/2	268	285	370	286	303	391	
	<p>2 cestelli 125x65 2 basket units</p>	E4401261/2	296	313	389	314	330	411	
 <p>angolo L 110 4 cestelli orion grau estraibili indipendenti dall'anta 1 anta L 45 (cerniere a pilastro) cassone 105 corner unit W 110 4 pull-out orion grau basket unit opening independently from door 1 door W 45 (pillar hinges) structure 105</p> <p>verso dx RH version</p>									
	110x65	E4451101/2	779	787	849	779	791	867	
 <p>angolo L 125 4 cestelli orion grau estraibili indipendenti dall'anta 1 anta L 60 (cerniere a pilastro) cassone 120 corner unit W 125 4 pull-out orion grau basket units opening independently from door 1 door W 60 (pillar hinges) structure 120</p> <p>verso dx RH version</p>									
	125x65	E4451251/2	828	845	922	846	863	944	
 <p>angolo 95x95 1 ripiano 2 ante L 30 (cerniere 180°) angolare unito all'anta dx corner unit 95x95 1 shelf 2 doors W 30 (180° hinges) angular filler attached to the RH corner</p>									
	95x95	E4481950	534	549	599	555	575	622	
 <p>angolo 110x110 1 ripiano 2 ante L 45 (cerniere 180°) angolare unito all'anta dx corner unit 110x110 1 shelf 2 doors W 45 (180° hinges) angular filler attached to the RH corner</p>									
	110x110	E4482100	589	601	679	604	634	715	

BASI ANGOLO PANNELLO COME ANTA

H 85 P 61

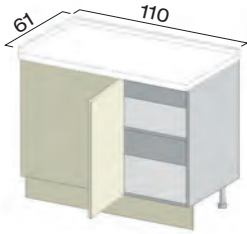
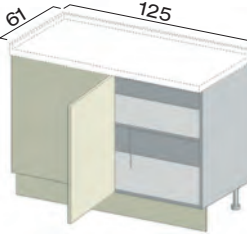
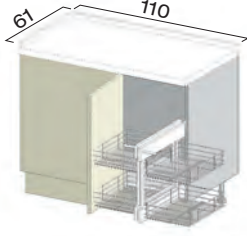
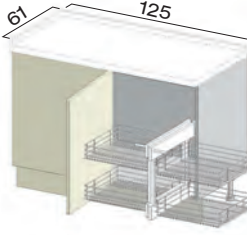
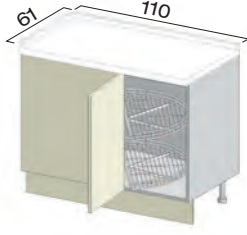
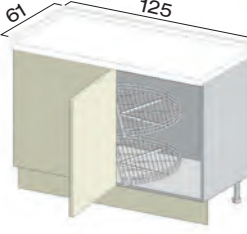

CORNER BASE UNITS PANEL AS DOOR

LE BASI NON SONO COMPRENSIVE DI TOP THE BASE UNITS DO NOT INCLUDE THE TOPS		COD.	BRIDGE MELAMI- NICO KT1	BRIDGE LACCATO KT2	BRIDGE WOOD KT0	HEAD MELAMI- NICO KT8	HEAD LACCATO KT9	HEAD WOOD KT7
 <p>angolo L 110 1 ripiano 1 anta L 45 pannello come anta cassone 110 corner unit W 110 1 shelf 1 door W 45 panel as door structure 110</p> <p>verso dx RH version</p>	110x61	E4403091/2	245	279	370	269	302	397
	 <p>angolo L 125 1 ripiano 1 anta L 60 pannello come anta cassone 125 con tirante corner unit W 125 1 shelf 1 door W 60 panel as door structure 125 with tie beam</p> <p>verso dx RH version</p>	125x61	E4403241/2	261	285	419	288	312
 <p>angolo L 110 4 cestelli orion grau estraibili indipendenti dall'anta 1 anta L 45 pannello come anta cassone 110 corner unit W 110 4 pull-out orion grau basket units opening independently from door 1 door W 45 panel as door structure 110</p> <p>verso dx RH version</p>	110x61	E4453101/2	755	789	886	779	812	912
	 <p>angolo L 125 4 cestelli orion grau estraibili indipendenti dall'anta 1 anta L 60 pannello come anta cassone 125 corner unit W 125 4 pull-out orion grau basket units opening independently from door 1 door W 60 panel as door structure 125</p> <p>verso dx RH version</p>	125x61	E4453251/2	821	845	961	848	872
 <p>angolo L 110 2 cestelli mezzaluna orion grau 1 anta L 45 pannello come anta cassone 110 corner unit W 110 2 crescent-shaped orion grau wire basket units 1 door W 45 panel as door structure 110</p> <p>verso dx RH version</p>	110x61	E4403111/2	266	301	396	291	325	422
	 <p>angolo L 125 2 cestelli mezzaluna orion grau 1 anta L 60 pannello come anta cassone 125 corner unit W 125 2 crescent-shaped orion grau wire basket units 1 door W 60 panel as door structure 125</p> <p>verso dx RH version</p>	125x61	E4403261/2	280	318	428	306	344

BASI PER FORNI

H 85 P 61

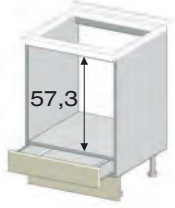
OVEN BASE UNITS

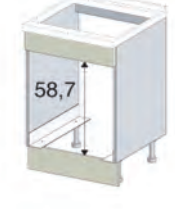
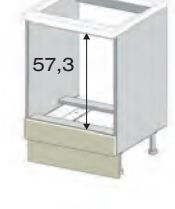
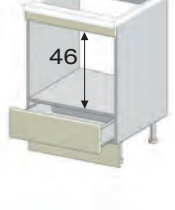
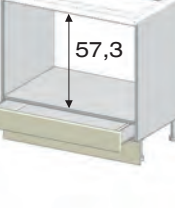

Le basi non sono comprensive di top - N.B.: cassetti ad estrazione totale con blumotion The base units do not include the tops - Note: fully extending drawers with blumotion system		COD.	BRIDGE MELAMI- NICO KT1	BRIDGE LACCATO KT2	BRIDGE WOOD KT0	HEAD MELAMI- NICO KT8	HEAD LACCATO KT9	HEAD WOOD KT7	
 <p>base per forno elettrico H 60 cassetto H 12 inferiore N.B.: la versione Head è realizzata solo con la maniglia 920T electric oven base unit H 60 lower drawer H 12 Note: only realized with handle 920T for Head version</p>	L 60	E5510607	179	186	198	197	203	221	
	 <p>base per forno elettrico H 60 cassetto H 12 superiore electric oven base unit H 60 upper drawer H 12</p>	L 60	E5510608	179	186	198	187	192	221
 <p>base per forno elettrico H 60 frontale superiore fisso H 12 N.B.: da utilizzare per top H 2 e per P.C. filo top electric oven base unit H 60 fixed upper front H 12 Note: to be used in conjunction with tops H 2 and flush hobs</p>		L 60	E5510620	122	132	137	144	163	165
	 <p>base per forno gas H 60 frontale inferiore fisso H 12 gas oven base unit H 60 fixed lower front H 12</p>	L 60	E5520600	123	135	139	123	135	138
 <p>base per forno elettrico H 46 fascia superiore H 8,1 cassetto H 18 electric oven base unit H 46 upper filler H 8,1 drawer H 18</p>		L 60	E5530600	194	202	227	239	221	250
	 <p>base per maxiforno H 60 cassetto H 12 N.B.: la versione Head è realizzata solo con la maniglia 920T maxi-oven base unit H 60 drawer H 12 Note: only realized with handle 920T for Head version</p>	L 90	E5510907	217	223	240	242	248	264

BASI PER FORNI

H 85 P 61

OVEN BASE UNITS

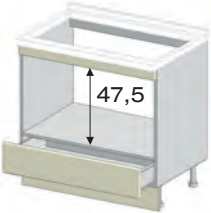
Le basi non sono comprensive di top - N.B.: cassetti ad estrazione totale con blumotion
 The base units do not include the tops - Note: fully extending drawers with blumotion system

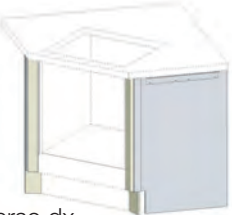
	COD.	BRIDGE MELAMI- NICO KT1	BRIDGE LACCATO KT2	BRIDGE WOOD KT0	HEAD MELAMI- NICO KT8	HEAD LACCATO KT9	HEAD WOOD KT7	
 <p>base per maxiforno H 48 fascia superiore H 5,9 cassetto H 18 maxi-oven base unit H 48 upper filler H 5,9 drawer H 18</p>								
	L 90	E5510920	225	243	271	249	266	295
 <p>kit raccordo base angolo junction kit corner base unit</p>								
	110x110	E5471100	120	134	120	120	134	120
 <p>kit raccordo base angolo per inserimento lavastoviglie a destra o sinistra junction kit for corner base unit for dishwasher placed on the right or the left side</p> <p>verso dx RH version</p>								
	110x110	E5471151/2	153	169	158	153	169	158

BASI PER PIANI COTTURA

H 85 P 61

COOKER HOB BASE UNITS



Le basi non sono comprensive di top - N.B.: cassetti e cestoni ad estrazione totale con blumotion
The base units do not include the tops - Note: fully extending drawers and deep drawers with blumotion system

	COD.	BRIDGE MELAMI- NICO KT1	BRIDGE LACCATO KT2	BRIDGE WOOD KT0	HEAD MELAMI- NICO KT8	HEAD LACCATO KT9	HEAD WOOD KT7	
 <p>base predisposta piano cottura 1 anta base unit configured for cooker hob 1 door</p>	L 60	E5500601/2	147	165	211	165	183	233
		opz.101	+55	+55	+55	+55	+55	+55
			mag.base piano cottura ad induzione surcharge base unit for induction cooker hob					
 <p>base predisposta piano cottura 2 ante base unit configured for cooker hob 2 doors</p>	L 90	E5500900	204	232	304	233	262	339
		opz.101	+55	+55	+55	+55	+55	+55
			mag.base piano cottura ad induzione surcharge base unit for induction cooker hob					
 <p>Maggiorazione per base predisposta piano cottura ad induzione con lamierino di protezione N.B.: realizzabile su base 2 cassetti+1 cestone, base 2 cestoni e base 4 cassette Surcharge for base unit configured for induction cooker hob with protection metal sheet Note: available on base unit 2 drawers+1 deep drawer, base unit 2 deep drawers and base unit 4 drawers</p>		opz.101	+55	+55	+55	+55	+55	+55
			mag.base piano cottura ad induzione surcharge base unit for induction cooker hob					
 <p>base predisposta piano cottura con cappa integrata 1 frontale superiore fisso H 18 1 cassetto H 18 P 40 1 cestone H 36 P 40 base unit configured for cooker hob with integrated hood 1 fixed upper front H 18 1 drawer H 18 D 40 1 deep drawer H 36 D 40</p>	L 90	E5509090	313	347	441	369	403	496
	L 120	E5509120	381	415	—	471	477	—
			mag.base piano cottura ad induzione surcharge base unit for induction cooker hob					
 <p>base predisposta piano cottura con cappa integrata 1 anta vasistas H 36 1 cestone H 36 P 40 base unit configured for cooker hob with integrated hood 1 flap door H 36 1 deep drawer H 36 D 40</p>	L 90	E5509095	399	429	526	447	476	572
	L 120	E5509125	488	530	—	551	565	—
			mag.base piano cottura ad induzione surcharge base unit for induction cooker hob					
 <p>Esempio di piano cottura con cappa integrata Example of cooker hob with integrated hood</p>								

SOTTOLAVELLI

SINK BASE UNITS

H 85 P 61

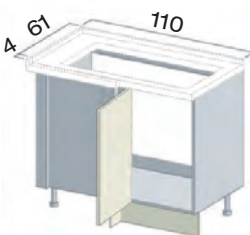
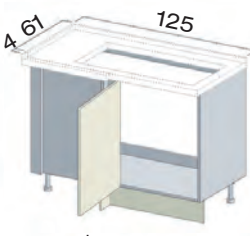
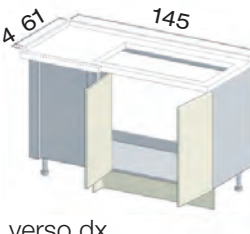
Le basi non sono comprensive di top - N.B.: cerniere ammortizzate di serie The base units do not include the tops - Note: standard blumotion hinges		COD.	BRIDGE MELAMI- NICO KT1	BRIDGE LACCATO KT2	BRIDGE WOOD KT0	HEAD MELAMI- NICO KT8	HEAD LACCATO KT9	HEAD WOOD KT7	
 <p>sottolavello 1 anta sink base unit 1 door</p>	L 45	E5010451/2	122	136	177	136	150	195	
	L 60	E5010601/2	136	154	209	153	171	230	
 <p>sottolavello 2 ante sink base unit 2 doors</p>	L 60	E5010600	159	179	234	183	203	257	
	L 80	E5010800	181	207	276	209	234	310	
	L 90	E5010900	188	216	294	216	245	329	
	L 120	E5011200	220	257	359	255	292	403	
 <p>sottolavello 2 cestoni H 36 cestone superiore sagomato con vaschette sink base unit 2 deep drawers H 36 contoured upper deep drawer with trays</p>	L 60	E5200600	282	301	379	317	337	422	
	L 90	E5200900	325	353	465	372	401	510	
	L 120	E5201200	476	514	—	535	574	—	
 <p>sottolavello angolo L 110 1 anta L 45 (cerniere pilastro) cassone 105 corner sink base unit W 110 1 door W 45 (pillar hinges) structure 105</p> <p>verso dx RH version</p>	110x65	E4421101/2	233	241	304	244	253	322	
 <p>sottolavello angolo L 125 1 anta L 60 (cerniere pilastro) cassone 120 corner sink base unit W 125 1 door W 60 (pillar hinges) structure 120</p> <p>verso dx RH version</p>	125x65	E4421251/2	250	261	335	265	278	357	
 <p>sottolavello angolo L 145 2 ante L 40 (cerniere pilastro) cassone 140 corner sink base unit W 145 2 doors W 40 (pillar hinges) structure 140</p> <p>verso dx RH version</p>	145x65	E4421451/2	290	307	404	313	334	438	

SOTTOLAVELLI

H 85 P 61

SINK BASE UNITS

Le basi non sono comprensive di top - N.B.: cerniere ammortizzate di serie
 The base units do not include the tops - Note: standard blumotion hinges

COD.

BRIDGE
MELAMI-
NICO
KT1

BRIDGE
LACCATO
KT2

BRIDGE
WOOD
KT0

HEAD
MELAMI-
NICO
KT8

HEAD
LACCATO
KT9

HEAD
WOOD
KT7

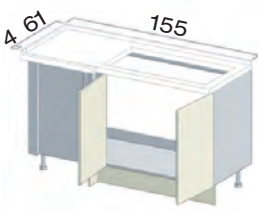

sottolavello angolo L 155
2 ante L 45 (cerniere pilastro)
cassone 150
 corner sink base unit W 155
 2 doors W 45 (pillar hinges)
 structure 150

verso dx
 RH version

155x65

E4421551/2

297

323

423

321

353

458

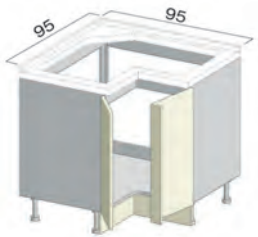

sottolavello angolo 95x95
2 ante L 30 (cerniere 180°)
angolare unito all'anta dx
 corner sink base unit 95x95
 2 doors W 30 (180° hinges)
 angular filler attached to the RH door

95x95

E5021950

494

512

603

517

535

625

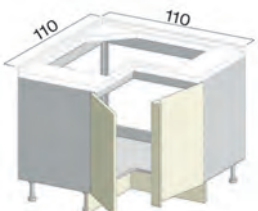

sottolavello angolo 110x110
2 ante L 45 (cerniere 180°)
angolare unito all'anta dx
 corner sink base unit 110x110
 2 doors W 45 (180° hinges)
 angular filler attached to the RH door

110x110

E5022100

533

549

686

551

578





721

BASI PER ELETTRODOMESTICI SOTTOTOP

H 85 P 61

BASE UNITS FOR UNDER-TOP APPLIANCES

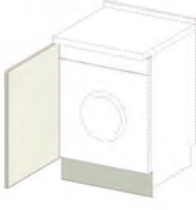

Le basi non sono comprensive di top
The base units do not include the tops

	COD.	BRIDGE MELAMI- NICO KT1	BRIDGE LACCATO KT2	BRIDGE WOOD KT0	HEAD MELAMI- NICO KT8	HEAD LACCATO KT9	HEAD WOOD KT7	
 <p>anta per lavastoviglie scomparsa totale completa di kit protezione fianchi door for fully integrated dishwasher with protection kit for side panels</p>	L 45	E4490080	64	78	110	79	94	129
	L 60	E4490090	60	79	142	78	98	180
 <p>anta per lavastoviglie scomparsa totale estetica 2 cestoni completa di kit protezione fianchi door for fully integrated dishwasher 2 deep drawers aesthetic with protection kit for side panels</p>	L 60	E4490100	99	122	166	130	160	213
 <p>anta per lavastoviglie comandi a vista completa di kit protezione fianchi door for dishwasher with visible controls with protection kit for side panels</p>	L 45	E4490050	48	57	90	48	57	99
	L 60	E4490060	58	70	109	58	70	119
 <p>kit protezione fianchi per lavastoviglie protection kit for side panels for dishwasher</p> 								
 <p>anta per lavabiancheria scomparsa totale door for fully integrated washing machine</p>	L 60	E4490011/2	76	95	142	94	114	180

BASI PER ELETTRODOMESTICI SOTTOTOP

H 85 P 61

BASE UNITS FOR UNDER-TOP APPLIANCES







Le basi non sono comprensive di top The base units do not include the tops		COD.	BRIDGE MELAMI- NICO KT1	BRIDGE LACCATO KT2	BRIDGE WOOD KT0	HEAD MELAMI- NICO KT8	HEAD LACCATO KT9	HEAD WOOD KT7
 <p>anta con fianco per frigo e congelatore sottotop door with side panel for under-top fridge and freezer</p>	L 60	E4490151/2	101	120	167	119	139	200
	 <p>anta per frigo e congelatore sottotop door for under-top fridge and freezer</p>	L 60	E4490181/2	76	95	142	94	114
 <p>fianco per elettrodomestici a fine composizione side panel for appliances placed at the end of the composition</p>								
	H 85x60x1,8 zoccolo H 13 in nobilitato melamine coated	T94613	25	25	25	25	25	25
	H 85x59,6x1,8 zoccolo H 13 come anta same as door	T94704	49	—	117	49	—	117
	H 85x59,7x1,9 zoccolo H 13 laccato come anta lacquered same as door	T947041	—	75	—	—	75	—

BASI E SOTTOLAVELLI H 73

H 73 P 61

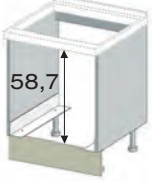
BASE UNITS AND SINK BASE UNITS H 73

Le basi non sono comprensive di top - N.B.: cerniere ammortizzate di serie
The base units do not include the tops - Note: standard blumotion hinges







		COD.	BRIDGE MELAMI- NICO KT1	BRIDGE LACCATO KT2	BRIDGE WOOD KT0	HEAD MELAMI- NICO KT8	HEAD LACCATO KT9	HEAD WOOD KT7	
 <p>base H 73 1 anta base unit H 73 1 door</p>	L 45	E4030451/2	126	138	170	141	153	187	
	L 60	E4030601/2	141	156	198	158	174	220	
 <p>base H 73 2 ante base unit H 73 2 doors</p>	L 90	E4030900	198	222	284	227	252	320	
	L 120	E4031200	227	258	358	277	294	403	
 <p>base H 73 2 cassetti H 18 1 cassetto H 24 base unit H 73 2 drawers H 18 1 drawer H 24</p>	L 45	E4250450	260	276	340	303	320	395	
	L 60	E4250600	293	307	374	341	360	442	
	L 90	E4250900	335	361	457	406	433	527	
	L 120	E4251200	433	465	—	544	559	—	
 <p>base H 73 predisposta per forno H 60 base unit H 73 configured for oven H 60</p>	L 60	E5540600	116	116	116	116	116	116	
 <p>sottolavello H 73 1 anta sink base unit H 73 1 door</p>	L 45	E5060451/2	126	136	166	138	149	183	
	L 60	E5060601/2	138	152	192	153	168	214	
 <p>sottolavello H 73 2 ante sink base unit H 73 2 doors</p>	L 90	E5060900	186	210	272	215	239	307	
	L 120	E5061200	217	247	328	252	283	372	
 <p>sottolavello H 73 1 cestone H 60 con scarico salvaspazio sink base unit H 73 1 deep drawer H 60 with space-saver drain piping</p>	L 60	E5260600	219	238	296	241	256	317	
	L 90	E5260900	247	273	350	274	297	373	
	L 120	E5261200	304	330	—	360	371	—	

BASI SOSPENSE con Attaccaglie e Barre Fissaggio a parete

H 36 - 48 - 60 P 61

HANGING BASE UNITS with Hangers and Rods for wall mounting





Le basi non sono comprensive di top - N.B.: cerniere ammortizzate di serie
The base units do not include the tops - Note: standard blumotion hinges

	COD.	BRIDGE MELAMI- NICO KT1	BRIDGE LACCATO KT2	BRIDGE WOOD KT0	HEAD MELAMI- NICO KT8	HEAD LACCATO KT9	HEAD WOOD KT7	
 <p>base H 36 1 anta base unit H 36 1 door</p>	L 45	E4321451/2	116	124	143	131	138	161
	L 60	E4321601/2	124	136	161	142	152	183
 <p>base H 48 1 anta base unit H 48 1 door</p>	L 45	E4320451/2	136	141	169	146	156	187
	L 60	E4320601/2	145	158	193	160	171	215
 <p>base H 60 1 anta base unit H 60 1 door</p>	L 45	E4322451/2	144	155	187	158	170	204
	L 60	E4322601/2	154	169	215	171	187	237
 <p>base H 36 2 ante base unit H 36 2 doors</p>	L 90	E4321900	163	177	219	186	201	254
	L 120	E4322200	189	205	252	220	240	295
 <p>base H 48 2 ante base unit H 48 2 doors</p>	L 90	E4320900	192	207	264	217	236	299
	L 120	E4321200	225	246	324	270	281	368
 <p>base H 60 2 ante base unit H 60 2 doors</p>	L 90	E4322900	204	228	293	233	257	328

BASI SOSPESSE con Attaccaglie e Barre Fissaggio a parete

H 36 - 48 - 60 P 61

HANGING BASE UNITS with Hangers and Rods for wall mounting

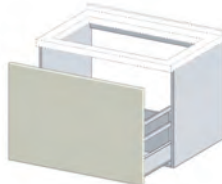
Le basi non sono comprensive di top - N.B.: cassetti e cestoni ad estrazione totale con blumotion The base units do not include the tops - Note: fully extending drawers and deep drawers with blumotion system		COD.	BRIDGE MELAMI- NICO KT1	BRIDGE LACCATO KT2	BRIDGE WOOD KT0	HEAD MELAMI- NICO KT8	HEAD LACCATO KT9	HEAD WOOD KT7	
 <p>base H 36 1 cestone base H 36 1 deep drawer</p>	L 45	E4311450	166	168	196	175	183	214	
	L 60	E4311600	178	184	218	188	198	240	
	L 90	E4311900	204	217	261	220	235	284	
	L 120	E4312200	223	244	—	254	274	—	
 <p>base H 48 1 cestone base unit H 48 1 deep drawer</p>	L 45	E4310450	179	184	218	189	198	235	
	L 60	E4310600	189	197	243	202	215	265	
	L 90	E4310900	218	232	294	237	256	317	
	L 120	E4311200	243	269	—	274	300	—	
 <p>base H 60 1 cestone 1 cassetto interno base unit H 60 1 deep drawer 1 internal drawer</p>	L 45	E4312450	282	293	337	296	308	354	
	L 60	E4312600	298	313	371	315	331	393	
	L 90	E4312900	345	367	445	369	391	468	
 <p>sottolavello H 48 1 cestone sagomato scarico salvaspazio sink base unit H 48 1 contoured deep drawer space-saver drain piping</p>	L 90	E5240900	270	289	352	295	313	375	
 <p>sottolavello H 60 1 cestone scarico salvaspazio sink base unit H 60 1 deep drawer with space-saver drain piping</p>	L 60	E5250600	243	258	302	260	276	324	
	L 90	E5250900	268	291	359	292	315	381	
	L 120	E5251200	303	329	—	333	360	—	

COMPOSIZIONE CON ELEMENTI INCLINATI

COMPOSITION WITH INCLINED ELEMENTS

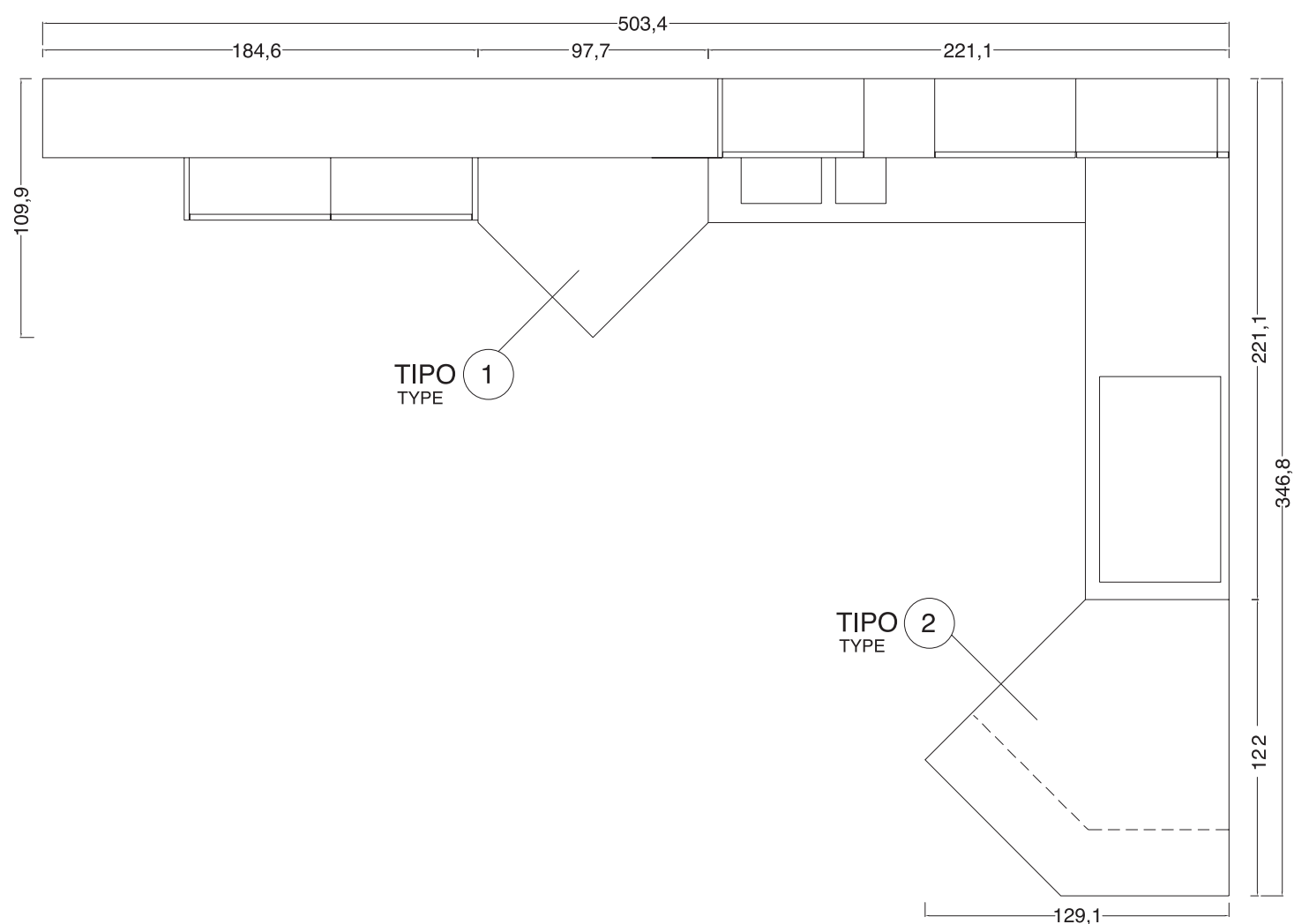
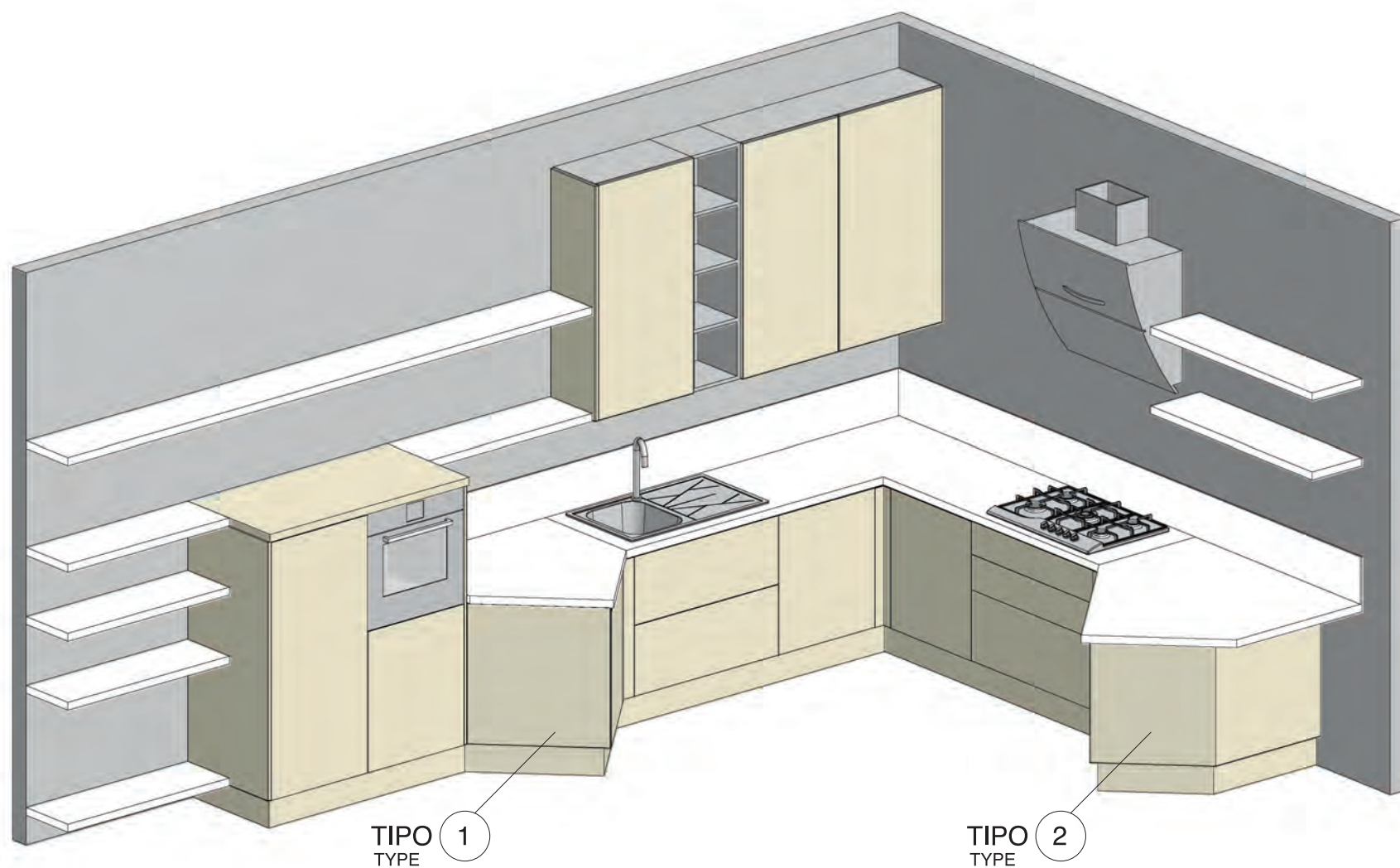

BASE INCLINATA "TIPO 1"

INCLINED BASE UNIT "TYPE 1"

LE BASI NON SONO COMPRENSIVE DI TOP
THE BASE UNITS DO NOT INCLUDE THE TOPS

kit base inclinata "tipo 1" per vano L 60
inclined base unit "type 1" kit W 60

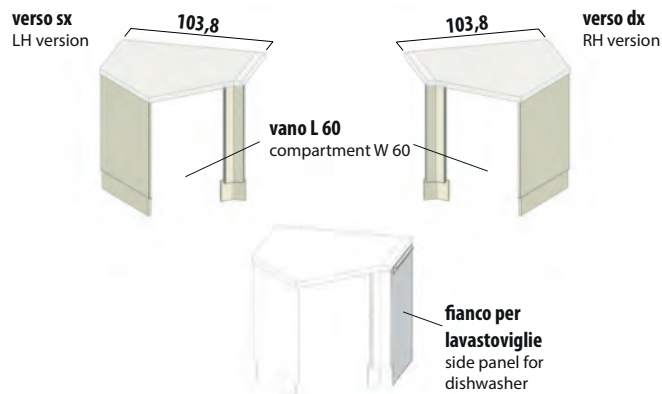

kit "tipo 1"
"type 1" kit

mag. inserimento fianco per lavastoviglie dx o sx
surcharge for dishwasher side panel placed on RH or LH side

top per base inclinata "tipo 1"
worktop for inclined base unit "type 1"

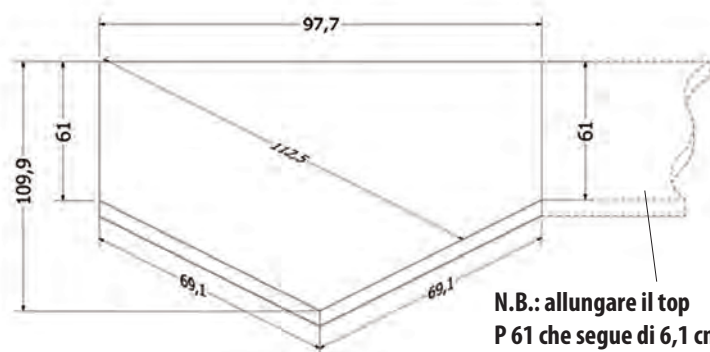

verso sx
LH version

N.B.: allungare il top P 61 che segue di 6,1 cm
Note: add. 6,1 cm to the worktop next to the inclined base unit

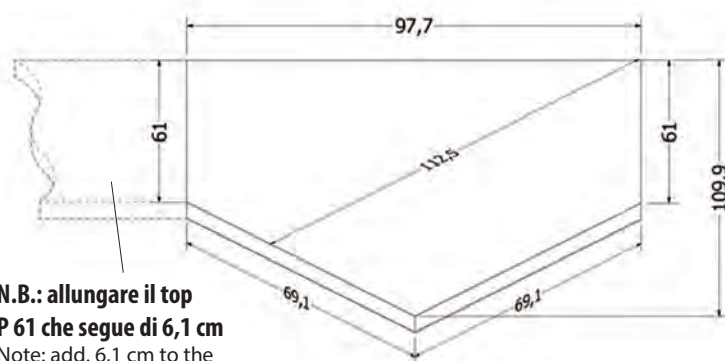

verso dx
RH version

N.B.: allungare il top P 61 che segue di 6,1 cm
Note: add. 6,1 cm to the worktop next to the inclined base unit

COD.	BRIDGE MELAMI- NICO KT1	BRIDGE LACCATO KT2	BRIDGE WOOD KT0	HEAD MELAMI- NICO KT8	HEAD LACCATO KT9	HEAD WOOD KT7	
E4910051/2	128	159	216	128	159	234	
opz.002	+40	+40	+40	+40	+40	+40	
97,7x109,9 lamin.bordo ABS1							
H 4 T9062621/2							
97,7x109,9 laminato Fenix NTM							
H 2 TFEN2681/2	VEDI	VEDI	VEDI	VEDI	VEDI	VEDI	
H 4 TFEN4681/2	LISTINO	LISTINO	LISTINO	LISTINO	LISTINO	LISTINO	
	TOP	TOP	TOP	TOP	TOP	TOP	
97,7x109,9 quarzo pasta piena profilo P							
H 2 TQRP2681/2							
fascia "A"	VEDI	VEDI	VEDI	VEDI	VEDI	VEDI	
fascia "B"	LISTINO	LISTINO	LISTINO	LISTINO	LISTINO	LISTINO	
fascia "C"	TOP	TOP	TOP	TOP	TOP	TOP	
H 3 TQRP3681/2							
fascia "A"	VEDI	VEDI	VEDI	VEDI	VEDI	VEDI	
fascia "B"	LISTINO	LISTINO	LISTINO	LISTINO	LISTINO	LISTINO	
fascia "C"	TOP	TOP	TOP	TOP	TOP	TOP	
97,7x109,9 quarzo bordo quarzo profilo P							
H 4 TQRP4681/2							
fascia "A"	VEDI	VEDI	VEDI	VEDI	VEDI	VEDI	
fascia "B"	LISTINO	LISTINO	LISTINO	LISTINO	LISTINO	LISTINO	
fascia "C"	TOP	TOP	TOP	TOP	TOP	TOP	

BASE INCLINATA SNACK "TIPO 2"

INCLINED SNACK BASE UNIT "TYPE 2"

LE BASI NON SONO COMPRENSIVE DI TOP
THE BASE UNITS DO NOT INCLUDE THE TOPS

kit base snack "tipo 2" per vano L 60
inclined snack base unit "type 2" kit W 60

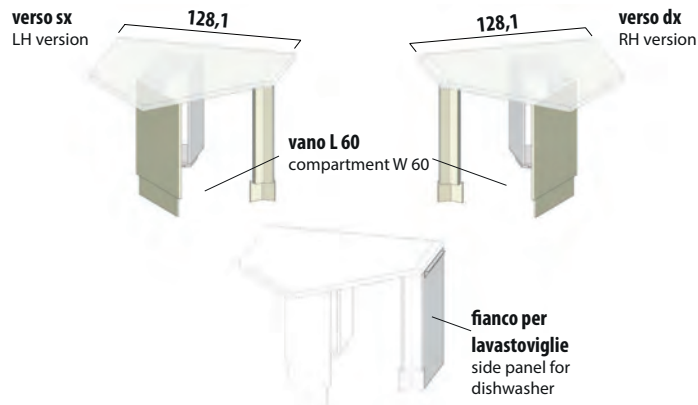

kit "tipo 2"
"type 2" kit

mag. inserimento fianco per lavastoviglie dx o sx
surcharge for dishwasher side panel placed on RH or LH side

top per base snack "tipo 2"
worktop for inclined snack base unit "type 2"

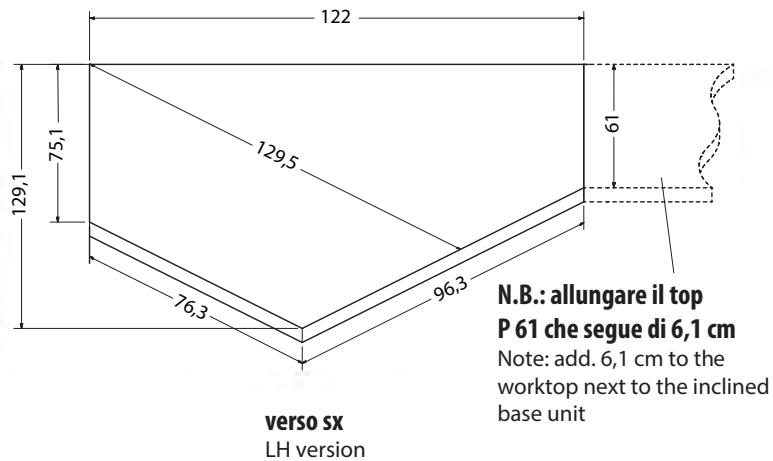

N.B.: allungare il top P 61 che segue di 6,1 cm
Note: add. 6,1 cm to the worktop next to the inclined base unit

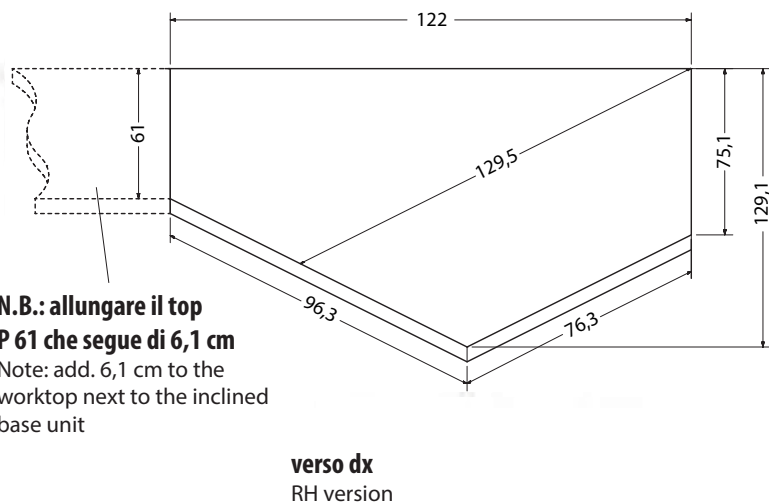





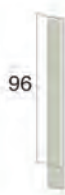

COD.	BRIDGE MELAMINICO KT1	BRIDGE LACCATO KT2	BRIDGE WOOD KT0	HEAD MELAMINICO KT8	HEAD LACCATO KT9	HEAD WOOD KT7
E4910071/2	250	299	427	250	299	453
opz.002	+40	+40	+40	+40	+40	+40
122x129,1 lamin.bordo ABS1						
H 4 T9062631/2						
122x129,1 laminato Fenix NTM						
H 2 TFEN2691/2	VEDI	VEDI	VEDI	VEDI	VEDI	VEDI
H 4 TFEN4691/2	LISTINO	LISTINO	LISTINO	LISTINO	LISTINO	LISTINO
	TOP	TOP	TOP	TOP	TOP	TOP
122x129,1 quarzo pasta piena profilo P						
H 2 TQRP2691/2						
fascia "A"	VEDI	VEDI	VEDI	VEDI	VEDI	VEDI
fascia "B"	LISTINO	LISTINO	LISTINO	LISTINO	LISTINO	LISTINO
fascia "C"	TOP	TOP	TOP	TOP	TOP	TOP
H 3 TQRP3691/2						
fascia "A"	VEDI	VEDI	VEDI	VEDI	VEDI	VEDI
fascia "B"	LISTINO	LISTINO	LISTINO	LISTINO	LISTINO	LISTINO
fascia "C"	TOP	TOP	TOP	TOP	TOP	TOP
Foro rettangolare	T9FRE					
122x129,1 quarzo bordo quarzo profilo P						
H 4 TQRP4691/2						
fascia "A"	VEDI	VEDI	VEDI	VEDI	VEDI	VEDI
fascia "B"	LISTINO	LISTINO	LISTINO	LISTINO	LISTINO	LISTINO
fascia "C"	TOP	TOP	TOP	TOP	TOP	TOP
Foro rettangolare	T9FRE					

COLONNE H 109

COLUMNS H 109



P 59,5

Le colonne non sono comprensive di top - N.B.: cerniere ammortizzate di serie The columns do not include the tops - Note: standard blumotion hinges		COD.	BRIDGE MELAMI- NICO KT1	BRIDGE LACCATO KT2	BRIDGE WOOD KT0	HEAD MELAMI- NICO KT8	HEAD LACCATO KT9	HEAD WOOD KT7	
 <p>fascia tamponamento da 5 a 15 N.B.: la fascia è realizzata senza maniglia per la versione Head filler panel size from 5 to 15 Note: panel realized without handle for Head version</p>									
	in nobilitato melamine coated	E6000010	50	50	50	50	50	50	
	come anta con supporto same as door with support	E6000140	72	89	108	72	89	108	
 <p>1 anta 1 door</p>									
	L 30	E6040301/2	164	177	205	175	189	217	
	L 40	E6040401/2	178	195	228	192	209	245	
	L 45	E6040451/2	184	201	238	198	216	255	
	L 60	E6040601/2	209	233	283	227	252	305	
 <p>2 ante 2 ripiani con tirante centrale 2 doors 2 shelves with central tie beam</p>									
	L 90	E6041900	286	320	401	316	352	437	
 <p>1 anta vetro apertura push-pull N.B.: anta senza maniglia 1 glass door push-pull opening Note: door without handle</p>									
	telaio alluminio L 45 aluminium frame	E6047451/2	298	298	298	298	298	298	
	telaio melaminico L 45 melamine frame	E6046451/2	323	—	—	323	—	—	
 <p>2 ante vetro apertura push-pull N.B.: ante senza maniglia 2 glass doors push-pull opening Note: doors without handle</p>									
	telaio alluminio L 90 aluminium frame	E6047900	520	520	520	520	519	519	
	telaio melaminico L 90 melamine frame	E6046900	574	—	—	574	—	—	
 <p>1 cassetto H 24 2 cestoni H 36 1 drawer H 24 2 deep drawers H 36</p>									
	L 60	E6031620	353	374	462	401	427	529	

COLONNE H 109

COLUMNS H 109

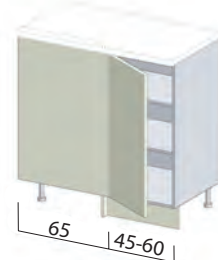
P 59,5







Le colonne non sono comprensive di top - N.B.: cerniere ammortizzate di serie The columns do not include the tops - Note: standard blumotion hinges		COD.	BRIDGE MELAMI- NICO KT1	BRIDGE LACCATO KT2	BRIDGE WOOD KT0	HEAD MELAMI- NICO KT8	HEAD LACCATO KT9	HEAD WOOD KT7	
 <p>predisposta per lavastoviglie Electrolux KESC 5300L - AEG FSE63307P configured for Electrolux KESC 5300L - AEG FSE63307P dishwasher</p>	L 60	E6570600	245	282	348	292	317	393	
	 <p>angolo 2 ripiani con tirante centrale 1 anta (cerniere a pilastro) pannello come anta corner unit 2 shelves with central tie beam 1 door (pillar hinges) panel as door</p> <p>65 45-60</p>	L 110	E6327101/2	331	372	489	353	395	515
L 125		E6327251/2	340	384	530	373	404	560	
 <p>jolly colonna L da 10 a 30 jolly column size from 10 to 30</p> <p>colore come struttura same colour as carcass</p> <p>melaminico come anta melamine same as door</p> <p>impiallacciato come anta (folding) veneered same as door (folding)</p>			E6000900	190	190	190	190	190	190
		E6000930	228	—	—	228	—	—	—
		E6005052	—	—	691	—	—	691	—

BRIDGE-HEAD
COLONNE
COLUMNS

COLONNE H 145

COLUMNS H 145







P 59,5

Le colonne non sono comprensive di top - N.B.: cerniere ammortizzate di serie The columns units do not include the tops - Note: standard blumotion hinges		COD.	BRIDGE MELAMI- NICO KT1	BRIDGE LACCATO KT2	BRIDGE WOOD KT0	HEAD MELAMI- NICO KT8	HEAD LACCATO KT9	HEAD WOOD KT7	
 <p>fascia tamponamento da 5 a 15 N.B.: la fascia è realizzata senza maniglia per la versione Head filler panel size from 5 to 15 Note: panel realized without handle for Head version</p>									
	in nobilitato melamine coated	E6000020	51	51	51	51	51	51	
	come anta con supporto same as door with support	E6000150	77	97	124	77	97	124	
 <p>1 anta 1 door</p>									
	L 30	E6050301/2	191	209	243	203	221	254	
	L 45	E6050451/2	215	241	295	230	257	313	
	L 60	E6050601/2	240	273	348	257	292	370	
 <p>2 ante 2 ripiani con tirante centrale 2 doors 2 shelves with central tie beam</p>									
	L 90	E6050900	348	400	509	378	431	545	
 <p>1 anta vetro apertura push-pull N.B.: anta senza maniglia 1 glass door push-pull opening Note: door without handle</p>									
	telaio alluminio L 45 aluminium frame	E6182451/2	328	328	328	328	328	328	
	L 60	E6182601/2	377	377	377	377	377	377	
	telaio melaminico L 45 melamine frame	E6180451/2	373	—	—	373	—	—	
	L 60	E6180601/2	394	—	—	394	—	—	
 <p>2 ante vetro apertura push-pull N.B.: ante senza maniglia 2 glass doors push-pull opening Note: doors without handle</p>									
	telaio alluminio L 90 aluminium frame	E6182900	580	580	580	580	580	580	
	telaio melaminico L 90 melamine frame	E6180900	669	—	—	669	—	—	
 <p>1 anta integrata al gruppo cestelli estraibili in filo orion grau chiusura soft 1 door incorporated into the orion grau wire pull-out basket units soft-closing system</p>									
	L 30	E6150300	433	451	590	450	467	602	

COLONNE H 145

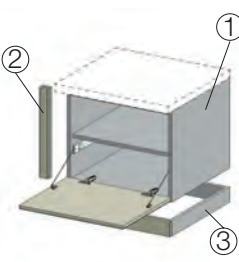
COLUMNS H 145







P 59,5

Le colonne non sono comprensive di top - N.B.: cerniere ammortizzate di serie The columns units do not include the tops - Note: standard blumotion hinges		COD.	BRIDGE MELAMI- NICO KT1	BRIDGE LACCATO KT2	BRIDGE WOOD KT0	HEAD MELAMI- NICO KT8	HEAD LACCATO KT9	HEAD WOOD KT7	
 <p>1 anta gruppo cestelli estraibili in filo orion grau chiusura soft 1 door orion grau wire pull-out basket units soft-closing system</p>	L 45	E6150451/2	465	487	613	477	503	631	
	L 60	E6150601/2	504	534	717	519	556	739	
 <p>1 anta vetro apertura push-pull gruppo cestelli estraibili in filo orion grau chiusura soft N.B.: anta senza maniglia 1 glass door push-pull opening orion grau wire pull-out basket units soft-closing system Note: door without handle</p>	telaio alluminio L 45 aluminium frame	E6152461/2	591	591	591	591	591	591	
	L 60	E6152611/2	658	658	658	658	658	658	
	telaio melaminico L 45 melamine frame	E6152451/2	637	—	—	637	—	—	
	L 60	E6152601/2	676	—	—	676	—	—	
 <p>mobile H 60 L 65 apertura a vasistas push-pull con fascia di tamponamento laterale e inferiore in appoggio su base angolo unit H 60 W 65 flap door push-pull opening with lateral and lower filler panel resting on corser base unit</p> <p>verso SX LH version</p>	1. elemento H 48 L 60 unit H 48 W 60	E2520600	256	269	308	256	269	317	
	2. fascia laterale H 48 L 5 lateral filler panel H 48 W 5	E278000A	51	57	64	51	57	64	
	3. fascia inferiore H 12 L 65 lower filler panel H 12 W 65	E2882000	59	64	77	59	64	77	
 <p>Esempio di mobile in appoggio su base angolo con colonna H 132 affiancata Example of unit resting on corser base unit with side by side column H 132</p> <p>verso SX LH version</p>									
 <p>angolo 2 ripiani con tirante centrale 1 anta (cerniere a pilastro) pannello come anta corner unit 2 shelves with central tie beam 1 door (hinges pillar) panel as door</p> <p>65 45-60</p>	L 110	E6336101/2	382	441	599	405	465	626	
	L 125	E6336251/2	393	453	644	425	478	674	
 <p>jolly colonna L da 10 a 30 jolly column size from 10 to 30</p>	colore come struttura same colour as carcass	E6001000	218	218	218	218	218	218	
	melaminico come anta melamine same as door	E6001030	284	—	—	284	—	—	
	impiallacciato come anta (folding) veneered same as door (folding)	E6005102	—	—	881	—	—	881	

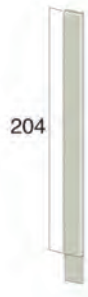
COLONNE H 217

COLUMNS H 217







P 33 - 59,5

N.B.: cerniere ammortizzate di serie Note: standard blumotion hinges		COD.	BRIDGE	BRIDGE	BRIDGE	HEAD	HEAD	HEAD	
			MELAMI- NICO KT1	LACCATO KT2	WOOD KT0	MELAMI- NICO KT8	LACCATO KT9	WOOD KT7	
 <p>fascia tamponamento da 5 a 15 filler panel size from 5 to 15</p> <p>204</p>	<p>in nobilitato melamine coated</p> <p>come anta con supporto same as door with support</p>	E6000050	58	58	58	58	58	58	
		E6000200	87	111	159	87	111	159	
 <p>2 ante anta superiore H 72 anta inferiore H 132 2 doors upper door H 72 lower door H 132</p>	<p>L 45 P 33</p> <p>L 60 P 33</p>	E601345A1/2	259	301	408	290	332	445	
		E601360A1/2	295	351	493	334	391	539	
 <p>2 ante anta superiore H 72 anta inferiore H 132 2 doors upper door H 72 lower door H 132</p>	<p>L 30 P 59,5</p> <p>L 45 P 59,5</p> <p>L 60 P 59,5</p> <p>L 75 P 59,5</p>	E606030A1/2	275	304	367	300	330	390	
		E606345A1/2	309	351	438	340	383	474	
		E606360A1/2	354	410	533	392	449	579	
		E606375A1/2	537	602	654	584	615	683	
 <p>2 ante anta superiore H 132 anta inferiore H 72 2 doors upper door H 132 lower door H 72</p>	<p>L 45 P 33</p> <p>L 60 P 33</p>	E601045A1/2	259	301	408	290	332	445	
		E601060A1/2	295	351	493	334	391	539	
 <p>2 ante anta superiore H 132 anta inferiore H 72 2 doors upper door H 132 lower door H 72</p>	<p>L 45 P 59,5</p> <p>L 60 P 59,5</p> <p>L 75 P 59,5</p>	E606045A1/2	309	351	438	340	383	474	
		E606060A1/2	354	410	533	392	449	579	
		E606075A1/2	537	602	654	584	615	683	
 <p>4 ante 2 ante superiori H 132 2 ante inferiori H 72 4 ripiani con tirante centrale 4 doors 2 upper doors H 132 2 lower doors H 72 4 shelves with central tie beam</p>	<p>L 90 P 59,5</p>	E606090A0	494	576	762	555	637	834	

COLONNE H 217

COLUMNS H 217







P 33 - 59,5

N.B.: cassetti e cestoni ad estrazione totale con blumotion Note: fully extending drawers and deep drawers with blumotion system		COD.	BRIDGE	BRIDGE	BRIDGE	HEAD	HEAD	HEAD	
			MELAMI- NICO KT1	LACCATO KT2	WOOD KT0	MELAMI- NICO KT8	LACCATO KT9	WOOD KT7	
 <p>portascope 2 ante anta superiore H 72 anta inferiore H 132 broom cabinet 2 doors upper door H 72 lower door H 132</p>	L 30 P 59,5	E610030A1/2	273	303	366	298	328	389	
	L 45 P 59,5	E610045A1/2	301	342	430	332	374	466	
	L 60 P 59,5	E610060A1/2	365	420	554	403	460	600	
 <p>portascope con ripiani 2 ante anta superiore H 72 anta inferiore H 132 broom cabinet with shelves 2 doors upper door H 72 lower door H 132</p>	L 45 P 59,5	E6065451/2	461	502	642	533	575	733	
	L 60 P 59,5	E6065601/2	503	557	730	590	645	842	
	L 45 P 59,5	E6065461/2	421	461	592	478	519	664	
 <p>1 anta H 132 4 cassetti H 18 1 door H 132 4 drawers H 18</p>	L 45 P 59,5	E6065461/2	421	461	592	478	519	664	
	L 60 P 59,5	E6065611/2	460	512	677	529	583	766	
	L 45 P 59,5	E6066451/2	380	419	542	423	463	595	
 <p>1 anta H 132 2 cassetti H 18 1 cestone H 36 1 door H 132 2 drawers H 18 1 deep drawer H 36</p>	L 45 P 59,5	E6066451/2	380	419	542	423	463	595	
	L 60 P 59,5	E6066601/2	416	468	624	468	521	690	
	L 45 P 59,5	E6066451/2	380	419	542	423	463	595	
 <p>1 anta H 132 2 cestoni H 36 1 door H 132 2 deep drawers H 36</p>	L 45 P 59,5	E6066451/2	380	419	542	423	463	595	
	L 60 P 59,5	E6066601/2	416	468	624	468	521	690	
	L 45 P 59,5	E6066451/2	380	419	542	423	463	595	
 <p>2 ante anta vetro H 132 apertura push-pull anta chiusa H 72 2 doors glass door H 132 push-pull opening full door H 72</p>	telaio alluminio L 45 P 33 aluminium frame	E6205451/2	367	378	436	379	393	456	
	L 60 P 33	E6205601/2	422	438	495	438	456	518	
	telaio melaminico L 45 P 33 melamine frame	E6202451/2	411	—	—	426	—	—	
	L 60 P 33	E6202601/2	436	—	—	454	—	—	
	L 45 P 33	E6202451/2	411	—	—	426	—	—	

COLONNE H 217

COLUMNS H 217







P 33 - 59,5

N.B.: cassetti e cestoni ad estrazione totale con blumotion Note: fully extending drawers and deep drawers with blumotion system		COD.	BRIDGE	BRIDGE	BRIDGE	HEAD	HEAD	HEAD	
			MELAMI- NICO KT1	LACCATO KT2	WOOD KT0	MELAMI- NICO KT8	LACCATO KT9	WOOD KT7	
 <p>2 ante anta vetro H 132 apertura push-pull anta chiusa H 72 2 doors glass door H 132 push-pull opening full door H 72</p>	telaio alluminio L 45 P 59,5 aluminium frame	E6204451/2	412	424	464	424	438	473	
	L 60 P 59,5	E6204601/2	473	489	530	488	507	554	
	telaio melaminico L 45 P 59,5 melamine frame	E6201451/2	456	—	—	471	—	—	
	L 60 P 59,5	E6201601/2	487	—	—	505	—	—	
 <p>2 ante vetro apertura push-pull anta superiore H 132 anta inferiore H 72 N.B.: ante senza maniglia 2 glass doors push-pull opening upper door H 132 lower door H 72 Note: doors without handle</p>	telaio alluminio L 45 P 33 aluminium frame	E6203461/2	464	464	464	464	464	464	
	L 60 P 33	E6203611/2	538	538	538	538	538	538	
	telaio melaminico L 45 P 33 melamine frame	E6200461/2	560	—	—	560	—	—	
	L 60 P 33	E6200611/2	597	—	—	597	—	—	
 <p>2 ante vetro apertura push-pull anta superiore H 132 anta inferiore H 72 N.B.: ante senza maniglia 2 glass doors push-pull opening upper door H 132 lower door H 72 Note: doors without handle</p>	telaio alluminio L 45 P 59,5 aluminium frame	E6203451/2	509	509	509	509	506	509	
	L 60 P 59,5	E6203601/2	589	589	589	589	589	589	
	telaio melaminico L 45 P 59,5 melamine frame	E6200451/2	607	—	—	607	—	—	
	L 60 P 59,5	E6200601/2	647	—	—	647	—	—	
 <p>4 ante 2 ante vetro H 132 apertura push-pull 2 ante chiuse H 72 4 doors 2 glass doors H 132 push-pull opening 2 full doors H 72</p>	telaio alluminio L 90 P 59,5 aluminium frame	E6204900	731	756	838	757	785	877	
	telaio melaminico L 90 P 59,5 melamine frame	E6201900	820	—	—	851	—	—	
 <p>1 anta vetro H 132 apertura push-pull 4 cassetti H 18 1 glass door H 132 push-pull opening 4 drawers H 18</p>	telaio alluminio L 45 P 59,5 polymeric frame	E6287451/2	588	604	677	645	662	759	
	L 60 P 59,5	E6287601/2	660	681	755	729	752	855	
	telaio melaminico L 45 P 59,5 aluminium frame	E6284451/2	633	—	—	692	—	—	
	L 60 P 59,5	E6284601/2	675	—	—	746	—	—	
 <p>1 anta vetro H 132 apertura push-pull 2 cassetti H 18 1 cestone H 36 1 glass door H 132 push-pull opening 2 drawers H 18 1 deep drawer H 36</p>	telaio alluminio L 45 P 59,5 aluminium frame	E6287461/2	548	562	627	590	606	691	
	L 60 P 59,5	E6287611/2	616	635	700	667	688	777	
	telaio melaminico L 45 P 59,5 melamine frame	E6284461/2	593	—	—	637	—	—	
	L 60 P 59,5	E6284611/2	632	—	—	685	—	—	

COLONNE H 217

COLUMNS H 217







P 59,5

N.B.: cassetti e cestoni ad estrazione totale con blumotion Note: fully extending drawers and deep drawers with blumotion system		COD.	BRIDGE	BRIDGE	BRIDGE	HEAD	HEAD	HEAD	
			MELAMI- NICO KT1	LACCATO KT2	WOOD KT0	MELAMI- NICO KT8	LACCATO KT9	WOOD KT7	
 <p>1 anta vetro H 132 apertura push-pull 2 cestoni H 36 1 glass door H 132 push-pull opening 2 deep drawers H 36</p>	<p>telaio alluminio L 45 aluminium frame</p> <p>L 60</p> <p>telaio melaminico L 45 melamine frame</p> <p>L 60</p>	E6288451/2	508	521	577	535	550	622	
		E6288601/2	574	592	650	607	627	703	
		E6285451/2	552	—	—	582	—	—	
		E6285601/2	587	—	—	623	—	—	
 <p>1 anta H 204 1 door H 204</p>	<p>L 45</p> <p>L 60</p>	E6061451/2	304	345	428	—	—	—	
		E6061601/2	327	403	543	367	423	567	
 <p>portascope 1 anta H 204 broom cabinet 1 door H 204</p>	<p>L 45</p>	E6100461/2	285	325	417	—	—	—	
		E6100611/2	348	424	562	389	444	586	
 <p>portascope con ripiani 1 anta H 204 broom cabinet with shelves 1 door H 204</p>	<p>L 60</p>	E6100611/2	348	424	562	389	444	586	
		E6163300	575	601	783	—	—	—	
 <p>anta H 204 integrata al gruppo cestelli estraibili in filo orion grau chiusura soft door H 204 incorporated into the orion grau wire pull-out basket unit soft-closing system</p>	<p>L 30</p> <p>L 45</p>	E6163450	629	667	886	—	—	—	
		E616030A1/2	513	540	711	536	564	734	
 <p>1 anta superiore H 72 1 anta H 132 integrata al gruppo cestelli estraibili in filo orion grau chiusura soft 1 upper door H 72 1 door H 132 incorporated into the orion grau wire pull-out basket unit soft-closing system</p>	<p>L 30</p>	E616030A1/2	513	540	711	536	564	734	

COLONNE H 241

COLUMNS H 241







P 33 - 59,5

N.B.: cerniere ammortizzate di serie Note: standard blumotion hinges		COD.	BRIDGE	BRIDGE	BRIDGE	HEAD	HEAD	HEAD	
			MELAMI- NICO KT1	LACCATO KT2	WOOD KT0	MELAMI- NICO KT8	LACCATO KT9	WOOD KT7	
 <p>fascia tamponamento da 5 a 15 filler panel size from 5 to 15</p> <p>228</p>									
	in nobilitato melamine coated	E6000100	58	58	58	58	58	58	
	come anta con supporto same as door with support	E6000250	88	114	167	88	114	167	
 <p>2 ante anta superiore H 96 anta inferiore H 132 2 doors upper door H 96 lower door H 132</p>									
	L 45 P 33	E602345A1/2	315	359	452	346	391	488	
	L 60 P 33	E602360A1/2	360	423	550	399	462	596	
 <p>2 ante anta superiore H 96 anta inferiore H 132 2 doors upper door H 96 lower door H 132</p>									
	L 30 P 59,5	E607030A1/2	301	333	401	326	359	424	
	L 45 P 59,5	E607345A1/2	340	384	482	371	416	519	
	L 60 P 59,5	E607360A1/2	394	456	592	432	496	639	
 <p>2 ante anta superiore H 156 anta inferiore H 72 2 doors upper door H 156 lower door H 72</p>									
	L 45 P 33	E602045A1/2	315	361	452	346	393	488	
	L 60 P 33	E602060A1/2	356	418	546	395	458	592	
 <p>2 ante anta superiore H 156 anta inferiore H 72 2 doors upper door H 156 lower door H 72</p>									
	L 45 P 59,5	E607045A1/2	340	386	482	371	418	519	
	L 60 P 59,5	E607060A1/2	390	452	588	428	491	634	
 <p>4 ante 2 ante superiori H 156 2 ante inferiori H 72 4 ripiani con tirante centrale 4 doors 2 upper doors H 156 2 lower doors H 72 4 shelves with central tie beam</p>									
	L 90 P 59,5	E607090A0	541	631	838	601	692	909	

COLONNE H 241

COLUMNS H 241







P 33 - 59,5

N.B.: cassetti e cestoni ad estrazione totale con blumotion Note: fully extending drawers and deep drawers with blumotion system		COD.	BRIDGE	BRIDGE	BRIDGE	HEAD	HEAD	HEAD	
			MELAMI- NICO KT1	LACCATO KT2	WOOD KT0	MELAMI- NICO KT8	LACCATO KT9	WOOD KT7	
 <p>portascope 1 anta superiore H 96 1 anta inferiore H 132 broom cabinet 1 upper door H 96 1 lower door H 132</p>	L 30 P 59,5	E611030A1/2	300	333	392	325	358	415	
	L 45 P 59,5	E611045A1/2	331	375	475	362	407	511	
 <p>portascope con ripiani 1 anta superiore H 96 1 anta inferiore H 132 broom cabinet with shelves 1 upper door H 96 1 lower door H 132</p>	L 60 P 59,5	E611060A1/2	390	452	601	429	492	647	
 <p>1 anta H 156 4 cassetti H 18 1 door H 156 4 drawers H 18</p>	L 45 P 59,5	E6075451/2	488	534	684	560	607	775	
	L 60 P 59,5	E6075601/2	534	594	780	622	682	892	
 <p>1 anta H 156 2 cassetti H 18 1 cestone H 36 1 door H 156 2 drawers H 18 1 deep drawer H 36</p>	L 45 P 59,5	E6075461/2	448	493	634	505	551	706	
	L 60 P 59,5	E6075611/2	491	549	728	561	620	816	
 <p>1 anta H 156 2 cestoni H 36 1 door H 156 2 deep drawers H 36</p>	L 45 P 59,5	E6076451/2	407	451	584	450	495	637	
	L 60 P 59,5	E6076601/2	448	505	675	500	558	740	
 <p>2 ante vetro apertura push-pull anta superiore H 156 anta inferiore H 72 N.B.: ante senza maniglia 2 glass doors push-pull opening upper door H 156 lower door H 72 Note: doors without handle</p>	telaio alluminio L 45 P 33 aluminium frame	E6213461/2	543	543	543	543	543	543	
	telaio melaminico L 45 P 33 melamine frame	E6210461/2	627	—	—	627	—	—	

COLONNE H 241

COLUMNS H 241





P 33 - 59,5

N.B.: cassetti e cestoni ad estrazione totale con blumotion Note: fully extending drawers and deep drawers with blumotion system		COD.	BRIDGE MELAMI- NICO KT1	BRIDGE LACCATO KT2	BRIDGE WOOD KT0	HEAD MELAMI- NICO KT8	HEAD LACCATO KT9	HEAD WOOD KT7
 <p>2 ante vetro apertura push-pull anta superiore H 156 anta inferiore H 72 N.B.: ante senza maniglia 2 glass doors push-pull opening upper door H 156 lower door H 72 Note: doors without handle</p>	<p>telaio alluminio L 45 P 59,5 aluminium frame</p>	E6213451/2	562	562	562	562	562	562
	<p>telaio melaminico L 45 P 59,5 melamine frame</p>	E6210451/2	650	—	—	650	—	—
 <p>2 ante anta vetro H 156 apertura push-pull anta chiusa H 72 2 doors glass door H 156 push-pull opening full door H 72</p>	<p>telaio alluminio L 45 P 33 aluminium frame</p>	E6215451/2	443	455	487	456	470	506
	<p>telaio melaminico L 45 P 33 melamine frame</p>	E6212451/2	477	—	—	492	—	—
 <p>2 ante anta vetro H 156 apertura push-pull anta chiusa H 72 2 doors glass door H 156 push-pull opening full door H 72</p>	<p>telaio alluminio L 45 P 59,5 aluminium frame</p>	E6214451/2	466	478	516	479	493	535
	<p>telaio melaminico L 45 P 59,5 melamine frame</p>	E6211451/2	499	—	—	514	—	—
 <p>4 ante 2 ante vetro H 156 apertura push-pull 2 ante chiuse H 72 4 doors 2 glass doors H 156 push-pull opening 2 full doors H 72</p>	<p>telaio alluminio L 90 P 59,5 aluminium frame</p>	E6214900	829	854	930	854	883	969
	<p>telaio melaminico L 90 P 59,5 melamine frame</p>	E6211900	894	—	—	926	—	—
 <p>1 anta vetro H 156 apertura push-pull 4 cassetti H 18 1 glass door H 156 push-pull opening 4 drawers H 18</p>	<p>telaio alluminio L 45 P 59,5 aluminium frame</p>	E6297451/2	643	658	738	699	716	811
	<p>telaio melaminico L 45 P 59,5 melamine frame</p>	E6294451/2	676	—	—	735	—	—
 <p>1 anta vetro H 156 apertura push-pull 2 cassetti H 18 1 cestone H 36 1 glass door H 156 push-pull opening 2 drawers H 18 1 deep drawer H 36</p>	<p>telaio alluminio L 45 P 59,5 aluminium frame</p>	E6297461/2	602	617	688	644	660	743
	<p>telaio melaminico L 45 P 59,5 melamine frame</p>	E6294461/2	634	—	—	680	—	—

COLONNE H 241

COLUMNS H 241

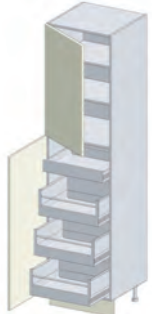
P 59,5

N.B.: cassetti e cestoni ad estrazione totale con blumotion Note: fully extending drawers and deep drawers with blumotion system		COD.	BRIDGE MELAMI- NICO KT1	BRIDGE LACCATO KT2	BRIDGE WOOD KT0	HEAD MELAMI- NICO KT8	HEAD LACCATO KT9	HEAD WOOD KT7	
 <p>1 anta vetro H 156 apertura push-pull 2 cestoni H 36 1 glass door H 156 push-pull opening 2 deep drawers H 36</p>									
	<p>telaio alluminio L 45 aluminium frame</p>	E6298451/2	562	575	639	589	604	674	
	<p>telaio melaminico L 45 melamine frame</p>	E6295451/2	595	—	—	625	—	—	
 <p>1 anta superiore H 96 1 anta H 132 integrata al gruppo cestelli estraibili in filo orion grau chiusura soft 1 upper door H 96 1 door H 132 incorporated into the orion grau wire pull-out basket units soft-closing system</p>									
	L 30	E617030A1/2	537	567	736	560	591	759	
 <p>1 anta superiore H 96 1 anta inferiore H 132 gruppo cestelli estraibili in filo orion grau chiusura soft 1 upper door H 96 1 lower door H 132 orion grau wire pull-out basket units soft-closing system</p>									
	L 45	E617045A1/2	583	626	797	611	653	833	
	L 60	E617060A1/2	641	698	941	676	733	985	
 <p>1 anta superiore H 96 (cerniere 100°) 1 anta inferiore H 132 (cerniere 180°) 1 cassetto interno 3 cestoni interni posizionare sempre a 5 cm dalla parete laterale 1 upper door H 96 (100° hinges) 1 lower door H 132 (180° hinges) 1 internal drawer 3 internal deep drawers should always be placed at 5 cm from the side wall</p>									
	L 45	E608848A1/2	581	614	767	601	643	802	
 <p>jolly colonna L da 15 a 30 jolly column size from 15 to 30</p>									
		colore come struttura same colour as carcass	E6003000	307	307	307	307	307	307
		melaminico come anta melamine same as door	E6003030	414	—	—	414	—	—
	impiallacciato come anta (folding) veneered same as door (folding)	E6005252	—	—	1.406	—	—	1.406	



COLONNE ANGOLO H 241

P 59,5

CORNER COLUMNS H 241

N.B.: cerniere ammortizzate di serie





Note: standard blumotion hinges

	COD.	BRIDGE MELAMI- NICO KT1	BRIDGE LACCATO KT2	BRIDGE WOOD KT0	HEAD MELAMI- NICO KT8	HEAD LACCATO KT9	HEAD WOOD KT7	
 <p>angolo 5 ripiani con tirante centrale 1 anta superiore H 96 1 anta inferiore H 132 (cerniere a pilastro) pannello come anta corner unit 5 shelves with central tie beam 1 upper door H 96 1 lower door H 132 (pillar hinges) panel as door</p>	L 110	E6316101/2	586	686	959	623	724	1.002
	L 125	E6316251/2	600	696	1.042	643	741	1.094
 <p>angolo 1 anta H 228 (156+72) cerniere 135° 2 fianchi sp. 3,8 come struttura N.B.: fornita smontata corner 1 door H 228 (156+72) 135° hinges 2 side panels Th.3,8 same as carcass Note: supplied unassembled</p>	105,5x105,5	E6342051/2	1.032	1.130	1.202	1.086	1.145	1.220

COLONNE PER FORNO H 109

P 59,5

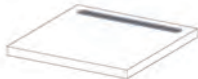
OVEN COLUMNS H 109







Le colonne non sono comprensive di top - N.B.: cassetti e cestoni ad estrazione totale con blumotion The columns do not include the tops - Note: fully extending drawers and deep drawers with blumotion system		COD.	BRIDGE MELAMI- NICO KT1	BRIDGE LACCATO KT2	BRIDGE WOOD KT0	HEAD MELAMI- NICO KT8	HEAD LACCATO KT9	HEAD WOOD KT7		
 <p>colonna H 109 per forno 2 cassetti H 18 oven column H 109 2 drawers H 18</p>	L 60	E6501660	265	276	315	300	311	361		
	 <p>colonna H 109 per forno 1 cassetto H 12 1 cassetto H 24 oven column H 109 1 drawer H 12 1 drawer H 24</p>	L 60	E6501650	287	294	326	318	329	372	
 <p>colonna H 109 per forno 1 cestone chiuso H 36 oven column H 109 1 full deep drawer H 36</p>		L 60	E6501600	221	231	262	239	248	284	
	 <p>top H 1,8 come anta P 59,6 per colonne worktop H 1,8 same as door D 59,6 for columns</p>									
			melaminico al ml melamine per lm	TLE186	77	—	—	77	—	—
			laccato al ml lacquered per lm	TLC196	—	96	—	—	96	—
			impiallacciato al ml veneered per lm	TLH186W	—	—	136	—	—	136
			mag.griglia di areazione cad. surcharge for ventilation grille each	T9FGA	30	30	30	30	30	30
 <p>profilo in acciaio a "L" per rifinire il ripiano del forno e microonde L-shaped steel finishing profile for shelf of oven and microwave</p>	L 60									
		inox stainless steel	08660100	9	9	9	9	9	9	
		nero black	08660101	9	9	9	9	9	9	
		bianco white	08660102	9	9	9	9	9	9	
 <p>kit protezione fianchi per forno protection kit sides for oven</p>	L 90									
		inox stainless steel	08660105	12	12	12	12	12	12	
	coppia couple	08630095	16	16	16	16	16	16		

COLONNE PER FORNO H 145

P 59,5

OVEN COLUMNS H 145

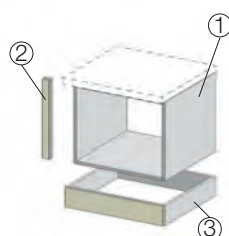
Le colonne non sono comprensive di top - N.B.: cerniere ammortizzate di serie
The columns do not include the tops - Note: standard blumotion hinges







	COD.	BRIDGE MELAMI- NICO KT1	BRIDGE LACCATO KT2	BRIDGE WOOD KT0	HEAD MELAMI- NICO KT8	HEAD LACCATO KT9	HEAD WOOD KT7	
 <p>colonna H 145 per forno 1 anta H 72 oven column H 145 1 door H 72</p>	L 60	E6520601/2	217	237	283	244	263	305
	L 75	E6520751/2	251	274	331	291	306	353
 <p>colonna H 145 per forno 4 cassetti H 18 oven column H 145 4 drawers H 18</p>	L 60	E6521610	402	427	512	472	495	602
	L 60	E6521620	359	379	459	411	432	526
 <p>colonna H 145 per forno 2 cassetti H 18 1 cestone H 36 oven column H 145 2 drawers H 18 1 deep drawer H 36</p>	L 60	E6521630	319	338	409	354	373	453
	L 60	E6521630	319	338	409	354	373	453
 <p>colonna H 145 per forno 2 cestoni H 36 oven column H 145 2 deep drawers H 36</p>	L 60	E6521630	319	338	409	354	373	453
	L 60	E6521630	319	338	409	354	373	453
 <p>colonna H 145 per forno per maxiforno H 48 1 cassetto H 18 2 ante H 60 oven column H 145 for maxi-oven H 48 1 drawer H 18 2 doors H 60</p>	L 90	E6521910	362	397	491	414	451	550
	L 90	E6521910	362	397	491	414	451	550
 <p>mobile H 60 L 65 per micro con fascia di tamponamento laterale e inferiore in appoggio su base angolo unit H 60 W 65 flap door push-pull opening with lateral and lower filler panel resting on corser base unit</p> <p>verso SX LH version</p>								
		E2521600	121	121	121	121	121	121
		E278000B	51	57	64	51	57	64
	E2882100	59	64	77	59	64	77	
 <p>Esempio di mobile per micro in appoggio su base angolo con colonna H 132 affiancata Example of micro unit resting on corser base unit with side by side column H 132</p> <p>verso SX LH version</p>								

COLONNE PER FORNO H 217

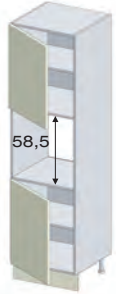
P 59,5

OVEN COLUMNS H 217



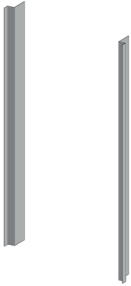



N.B.: cassetti e cestoni ad estrazione totale con blumotion
 Note: fully extending drawers and deep drawers with blumotion system

	COD.	BRIDGE MELAMI- NICO KT1	BRIDGE LACCATO KT2	BRIDGE WOOD KT0	HEAD MELAMI- NICO KT8	HEAD LACCATO KT9	HEAD WOOD KT7	
 <p>colonna per forno 1 anta superiore H 72 1 anta inferiore H 72 oven column 1 upper door H 72 1 lower door H 72</p>	L 60	E653060A1/2	324	362	452	369	407	496
	L 75	E653075A1/2	380	426	541	424	470	585
 <p>colonna per forno 1 anta H 72 4 cassetti H 18 oven column 1 door H 72 4 drawers H 18</p>	L 60	E6531611/2	523	563	697	611	652	810
	L 60	E6531621/2	480	518	644	550	589	733
 <p>colonna per forno 1 anta H 72 2 cassetti H 18 1 cestone H 36 oven column 1 door H 72 2 drawers H 18 1 deep drawer H 36</p>	L 60	E6531631/2	436	474	591	489	527	657
	L 60	E6531631/2	436	474	591	489	527	657
 <p>profilo in acciaio a "L" per rifinire il ripiano del forno e microonde L-shaped steel finishing profile for shelf of oven and microwave</p> 	L 60							
	inox	08660100	9	9	9	9	9	9
	nero	08660101	9	9	9	9	9	9
	bianco	08660102	9	9	9	9	9	9
 <p>kit protezione fianchi per forno protection kit sides for oven</p> 	coppia	08630095	16	16	16	16	16	16
	couple	08630095	16	16	16	16	16	16

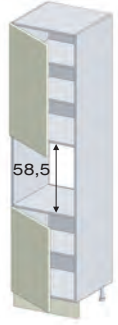
COLONNE PER FORNO H 241

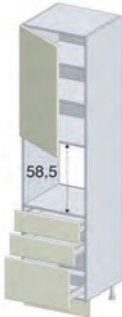
P 59,5

OVEN COLUMNS H 241

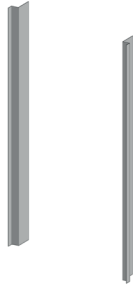
N.B.: cassetti e cestoni ad estrazione totale con blumotion Note: fully extending drawers and deep drawers with blumotion system		COD.	BRIDGE MELAMI- NICO KT1	BRIDGE LACCATO KT2	BRIDGE WOOD KT0	HEAD MELAMI- NICO KT8	HEAD LACCATO KT9	HEAD WOOD KT7	
 <p>colonna per forno 1 anta superiore H 96 1 anta inferiore H 72 oven column 1 upper door H 96 1 lower door H 72</p>									
	L 60	E654060A1/2	362	407	509	408	452	553	
 <p>colonna per forno 1 anta H 96 4 cassetti H 18 oven column 1 door H 96 4 drawers H 18</p>									
	L 60	E6541611/2	560	606	741	648	695	853	
 <p>colonna per forno 1 anta superiore H 96 2 cassetti H 18 1 cestone H 36 oven column 1 upper door H 96 2 drawers H 18 1 deep drawer H 36</p>									
	L 60	E6541621/2	517	561	688	587	632	777	
 <p>colonna per forno 1 anta superiore H 96 2 cestoni H 36 oven column 1 upper door H 96 2 deep drawers H 36</p>									
	L 60	E6541631/2	473	516	634	526	570	700	
 <p>profilo in acciaio a "L" per rifinire il ripiano del forno e microonde L-shaped steel finishing profile for shelf of oven and microwave</p> 									
	L 60								
	inox stainless steel	08660100	9	9	9	9	9	9	
	nero black	08660101	9	9	9	9	9	9	
bianco white	08660102	9	9	9	9	9	9		
 <p>kit protezione fianchi per forno protection kit sides for oven</p> 									
	coppia couple	08630095	16	16	16	16	16	16	

COLONNE PER FORNO H 241

P 59,5

OVEN COLUMNS H 241

N.B.: cassetti e cestoni ad estrazione totale con blumotion
 Note: fully extending drawers and deep drawers with blumotion system

COD.	BRIDGE MELAMI- NICO KT1	BRIDGE LACCATO KT2	BRIDGE WOOD KT0	HEAD MELAMI- NICO KT8	HEAD LACCATO KT9	HEAD WOOD KT7
------	----------------------------------	--------------------------	-----------------------	--------------------------------	------------------------	---------------------

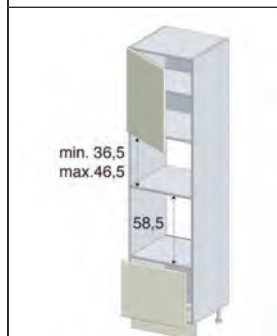

colonna per forno e micro
1 anta superiore a misura
vano micro da H 36,5 a 46,5
1 cestone H 48
 oven and microwave column
 1 upper door made to size
 microwave compartment H 36,5 to 46,5
 1 deep drawer H 48

L 60	E6561611/2	428	438	503	463	469	534
------	------------	-----	-----	-----	-----	-----	-----



colonna per forno
1 anta superiore H 72
1 anta H 48 sollevamento verticale
1 cestone H 48
 oven column
 1 upper door H 72
 1 door H 48 vertical opening
 1 deep drawer H 48

L 60	E656460A1/2	583	635	731	645	690	797
------	-------------	-----	-----	-----	-----	-----	-----



colonna per forno e lavastoviglie
Electrolux KESC 5300L - AEG FSE63307P
1 anta superiore H 72
1 anta lavastoviglie H 72
1 cassetto H 24
 column for oven and Electrolux KESC 5300L -
 AEG FSE63307P dishwasher
 1 upper door H 72
 1 dishwasher door H 72
 1 drawer H 24

L 60	E6575601/2	405	460	570	469	513	636
------	------------	-----	-----	-----	-----	-----	-----

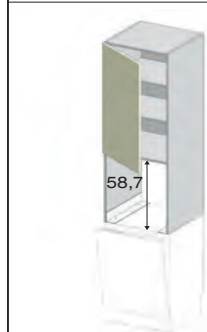

colonna forno sospesa H 156 per lavastoviglie
1 anta H 96
 hanging oven column H 156 for dishwasher
 1 door H 96

L 60	E6577601/2	310	344	385	337	366	407
------	------------	-----	-----	-----	-----	-----	-----



fianco per colonna sospesa a fine
composizione
 side panel for hanging column placed at the end of the
 composition

H 241x59,6x1,8 zoccolo H 13
come anta
 same as door

T94386	112	—	307	112	—	307
--------	-----	---	-----	-----	---	-----





H 241x59,7x1,9 zoccolo H 13
laccato come anta
 lacquered same as door

T94387	—	169	—	—	169	—
--------	---	-----	---	---	-----	---

COLONNE PER FRIGO H 145 - 217

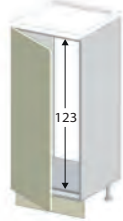
P 59,5

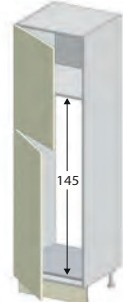
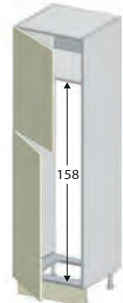

FRIDGE COLUMNS H 145 - 217

Le colonne non sono comprensive di top The columns do not include the tops		COD.	BRIDGE MELAMI- NICO KT1	BRIDGE LACCATO KT2	BRIDGE WOOD KT0	HEAD MELAMI- NICO KT8	HEAD LACCATO KT9	HEAD WOOD KT7	
 <p>colonna H 145 per frigo 215 monoporta column H 145 for single-door fridge 215</p>		L 60	E6452151/2	258	292	367	276	311	389
 <p>colonna H 217 per frigo 215 monoporta 1 anta superiore H 72 1 anta inferiore H 132 column H 217 for 215 single-door fridge 1 upper door H 72 1 lower door H 132</p>		L 60	E646215A1/2	331	387	504	370	426	549
 <p>colonna H 217 per frigo-freezer 230 1 anta superiore H 84 1 anta inferiore H 120 column H 217 for 230 fridge-freezer 1 upper door H 84 1 lower door H 120</p>		L 60	E646231A1/2	331	387	504	370	426	549
 <p>colonna H 217 per frigo-freezer 280 1 anta superiore H 84 1 anta inferiore H 120 column H 217 for 280 fridge-freezer 1 upper door H 84 1 lower door H 120</p>		L 60	E646286A1/2	331	387	504	370	426	549
 <p>colonna H 217 per frigo-congelatore 315 1 anta superiore H 132 1 anta inferiore H 72 column H 217 for 315 fridge-freezer 1 upper door H 132 1 lower door H 72</p>		L 60	E646315A1/2	331	387	504	370	426	549
 <p>colonna H 217 per frigo-congelatore 315 1 anta superiore H 24 1 anta centrale H 108 1 anta inferiore H 72 column H 217 for 315 fridge-freezer 1 upper door H 24 1 central door H 108 1 lower door H 72</p>		L 60	E6463161/2	357	414	528	415	473	663

COLONNE PER FRIGO H 217

FRIDGE COLUMNS H 217

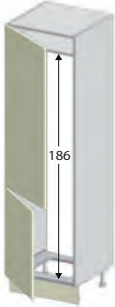
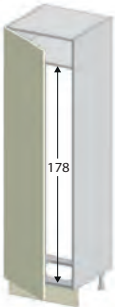
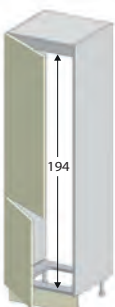





P 59,5

	COD.	BRIDGE MELAMI- NICO KT1	BRIDGE LACCATO KT2	BRIDGE WOOD KT0	HEAD MELAMI- NICO KT8	HEAD LACCATO KT9	HEAD WOOD KT7		
 <p>colonna H 217 per frigo-congelatore 330 1 anta superiore H 132 1 anta inferiore H 72 column H 217 for 330 fridge-freezer 1 upper door H 132 1 lower door H 72</p>	L 60	E646330A1/2	331	387	504	370	426	549	
	 <p>colonna H 217 per frigo-freezer 300 monoporta 1 anta H 204 column H 217 for 300 single-door fridge-freezer 1 door H 204</p>	L 60	E6463001/2	331	387	504	370	426	549
 <p>colonna H 217 per frigo-congelatore 350 1 anta superiore H 132 1 anta inferiore H 72 column H 217 for 350 fridge-freezer 1 upper door H 132 1 lower door H 72</p>		L 60	E646351A1/2	331	387	504	370	426	549
	 <p>colonna H 217 per frigo-congelatore 400 1 anta superiore H 132 1 anta inferiore H 72 column H 217 for 400 fridge-freezer 1 upper door H 132 1 lower door H 72</p>	L 75	E646400A1/2	457	522	615	504	570	660

COLONNE PER FRIGO H 241

FRIDGE COLUMNS H 241



P 59,5

	COD.	BRIDGE MELAMI- NICO KT1	BRIDGE LACCATO KT2	BRIDGE WOOD KT0	HEAD MELAMI- NICO KT8	HEAD LACCATO KT9	HEAD WOOD KT7		
 <p>colonna H 241 per frigo 215 monoporta 1 anta superiore H 96 1 anta inferiore H 132 column H 241 for 215 single-door fridge 1 upper door H 96 1 lower door H 132</p>	L 60	E647215A1/2	352	413	543	390	452	589	
	 <p>colonna H 241 per frigo-freezer 230 1 anta superiore H 108 1 anta inferiore H 120 column H 241 for 230 fridge-freezer 1 upper door H 108 1 lower door H 120</p>	L 60	E647231A1/2	352	413	543	390	452	589
 <p>colonna H 241 per frigo-freezer 280 1 anta superiore H 108 1 anta inferiore H 120 column H 241 for 280 fridge-freezer 1 upper door H 108 1 lower door H 120</p>		L 60	E647286A1/2	352	413	543	390	452	589
	 <p>colonna H 241 per frigo-congelatore 315 1 anta superiore H 156 1 anta inferiore H 72 column H 241 for 315 fridge-freezer 1 upper door H 156 1 lower door H 72</p>	L 60	E647315A1/2	352	413	543	390	452	589
 <p>colonna H 241 per frigo-congelatore 315 1 anta superiore H 48 1 anta centrale H 108 1 anta inferiore H 72 column H 241 for 315 fridge-freezer 1 upper door H 48 1 central door H 108 1 lower door H 72</p>		L 60	E6473161/2	378	441	570	435	499	638
	 <p>colonna H 241 per frigo-congelatore 330 1 anta superiore H 156 1 anta inferiore H 72 column H 241 for 330 fridge-freezer 1 upper door H 156 1 lower door H 72</p>	L 60	E647330A1/2	352	413	543	390	452	589

COLONNE PER FRIGO H 241

FRIDGE COLUMNS H 241

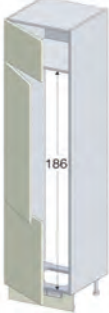
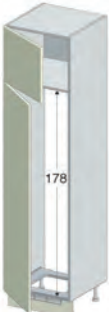

P 59,5

	COD.	BRIDGE MELAMI- NICO KT1	BRIDGE LACCATO KT2	BRIDGE WOOD KT0	HEAD MELAMI- NICO KT8	HEAD LACCATO KT9	HEAD WOOD KT7	
 <p>colonna H 241 per frigo-congelatore 330 1 anta superiore H 36 1 anta centrale H 120 1 anta inferiore H 72 column H 241 for 330 fridge-freezer 1 upper door H 36 1 central door H 120 1 lower door H 72</p>	L 60	E6473361/2	378	441	570	435	499	638
	 <p>colonna H 241 per frigo-congelatore 300 monoporta 1 anta superiore H 48 1 anta inferiore H 180 column H 241 for 300 single-door fridge-freezer 1 upper door H 48 1 lower door H 180</p>	L 60	E647300A1/2	352	413	543	390	452
 <p>colonna H 241 per frigo-congelatore 350 1 anta superiore H 156 1 anta inferiore H 72 column H 241 for 350 fridge-freezer 1 upper door H 156 1 lower door H 72</p>		L 60	E647351A1/2	352	413	543	390	452
	 <p>colonna H 241 per frigo-congelatore 400 1 anta superiore a ribalta H 24 TIP-ON 1 anta centrale H 132 1 anta inferiore H 72 column H 241 for 400 fridge-freezer 1 upper flap door H 24 TIP-ON opening 1 central door H 132 1 lower door H 72</p>	L 75	E6474101/2	587	661	768	644	718

SOPRACOLONNE

TOP COLUMNS

P 59,9

		COD.	BRIDGE MELAMI- NICO KT1	BRIDGE LACCATO KT2	BRIDGE WOOD KT0	HEAD MELAMI- NICO KT8	HEAD LACCATO KT9	HEAD WOOD KT7		
 <p>sopracolonna 1 anta top column 1 door</p>	H 36 L 30	EC601301/2	141	142	150	145	158	161		
	L 45	EC601451/2	131	139	155	146	154	173		
	L 60	EC601601/2	144	155	174	163	174	196		
	ribalta TIP-ON L 75	EC61076T	230	246	272	230	246	272		
	H 48 L 30	EC602301/2	176	180	175	190	199	187		
	L 45	EC602451/2	169	180	187	185	195	204		
	L 60	EC602601/2	186	200	211	205	218	234		
	ribalta TIP-ON L 75	EC61276T	275	295	319	275	295	319		
	 <p>sopracolonna 1 anta vetro top column 1 glass door</p>	telaio alluminio H 36 L 45	EC605461/2	208	208	208	208	208	208	
		L 60	EC605611/2	231	231	231	231	231	231	
H 48 L 45		EC606461/2	236	236	236	236	236	236		
L 60		EC606611/2	291	291	291	291	291	291		
telaio melaminico H 36 L 45		EC605451/2	233	—	—	233	—	—		
L 60		EC605601/2	264	—	—	264	—	—		
H 48 L 45		EC606451/2	263	—	—	263	—	—		
L 60		EC606601/2	326	—	—	326	—	—		
 <p>fianco per colonna side panel for column</p>	fianco side panel									
	H 239,7x59,6x1,8	T94384	112	—	304	112	—	304		
	H 239,7x59,7x1,9	T94385	—	169	—	—	169	—		
	H 251,7x59,6x1,8	T94390	120	—	317	120	—	317		
	H 251,7x59,7x1,9	T94391	—	176	—	—	176	—		

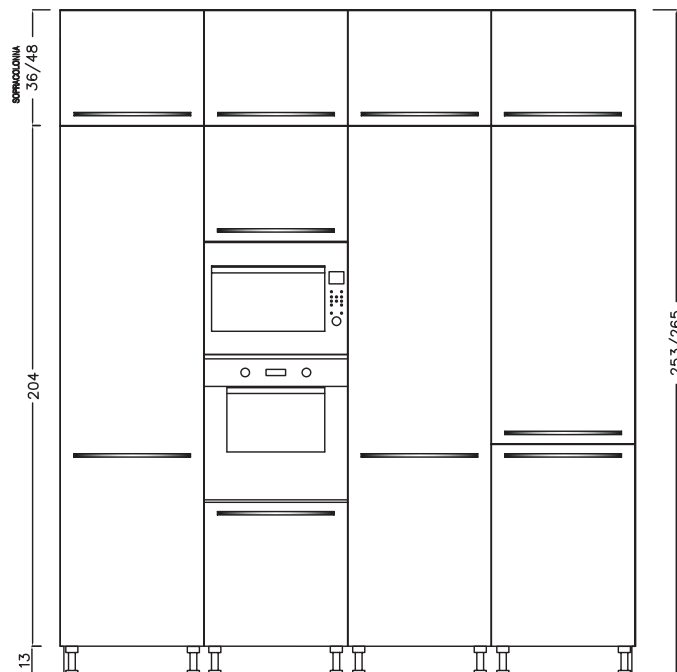

SOPRACOLONNE PER SISTEMA PONTE

P 59,5

TOP COLUMNS FOR BRIDGE SYSTEM

N.B.: il sistema a ponte può essere realizzato solo tra due colonne
 Note: the bridge system realized only between 2 columns

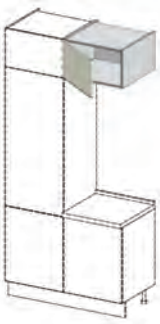
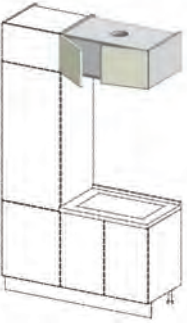
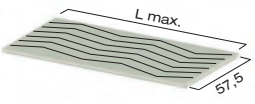
	COD.	BRIDGE MELAMI- NICO KT1	BRIDGE LACCATO KT2	BRIDGE WOOD KT0	HEAD MELAMI- NICO KT8	HEAD LACCATO KT9	HEAD WOOD KT7		
<p>sopracolonna per sistema ponte 1 anta top column for bridge system 1 door</p> 	H 36 L 45	EC601461/2	131	140	155	146	154	173	
	L 60	EC601611/2	145	156	174	163	174	196	
	2 ante L 90	EC601910	191	207	236	228	242	271	
	H 48 L 45	EC602461/2	170	180	199	185	195	216	
	L 60	EC602611/2	187	200	224	205	218	234	
	2 ante L 90	EC602910	214	234	274	239	258	309	
	sopracolonna per sistema ponte 1 anta vetro top column for bridge system 1 door								
	telaio alluminio H 36 L 45	EC605471/2	222	222	222	222	222	222	
	L 60	EC605621/2	241	241	241	241	241	241	
2 ante L 90	EC605920	367	367	367	367	367	367		
H 48 L 45	EC606471/2	260	260	260	260	260	260		
L 60	EC606621/2	316	316	316	316	316	316		
2 ante L 90	EC606920	468	468	468	468	468	468		
telaio melaminico H 36 L 45	EC601471/2	233	—	—	233	—	—		
L 60	EC601621/2	259	—	—	259	—	—		
2 ante L 90	EC601920	393	—	—	393	—	—		
H 48 L 45	EC602471/2	276	—	—	276	—	—		
L 60	EC602621/2	308	—	—	308	—	—		
2 ante L 90	EC602920	429	—	—	429	—	—		
<p>cappa aspirante integrata totale con luce led e comando remoto, 2 ante - L 90 portata 696 m³/h classe energetica A - L 120 portata 730 m³/h classe energetica B (depuratore fornito smontato) fully integrated extractor hood with bar led and remote control, 2 doors - W 90 air flow rate 696 m³/h energetic class A - W 120 air flow rate 730 m³/h energetic class B (purifier supplied unassembled)</p> 	H 36 L 90	EPC00900	1.297	1.312	1.335	1.332	1.348	1.370	
	L 120	EPC01200	1.656	1.676	1.719	1.701	1.720	1.762	
	H 48 L 90	EPC01900	1.326	1.346	1.378	1.361	1.381	1.414	
	L 120	EPC02200	1.687	1.713	1.770	1.732	1.757	1.814	
	pannello di finitura come anta sp.1,8 venature orizzontali finishing panel same as door th.1,8 horizontal grains								
	L.max 275 melaminico max.lenght 275 melamine	094506	121	—	—	121	—	—	
	L.max 275 laccato max.lenght 275 lacquered	094529	—	171	—	—	171	—	
	L.max 275 impiallacciato max.lenght 275 veneered	094520W	—	—	214	—	—	214	

tablet **B**ridge **H**ead



Con lo **zoccolo** ad altezza ridotta a **6 cm**, si possono **guadagnare centimetri preziosi di contenimento**, dando alla cucina l'aspetto elegante di un living.

Valuable space has been saved by lowering the plinth to 6 cm, and so the kitchen will take on a stylish look such as a living room.



tablet **B**ridge Head

strutture carcasses



bianco (opz.001)
schiena e ripiano bianco
(opz.001)
white
white back panel and shelf

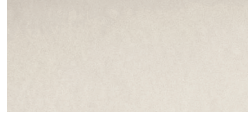

conchiglia (opz.8910)
schiena e ripiano conchiglia
(opz.8910)
shell
shell back panel and shelf



lavagna (opz.9620)
schiena e ripiano lavagna
(opz.9620)
slate grey
slate grey back panel and shelf



fango (opz.8860)
schiena e ripiano fango
(opz.8860)
mud
mud back panel and shelf



visone (opz.948M)
schiena e ripiano visone
(opz.948M)
mink
mink back panel and shelf



argilla (opz.9690)
schiena e ripiano argilla
(opz.9690)
clay (opt.9690)
clay back panel and shelf
(opt.9690)

zoccoli in alluminio H 6 aluminium plinths H 6

di serie
standard



alluminio finitura
brill (opz.412)
aluminium brill finish
(opt.412)



alluminio finitura titanio
ossidato (opz.414)
aluminium titanium
oxidized finish (opt.414)

zoccoli in alluminio H 6 verniciati a polvere finitura opaca aluminum plinths H 6 powder coated matt finish

magg. rispetto allo zoccolo standard
surcharges compared to standard plinth



alluminio finitura
bianco assoluto
(opz.740S)
aluminium absolute
white finish (opt.740S)



alluminio finitura
grigio selce (opz.SE)
aluminium flint grey
finish (opt.SE)



alluminio finitura
silver dark (opz.9507)
aluminium dark silver
finish (opt.9507)



alluminio finitura
ghisa (opz.9509)
aluminium cast iron
finish (opt.9509)

al ml
per lm
cod.092085
code
+35 €

angolare
angular
cod.0923903
code
+4 €



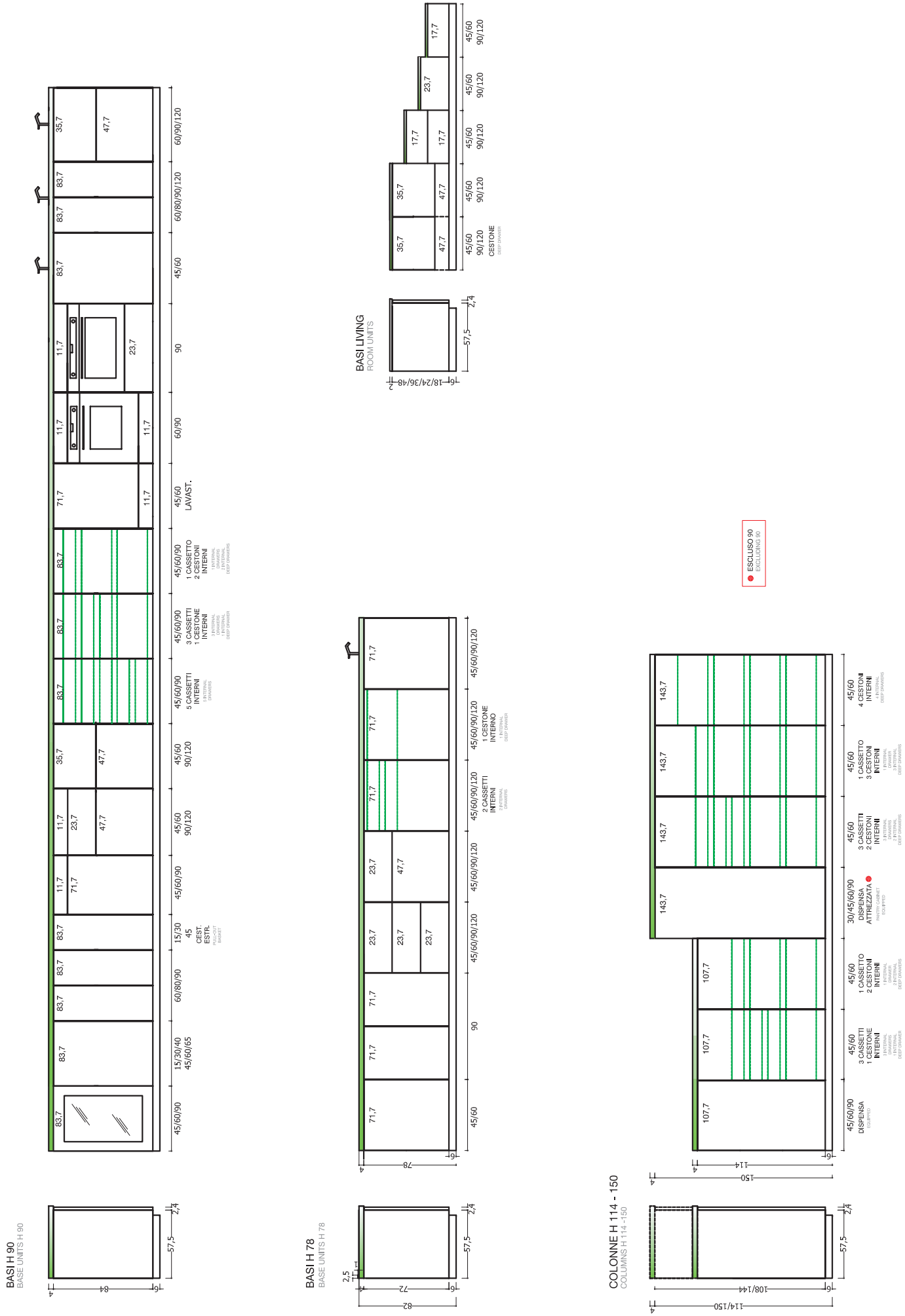



MODULARITÀ E COMPONIBILITÀ MODULARITY AND FITTING SOLUTIONS



BASI CON ZOCCOLO H 6

BASE UNITS WITH PLINTH H 6





H 90 P 61

LE BASI NON SONO COMPRENSIVE DI TOP/N.B.: cassetti e cestoni con blumotion THE BASE UNITS DO NOT INCLUDE THE TOPS/Note: drawers and deep drawers with blumotion system		COD.	BRIDGE MELAMI- NICO KT1	BRIDGE LACCATO KT2	BRIDGE WOOD KT0	HEAD MELAMI- NICO KT8	HEAD LACCATO KT9	HEAD WOOD KT7	
 <p>fascia tamponamento filler panel</p>									
	L da 3 a 15 size from 3 to 15	EB800000	78	80	87	98	100	87	
 <p>jolly base L da 15 a 30 jolly base unit size from 15 to 30</p>									
	colore come struttura same colour as carcass	EB700000	150	150	150	150	150	150	
	melaminico come anta melamine same as door	EB700030	224	—	—	224	—	—	
	impiallacciato come anta (folding) veneered same as door (folding)	EB730020	—	—	640	—	—	640	
 <p>1 anta H 84 1 door H 84</p>									
	L 15	EB010151/2	133	140	159	148	156	170	
	L 30	EB010301/2	153	165	186	170	180	197	
	L 40	EB010401/2	171	180	210	192	201	227	
	L 45	EB010451/2	180	190	225	202	215	243	
	L 60	EB010601/2	212	225	271	235	250	293	
	L 65	EB010651/2	228	243	287	253	268	306	
 <p>2 ante H 84 2 doors H 84</p>									
	L 60	EB010600	236	252	295	271	287	317	
	L 80	EB010800	273	290	344	315	338	378	
	L 90	EB010900	294	320	381	339	365	416	
 <p>cestello estraibile chiusura soft pull-out basket unit soft-closing system</p>									
	L 15	EB150150	169	178	178	184	192	189	
	L 30	EB150300	217	225	249	234	245	260	
	L 45	EB150450	244	260	288	266	284	306	
 <p>1 cassetto H 12 1 anta H 72 1 drawer H 12 1 door H 72</p>									
	L 45	EB021451/2	251	261	287	296	305	323	
	L 60	EB021601/2	278	290	326	325	338	370	
	L 90	EB021900	377	395	458	444	465	517	

BASI CON ZOCCOLO H 6

H 90 P 61

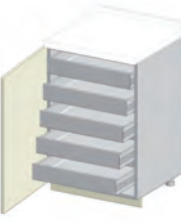
BASE UNITS WITH PLINTH H 6

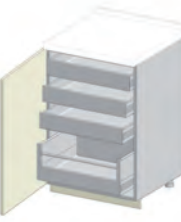
LE BASI NON SONO COMPRENSIVE DI TOP/N.B.: cassetti e cestoni con blumotion THE BASE UNITS DO NOT INCLUDE THE TOPS/Note: drawers and deep drawers with blumotion system		COD.	BRIDGE	BRIDGE	BRIDGE	HEAD	HEAD	HEAD	
			MELAMI- NICO KT1	LACCATO KT2	WOOD KT0	MELAMI- NICO KT8	LACCATO KT9	WOOD KT7	
 <p> 1 cassetto H 12 1 cassetto H 24 1 cestone H 48 1 drawer H 12 1 drawer H 24 1 deep drawer H 48 </p>	L 45	EB131450	373	383	407	441	460	461	
	L 60	EB131600	409	419	450	480	494	517	
	L 90	EB131900	504	529	554	571	599	624	
	L 120	EB132200	612	638	—	701	732	—	
 <p> 2 cassetti H 12 2 cassetti H 24 1 cestone H 48 2 drawers H 12 2 drawers H 24 1 deep drawer H 48 </p>	L 90	EB300900	636	691	759	752	805	855	
 <p> 1 cestone H 36 superiore 1 cestone H 48 inferiore 1 upper deep drawer H 36 1 lower deep drawer H 48 </p>	L 45	EB171450	318	335	341	364	382	376	
	L 60	EB171600	345	368	386	393	418	430	
	L 90	EB171900	424	455	481	469	501	527	
	L 120	EB172200	508	537	—	567	598	—	
 <p> 1 anta H 84 5 cassetti interni Posizionare a 5 cm dalla parete laterale 1 door H 84 5 internal drawers Place at 5 cm from the side wall </p>	L 45	EB236451/2	515	536	527	538	559	545	
	L 60	EB236601/2	575	599	599	599	628	621	
 <p> 2 ante H 84 5 cassetti interni posizionare a 5 cm dalla parete laterale 2 doors H 84 5 internal drawers place at 5 cm from the side wall </p>	L 90	EB236900	716	752	763	761	801	798	
 <p> 1 anta H 84 3 cassetti interni 1 cestone interno posizionare a 5 cm dalla parete laterale 1 door H 84 3 internal drawers 1 internal deep drawer place at 5 cm from the side wall </p>	L 45	EB236461/2	503	529	489	526	552	507	
	L 60	EB236611/2	558	587	557	582	612	579	

BASI CON ZOCCOLO H 6

H 90 P 61

BASE UNITS WITH PLINTH H 6

LE BASI NON SONO COMPRENSIVE DI TOP/N.B.: cassetti e cestoni con blumotion
 THE BASE UNITS DO NOT INCLUDE THE TOPS/Note: drawers and deep drawers with blumotion system

COD.

BRIDGE
MELAMI-
NICO
KT1

BRIDGE
LACCATO
KT2

BRIDGE
WOOD
KT0

HEAD
MELAMI-
NICO
KT8

HEAD
LACCATO
KT9

HEAD
WOOD
KT7



2 ante H 84
3 cassetti interni
1 cestone interno
 posizionare a 5 cm dalla parete laterale
 2 doors H 84
 3 internal drawers
 1 internal deep drawer
 place at 5 cm from the side wall

L 90

EB236910

636

695

711

700

741

746



1 anta H 84
1 cassetto interno
2 cestoni interni
 posizionare a 5 cm dalla parete laterale
 1 door H 84
 1 internal drawer
 2 internal deep drawers
 place at 5 cm from the side wall

L 45

EB236471/2

476

501

447

499

525

465

L 60

EB236621/2

527

555

511

551

580

533



2 ante H 84
1 cassetto interno
2 cestoni interni
 posizionare a 5 cm dalla parete laterale
 2 doors H 84
 1 internal drawer
 2 internal deep drawers
 place at 5 cm from the side wall

L 90

EB236920

644

685

657

690

732

692

BASI ANGOLO CON ZOCCOLO H 6

H 90 P 65



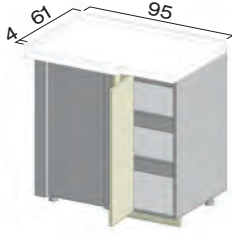
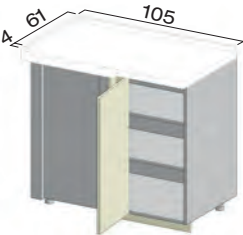
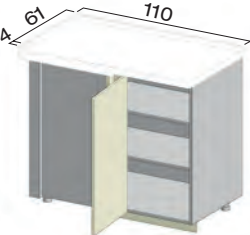
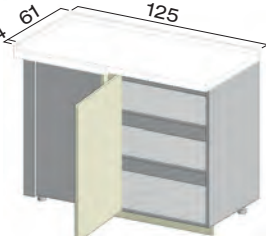
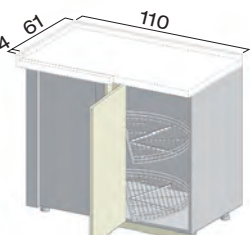
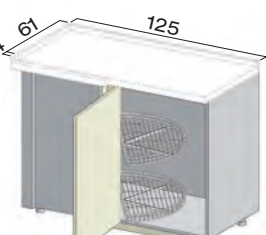

CORNER BASE UNITS WITH PLINTH H 6

LE BASI NON SONO COMPRENSIVE DI TOP THE BASE UNITS DO NOT INCLUDE THE TOPS		COD.	BRIDGE MELAMI- NICO KT1	BRIDGE LACCATO KT2	BRIDGE WOOD KT0	HEAD MELAMI- NICO KT8	HEAD LACCATO KT9	HEAD WOOD KT7	
 <p>angolo L 95 2 ripiani 1 anta L 30 H 84 cassone 90 corner unit W 95 2 shelves 1 door W 30 H 84 structure 90</p> <p>verso dx RH version</p>	95x65	EB400951/2	350	366	356	361	380	368	
 <p>angolo L 105 2 ripiani 1 anta L 40 H 84 cassone 90 corner unit W 105 2 shelves 1 door W 40 H 84 structure 90</p> <p>verso dx RH version</p>	105x65	EB401041/2	361	378	372	375	391	389	
 <p>angolo L 110 2 ripiani 1 anta L 45 H 84 cassone 105 corner unit W 110 2 shelves 1 door W 45 H 84 structure 105</p> <p>verso dx RH version</p>	110x65	EB401091/2	381	405	397	397	420	414	
 <p>angolo L 125 2 ripiani 1 anta L 60 H 84 cassone 120 con tirante corner unit W 125 2 shelves 1 door W 60 H 84 structure 120 with tie beam</p> <p>verso dx RH version</p>	125x65	EB401241/2	407	426	471	425	453	493	
 <p>angolo L 110 2 cestelli mezzaluna orion grau 1 anta L 45 H 84 cassone 105 corner unit W 110 2 crescent-shaped orion grau wire basket units 1 door W 45 H 84 structure 105</p> <p>verso dx RH version</p>	110x65	EB401111/2	396	413	412	411	433	430	
 <p>angolo L 125 2 cestelli mezzaluna orion grau 1 anta L 60 H 84 cassone 120 corner unit W 125 2 crescent-shaped orion grau wire basket units 1 door W 60 H 84 structure 120</p> <p>verso dx RH version</p>	125x65	EB401261/2	418	441	452	436	461	473	

BASI ANGOLO CON ZOCCOLO H 6

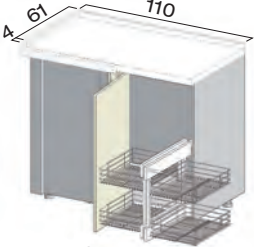
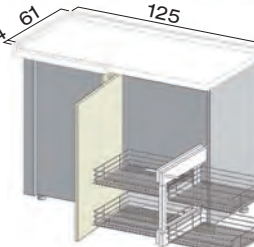
H 90 P 65



CORNER BASE UNITS WITH PLINTH H 6

LE BASI NON SONO COMPRENSIVE DI TOP THE BASE UNITS DO NOT INCLUDE THE TOPS		COD.	BRIDGE MELAMI- NICO KT1	BRIDGE LACCATO KT2	BRIDGE WOOD KT0	HEAD MELAMI- NICO KT8	HEAD LACCATO KT9	HEAD WOOD KT7	
 <p>angolo L 110 4 cestelli orion grau estraibili indipendenti dall'anta 1 anta L 45 H 84 cassone 105 corner unit W 110 4 pull-out orion grau basket units opening independently from door 1 door W 45 H 84 structure 105</p> <p>verso dx RH version</p>									
	110x65	EB451101/2	906	923	902	921	943	920	
 <p>angolo L 125 4 cestelli orion grau estraibili indipendenti dall'anta 1 anta L 60 H 84 cassone 120 corner unit W 125 4 pull-out orion grau basket units opening independently from door 1 door W 60 H 84 structure 120</p> <p>verso dx RH version</p>									
	125x65	EB451251/2	978	1.001	985	996	1.021	1.006	
 <p>angolo 95x95 2 ripiani 2 ante L 30 H 84 (cerniere 180°) angolare unito all'anta dx corner unit 95x95 2 shelves 2 doors W 30 H 84 (180° hinges) angular filler attached to the RH door</p>									
	95x95	EB480950	783	828	706	802	851	729	
 <p>angolo 110x110 2 ripiani 2 ante L 45 H 84 (cerniere 180°) angolare unito all'anta dx corner unit 110x110 2 shelves 2 doors W 45 H 84 (180° hinges) angular filler attached to the RH door</p>									
	110x110	EB481100	1.428	1.469	800	1.458	1.502	837	
 <p>angolo 65x65 con supporto N.B.: solo angolare corner unit 65x65 with support Note: only angular filler</p>									
	65x65	EB480650	132	132	92	153	153	92	
 <p>angolo 65x65 con supporto per inserimento lavastoviglie destra o sinistra N.B.: solo angolare con fianco corner unit 65x65 with support for dishwasher placed on the right or the left side Note: only angular filler with side</p> <p>verso dx RH version</p>									
	65x65	EB480651/2	183	110	119	170	123	119	

BASI ANGOLO CON PANNELLO COME ANTA E ZOCCOLO H 6

H 90 P 61

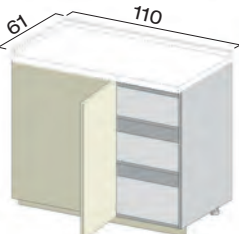
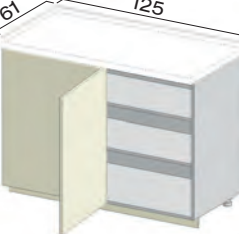
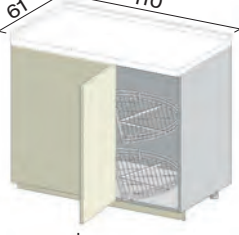
CORNER BASE UNITS WITH FIXED PANEL SAME AS DOOR AND PLINTH H 6

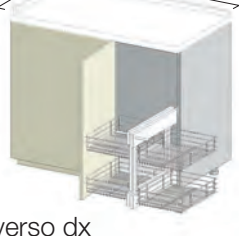
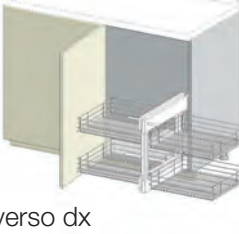
LE BASI NON SONO COMPRENSIVE DI TOP THE BASE UNITS DO NOT INCLUDE THE TOPS		COD.	BRIDGE MELAMI- NICO KT1	BRIDGE LACCATO KT2	BRIDGE WOOD KT0	HEAD MELAMI- NICO KT8	HEAD LACCATO KT9	HEAD WOOD KT7
 <p>angolo L 110 2 ripiani 1 anta L 45 H 84 pannello come anta cassone 110 corner unit W 110 2 shelves 1 door W 45 H 84 panel as door structure 110</p> <p>verso dx RH version</p>	110x61	EB403091/2	379	399	487	436	459	513
	 <p>angolo L 125 2 ripiani 1 anta L 60 H 84 pannello come anta cassone 125 con tirante corner unit W 125 2 shelves 1 door W 60 H 84 panel as door structure 125 with tie beam</p> <p>verso dx RH version</p>	125x61	EB403241/2	404	436	553	461	485
 <p>angolo L 110 2 cestelli mezzaluna orion grau 1 anta L 45 H 84 pannello come anta cassone 110 corner unit W 110 2 crescent-shaped orion grau wire basket units 1 door W 45 H 84 panel as door structure 110</p> <p>verso dx RH version</p>	110x61	EB403111/2	379	411	479	436	459	506
	 <p>angolo L 125 2 cestelli mezzaluna orion grau 1 anta L 60 H 84 pannello come anta cassone 125 corner unit W 125 2 crescent-shaped orion grau wire basket units 1 door W 60 H 84 panel as door structure 125</p> <p>verso dx RH version</p>	125x61	EB403261/2	404	436	512	461	485
 <p>angolo L 110 4 cestelli orion grau estraibili indipendenti dall'anta 1 anta L 45 H 84 pannello come anta cassone 110 corner unit W 110 4 pull-out orion grau basket units opening independently from door 1 door W 45 H 84 panel as door structure 110</p> <p>verso dx RH version</p>	110x61	EB453101/2	889	921	969	946	969	996
	 <p>angolo L 125 4 cestelli orion grau estraibili indipendenti dall'anta 1 anta L 60 H 84 pannello come anta cassone 125 corner unit W 125 4 pull-out orion grau basket units opening independently from door 1 door W 60 H 84 panel as door structure 125</p> <p>verso dx RH version</p>	125x61	EB453251/2	964	996	1.045	1.021	1.045

BASI PER FORNI CON ZOCCOLO H 6

H 90 P 61

OVEN BASE UNITS WITH PLINTH H 6







LE BASI NON SONO COMPRENSIVE DI TOP
THE BASE UNITS DO NOT INCLUDE THE TOPS

	COD.	BRIDGE MELAMI- NICO KT1	BRIDGE LACCATO KT2	BRIDGE WOOD KT0	HEAD MELAMI- NICO KT8	HEAD LACCATO KT9	HEAD WOOD KT7	
 <p>base per forno elettrico H 60 1 frontale superiore fisso H 12 1 cassetto H 12 inferiore N.B.: da utilizzare per top H 2 e per P.C. filo top electric oven base unit H 60 1 fixed upper front H 12 1 lower drawer H 12 Note: to be used in conjunction with tops H 2 and flush hobs</p>	L 60	EF510620	252	255	242	311	312	265
 <p>base per forno elettrico H 60 1 cassetto H 12 superiore 1 cassetto H 12 inferiore electric oven base unit H 60 1 upper drawer H 12 1 lower drawer H 12</p>	L 60	EF510607	325	326	315	373	374	357
 <p>base per maxiforno H 60 1 frontale superiore fisso 1 cassetto H 12 inferiore maxi-oven base unit H 60 1 fixed upper front 1 lower drawer H 12</p>	L 90	EF510908	315	316	308	376	378	331
 <p>base per maxiforno H 60 1 cassetto H 12 superiore 1 cassetto H 12 inferiore maxi-oven base unit H 60 1 upper drawer H 12 1 lower drawer H 12</p>	L 90	EF510907	396	397	376	442	444	415
 <p>base per maxiforno H 46 1 frontale superiore fisso H 12 1 cassetto H 24 inferiore electric maxi-oven base unit H 46 1 fixed upper front H 12 1 lower drawer H 24</p>	L 90	EF510925	332	340	336	394	401	359
 <p>kit raccordo base angolo junction kit corner base unit</p>	110x110	EF471100	145	174	144	168	196	144
 <p>kit raccordo base angolo per inserimento lavastoviglie a destra o sinistra junction kit for corner base unit for dishwasher placed on the right or the left side</p> <p>verso dx RH version</p>	110x110	EF471151/2	184	213	182	206	235	182

BASI PER PIANI COTTURA CON ZOCCOLO H 6

H 90 P 61



COOKER HOB BASE UNITS WITH PLINTH H 6

LE BASI NON SONO COMPRENSIVE DI TOP/N.B.: cassetti e cestoni con blumotion THE BASE UNITS DO NOT INCLUDE THE TOPS/Note: drawers and deep drawers with blumotion system		COD.	BRIDGE MELAMI- NICO KT1	BRIDGE LACCATO KT2	BRIDGE WOOD KT0	HEAD MELAMI- NICO KT8	HEAD LACCATO KT9	HEAD WOOD KT7
 <p>base predisposta piano cottura 1 anta H 84 2 ripiani base unit configured for cooker hob 1 door H 84 2 shelves</p>	L 60	EF500601/2	212	230	271	235	255	293
		opz.101	+55	+55	+55	+55	+55	+55
 <p>base predisposta piano cottura 2 ante H 84 2 ripiani base unit configured for cooker hob 2 doors H 84 2 shelves</p>	L 90	EF500900	294	322	381	339	368	416
		opz.101	+55	+55	+55	+55	+55	+55
 <p>Maggiorazione per base predisposta piano cottura ad induzione con lamierino di protezione N.B.: realizzabile su base 2 cestoni Surcharge for base unit configured for induction cooker hob with protection metal sheet Note: available on base unit 2 deep drawers</p>		opz.101	+55	+55	+55	+55	+55	+55
 <p>base predisposta piano cottura con cappa integrata 1 frontale superiore fisso H 12 1 cassetto H 24 P 40 1 cestone H 48 P 40 base unit configured for cooker hob with integrated hood 1 fixed upper front H 12 1 drawer H 24 D 40 1 deep drawer H 48 D 40</p>	L 90	EF509090	419	439	487	502	522	533
	L 120	EF509120	496	519	—	597	184	—
 <p>base predisposta piano cottura con cappa integrata 1 anta vasistas H 36 1 cestone H 48 P 40 base unit configured for cooker hob with integrated hood 1 flap door H 36 1 deep drawer H 48 D 40</p>	L 90	EF509095	475	508	572	521	554	618
	L 120	EF509125	558	599	—	617	660	—
 <p>Esempio di piano cottura con cappa integrata Example of cooker hob with integrated hood</p>								

SOTTOLAVELLI CON ZOCCOLO H 6

H 90 P 61

SINK BASE UNITS WITH PLINTH H 6

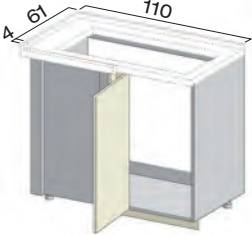
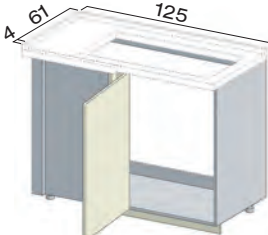
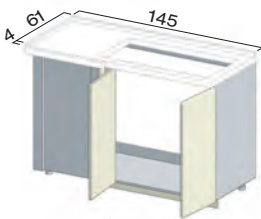
LE BASI NON SONO COMPRENSIVE DI TOP THE BASE UNITS DO NOT INCLUDE THE TOPS		COD.	BRIDGE	BRIDGE	BRIDGE	HEAD	HEAD	HEAD	
			MELAMI- NICO KT1	LACCATO KT2	WOOD KT0	MELAMI- NICO KT8	LACCATO KT9	WOOD KT7	
 <p>sottolavello 1 anta H 84 sink base unit 1 door H 84</p>	L 45	ES010451/2	183	203	213	205	226	231	
	L 60	ES010601/2	209	231	254	232	255	276	
 <p>sottolavello 2 ante H 84 sink base unit 2 doors H 84</p>	L 60	ES010600	231	257	279	266	293	301	
	L 80	ES010800	267	294	325	308	345	358	
	L 90	ES010900	278	315	350	323	360	385	
	L 120	ES011200	337	389	438	386	438	482	
 <p>sottolavello 2 cestoni 1 cestone superiore H 36 sagomato con vaschette 1 cestone inferiore H 48 sink base unit 2 deep drawers 1 contoured upper deep drawer H 36 with trays 1 lower deep drawer H 48</p>	L 60	ES200600	383	407	424	431	457	468	
	L 90	ES200900	452	484	520	497	532	566	
	L 120	ES201200	538	565	—	597	624	—	
 <p>sottolavello angolo L 110 1 anta L 45 H 84 cassone 105 corner sink base unit W 110 1 door W 45 H 84 structure 105</p> <p>verso dx RH version</p>	110x65	ES421101/2	346	366	354	350	370	371	
	 <p>sottolavello angolo L 125 1 anta L 60 H 84 cassone 120 corner sink base unit W 125 1 door W 60 H 84 structure 120</p> <p>verso dx RH version</p>	125x65	ES421251/2	370	392	388	376	408	410
 <p>sottolavello angolo L 145 2 ante L 40 H 84 cassone 140 corner sink base unit W 145 2 doors W 40 H 84 structure 140</p> <p>verso dx RH version</p>		145x65	ES421451/2	427	459	461	451	483	495

SOTTOLAVELLI CON ZOCCOLO H 6

H 90 P 61

SINK BASE UNITS WITH PLINTH H 6

LE BASI NON SONO COMPRENSIVE DI TOP
THE BASE UNITS DO NOT INCLUDE THE TOPS

sottolavello angolo L 155
2 ante L 45 H 84
cassone 150
corner sink base unit W 155
2 doors W 45 H 84
structure 150

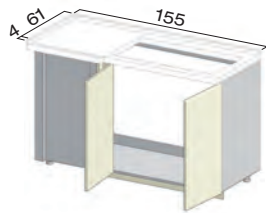

verso dx
RH version

155x65

ES421551/2

442

471

487

469

499

522

sottolavello angolo 95x95
2 ante L 30 H 84 (cerniere 180°)
angolare unito all'anta dx
corner sink base unit 95x95
2 doors W 30 H 84 (180° hinges)
angular filler attached to the RH door

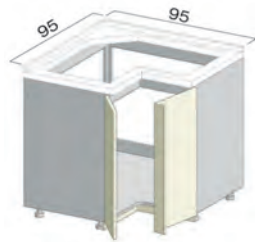

95x95

ES020950

632

663

664

637

684

686

sottolavello angolo 110x110
2 ante L 45 H 84 (cerniere 180°)
angolare unito all'anta dx
corner sink base unit 110x110
2 doors W 45 H 84 (180° hinges)
angular filler attached to the RH door

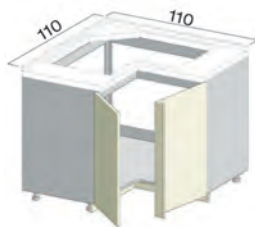

110x110

ES021100

699

737

752

714





758

787

BASI ELETTRODOMESTICI SOTTOTOP ZOCCOLO H 6

H 90 P 61







BASE UNITS FOR UNDER-TOP APPLIANCES WITH PLINTH H 6

LE BASI NON SONO COMPRENSIVE DI TOP THE BASE UNITS DO NOT INCLUDE THE TOPS		COD.	BRIDGE MELAMI- NICO KT1	BRIDGE LACCATO KT2	BRIDGE WOOD KT0	HEAD MELAMI- NICO KT8	HEAD LACCATO KT9	HEAD WOOD KT7	
 <p>anta per lavastoviglie scomparsa totale sliding completa di kit protezione fianchi door for fully integrated dishwasher sliding with protection kit for side panels</p>	L 60	EL490290	220	240	251	232	248	275	
	<p>anta per lavastoviglie scomparsa totale H 72 kit rialzo lavastoviglie con frontale fisso H 12 e piedini H 6 completa di kit protezione fianchi door for fully integrated dishwasher H 72 dishwasher raising kit with fixed lower front H 12 and legs H 6 with protection kit for side panels</p>								
	L 45	EL490080	216	232	209	227	240	218	
	L 60	EL490090	262	266	248	287	297	271	
 <p>kit protezione fianchi per lavastoviglie protection kit for side panels for dishwasher</p> 									
 <p>fianco per lavastoviglie a fine composizione side panel for dishwasher placed at the end of the composition</p>									
		G94605	25	25	25	25	25	25	
		T94708	78	—	125	78	—	125	
		T947081	—	85	—	—	85	—	

BASI E SOTTOLAVELLI H 78 CON ZOCCOLO H 6

H 78 P 61





BASE UNITS AND SINK BASE UNITS H 78 WITH PLINTH H 6

LE BASI NON SONO COMPRENSIVE DI TOP THE BASE UNITS DO NOT INCLUDE THE TOPS		COD.	BRIDGE	BRIDGE	BRIDGE	HEAD	HEAD	HEAD	
			MELAMI- NICO KT1	LACCATO KT2	WOOD KT0	MELAMI- NICO KT8	LACCATO KT9	WOOD KT7	
 <p>base H 78 1 anta H 72 base unit H 78 1 door H 72</p>	L 45	E4010451/2	144	158	198	158	172	216	
	L 60	E4010601/2	159	177	231	177	195	253	
 <p>base H 78 2 ante H 72 base unit H 78 2 doors H 72</p>	L 90	E4010900	218	246	324	247	275	359	
 <p>base H 78 3 cassetti H 24 base unit H 78 3 drawers H 24</p>	L 45	EB250450	390	398	392	459	468	447	
	L 60	EB250600	405	413	425	478	488	492	
	L 90	EB250900	508	530	526	577	599	596	
	L 120	EB251200	610	629	—	701	720	—	
 <p>base H 78 1 cassetto H 24 1 cestone H 48 base unit H 78 1 drawer H 24 1 deep drawer H 48</p>	L 45	EB262450	300	313	314	346	360	350	
	L 60	EB262600	315	333	350	365	381	394	
	L 90	EB262900	398	423	438	443	470	484	
	L 120	EB263200	474	503	—	535	563	—	
 <p>sottolavello H 78 1 anta H 72 sink base unit H 78 1 door H 72</p>	L 45	E5010451/2	142	156	197	156	170	215	
	L 60	E5010601/2	156	174	229	173	191	250	
 <p>sottolavello H 78 2 ante H 72 sink base unit H 78 2 doors H 72</p>	L 90	E5010900	208	236	314	236	265	349	
	L 120	E5011200	240	277	379	275	312	423	
 <p>sottolavello H 78 1 cestone H 72 1 cassetto interno sagomato con vaschette sink base unit H 78 1 deep drawer H 72 1 contoured internal drawer with trays</p>	L 60	E5270600	412	429	456	413	430	478	
	L 90	E5270900	441	466	512	445	470	535	
	L 120	E5271200	469	504	—	527	535	—	

COLONNE H 114 CON ZOCCOLO H 6

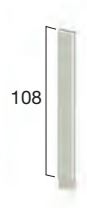
P 59,5



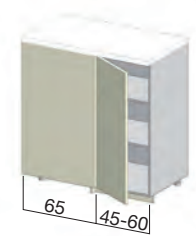



COLUMNS H 114 WITH PLINTH H 6

LE COLONNE NON SONO COMPRENSIVE DI TOP THE COLUMNS DO NOT INCLUDE THE TOPS		COD.	BRIDGE MELAMI- NICO KT1	BRIDGE LACCATO KT2	BRIDGE WOOD KT0	HEAD MELAMI- NICO KT8	HEAD LACCATO KT9	HEAD WOOD KT7	
 <p>fascia tamponamento da 5 a 15 filler panel size from 5 to 15</p>									
	<p>come anta con supporto same as door with support</p>	EC000140	112	113	117	124	129	117	
 <p>1 anta H 108 1 door H 108</p>									
	L 45	EC040451/2	266	277	284	292	303	302	
	L 60	EC040601/2	301	313	333	327	339	355	
 <p>2 ante H 108 2 ripiani con tirante centrale 2 doors H 108 2 shelves with central tie beam</p>									
	L 90	EC041900	421	448	480	472	501	515	
 <p>predisposta per lavastoviglie Electrolux KESC 5300L - AEG FSE63307P anta lavastoviglie H 72 1 cestone H 36 configured for Electrolux KESC 5300L - AEG FSE63307P dishwasher dishwasher door H 72 1 deep drawer H 36</p>									
	L 60	EC570600	352	372	396	400	422	439	
 <p>angolo 2 ripiani con tirante 1 anta H 108 pannello come anta corner unit 2 shelves with tie beam 1 door H 108 panel as door</p>									
	L 110 P 60	EC327101/2	464	486	562	496	521	571	
	L 125 P 60	EC327251/2	480	510	603	514	547	616	

COLONNE H 150 CON ZOCCOLO H 6

P 59,5







COLUMNS H 150 WITH PLINTH H 6

LE COLONNE NON SONO COMPRENSIVE DI TOP THE COLUMNS DO NOT INCLUDE THE TOPS		COD.	BRIDGE MELAMI- NICO KT1	BRIDGE LACCATO KT2	BRIDGE WOOD KT0	HEAD MELAMI- NICO KT8	HEAD LACCATO KT9	HEAD WOOD KT7	
 <p>fascia tamponamento da 5 a 15 filler panel size from 5 to 15</p> <p>144</p>									
	<p>come anta con supporto same as door with support</p>	EC000150	116	130	130	129	146	130	
 <p>1 anta H 144 1 door H 144</p>									
	L 30	EC050301/2	307	317	302	327	340	314	
	L 45	EC050451/2	334	351	363	358	375	381	
	L 60	EC050601/2	376	395	425	403	422	447	
 <p>2 ante H 144 3 ripiani con tirante centrale 2 doors H 144 3 shelves with central tie beam</p>									
	L 90	EC050900	531	561	612	579	611	648	
 <p>1 anta H 144 integrata al gruppo cestelli estraibili in filo orion grau chiusura soft 1 door H 144 incorporated into orion grau wire pull-out basket units soft-closing system</p>									
	L 30	EC150300	580	594	638	599	612	649	
 <p>1 anta H 144 gruppo cestelli estraibili in filo orion grau chiusura soft 1 door H 144 orion grau wire pull-out basket units soft-closing system</p>									
	L 45	EC150451/2	616	638	670	639	651	688	
	L 60	EC150601/2	679	699	782	704	735	804	
 <p>angolo 3 ripiani con tirante 1 anta H 144 pannello come anta corner unit 3 shelves with tie beam 1 door H 144 panel as door</p> <p>65 45-60</p>									
	L 110 P 60	EC336101/2	573	606	699	605	627	725	
	L 125 P 60	EC336251/2	592	630	754	622	660	784	
 <p>jolly colonna L da 10 a 30 jolly column size from 10 to 30</p>									
	<p>colore come struttura same colour as carcass</p> <p>melaminico come anta melamine same as door</p> <p>impiallacciato come anta (folding) veneered same as door (folding)</p>	EC001000	245	245	245	245	245	245	
	EC001030	351	—	—	351	—	—		
	EC005012	—	—	923	—	—	923		

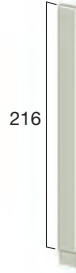
COLONNE H 222 CON ZOCCOLO H 6

COLUMNS H 222 WITH PLINTH H 6





P 59,5

	COD.	BRIDGE MELAMI- NICO KT1	BRIDGE LACCATO KT2	BRIDGE WOOD KT0	HEAD MELAMI- NICO KT8	HEAD LACCATO KT9	HEAD WOOD KT7	
 <p>fascia tamponamento da 5 a 15 filler panel size from 5 to 15</p> <p>216</p>								
 <p>1 anta H 216 1 door H 216</p>								
 <p>2 ante H 216 3 ripiani con tirante centrale 2 doors H 216 3 shelves with central tie beam</p>								
 <p>portascope 1 anta H 216 broom cabinet 1 door H 216</p>								
 <p>portascope con ripiani 1 anta H 216 broom cabinet with shelves 1 door H 216</p>								
 <p>anta H 216 integrata al gruppo cestelli estraibili chiusura soft door H 216 incorporated into the pull-out basket unit soft-closing system</p>								

COLONNE H 222 CON ZOCCOLO H 6

P 33 - 59,5







COLUMNS H 222 WITH PLINTH H 6

	COD.	BRIDGE MELAMI- NICO KT1	BRIDGE LACCATO KT2	BRIDGE WOOD KT0	HEAD MELAMI- NICO KT8	HEAD LACCATO KT9	HEAD WOOD KT7	
 <p>1 anta H 216 gruppo cestelli estraibili in filo orion grau chiusura soft 1 door H 216 orion grau wire pull-out basket unit soft-closing system</p>	L 45 P 59,5	EC161451/2	712	723	778	—	—	—
	L 60 P 59,5	EC161601/2	799	813	912	812	826	934
 <p>2 ante anta superiore H 72 anta inferiore H 144 2 doors upper door H 72 lower door H 144</p>	L 45 P 33	EC01345A1/2	408	420	450	458	474	486
	L 60 P 33	EC01360A1/2	479	495	543	534	558	589
 <p>2 ante anta superiore H 72 anta inferiore H 144 2 doors upper door H 72 lower door H 144</p>	L 30 P 59,5	EC06030A1/2	390	416	395	429	445	418
	L 45 P 59,5	EC06345A1/2	327	367	483	364	404	520
	L 60 P 59,5	EC06360A1/2	377	427	588	424	473	635
 <p>2 ante anta superiore H 132 anta inferiore H 84 2 doors upper door H 132 lower door H 84</p>	L 45 P 33	EC01045A1/2	408	425	446	456	478	482
	L 60 P 33	EC01060A1/2	479	492	543	533	554	589
 <p>2 ante anta superiore H 132 anta inferiore H 84 2 doors upper door H 132 lower door H 84</p>	L 45 P 59,5	EC06045A1/2	423	442	478	472	494	515
	L 60 P 59,5	EC06060A1/2	504	524	602	559	580	648
 <p>portascope 2 ante anta superiore H 72 anta inferiore H 144 broom cabinet 2 doors upper door H 72 lower door H 144</p>	L 30 P 59,5	EC10030A1/2	387	402	388	425	451	412
	L 45 P 59,5	EC10045A1/2	408	428	465	458	475	501

COLONNE H 222 CON ZOCCOLO H 6

P 59,5

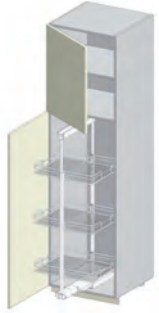



COLUMNS H 222 WITH PLINTH H 6

	COD.	BRIDGE MELAMI- NICO KT1	BRIDGE LACCATO KT2	BRIDGE WOOD KT0	HEAD MELAMI- NICO KT8	HEAD LACCATO KT9	HEAD WOOD KT7		
 <p>portascopie con ripiani 2 ante anta superiore H 72 anta inferiore H 144 broom cabinet with shelves 2 doors upper door H 72 lower door H 144</p>	L 60	EC10060A1/2	504	530	603	559	582	650	
	 <p>1 anta H 132 1 cassetto H 12 1 cassetto H 24 1 cestone H 48 1 door H 132 1 drawer H 12 1 drawer H 24 1 deep drawer H 48</p>	L 45	EC065461/2	484	520	637	555	591	709
L 60		EC065611/2	522	570	722	610	659	812	
 <p>1 anta H 132 1 cestone H 36 1 cestone H 48 1 door H 132 1 deep drawer H 36 1 deep drawer H 48</p>		L 45	EC066451/2	420	456	572	473	508	624
	L 60	EC066601/2	460	511	658	525	577	724	
	 <p>1 anta superiore H 72 1 anta H 144 integrata al gruppo cestelli estraibili in filo orion grau chiusura soft 1 upper door H 72 1 door H 144 incorporated into the orion grau wire the pull-out basket units soft-closing system</p>	L 30	EC16030A1/2	624	650	726	647	673	749
 <p>1 anta superiore H 72 1 anta inferiore H 144 gruppo cestelli estraibili in filo orion grau chiusura soft 1 upper door H 72 1 lower door H 144 orion grau wire pull-out basket unit soft-closing system</p>		L 45	EC16045A1/2	636	675	788	672	711	823
	L 60	EC16060A1/2	727	776	926	771	820	970	
	 <p>jolly colonna L da 15 a 30 jolly column size from 15 to 30</p>								
		EC002000	298	298	298	298	298	298	
		EC002030	441	—	—	441	—	—	
		EC005022	—	—	1.312	—	—	1.312	

COLONNE H 222 CON ZOCCOLO H 6

P 59,5





COLUMNS H 222 WITH PLINTH H 6

		COD.	BRIDGE MELAMI- NICO KT1	BRIDGE LACCATO KT2	BRIDGE WOOD KT0	HEAD MELAMI- NICO KT8	HEAD LACCATO KT9	HEAD WOOD KT7	
 <p>angolo 5 ripiani con tirante 1 anta H 216 pannello come anta corner unit 5 shelves with tie beam 1 upper door H 216 panel as door</p>	L 110 P 60	EC306111/2	768	819	936	—	—	—	
	L 125 P 60	EC306261/2	793	847	1.007	814	869	1.038	
 <p>angolo 8 cestelli estraibili indipendenti all'anta 1 anta H 216 pannello come anta corner unit 8 pull-out basket units 1 door H 216 panel as door</p>	L 110 P 60	EC307111/2	1.648	1.699	1.846	—	—	—	
	L 125 P 60	EC307261/2	1.804	1.858	2.053	1.825	1.880	2.084	
 <p>angolo 5 ripiani con tirante 1 anta superiore H 72 1 anta inferiore H 144 pannello come anta corner unit 5 shelves with tie beam 1 upper door H 72 1 lower door H 144 panel as door</p>	L 110 P 60	EC306101/2	777	825	948	831	883	992	
	L 125 P 60	EC306251/2	797	850	1.022	853	915	1.074	
 <p>angolo 8 cestelli estraibili indipendenti all'anta 1 anta superiore H 72 1 anta inferiore H 144 pannello come anta corner unit 8 pull-out basket units 1 upper door H 72 1 lower door H 144 panel as door</p>	L 110 P 60	EC307101/2	1.657	1.705	1.858	1.711	1.763	1.902	
	L 125 P 60	EC307251/2	1.808	1.861	2.068	1.864	1.926	2.120	

COLONNE PER FORNO H 114 - 150 CON ZOCCOLO H 6

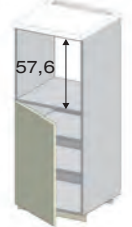
P 59,5

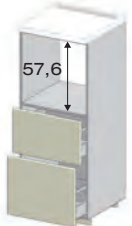

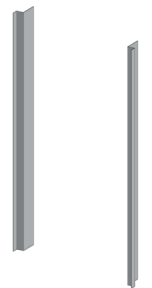
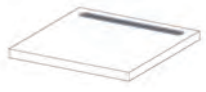

OVEN COLUMNS H 114 - 150 WITH PLINTH H 6

LE COLONNE NON SONO COMPRENSIVE DI TOP THE COLUMNS DO NOT INCLUDE THE TOPS		COD.	BRIDGE MELAMI- NICO KT1	BRIDGE LACCATO KT2	BRIDGE WOOD KT0	HEAD MELAMI- NICO KT8	HEAD LACCATO KT9	HEAD WOOD KT7		
 <p>colonna H 114 per forno 1 cestone chiuso H 48 oven column H 114 1 full deep drawer H 48</p>	L 60	EC501600	296	305	298	321	330	320		
	 <p>colonna H 150 per forno 1 anta H 84 oven column H 150 1 door H 84</p>	L 60	EC520601/2	336	345	350	362	375	372	
 <p>colonna H 150 per forno 1 cassetto H 12 1 cassetto H 24 1 cestone H 48 oven column H 150 1 drawer H 12 1 drawer H 24 1 deep drawer H 48</p>		L 60	EC521620	444	463	526	512	531	593	
	 <p>colonna H 150 per forno 1 cestone H 36 1 cestone H 48 oven column H 150 1 deep drawer H 36 1 deep drawer H 48</p>	L 60	EC521630	386	408	465	430	451	509	
 <p>profilo in acciaio a "L" per rifinire il ripiano del forno e microonde L-shaped steel finishing profile for shelf of oven and microwave</p>		L 60	08660100	9	9	9	9	9	9	
	 <p>kit protezione fianchi per forno protection kit sides for oven</p>	coppia couple	08630095	16	16	16	16	16	16	
 <p>top H 1,8 come anta P 59,6 per colonne worktop H 1,8 same as door D 59,6 for columns</p>										
			melaminico al ml melamine per lm	TLE186	77	—	—	77	—	—
			laccato al ml lacquered per lm	TLC196	—	96	—	—	96	—
			impiallacciato al ml veneered per lm	TLH186W	—	—	136	—	—	136
		mag.griglia di areazione cad. surcharge for ventilation grille each	T9FGA	30	30	30	30	30	30	

COLONNE PER FORNO H 222 CON ZOCCOLO H 6

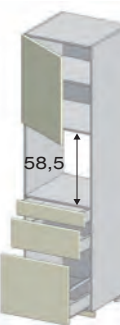
P 59,5

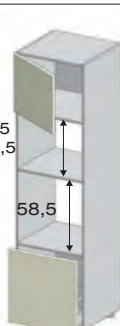



OVEN COLUMNS H 222 WITH PLINTH H 6

	COD.	BRIDGE MELAMI- NICO KT1	BRIDGE LACCATO KT2	BRIDGE WOOD KT0	HEAD MELAMI- NICO KT8	HEAD LACCATO KT9	HEAD WOOD KT7	
 <p>colonna per forno 1 anta superiore H 72 1 anta inferiore H 84 oven column 1 upper door H 72 1 lower door H 84</p>	L 60	EC53060A1/2	452	469	503	502	521	547
	L 75	EC53075A1/2	424	471	597	468	514	641
 <p>colonna per forno 1 anta H 72 1 cassetto H 12 1 cassetto H 24 1 cestone H 48 over column 1 door H 72 1 drawer H 12 1 drawer H 24 1 deep drawer H 48</p>	L 60	EC531621/2	645	667	690	742	768	779
 <p>colonna per forno 1 anta H 72 1 cestone H 36 1 cestone H 48 over column 1 door H 72 1 deep drawer H 36 1 deep drawer H 48</p>	L 60	EC531631/2	568	600	626	640	675	692
 <p>colonna per forno e micro 1 anta superiore a misura 1 vano micro da H 36,5 a 46,5 1 cestone H 60 oven and microwave column 1 upper door made to size 1 microwave compartment H 36,5 to 46,5 1 deep drawer H 60</p>	L 60	EC551601/2	568	583	571	618	633	589
 <p>colonna per forno e lavastoviglie Electrolux KESC 5300L - AEG FSE63307P 1 anta superiore H 48 1 anta lavastoviglie H 72 1 cestone H 36 column for oven and Electrolux KESC 5300L - AEG FSE63307P dishwasher 1 upper door H 48 1 dishwasher door H 72 1 deep drawer H 36</p>	L 60	EC573601/2	493	515	555	566	590	620

COLONNE PER FORNO H 222 CON ZOCCOLO H 6

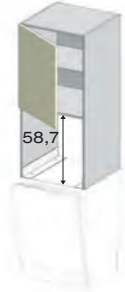
P 59,5



OVEN COLUMNS H 222 WITH PLINTH H 6

	COD.	BRIDGE MELAMI- NICO KT1	BRIDGE LACCATO KT2	BRIDGE WOOD KT0	HEAD MELAMI- NICO KT8	HEAD LACCATO KT9	HEAD WOOD KT7	
 <p>colonna forno sospesa H 132 per lavastoviglie 1 anta H 72 hanging oven column H 132 for dishwasher 1 door H 72</p>	L 60	E6576601/2	263	291	324	291	310	346
 <p>fianco per elettrodomestici a fine composizione side panel for appliances placed at the end of the composition</p>								
 <p>profilo in acciaio a "L" per rifinire il ripiano del forno e microonde L-shaped steel finishing profile for oven shelf and microwave</p>								
	L 60	08660100	9	9	9	9	9	9
 <p>kit protezione fianchi per forno protection kit sides for oven</p>								
	coppia couple	08630095	16	16	16	16	16	16

COLONNE PER FRIGO H 150 - 222 CON ZOCCOLO H 6

P 59,5

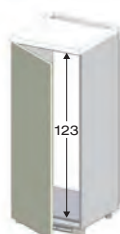
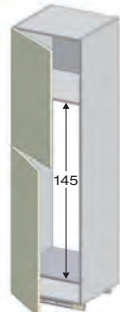
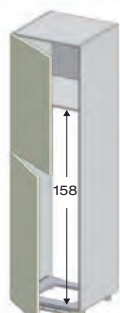

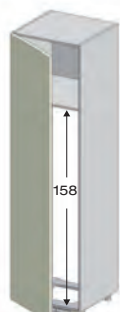
FRIDGE COLUMNS H 150 - 222 WITH PLINTH H 6

	COD.	BRIDGE MELAMI- NICO KT1	BRIDGE LACCATO KT2	BRIDGE WOOD KT0	HEAD MELAMI- NICO KT8	HEAD LACCATO KT9	HEAD WOOD KT7		
 <p>colonna H 150 per frigo 215 monoporta 1 anta H 144 column H 150 for 215 single-door fridge 1 door H 144</p>	L 60	EC452151/2	351	375	423	375	400	445	
	 <p>colonna H 222 per frigo-freezer 230 1 anta superiore H 96 1 anta inferiore H 120 column H 222 for 230 fridge-freezer 1 upper door H 96 1 lower door H 120</p>	L 60	EC46231A1/2	445	472	543	498	525	587
 <p>colonna H 222 per frigo-freezer 280 1 anta superiore H 96 1 anta inferiore H 120 column H 222 for 280 fridge-freezer 1 upper door H 96 1 lower door H 120</p>		L 60	EC46286A1/2	445	472	543	498	525	587
	 <p>colonna H 222 per frigo-congelatore 315 1 anta superiore H 132 1 anta inferiore H 84 column H 222 for 315 fridge-freezer 1 upper door H 132 1 lower door H 84</p>	L 60	EC46315A1/2	445	472	543	498	525	587
 <p>colonna H 222 per frigo-congelatore 315 1 anta superiore H 24 1 anta centrale H 108 1 anta inferiore H 84 column H 222 for 315 fridge-freezer 1 upper door H 24 1 central door H 108 1 lower door H 84</p>		L 60	EC463161/2	483	510	566	562	594	699
	 <p>colonna H 222 per frigo-freezer 280 1 anta H 216 column H 222 for 280 fridge-freezer 1 upper door H 216</p>	L 60	EC462871/2	483	472	543	562	525	587

COLONNE PER FRIGO H 222 CON ZOCCOLO H 6

P 59,5

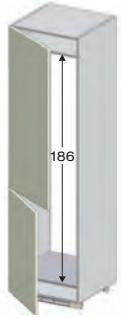
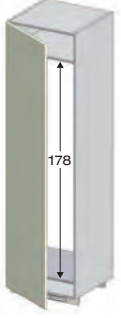

FRIDGE COLUMNS H 222 WITH PLINTH H 6

	COD.	BRIDGE MELAMI- NICO KT1	BRIDGE LACCATO KT2	BRIDGE WOOD KT0	HEAD MELAMI- NICO KT8	HEAD LACCATO KT9	HEAD WOOD KT7	
 <p>colonna H 222 per frigo-congelatore 330 1 anta superiore H 132 1 anta inferiore H 84 column H 222 for 330 fridge-freezer 1 upper door H 132 1 lower door H 84</p>								
	L 60 EC46330A1/2	445	472	543	498	525	587	
 <p>colonna H 222 per frigo-freezer 300 monoporta 1 anta H 216 column H 222 for 300 single-door fridge-freezer 1 door H 216</p>								
	L 60 EC463001/2	445	472	543	498	525	587	
 <p>colonna H 222 per frigo-congelatore 350 1 anta superiore H 132 1 anta inferiore H 84 column H 222 for 350 fridge-freezer 1 upper door H 132 1 lower door H 84</p>								
	L 60 EC46350A1/2	445	472	543	498	525	587	
 <p>colonna H 222 per frigo-congelatore 400 1 anta superiore H 132 1 anta inferiore H 84 column H 222 for 400 fridge-freezer 1 upper door H 132 1 lower door H 84</p>								
	L 75 EC46400A1/2	633	664	675	699	730	720	





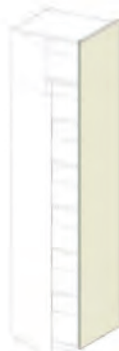

SOPRACOLONNE

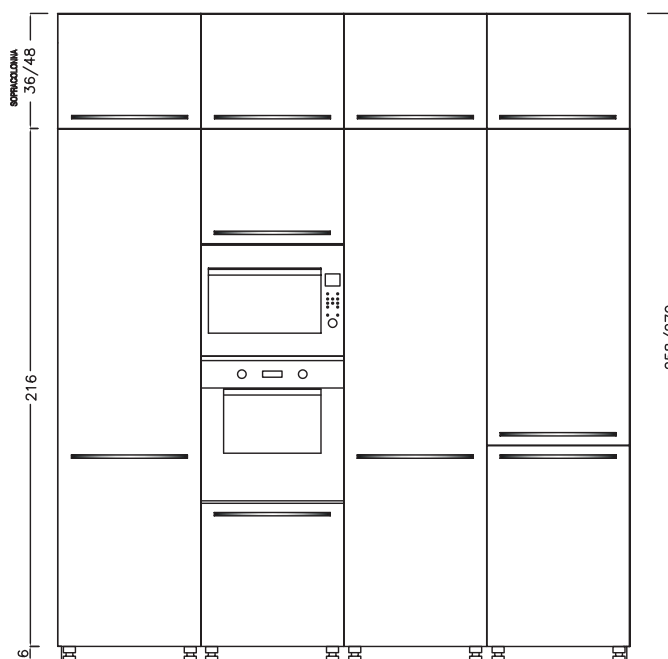

TOP COLUMNS





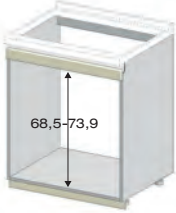

P 59,5

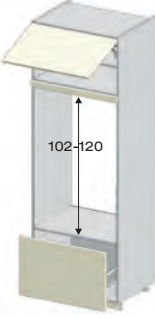
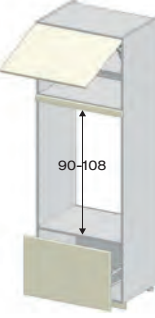
	COD.	BRIDGE MELAMI- NICO KT1	BRIDGE LACCATO KT2	BRIDGE WOOD KT0	HEAD MELAMI- NICO KT8	HEAD LACCATO KT9	HEAD WOOD KT7		
 <p>sopracolonna 1 anta top column 1 door</p>	H 36 L 30	EC601301/2	141	142	150	145	158	161	
	L 45	EC601451/2	131	139	155	146	154	173	
	L 60	EC601601/2	144	155	174	163	174	196	
	ribalta TIP-ON L 75 flap door TIP-ON	EC61076T	230	246	272	230	246	272	
	H 48 L 30	EC602301/2	176	180	175	190	199	187	
	L 45	EC602451/2	169	180	187	185	195	204	
	L 60	EC602601/2	186	200	211	205	218	234	
	ribalta TIP-ON L 75 flap door TIP-ON	EC61276T	275	295	319	275	295	319	
	 <p>sopracolonna 1 anta vetro top column 1 glass door</p>	telaio alluminio H 36 L 45	EC605461/2	208	208	208	208	208	208
		L 60	EC605611/2	231	231	231	231	231	231
		H 48 L 45	EC606461/2	236	236	236	236	236	236
		L 60	EC606611/2	291	291	291	291	291	291
		telaio melaminico H 36 L 45	EC605451/2	233	—	—	233	—	—
		L 60	EC605601/2	264	—	—	264	—	—
H 48 L 45		EC606451/2	263	—	—	263	—	—	
L 60		EC606601/2	326	—	—	326	—	—	
 <p>fianco per colonna side panel for column</p>		fianco side panel							
		H 251,7x59,6x1,8	T94390	120	—	317	120	—	317
	H 263,7x59,6x1,8	T94392	180	—	330	180	—	330	
	H 251,7x59,7x1,9	T94391	—	176	—	—	176	—	
	H 263,7x59,7x1,9	T94393	—	235	—	—	235	—	



		COD.	NECK MELAMI- NICO KT5	NECK LACCATO KT6	NECK WOOD KT4			
 <p>base per forno H 88 1 fascia superiore staffe inferiori fianco H 75 P 61 senza gola oven base unit H 88 1 upper panel lower brackets side H 75 D 61 without finger rail</p>								
	L 76,2	USABF7577	202	192	196			
 <p>base per forno H 89,2 1 fascia superiore staffe inferiori fianco H 76,2 P 61 senza gola oven base unit H 89,2 1 upper panel lower brackets side H 76,2 D 61 without finger rail</p>								
	L 76,2	USABF7777	186	192	196			
 <p>colonna per doppio forno H 217 1 anta ribalta TIP-ON H 36 1 fascia superiore 1 ripiano smontato 1 cestone TIP-ON H 36 double oven column H 217 1 flap door TIP-ON H 36 1 upper band 1 disassembled shelf 1 deep drawer TIP-ON H 36</p>								
	L 76,2	USACF204C3	491	524	581			
 <p>colonna per doppio forno H 217 1 anta ribalta TIP-ON H 48 1 fascia superiore 1 ripiano smontato 1 cestone TIP-ON H 36 double oven column H 217 1 flap door TIP-ON H 48 1 upper band 1 disassembled shelf 1 deep drawer TIP-ON H 36</p>								
	L 76,2	USACF204C4	495	532	599			
 <p>colonna per doppio forno H 217 1 anta ribalta TIP-ON H 60 1 fascia superiore 1 ripiano smontato 1 cestone TIP-ON H 36 double oven column H 217 1 flap door TIP-ON H 60 1 upper band 1 disassembled shelf 1 deep drawer TIP-ON H 36</p>								
	L 76,2	USACF204C6	567	606	677			
 <p>colonna per doppio forno H 241 1 anta ribalta TIP-ON H 60 1 fascia superiore 1 ripiano smontato 1 cestone TIP-ON H 36 double oven column H 241 1 flap door TIP-ON H 60 1 upper band 1 disassembled shelf 1 deep drawer TIP-ON H 36</p>								
	L 76,2	USACF228C6	583	624	699			



		COD.	NECK MELAMI- NICO KT5	NECK LACCATO KT6	NECK WOOD KT4			
 <p>base per forno H 90 1 fascia superiore staffe inferiori fianco H 84 P 61 oven base unit H 90 1 upper panel lower brackets side H 84 D 61</p>								
	L 76,2	USABFG8477	221	229	237			
 <p>colonna per doppio forno H 222 1 anta ribalta TIP-ON H 36 1 fascia superiore 1 ripiano smontato 1 cestone TIP-ON H 48 double oven column H 222 1 flap door TIP-ON H 36 1 upper band 1 disassembled shelf 1 deep drawer TIP-ON H 48</p>								
	L 76,2	USACF216C3	518	555	621			
 <p>colonna per doppio forno H 222 1 anta ribalta TIP-ON H 48 1 fascia superiore 1 ripiano smontato 1 cestone TIP-ON H 48 double oven column H 222 1 flap door TIP-ON H 48 1 upper band 1 disassembled shelf 1 deep drawer TIP-ON H 48</p>								
	L 76,2	USACF216C4	558	597	672			
 <p>colonna per doppio forno H 222 1 anta ribalta TIP-ON H 60 1 fascia superiore 1 ripiano smontato 1 cestone TIP-ON H 48 double oven column H 222 1 flap door TIP-ON H 60 1 upper band 1 disassembled shelf 1 deep drawer TIP-ON H 48</p>								
	L 76,2	USACF216C6	594	637	717			



	COD.	BRIDGE MELAMI- NICO KT1	BRIDGE LACCATO KT2	BRIDGE WOOD KT0	HEAD MELAMI- NICO KT8	HEAD LACCATO KT9	HEAD WOOD KT7	
 <p>base per forno H 85 staffe inferiori fianco H 72 P 61 oven base unit H 85 lower brackets side H 72 D 61</p>								
	L 76,2	USABF7277	155	155	155	155	155	
 <p>base per forno H 89,2 1 fascia superiore staffe inferiori fianco H 76,2 P 61 oven base unit H 89,2 1 upper panel lower brackets side H 76,2 D 61</p>								
	L 76,2	USABF7777	186	192	196	186	192	196
 <p>colonna per doppio forno H 217 1 anta ribalta TIP-ON H 36 1 fascia superiore 1 ripiano smontato 1 cestone H 36 double oven column H 217 1 flap door TIP-ON H 36 1 upper band 1 disassembled shelf 1 deep drawer H 36</p>								
	L 76,2	USACF204C3	491	524	581	491	524	581
 <p>colonna per doppio forno H 217 1 anta ribalta TIP-ON H 48 1 fascia superiore 1 ripiano smontato 1 cestone H 36 double oven column H 217 1 flap door TIP-ON H 48 1 upper band 1 disassembled shelf 1 deep drawer H 36</p>								
	L 76,2	USACF204C4	495	532	599	495	532	599
 <p>colonna per doppio forno H 217 1 anta ribalta TIP-ON H 60 1 fascia superiore 1 ripiano smontato 1 cestone H 36 double oven column H 217 1 flap door TIP-ON H 60 1 upper band 1 disassembled shelf 1 deep drawer H 36</p>								
	L 76,2	USACF204C6	567	606	677	567	606	677
 <p>colonna per doppio forno H 243 1 anta ribalta TIP-ON H 60 1 fascia superiore 1 ripiano smontato 1 cestone H 36 double oven column H 241 1 flap door TIP-ON H 60 1 upper band 1 disassembled shelf 1 deep drawer H 36</p>								
	L 76,2	USACF228C6	583	624	699	583	624	699

BASI E COLONNE PER FORNO CON ZOCCOLO H 6 MERCATO U.S.A.

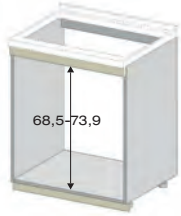
P 63,4

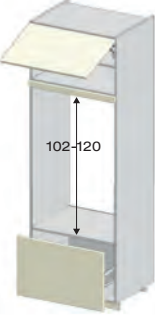
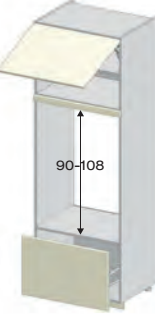
BASE AND COLUMNS UNITS CONFIGURED FOR OVEN WITH PLINTH H 6 FOR U.S. MARKET PLACE

	COD.	BRIDGE MELAMI- NICO KT1	BRIDGE LACCATO KT2	BRIDGE WOOD KT0	HEAD MELAMI- NICO KT8	HEAD LACCATO KT9	HEAD WOOD KT7		
 <p>base per forno H 90 1 fascia superiore staffe inferiori fianco H 84 P 61 oven base unit H 90 1 upper panel lower brackets side H 84 D 61</p> <p>68,5-73,9</p>	L 76,2	USABF8477	203	207	219	203	207	219	
 <p>colonna per doppio forno H 222 1 anta ribalta TIP-ON H 36 1 fascia superiore 1 ripiano smontato 1 cestone H 48 double oven column H 222 1 flap door TIP-ON H 36 1 upper band 1 disassembled shelf 1 deep drawer H 48</p> <p>114-132</p>	L 76,2	USACF216C3	518	555	621	518	555	621	
 <p>colonna per doppio forno H 222 1 anta ribalta TIP-ON H 48 1 fascia superiore 1 ripiano smontato 1 cestone H 48 double oven column H 222 1 flap door TIP-ON H 48 1 upper band 1 disassembled shelf 1 deep drawer H 48</p> <p>102-120</p>	L 76,2	USACF216C4	558	597	672	558	597	672	
 <p>colonna per doppio forno H 222 1 anta ribalta TIP-ON H 60 1 fascia superiore 1 ripiano smontato 1 cestone H 48 double oven column H 222 1 flap door TIP-ON H 60 1 upper band 1 disassembled shelf 1 deep drawer H 48</p> <p>90-108</p>	L 76,2	USACF216C6	594	637	717	594	637	717	

	COD.	NECK	NECK	NECK	BRIDGE/HEAD			
		MELAMI- NICO KT5	LACCATO KT6	WOOD KT4	MELAMI- NICO KT1-KT8	LACCATO KT2-KT9	WOOD KT0-KT7	
<p>1 anta ribalta H 36 1 flap door H 36</p> 								
	L 76,2	USASC3677C	250	263	284	250	263	284
	L 91,4	USASC3692C	253	267	294	253	267	294
<p>1 anta ribalta H 48 1 ripiano 1 flap door H 48 1 shelf</p> 								
	L 76,2	USASC4877C	306	321	350	306	321	350
	L 91,4	USASC4892C	315	333	370	315	333	370
<p>1 anta ribalta H 60 1 ripiano 1 flap door H 60 1 shelf</p> 								
	L 76,2	USASC6077C	374	393	430	374	393	430

FIANCHI DI FINITURA

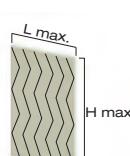
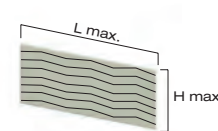
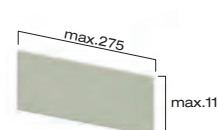

FINISHING SIDE PANELS

	COD.	NECK	NECK	NECK	BRIDGE/HEAD		
		MELAMI- NICO KT5	LACCATO KT6	WOOD KT4	MELAMI- NICO KT1-KT8	LACCATO KT2-KT9	WOOD KT0-KT7
<p>maggiorazione per fianchi di struttura come anta (cadauno) venatura verticale e tinta unita surcharge for carcass sides same finish as door (each) vertical grain and full colour</p> 							
	PENSILE / WALL UNIT						
	36x31	+24	+28	+34	+24	+28	+34
	48x31	+26	+30	+40	+26	+30	+40
	60x31	+29	+32	+46	+29	+32	+46
	72x31	+34	+37	+53	+34	+37	+53
	96x31	+40	+44	+66	+40	+44	+66
	108x31	+42	+46	+80	+42	+46	+80
	120x31	+42	+46	+80	+42	+46	+80
	BASE NECK / NECK BASE UNIT						
	37,5x57,5	+30	+35	+52	—	—	—
	51x57,5	+33	+39	+65	—	—	—
	63x57,5	+36	+42	+76	—	—	—
	75x57,5	+39	+45	+83	—	—	—
	BASE BRIDGE-HEAD / BRIDGE-HEAD BASE UNIT						
	36x57,5	—	—	—	+30	+35	+52
	48x57,5	—	—	—	+33	+39	+65
	60x57,5	—	—	—	+36	+42	+76
	72x57,5	—	—	—	+39	+45	+83
	COLONNA / COLUMN						
	132x31	+45	+50	+84	+45	+50	+84
	204x31	+55	+65	+108	+55	+65	+108
	228x31	+63	+73	+120	+63	+73	+120
	96x57,5	+44	+52	+102	+44	+52	+102
	132x57,5	+52	+61	+133	+52	+61	+133
	204x57,5	+64	+82	+198	+64	+82	+198
	228x57,5	+67	+89	+220	+67	+89	+220
	BASE ZOCCOLO H 6 / BASE UNIT - PLINTH H 6						
84x57,5	+51	+52	+98	+51	+52	+98	
COLONNA ZOCCOLO H 6 / COLUMN - PLINTH H 6							
216x31	+106	+65	+116	+106	+65	+116	
108x57,5	+61	+61	+119	+61	+61	+119	
144x57,5	+86	+82	+153	+86	+82	+153	
216x57,5	+116	+89	+210	+116	+89	+210	
<p>pannello di finitura SP. 1,8 come anta (finiture legno venatura verticale, rifinito 2 lati) N.B.: quantità minima fatturabile 0,5 mq finishing panel TH. 1,8 same colour as door (wood finishes with vertical grain, finish on 2 sides) Note: 0,5 square meter, min.quantity that can be invoiced</p> 							
	al mq per m ²						
	L max.130 H max.275 melaminico W max.130 H max.275 melamine L max.110 H max.275 impiallacciato W max.110 H max.275 veneered	094506V	121	—	—	121	—
	094524VW	—	—	214	—	214	
<p>pannello di finitura SP. 1,8 come anta (finiture legno venatura orizzontale, rifinito 2 lati) N.B.: quantità minima fatturabile 0,5 mq finishing panel TH. 1,8 same colour as door (wood finish with horizontal grain, finish on 2 sides) Note: 0,5 square meter, min.quantity that can be invoiced</p> 							
	al mq per m ²						
	L max.275 H max.130 melaminico W max.275 H max.130 melamine L max.275 H max.110 impiallacciato W max.275 H max.110 veneered	094506	121	—	—	121	—
	094524W	—	—	214	—	214	
<p>pannello di finitura SP. 1,9 finitura come anta laccata N.B.: quantità minima fatturabile 0,5 mq finishing panel TH. 1,9 same finish as lacquered door Note: 0,5 square meter, min.quantity that can be invoiced</p> 							
	al mq per m ²						
L max.275 H max.110 laccato W max.275 H max.110 lacquered	094530	—	161	—	—	161	

ANTE DI FINITURA LATERALI

LATERAL FINISHING DOORS

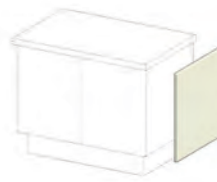
* Per il codice sostituire le XXX con il codice della versione corrispondente
 * Replace XXX with the concerning code version

	*COD.	NECK MELAMI- NICO KT5	NECK LACCATO KT6	NECK WOOD KT4			
ante di finitura laterali SP. 1,8 lateral finishing doors th. 1,8 							
PENSILE							
WALL UNIT							
H 36 (35,7x33,1)	1XXX4045	29	35	39			
H 48 (47,7x33,1)	1XXX4046	30	38	47			
H 60 (59,7x33,1)	1XXX4047	32	42	54			
H 72 (71,7x33,1)	1XXX405	35	46	62			
H 96 (95,7x33,1)	1XXX406	41	53	77			
H 108 (107,7x33,1)	1XXX4065	43	60	87			
H 120 (119,7x33,1)	1XXX407	43	60	95			
H 36 (35,7x48,1)	1XXX40A1	34	44	49			
H 48 (47,7x48,1)	1XXX40A2	37	51	60			
H 60 (59,7x48,1)	1XXX40A3	40	57	71			
H 72 (71,7x48,1)	1XXX40A4	43	63	81			
ante di finitura laterali SP. 1,8 - ZOCCOLO H 13 lateral finishing doors th. 1,8 - PLINTH H 13 N.B.: senza gola Note: without finger rail 							
BASE ZOCCOLO H 13							
BASE UNIT - PLINTH H 13							
H 50,5 (37,2x59,6)	1XXX3952	34	44	59			
H 64 (50,7x59,6)	1XXX3963	37	51	73			
H 68 (54,7x59,6)	1XXX3973	38	52	78			
H 76 (62,7x59,6)	1XXX3983	40	57	86			
H 88 (74,7x59,6)	1XXX4003	43	63	100			
ISOLA ZOCCOLO H 13							
ISLAND - PLINTH H 13							
H 76 (62,7x61,6)	1XXX4023	41	58	89			
H 88 (74,7x61,6)	1XXX4033	43	64	104			
H 88 (74,7x74,6)	1XXX4035	48	87	125			
H 88 (74,7x92,6)	1XXX4034	57	87	150			
COLONNA ZOCCOLO H 13							
COLUMN - PLINTH H 13							
H 109 (95,7x59,6)	1XXX409	48	73	123			
H 145 (131,7x59,6)	1XXX410	57	91	163			
H 217 (203,7x59,6)	1XXX411	77	129	263			
H 241 (227,7x59,6)	1XXX412	83	142	274			
anta di finitura laterali SP. 1,8 - ZOCCOLO H 6 lateral finishing doors th. 1,8 - PLINTH H 6 N.B.: senza gola Note: without finger rail 							
BASE ZOCCOLO H 6							
BASE UNIT - PLINTH H 6							
H 75 (68,7x59,6)	1XXX4501	41	59	105			
H 90 (83,7x59,6)	1XXX4205	45	66	111			
H 90 (83,7x74,6)	1XXX4208	52	69	139			
ISOLA ZOCCOLO H 6							
ISLAND - PLINTH H 6							
H 75 (68,7x61,6)	1XXX4502	42	60	107			
H 75 (68,7x92,6)	1XXX4503	49	77	147			
H 90 (83,7x61,6)	1XXX4206	46	67	115			
H 90 (83,7x92,6)	1XXX4207	60	80	167			
COLONNA ZOCCOLO H 6							
COLUMN - PLINTH H 6							
H 114 (107,7x59,6)	1XXX4152	52	76	138			
H 150 (143,7x59,6)	1XXX4154	61	95	178			
H 222 (215,7x59,6)	1XXX4156	80	135	261			

ANTE DI FINITURA POSTERIORI

REAR FINISHING DOORS

* Per il codice sostituire le XXX con il codice della versione corrispondente
 * Replace XXX with the concerning code version

ante di finitura posteriori SP. 1,8
senza gola
 rear finishing doors th.1,8
 without finger rail



BASE ZOCCOLO H 13
 BASE UNIT - PLINTH H 13

	*COD.	NECK MELAMI- NICO KT5	NECK LACCATO KT6	NECK WOOD KT4			
L 45 (62,7x 44,7)	1XXX4243	47	60	80			
L 60 (62,7x 59,7)	1XXX4263	51	69	97			
L 90 (62,7x 89,7)	1XXX4283	59	84	133			
L 120 (62,7x119,7)	1XXX4293	65	90	—			
L 30 (74,7x 29,7)	1XXX4303	45	56	70			
L 40 (74,7x 39,7)	1XXX4323	48	62	84			
L 45 (74,7x 44,7)	1XXX4343	49	65	90			
L 60 (74,7x 59,7)	1XXX4363	54	74	111			
L 65 (74,7x 64,7)	1XXX4383	55	77	119			
L 90 (74,7x 89,7)	1XXX4403	67	97	156			
L 120 (74,7x119,7)	1XXX4423	73	101	—			

BASE ZOCCOLO H 6
 BASE UNIT - PLINTH H 6

L 30 (83,7x 29,7)	1XXX4211	48	61	75			
L 40 (83,7x 39,7)	1XXX4212	51	67	88			
L 45 (83,7x 44,7)	1XXX4213	53	71	98			
L 60 (83,7x 59,7)	1XXX4214	59	81	121			
L 65 (83,7x 64,7)	1XXX4215	61	85	130			
L 90 (83,7x 89,7)	1XXX4216	70	104	171			
L 120 (83,7x119,7)	1XXX4217	81	126	—			

ante di finitura posteriori SP. 1,8
per basi uso penisola-isola
con gola
 rear finishing doors th.1,8
 for base units used as peninsula-island
 with finger rail

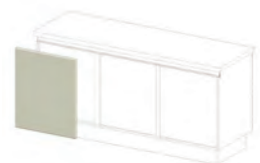

BASE ZOCCOLO H 13
 BASE UNIT - PLINTH H 13

L 45 (59,7x 44,7)	1XXX424	60	72	89			
L 60 (59,7x 59,7)	1XXX426	68	84	110			
L 90 (59,7x 89,7)	1XXX428	85	109	153			
L 120 (59,7x119,7)	1XXX429	89	118	—			
L 30 (71,7x 29,7)	1XXX430	53	63	76			
L 40 (71,7x 39,7)	1XXX432	59	72	92			
L 45 (71,7x 44,7)	1XXX434	62	77	100			
L 60 (71,7x 59,7)	1XXX436	70	90	124			
L 65 (71,7x 64,7)	1XXX438	73	94	132			
L 90 (71,7x 89,7)	1XXX440	92	120	174			
L 120 (71,7x119,7)	1XXX442	100	129	—			



BASE ZOCCOLO H 6
 BASE UNIT - PLINTH H 6

L 30 (80,7x 29,7)	1XXX4231	62	74	89			
L 40 (80,7x 39,7)	1XXX4232	74	90	109			
L 45 (80,7x 44,7)	1XXX4233	81	97	119			
L 60 (80,7x 59,7)	1XXX4234	98	119	149			
L 65 (80,7x 64,7)	1XXX4235	105	127	160			
L 90 (80,7x 89,7)	1XXX4236	121	154	202			
L 120 (80,7x119,7)	1XXX4237	152	195	—			

ANTE DI FINITURA LATERALI

LATERAL FINISHING DOORS

* Per il codice sostituire le XXX con il codice della versione corrispondente
* Replace XXX with the concerning code version

*COD.	BRIDGE MELAMI- NICO KT1	BRIDGE LACCATO KT2	BRIDGE WOOD KT0	HEAD MELAMI- NICO KT8	HEAD LACCATO KT9	HEAD WOOD KT7	
<p>ante di finitura laterali SP. 1,8 N.B.: senza profilo maniglia lateral finishing doors th. 1,8 Note: without handle profile</p> 							
PENSILE							
WALL UNIT							
H 36 (35,7x33,1)	1XXX4045	29	35	39	29	35	39
H 48 (47,7x33,1)	1XXX4046	30	38	47	30	38	47
H 60 (59,7x33,1)	1XXX4047	32	42	54	32	42	54
H 72 (71,7x33,1)	1XXX405	35	46	62	35	46	62
H 96 (95,7x33,1)	1XXX406	41	53	77	41	53	77
H 108 (107,7x33,1)	1XXX4065	43	60	87	43	60	87
H 120 (119,7x33,1)	1XXX407	43	60	95	43	60	95
H 36 (35,7x48,1)							
H 48 (47,7x48,1)							
H 60 (59,7x48,1)							
H 72 (71,7x48,1)							
H 36 (35,7x59,6)							
H 48 (47,7x59,6)							
H 60 (59,7x59,6)							
H 72 (71,7x59,6)							
<p>ante di finitura laterali SP. 1,8 - ZOCCOLO H 13 N.B.: senza profilo maniglia lateral finishing doors th. 1,8 - PLINTH H 13 Note: without handle profile</p> 							
BASE ZOCCOLO H 13							
BASE UNIT - PLINTH H 13							
H 49 (35,7x59,6)	1XXX395	34	44	59	34	44	59
H 61 (47,7x59,6)	1XXX396	37	51	73	37	51	73
H 73 (59,7x59,6)	1XXX398	40	57	86	40	57	86
H 85 (71,7x59,6)	1XXX400	43	63	100	43	63	100
ISOLA ZOCCOLO H 13							
ISLAND - PLINTH H 13							
H 73 (59,7x61,6)	1XXX402	41	58	89	41	58	89
H 85 (71,7x61,6)	1XXX403	43	64	104	43	64	104
H 85 (71,7x74,6)	1XXX4032	48	87	125	48	87	125
H 85 (71,7x92,6)	1XXX4031	57	87	150	57	87	150
COLONNA ZOCCOLO H 13							
COLUMN - PLINTH H 13							
H 109 (95,7x59,6)	1XXX409	48	73	123	48	73	123
H 145 (131,7x59,6)	1XXX410	57	91	163	57	91	163
H 217 (203,7x59,6)	1XXX411	77	129	263	77	129	263
H 241 (227,7x59,6)	1XXX412	83	142	274	83	142	274
<p>anta di finitura laterali SP. 1,8 - ZOCCOLO H 6 N.B.: senza profilo maniglia lateral finishing doors th. 1,8 - PLINTH H 6 Note: without handle profile</p> 							
BASE ZOCCOLO H 6							
BASE UNIT - PLINTH H 6							
H 78 (71,7x59,6)	1XXX400	43	63	107	43	63	107
H 90 (83,7x59,6)	1XXX4205	45	66	111	45	66	111
H 90 (83,7x74,6)	1XXX4208	52	69	139	52	69	139
ISOLA ZOCCOLO H 6							
ISLAND - PLINTH H 6							
H 78 (71,7x61,6)	1XXX403	43	64	111	43	64	111
H 78 (71,7x92,6)	1XXX4031	57	87	159	57	87	159
H 90 (83,7x61,6)	1XXX4206	46	67	115	46	67	115
H 90 (83,7x92,6)	1XXX4207	60	80	167	60	80	167
COLONNA ZOCCOLO H 6							
COLUMN - PLINTH H 6							
H 114 (107,7x59,6)	1XXX4152	52	76	138	52	76	138
H 150 (143,7x59,6)	1XXX4154	61	95	178	61	95	178
H 222 (215,7x59,6)	1XXX4156	80	135	261	80	135	261

ANTE DI FINITURA POSTERIORI

REAR FINISHING DOORS

* Per il codice sostituire le XXX con il codice della versione corrispondente
 * Replace XXX with the concerning code version

ante di finitura posteriori SP.1,8
 per basi uso penisola-isola
ZOCCOLO H 13

N.B.: senza profilo maniglia

rear finishing doors th.1,8
 for base units used as peninsula-island
 PLINTH H 13

Note: without handle profile



BASE ZOCCOLO H 13
 BASE UNIT - PLINTH H 13

	*COD.	BRIDGE MELAMI- NICO KT1	BRIDGE LACCATO KT2	BRIDGE WOOD KT0	HEAD MELAMI- NICO KT8	HEAD LACCATO KT9	HEAD WOOD KT7
L 45 (59,7x 44,7)	1XXX424	46	59	78	46	59	78
L 60 (59,7x 59,7)	1XXX426	51	67	94	51	67	94
L 90 (59,7x 89,7)	1XXX428	59	83	130	59	83	130
L 120 (59,7x119,7)	1XXX429	61	90	—	61	90	—
L 30 (71,7x 29,7)	1XXX430	44	55	68	44	55	68
L 40 (71,7x 39,7)	1XXX432	47	61	81	47	61	81
L 45 (71,7x 44,7)	1XXX434	48	64	88	48	64	88
L 60 (71,7x 59,7)	1XXX436	53	73	107	53	73	107
L 65 (71,7x 64,7)	1XXX438	54	75	114	54	75	114
L 90 (71,7x 89,7)	1XXX440	62	90	148	62	90	148
L 120 (71,7x119,7)	1XXX442	72	101	—	72	101	—

ante di finitura posteriori SP.1,8
 per basi uso penisola-isola
ZOCCOLO H 6

N.B.: senza profilo maniglia

rear finishing doors th.1,8
 for base units used as peninsula-island
 PLINTH H 6

Note: without handle profile







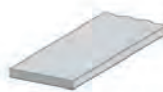

BASE ZOCCOLO H 6
 BASE UNIT - PLINTH H 6

	*COD.	BRIDGE MELAMI- NICO KT1	BRIDGE LACCATO KT2	BRIDGE WOOD KT0	HEAD MELAMI- NICO KT8	HEAD LACCATO KT9	HEAD WOOD KT7
L 30 (83,7x 29,7)	1XXX4211	48	61	75	48	61	75
L 40 (83,7x 39,7)	1XXX4212	51	67	88	51	67	88
L 45 (83,7x 44,7)	1XXX4213	53	71	98	53	71	98
L 60 (83,7x 59,7)	1XXX4214	59	81	121	59	81	121
L 65 (83,7x 64,7)	1XXX4215	61	85	130	61	85	130
L 90 (83,7x 89,7)	1XXX4216	70	104	171	70	104	171
L 120 (83,7x119,7)	1XXX4217	81	126	—	81	126	—

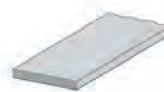
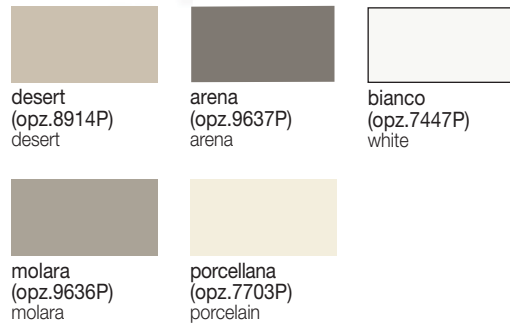
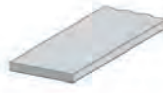
MENSOLE

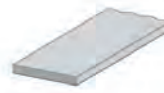
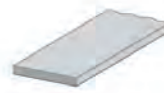
SHELVES



	COD.	€		COD.	€
<p>mensola sp. 3,8 in nobilitato colori strutture L max cm 400 laminate shelf Th. 3,8 carcasses colours Max. lenght 400 cm</p>   <p>prezzi al ml prices per lm</p> <p>P 31 091523 65 P 61 091560 84</p>			<p>mensola sp. 3,8 in melaminico come anta tinta unita con bordo ABS multistrato L max cm 275 melamine shelf Th. 3,8 melamine with solid colour door with ABS ply edge Max. lenght 275 cm</p>   <p>prezzi al ml prices per lm</p> <p>P 31 091523 116 P 33,1 091528 122 P 61 091560 152</p>		
<p>mensola sp. 3,8 in melaminico come anta: effetto legno, effetto cemento e tinta unita L max cm 275 melamine shelf Th. 3,8 same finish as door: wood-effect, cement-effect and solid colour Max. lenght 275 cm</p>   <p>prezzi al ml prices per lm</p> <p>P 31 091523 116 P 33,1 091528 122 P 61 091560 152</p>			<p>mensola sp. 3,8 laccata come anta. L max cm 300 N.B.: per i colori vedi pag.22-23 shelf Th. 3,8 lacquered same as door. Max. lenght 300 cm Note: for colours see page 22-23</p>  <p>LACCATA OPACA prezzi al ml Matt lacquered prices per lm</p> <p>P 31 091733 171 P 33,2 0917340 184 P 61 091736 311</p> <p>LACCATA LUCIDA prezzi al ml Glossy lacquered prices per lm</p> <p>P 31 091733 171 P 33,2 0917340 184 P 61 091736 311</p>		
			<p>mensola sp. 3,8 impiallacciata come anta. L max cm 300 shelf Th. 3,8 veneered same as door. Max. lenght 300 cm</p>   <p>prezzi al ml prices per lm</p> <p>P 31 091723W 248 P 33,1 0917234W 248 P 61 091729W 377</p>		

MENSOLE
 TERMINALIA GIORNO
 SHELVES - OPEN END UNITS

TERMINALI A GIORNO LACCATO OPACO PER ISOLA E PENISOLA

MATT LACQUERED ISLAND AND PENINSULA OPEN END UNITS

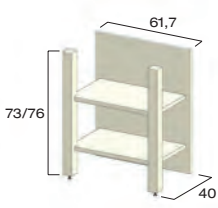
VEDI CATALOGO FINITURE LACCATE (GRUPPO LUBE)
SEE LACQUERED FINISHES CATALOGUE (GRUPPO LUBE)

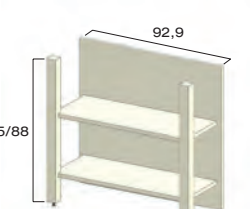
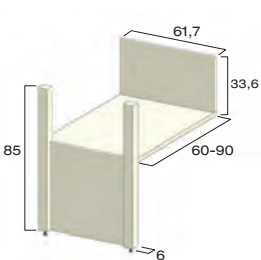
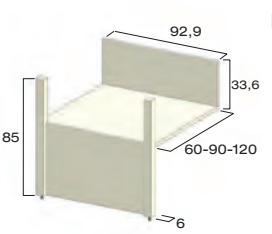
		COD.	€					
 <p>terminale a giorno laccato opaco per isola ribassata matt lacquered open end unit for lowered island</p>								
	NECK							
	L 61,7 H 76 P 40	ETB00520	438					
	BRIDGE-HEAD							
L 61,7 H 73 P 40	ETB00515	438						
 <p>terminale a giorno laccato opaco matt lacquered open end unit</p>								
	NECK							
	L 61,7 H 88 P 40	ETB00620	451					
	BRIDGE-HEAD							
L 61,7 H 85 P 40	ETB00615	451						
 <p>terminale a giorno laccato opaco matt lacquered open end unit</p>								
	NECK							
	L 92,9 H 88 P 40	ETB00640	487					
	BRIDGE-HEAD							
L 92,9 H 85 P 40	ETB00635	487						
 <p>terminale a giorno laccato opaco da inserire in appoggio con base H 49 matt lacquered open end unit to be inserted in support with base unit H 49</p>								
	BRIDGE-HEAD							
	L 61,7 H 85 P 66	ETB00715	343					
	L 61,7 H 85 P 96	ETB00717	390					
 <p>terminale a giorno laccato opaco da inserire in appoggio con base H 49 matt lacquered open end unit to be inserted in support with base unit H 49</p>								
	BRIDGE-HEAD							
	L 92,9 H 85 P 66	ETB00741	452					
	L 92,9 H 85 P 96	ETB00743	520					
L 92,9 H 85 P 126	ETB00745	602						

MOBILE DI FINITURA "SIDE"

"SIDE" FINISHING FURNITURE



COLORI STRUTTURA IMPIALLACCIATI WOOD CARCASS COLOURS WOOD VENEERED



COLORI STRUTTURA E COLORI DIVISORI LACCATI OPACHI CARCASS COLOURS AND MATT LACQUERED DIVIDERS COLOURS



N.B.: PER I COLORI VEDI CATALOGO FINITURE LACCATE (GRUPPO LUBE)
NOTE: FOR COLOURS SEE LACQUERED FINISHES CATALOGUE (GRUPPO LUBE)

COLORI DIVISORI VETRI GLASS DIVIDERS COLOURS



MOBILE DI FINITURA "SIDE"

P 32,8

"SIDE" FINISHING FURNITURE

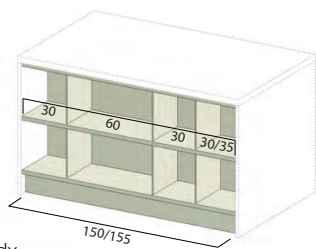
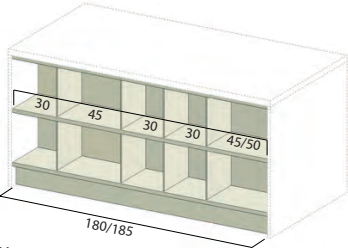
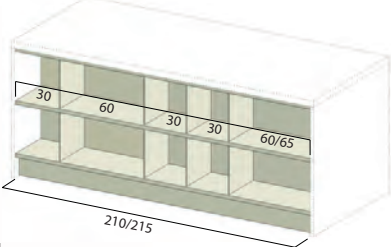
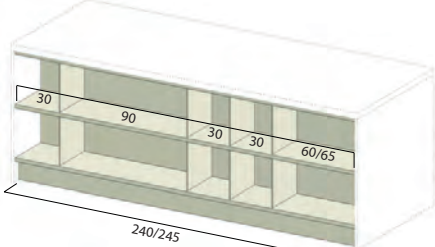
	COD.	WOOD					
<p>mobile L 150/155 P 32,8 con ripiani sp.25 mm 8 vani e 6 divisori in vetro sp.8 mm furniture W 150/155 D 32,8 with shelves th.25 mm 8 compartments and 6 glass dividers th.8 mm</p>  <p>verso dx RH version</p>							
	L 150 per isola for island						
	H 72	E836721511/2	1.290				
	H 75	E836751511/2	1.303				
	H 84	E836841511/2	1.365				
	L 155 per penisola for peninsula						
	H 72	E836721515/6	1.320				
	H 75	E836751515/6	1.334				
H 84	E836841515/6	1.398					
<p>mobile L 180/185 P 32,8 con ripiani sp.25 mm 10 vani e 8 divisori in vetro sp.8 mm furniture W 180/185 D 32,8 with shelves th.25 mm 10 compartments and 8 glass dividers th.8 mm</p>  <p>verso dx RH version</p>							
	L 180 per isola for island						
	H 72	E836721811/2	1.534				
	H 75	E836751811/2	1.551				
	H 84	E836841811/2	1.627				
	L 185 per penisola for peninsula						
	H 72	E836721815/6	1.573				
	H 75	E836751815/6	1.590				
H 84	E836841815/6	1.666					
<p>mobile L 210/215 P 32,8 con ripiani sp.25 mm 10 vani e 8 divisori in vetro sp.8 mm furniture W 210/215 D 32,8 with shelves th.25 mm 10 compartments and 8 glass dividers th.8 mm</p>  <p>verso dx RH version</p>							
	L 210 per isola for island						
	H 72	E836722111/2	1.720				
	H 75	E836752111/2	1.737				
	H 84	E836842111/2	1.825				
	L 215 per penisola for peninsula						
	H 72	E836722115/6	1.750				
	H 75	E836752115/6	1.768				
H 84	E836842115/6	1.855					
<p>mobile L 240/245 P 32,8 con ripiani sp.25 mm 10 vani e 8 divisori in vetro sp.8 mm furniture W 240/245 D 32,8 with shelves th.25 mm 10 compartments and 8 glass dividers th.8 mm</p>  <p>verso dx RH version</p>							
	L 240 per isola for island						
	H 72	E836722411/2	1.894				
	H 75	E836752411/2	1.914				
	H 84	E836842411/2	1.979				
	L 245 per penisola for peninsula						
	H 72	E836722415/6	1.924				
	H 75	E836752415/6	1.941				
H 84	E836842415/6	1.998					

MOBILE DI FINITURA "SIDE" IN APPOGGIO SU BASI

P 32,8

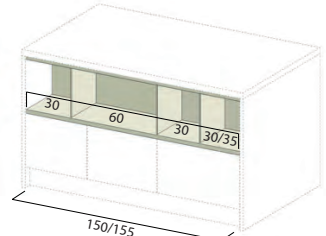
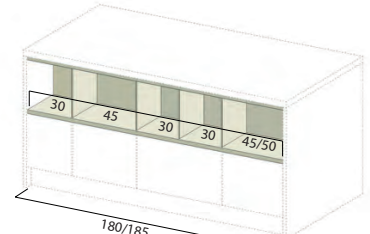
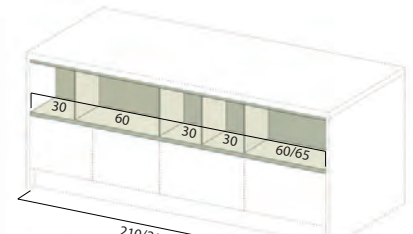
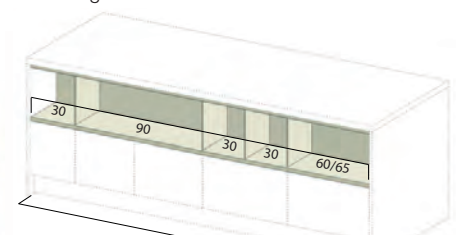
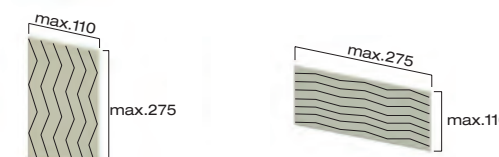

"SIDE" FINISHING FURNITURE RESTING ON BASE UNITS

		COD.	WOOD						
<p>mobile L 150/155 P 32,8 con ripiano sp.25 mm 4 vani e 3 divisori in vetro sp.8 mm furniture W 150/155 D 32,8 with shelf th.25 mm 4 compartments and 3 glass dividers th.8 mm</p>  <p>verso dx RH version</p>	L 150 per isola for island								
	H 36	E83636151/2	824						
	H 37,5	E83637151/2	861						
	H 42	E83642151/2	881						
	H 48	E83648151/2	905						
	L 155 per penisola for peninsula								
	H 36	E836361515/6	841						
	H 37,5	E836371515/6	878						
	H 42	E836421515/6	898						
	H 48	E836481515/6	925						
<p>mobile L 180/185 P 32,8 con ripiano sp.25 mm 5 vani e 4 divisori in vetro sp.8 mm furniture W 180/185 D 32,8 with shelf th.25 mm 5 compartments and 4 glass dividers th.8 mm</p>  <p>verso dx RH version</p>	L 180 per isola for island								
	H 36	E83636181/2	928						
	H 37,5	E83637181/2	968						
	H 42	E83642181/2	993						
	H 48	E83648181/2	1.022						
	L 185 per penisola for peninsula								
	H 36	E836361815/6	956						
	H 37,5	E836371815/6	989						
	H 42	E836421815/6	1.017						
	H 48	E836481815/6	1.050						
<p>mobile L 210/215 P 32,8 con ripiano sp.25 mm 5 vani e 4 divisori in vetro sp.8 mm furniture W 210/215 D 32,8 with shelf th.25 mm 5 compartments and 4 glass dividers th.8 mm</p>  <p>verso dx RH version</p>	L 210 per isola for island								
	H 36	E83636211/2	1.043						
	H 37,5	E83637211/2	1.084						
	H 42	E83642211/2	1.110						
	H 48	E83648211/2	1.144						
	L 215 per penisola for peninsula								
	H 36	E836362115/6	1.057						
	H 37,5	E836372115/6	1.100						
	H 42	E836422115/6	1.127						
	H 48	E836482115/6	1.164						
<p>mobile L 240/245 P 32,8 con ripiano sp.25 mm 5 vani e 4 divisori in vetro sp.8 mm furniture W 240/245 D 32,8 with shelves th.25 mm 5 compartments and 4 glass dividers th.8 mm</p>  <p>verso dx RH version</p>	L 240 per isola for island								
	H 36	E83636241/2	1.147						
	H 37,5	E83637241/2	1.191						
	H 42	E83642241/2	1.221						
	H 48	E83648241/2	1.261						
	L 245 per penisola for peninsula								
	H 36	E836362415/6	1.164						
	H 37,5	E836372415/6	1.208						
	H 42	E836422415/6	1.241						
	H 48	E836482415/6	1.281						
<p>fianco di finitura sp.2,2 come anta rifinito su 2 lati finishing side panel TH. 2,2 same colour as door finish on 2 sides</p> 	al mq per m ²								
	venatura verticale vertical grain	E836852SW	296						
	venatura orizzontale horizontal grain	E836852TW	296						

MOBILE DI COMPLEMENTO "MIXO"

P 50



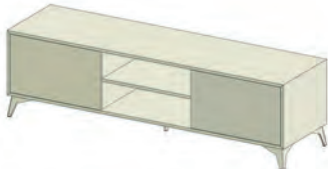

"MIXO" ACCESSORY FURNITURE

	COD.	MELAMINICO					
<p>mobile H 52,6 P 50 L 138,7 2 ante H 36 L 45 apertura push-pull 2 vani L 45 furniture H 52,6 D 50 W 138,7 2 doors H 36 W 45 push-pull opening 2 compartments W 45</p> 							
	<p>Tipo 1 Type 1 H 52,6 L 138,7</p>	EMIXO001	633				
	<p>mag.passacavo surcharge wire-threading</p>		+94				
<p>mobile H 52,6 P 50 L 138,7 2 ante H 36 L 45 apertura push-pull 1 cassetto H 18 L 45 apertura TIP-ON - 1 vano L 45 furniture H 52,6 D 50 W 138,7 2 doors H 36 W 45 push-pull opening 1 drawer H 18 W 45 TIP-ON opening - 1 compartment W 45</p> 							
	<p>Tipo 2 Type 2 H 52,6 L 138,7</p>	EMIXO002	783				
	<p>mag.passacavo surcharge wire-threading</p>		+94				
<p>mobile H 52,6 P 50 L 138,7 2 ante H 36 L 45 apertura push-pull 2 cassetti H 18 L 45 apertura TIP-ON furniture H 52,6 D 50 W 138,7 2 doors H 36 W 45 push-pull opening 2 drawers H 18 W 45 TIP-ON opening</p> 							
	<p>Tipo 3 Type 3 H 52,6 L 138,7</p>	EMIXO003	838				
	<p>mag.passacavo surcharge wire-threading</p>		+94				
<p>mobile H 52,6 P 50 L 183,7 2 ante H 36 L 60 apertura push-pull 2 vani L 60 furniture H 52,6 D 50 W 183,7 2 doors H 36 W 60 push-pull opening 2 compartments W 60</p> 							
	<p>Tipo 4 Type 4 H 52,6 L 183,7</p>	EMIXO011	672				
	<p>mag.passacavo surcharge wire-threading</p>		+94				

MOBILE DI COMPLEMENTO "MIXO"





P 50

"MIXO" ACCESSORY FURNITURE

	COD.	MELA-MINICO						
<p>mobile H 52,6 P 50 L 183,7 2 ante H 36 L 60 apertura push-pull 1 cassetto H 18 L 60 apertura TIP-ON - 1 vano L 60 furniture H 52,6 D 50 W 183,7 2 doors H 36 W 60 push-pull opening 1 drawer H 18 W 60 TIP-ON opening - 1 compartment W 60</p> 								
	<p>Tipo 5 Type 5 H 52,6 L 183,7</p> <p>EMIXO012 826</p> <p>mag.passacavo surcharge wire-threading</p> <p>+94</p>							
<p>mobile H 52,6 P 50 L 183,7 2 ante H 36 L 60 apertura push-pull 2 cassetti H 18 L 60 apertura TIP-ON furniture H 52,6 D 50 W 183,7 2 doors H 36 W 60 push-pull opening 2 drawers H 18 W 60 TIP-ON opening</p> 								
	<p>Tipo 6 Type 6 H 52,6 L 183,7</p> <p>EMIXO013 883</p>							
<p>mobile H 76,6 P 50 L 138,7 3 ante H 60 L 45 apertura push-pull furniture H 76,6 D 50 W 138,7 3 doors H 60 W 45 push-pull opening</p> 								
	<p>Tipo 7 Type 7 H 76,6 L 138,7</p> <p>EMIXO021 677</p>							
<p>mobile H 76,6 P 50 L 138,7 2 ante H 60 L 45 apertura push-pull 1 cassetto H 24 L 45 apertura TIP-ON - 2 vani L 45 furniture H 76,6 D 50 W 138,7 2 doors H 60 W 45 push-pull opening 1 drawer H 24 W 45 TIP-ON opening - 2 compartments W 45</p> 								
	<p>Tipo 8 Type 8 H 76,6 L 138,7</p> <p>EMIXO022 909</p> <p>mag.passacavo surcharge wire-threading</p> <p>+94</p>							

MOBILE DI COMPLEMENTO "MIXO"



"MIXO" ACCESSORY FURNITURE

	COD.	MELA-MINICO					
<p>mobile H 76,6 P 50 L 138,7 2 ante H 60 L 45 apertura push-pull 2 cassetti H 18 L 45 apertura TIP-ON 1 cassetto H 24 L 45 apertura TIP-ON furniture H 76,6 D 50 W 138,7 - 2 doors H 60 W 45 push-pull opening 2 drawers H 18 W 45 TIP-ON opening - 1 drawer H 24 W 45 TIP-ON opening</p> 							
<p>Tipo 9 Type 9 H 76,6 L 138,7</p>	EMIXO023	1.033					
<p>mobile H 76,6 P 50 L 183,7 4 ante H 60 L 45 apertura push-pull furniture H 76,6 D 50 W 183,7 4 doors H 60 W 45 push-pull opening</p> 							
<p>Tipo 10 Type 10 H 76,6 L 183,7</p>	EMIXO031	799					
<p>mobile H 76,6 P 50 L 183,7 3 ante H 60 L 45 apertura push-pull 1 cassetto H 24 L 45 apertura TIP-ON - 2 vani L 45 furniture H 76,6 D 50 W 183,7 3 doors H 60 W 45 push-pull opening 1 drawer H 24 W 45 TIP-ON opening - 2 compartments W 45</p> 							
<p>Tipo 11 Type 11 H 76,6 L 183,7 mag.passacavo surcharge wire-threading</p>	EMIXO032	993					
		+94					
<p>mobile H 76,6 P 50 L 183,7 3 ante H 60 L 45 apertura push-pull 2 cassetti H 18 L 45 apertura TIP-ON 1 cassetto H 24 L 45 apertura TIP-ON furniture H 76,6 D 50 W 183,7 - 3 doors H 60 W 45 push-pull opening 2 drawers H 18 W 45 TIP-ON opening - 1 drawer H 24 W 45 TIP-ON opening</p> 							
<p>Tipo 12 Type 12 H 76,6 L 183,7</p>	EMIXO033	1.114					

MOBILE DI COMPLEMENTO "MIXO"

P 50

"MIXO" ACCESSORY FURNITURE

	COD.	MELA-MINICO						
<p>mobile H 136,6 P 50 L 93,7 4 ante H 60 L 45 apertura push-pull furniture H 136,6 D 50 W 93,7 4 doors H 60 W 45 push-pull opening</p> 								
<p>Tipo 13 Type 13 H 136,6 L 93,7</p>								
	EMIXO041	741						
<p>mobile H 136,6 P 50 L 123,7 4 ante H 60 L 60 apertura push-pull furniture H 136,6 D 50 W 123,7 4 doors H 60 W 60 push-pull opening</p> 								
<p>Tipo 14 Type 14 H 136,6 L 123,7</p>								
	EMIXO042	925						





LIVING

Spazi coordinati per avere un solo ambiente per cucinare, ricevere gli amici, pranzare e rilassarsi è una soluzione al desiderio di vivere la casa più liberamente, secondo stili di vita contemporanei, integrando cucina e living all'insegna di un nuovo linguaggio progettuale.

Coordinated spaces that create a single environment in which to cook, receive friends and relax is a solution that allows you to experience the home more freely.

In line with contemporary lifestyles, this solution integrates the kitchen and living area to create a new design language

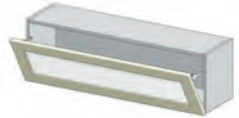
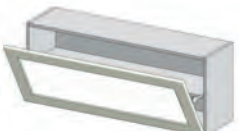







Per la modulistica completa dei pensili P 33 consultare la sezione "Pensili" For complete modularity of wall units D 33 see "Wall units" section		COD.	NECK	NECK	NECK	BRIDGE/HEAD		
			MELAMI- NICO KT5	LACCATO KT6	WOOD KT4	MELAMI- NICO KT1-KT8	LACCATO KT2-KT9	WOOD KT0-KT7
 <p>pensile H 36 apertura a vasistas con push-pull (opz.996) N.B.: per la versione Head viene realizzato senza maniglia wall unit H 36 flap door with push-pull opening (code 996) Note: realized without handle for Head version</p>	L 60	G2106600	146	156	187	146	156	187
	L 90	G2106900	224	239	282	224	239	282
	L 120	G2107200	254	272	—	254	272	—
 <p>pensile H 48 apertura a vasistas con push-pull (opz.996) N.B.: per la versione Head viene realizzato senza maniglia wall unit H 48 flap door with push-pull opening (code 996) Note: realized without handle for Head version</p>	L 60	G2123600	226	239	278	226	239	278
	L 90	G2123900	246	265	319	246	265	319
	L 120	G2124200	278	305	—	278	305	—
 <p>pensile H 36 anta vetro apertura a vasistas con push-pull (opz.996) wall unit H 36 glass door flap door with push-pull opening (code 996)</p>								
	telaio alluminio L 60 aluminium frame	G1107600	235	235	235	235	235	235
	L 90	G1107900	329	329	329	329	329	329
 <p>pensile H 48 anta vetro apertura a vasistas con push-pull (opz.996) wall unit H 48 glass door flap door with push-pull opening (code 996)</p>								
	telaio alluminio L 60 aluminium frame	G1125600	322	322	322	322	322	322
	L 90	G1125900	362	362	362	362	362	362
 <p>mensola in appoggio per pensile finitura come anta support shelf for wall unit same finish as door</p>	P 33,1 sp.1,8 al ml melaminico L max 275	TLE183	51	—	—	51	—	—
	P 33,1 sp.1,8 al ml impiallacciato L max 275	TLH183W	—	—	88	—	—	88
	P 33,2 sp.1,9 al ml laccato L max 275	TLC193	—	61	—	—	61	—
	P 33,1 sp.3,8 al ml melaminico L max 275	091528	122	—	—	122	—	—
	P 33,1 sp.3,8 al ml impiallacciato L max 275	0917234W	—	—	248	—	—	248
	P 33,2 sp.3,8 al ml laccato L max 275	0917340	—	184	—	—	184	—
 <p>maggiorazione per fianchi di struttura come anta (cadauno) surcharge for carcass sides same finish as door (each)</p>	PENSILE WALL UNIT							
	36X31		+24	+28	+34	+24	+28	+34
	48X31		+26	+30	+40	+26	+30	+40

BASI LIVING con piedi H 2,5

LIVING AREA BASE UNITS with feet H 2,5





H 22,7 - 40 - 53,5 P 50

Le basi non sono comprensive di top - N.B.: cerniere ammortizzate di serie The base units do not include the tops - Note: standard blumotion hinges		COD.	NECK	NECK	NECK			
			MELAMI- NICO KT5	LACCATO KT6	WOOD KT4			
 <p>base H 22,7 1 cassetto H 16,9 base unit H 22,7 1 drawer H 16,9</p>	L 45	GBL03450	172	176	210			
	L 60	GBL03600	186	192	228			
	L 90	GBL03900	212	220	263			
	L 120	GBL04200	318	323	—			
 <p>base H 40 1 anta H 34,2 base unit H 40 1 door H 34,2</p>	L 45	GBL21451/2	141	150	180			
	L 60	GBL21601/2	146	157	196			
 <p>base H 40 2 ante H 34,2 base unit H 40 2 doors H 34,2</p>	L 90	GBL21900	209	227	271			
	L 120	GBL22200	239	263	323			
 <p>base H 40 1 cestone H 34,2 base unit H 40 1 deep drawer H 34,2</p>	L 45	GBL25450	185	195	237			
	L 60	GBL25600	204	215	271			
	L 90	GBL25900	238	255	315			
	L 120	GBL26200	332	353	—			
 <p>base H 40 2 cassetti H 16,9 base unit H 40 2 drawers H 16,9</p>	L 45	GBL23450	228	239	289			
	L 60	GBL23600	252	266	317			
	L 90	GBL23900	286	305	375			
	L 120	GBL24200	398	410	—			
 <p>base H 53,5 1 anta H 47,7 base unit H 53,5 1 door H 47,7</p>	L 45	GBL31451/2	160	171	207			
	L 60	GBL31601/2	160	174	229			

BASI LIVING con piedi H 2,5

H 53,5 P 50





LIVING AREA BASE UNITS with feet H 2,5

Le basi non sono comprensive di top - N.B.: cerniere ammortizzate di serie The base units do not include the tops - Note: standard blumotion hinges		COD.	NECK	NECK	NECK			
			MELAMI- NICO KT5	LACCATO KT6	WOOD KT4			
 <p>base H 53,5 2 ante H 47,7 base unit H 53,5 2 doors H 47,7</p>	L 90	GBL31900	220	241	319			
	L 120	GBL32200	254	282	399			
 <p>base H 53,5 1 cestone H 47,7 base unit H 53,5 1 deep drawer H 47,7</p>	L 45	GBL35450	189	201	250			
	L 60	GBL35600	208	221	287			
	L 90	GBL35900	243	264	341			
	L 120	GBL36200	329	349	—			
 <p>top living finitura come anta worktop living same finish as door</p>								
 <p>maggiorazione per fianchi di struttura come anta (cadauno) surcharge for carcass sides same finish as door (each)</p>								
 <p>fianco living lateral finish panel for living base unit</p>								

BASI SOSPENSE LIVING con Attaccaglie e Barre Fissaggio a parete

H 37,5 - 51 P 50







HANGING LIVING BASE UNITS with Hangers and Rods for wall mounting

Le basi non sono comprensive di top - N.B.: cerniere ammortizzate di serie The base units do not include the tops - Note: standard blumotion hinges		COD.	NECK	NECK	NECK			
			MELAMI- NICO KT5	LACCATO KT6	WOOD KT4			
 <p>base H 37,5 1 anta H 34,2 base unit H 37,5 1 door H 34,2</p>	L 45	GBL71451/2	138	147	173			
	L 60	GBL71601/2	150	161	193			
	 <p>base H 37,5 2 ante H 34,2 base unit H 37,5 2 doors H 34,2</p>	L 90	GBL71900	202	220	262		
L 120		GBL72200	234	258	308			
 <p>base H 37,5 1 cestone H 34,2 base H 37,5 1 deep drawer H 34,2</p>		L 45	GBL75450	185	194	229		
	L 60	GBL75600	200	207	264			
	L 90	GBL75900	237	254	308			
	L 120	GBL76200	333	354	—			
	 <p>base H 51 1 anta H 47,7 base unit H 51 1 door H 47,7</p>	L 45	GBL81451/2	157	169	200		
L 60		GBL81601/2	161	172	226			
 <p>base H 51 2 ante H 47,7 base unit H 51 2 doors H 47,7</p>		L 90	GBL81900	213	235	310		
	L 120	GBL82200	249	277	384			
	 <p>base H 51 1 cestone H 47,7 base unit H 51 1 deep drawer H 47,7</p>	L 45	GBL85450	188	199	243		
L 60		GBL85600	204	214	280			
L 90		GBL85900	242	263	334			
L 120		GBL86200	328	349	—			

BASI LIVING CON ZOCCOLO H 13

H 33,2 - 50,5 - 64 P 59,5







LIVING AREA BASE UNITS WITH PLINTH H 13

Le basi non sono comprensive di top - N.B.: cassetti e cestoni ad estrazione totale con blumotion The base units do not include the tops - Note: fully extending drawers and deep drawers with blumotion system		COD.	NECK	NECK	NECK			
			MELAMI- NICO KT5	LACCATO KT6	WOOD KT4			
 <p>base H 33,2 1 cassetto H 16,9 base unit H 33,2 1 drawer H 16,9</p>	L 45	G4203450	147	152	170			
	L 60	G4203600	167	172	190			
	L 90	G4203900	204	212	234			
	L 120	G4204200	242	256	—			
 <p>base H 50,5 1 anta H 34,2 base unit H 50,5 1 door H 34,2</p>	L 45	G4026451/2	144	153	166			
	L 60	G4026601/2	164	175	196			
 <p>base H 50,5 2 ante H 34,2 base unit H 50,5 2 doors H 34,2</p>	L 90	G4026900	219	236	268			
	L 120	G4027200	252	274	320			
 <p>base H 50,5 1 cestone H 34,2 base unit H 50,5 1 deep drawer H 34,2</p>	L 45	G4204450	170	180	207			
	L 60	G4204600	190	202	233			
	L 90	G4204900	229	245	288			
	L 120	G4205200	266	287	—			
 <p>base H 50,5 2 cassetti H 16,9 base unit H 50,5 2 drawers H 16,9</p>	L 45	G4204460	216	227	263			
	L 60	G4204610	240	254	293			
	L 90	G4204910	288	307	358			
	L 120	G4205210	354	379	—			
 <p>base H 64 1 anta H 47,7 base unit H 64 1 door H 47,7</p>	L 45	G4028451/2	148	159	179			
	L 60	G4028601/2	167	181	212			

BASI LIVING CON ZOCCOLO H 13

H 64 P 59,5







LIVING AREA BASE UNITS WITH PLINTH H 13

Le basi non sono comprensive di top - N.B.: cassetti e cestoni ad estrazione totale con blumotion The base units do not include the tops - Note: fully extending drawers and deep drawers with blumotion system		COD.	NECK MELAMI- NICO KT5	NECK LACCATO KT6	NECK WOOD KT4			
 <p>base H 64 2 ante H 47,7 base unit H 64 2 doors H 47,7</p>	L 90	G4028900	227	247	295			
	L 120	G4029200	260	286	369			
 <p>base H 64 1 cestone H 47,7 base unit H 64 1 deep drawer H 47,7</p>	L 45	G4205450	174	185	221			
	L 60	G4205600	191	206	250			
	L 90	G4205900	234	254	312			
	L 120	G4206200	273	298	—			
 <p>top living finitura come anta worktop living same finish as door</p>								
 <p>P 59,6 sp.1,8 al ml D 59,6 th.1,8 per lm melaminico L max 275 melamine impiallacciato L max 275 veneered P 59,7 sp.1,9 al ml D 59,7 th.1,9 per lm laccato L max 275 lacquered</p>		TLE186	77	—	—			
			TLH186W	—	—	136		
			TLC196	—	96	—		
 <p>maggiorazione per fianchi di struttura come anta (cadauno) surcharge for carcass sides same finish as door (each)</p>								
 <p>fianco living lateral finish panel for living base unit</p>								
<p>P 59,6 sp.1,8 al ml D 59,6 th.1,8 per ml melaminico melamine impiallacciato veneered P 59,7 sp.1,9 al ml D 59,7 th.1,9 per ml laccato lacquered</p>		TLE186F	77	—	—			
			TLH186FW	—	—	136		
			TLC196F	—	96	—		

BASI LIVING CON ZOCCOLO H 6

H 28,5 - 48 - 57 P 59,5





LIVING AREA BASE UNITS WITH PLINTH H 6

LE BASI NON SONO COMPRENSIVE DI TOP THE BASE UNITS DO NOT INCLUDE THE TOPS		COD.	NECK MELAMI- NICO KT5	NECK LACCATO KT6	NECK WOOD KT4			
 <p>base H 28,5 1 cassetto H 19,2 base unit H 28,5 1 drawer H 19,2</p>	L 45	GB203450	183	185	185			
	L 60	GB203600	208	210	209			
	L 90	GB203900	256	260	262			
	L 120	GB204200	300	310	—			
 <p>base H 48 1 anta H 38,7 base unit H 48 1 door H 38,7</p>	L 45	GB214451/2	173	178	181			
	L 60	GB214601/2	198	209	217			
 <p>base H 48 2 ante H 38,7 base unit H 48 2 doors H 38,7</p>	L 90	GB214900	271	285	297			
	L 120	GB215200	318	332	361			
 <p>base H 48 1 cestone H 38,7 base unit H 48 1 deep drawer H 38,7</p>	L 45	GB204450	225	233	226			
	L 60	GB204600	248	260	260			
	L 90	GB204900	299	315	325			
	L 120	GB205200	348	370	—			
 <p>base H 48 2 cassetti H 19,2 base unit H 48 2 drawers H 19,2</p>	L 45	GB204460	277	280	281			
	L 60	GB204610	311	315	320			
	L 90	GB204910	376	382	396			
	L 120	GB205210	439	453	—			
 <p>base H 57 1 anta H 47,7 base unit H 57 1 door H 47,7</p>	L 45	G4028451/2	168	179	199			
	L 60	G4028601/2	187	201	232			

BASI LIVING CON ZOCCOLO H 6

H 57 P 59,5







LIVING AREA BASE UNITS WITH PLINTH H 6

LE BASI NON SONO COMPRENSIVE DI TOP THE BASE UNITS DO NOT INCLUDE THE TOPS		COD.	NECK MELAMI- NICO KT5	NECK LACCATO KT6	NECK WOOD KT4			
 <p>base H 57 2 ante H 47,7 base unit H 57 2 doors H 47,7</p>	L 90	G4028900	247	267	315			
	L 120	G4029200	280	306	389			
 <p>base H 57 1 cestone H 47,7 base unit H 57 1 deep drawer H 47,7</p>	L 45	G4205450	194	205	241			
	L 60	G4205600	211	226	270			
	L 90	G4205900	254	274	332			
	L 120	G4206200	293	318	—			
 <p>top living finitura come anta worktop living same finish as door</p>	P 59,6 sp.1,8 al ml D 59,6 th.1,8 per lm melaminico L max 275 melamine		TLE186	77	—	—		
	impiallacciato L max 275 veneered		TLH186W	—	—	136		
	P 59,7 sp.1,9 al ml D 59,7 th.1,9 per lm lacquerato L max 275 lacquered		TLC196	—	96	—		
 <p>maggiorazione per fianchi di struttura come anta (cadauno) surcharge for carcass sides same finish as door (each)</p>	BASI BASE UNITS							
	20,2x57,5		+30	+35	+52			
	22,5x57,5		+30	+35	+52			
	37,5x57,5		+30	+35	+52			
	42x57,5		+33	+39	+65			
	51x57,5		+33	+39	+65			

BASI LIVING con piedi H 2,5

H 20,5 - 26,5 - 38,5 P 50







LIVING AREA BASE UNITS with feet H 2,5

Le basi non sono comprensive di top - N.B.: cerniere ammortizzate di serie The base units do not include the tops - Note: standard blumotion hinges		COD.	BRIDGE	BRIDGE	BRIDGE	HEAD	HEAD	HEAD	
			MELAMI- NICO KT1	LACCATO KT2	WOOD KT0	MELAMI- NICO KT8	LACCATO KT9	WOOD KT7	
 <p>base H 20,5 1 cassetto H 18 base unit H 20,5 1 drawer H 18</p>	L 45	EBL03450	145	150	176	160	164	194	
	L 60	EBL03600	163	168	191	180	186	213	
	L 90	EBL03900	192	200	233	216	224	257	
	L 120	EBL04200	277	285	—	306	312	—	
 <p>base H 26,5 1 cassetto H 24 base unit H 26,5 1 drawer H 24</p>	L 45	EBL13450	155	153	195	170	167	214	
	L 60	EBL13600	174	172	212	192	189	235	
	L 90	EBL13900	211	205	260	235	229	284	
	L 120	EBL14200	301	315	—	330	344	—	
 <p>base H 38,5 1 anta H 36 base unit H 38,5 1 door H 36</p>	L 45	EBL21451/2	129	136	164	143	151	181	
	L 60	EBL21601/2	139	149	180	157	167	202	
 <p>base H 38,5 2 ante H 36 base unit H 38,5 2 doors H 36</p>	L 90	EBL21900	196	212	258	225	241	293	
	L 120	EBL22200	231	250	307	266	286	351	
 <p>base H 38,5 1 cestone H 36 base unit H 38,5 1 deep drawer H 36</p>	L 45	EBL25450	176	184	222	191	198	239	
	L 60	EBL25600	190	200	252	208	217	274	
	L 90	EBL25900	217	232	289	241	256	312	
	L 120	EBL26200	324	346	—	354	376	—	
 <p>base H 38,5 2 cassetti H 18 base unit H 38,5 2 drawers H 18</p>	L 45	EBL23450	223	231	278	252	261	314	
	L 60	EBL23600	243	255	302	279	290	347	
	L 90	EBL23900	280	295	362	327	343	409	
	L 120	EBL24200	411	423	—	470	485	—	

BASI LIVING con piedi H 2,5

H 50,5 P 50

LIVING AREA BASE UNITS with feet H 2,5

Le basi non sono comprensive di top - N.B.: cerniere ammortizzate di serie The base units do not include the tops - Note: standard blumotion hinges		COD.	BRIDGE	BRIDGE	BRIDGE	HEAD	HEAD	HEAD		
			MELAMI- NICO KT1	LACCATO KT2	WOOD KT0	MELAMI- NICO KT8	LACCATO KT9	WOOD KT7		
 <p>base H 50,5 1 anta H 48 base unit H 50,5 1 door H 48</p>	L 45	EBL31451/2	150	160	179	165	175	197		
	L 60	EBL31601/2	154	167	202	172	184	223		
 <p>base H 50,5 2 ante H 48 base unit H 50,5 2 doors H 48</p>	L 90	EBL31900	203	223	285	233	252	320		
	L 120	EBL32200	234	259	356	283	294	400		
 <p>base H 50,5 1 cestone H 48 base unit H 50,5 1 deep drawer H 48</p>	L 45	EBL35450	179	189	223	194	204	241		
	L 60	EBL35600	193	206	257	211	224	279		
	L 90	EBL35900	222	241	303	246	264	325		
	L 120	EBL36200	328	346	—	356	375	—		
 <p>top living finitura come anta worktop living same finish as door</p>										
 <p>maggiorazione per fianchi di struttura come anta (cadauno) surcharge for carcass sides same finish as door (each)</p>										
 <p>fianco living lateral finish panel for living base unit</p>										

BASI SOSPENSE LIVING con Attaccaglie

H 36 - 48 P 50

HANGING LIVING BASE UNITS with Hangers







Le basi non sono comprensive di top - N.B.: cerniere ammortizzate di serie
The base units do not include the tops - Note: standard blumotion hinges

		COD.	BRIDGE MELAMI- NICO KT1	BRIDGE LACCATO KT2	BRIDGE WOOD KT0	HEAD MELAMI- NICO KT8	HEAD LACCATO KT9	HEAD WOOD KT7	
 <p>base H 36 1 anta base unit H 36 1 door</p>	L 45	EBL71451/2	127	134	156	141	149	174	
	L 60	EBL71601/2	141	153	173	161	171	195	
 <p>base H 36 2 ante base unit H 36 2 doors</p>	L 90	EBL71900	181	196	240	210	225	275	
	L 120	EBL72200	211	230	280	246	266	324	
 <p>base H 36 1 cestone base H 36 1 deep drawer</p>	L 45	EBL75450	175	183	215	190	197	232	
	L 60	EBL75600	189	199	245	207	217	267	
	L 90	EBL75900	216	231	282	240	255	305	
	L 120	EBL76200	309	330	—	338	360	—	
 <p>base H 48 1 anta base unit H 48 1 door</p>	L 45	EBL81451/2	148	158	172	163	173	190	
	L 60	EBL81601/2	151	164	194	169	181	216	
 <p>base H 48 2 ante base unit H 48 2 doors</p>	L 90	EBL81900	196	216	275	226	245	310	
	L 120	EBL82200	225	250	341	274	285	384	
 <p>base H 48 1 cestone base unit H 48 1 deep drawer</p>	L 45	EBL85450	178	188	205	193	203	223	
	L 60	EBL85600	193	205	239	210	223	261	
	L 90	EBL85900	221	240	284	245	264	307	
	L 120	EBL86200	311	330	—	339	360	—	

BASI LIVING CON ZOCCOLO H 13

H 31 - 37 - 49 P 59,5







LIVING AREA BASE UNITS WITH PLINTH H 13

Le basi non sono comprensive di top - N.B.: cassetti e cestoni ad estrazione totale con blumotion The base units do not include the tops - Note: fully extending drawers and deep drawers with blumotion system		COD.	BRIDGE	BRIDGE	BRIDGE	HEAD	HEAD	HEAD	
			MELAMI- NICO KT1	LACCATO KT2	WOOD KT0	MELAMI- NICO KT8	LACCATO KT9	WOOD KT7	
 <p>base H 31 1 cassetto H 18 base unit H 31 1 drawer H 18</p>	L 45	E4023450	130	133	147	143	148	165	
	L 60	E4023600	145	149	164	161	167	186	
	L 90	E4023900	183	192	207	208	216	231	
	L 120	E4024200	211	223	—	242	255	—	
 <p>base H 37 1 cassetto H 24 base unit H 37 1 drawer H 24</p>	L 45	E4025450	138	144	167	152	159	186	
	L 60	E4025600	167	169	181	179	187	204	
	L 90	E4025900	197	208	231	222	232	254	
	L 120	E4026200	235	241	—	266	273	—	
 <p>base H 49 1 anta H 36 base unit H 49 1 door H 36</p>	L 45	E4026451/2	110	116	137	123	131	154	
	L 60	E4026601/2	121	127	141	135	144	163	
 <p>base H 49 2 ante H 36 base unit H 49 2 doors H 36</p>	L 90	E4026900	179	196	236	210	225	271	
	L 120	E4027200	211	236	282	249	268	325	
 <p>base H 49 1 cestone H 36 base unit H 49 1 deep drawer H 36</p>	L 45	E4204450	139	146	180	153	164	197	
	L 60	E4204600	153	161	202	169	183	224	
	L 90	E4204900	191	206	258	215	229	281	
	L 120	E4205200	231	252	—	262	283	—	
 <p>base H 49 2 cassetti H 18 base unit H 49 2 drawers H 18</p>	L 45	E4204460	185	187	229	208	217	266	
	L 60	E4204610	202	206	255	230	247	300	
	L 90	E4204910	246	258	319	289	306	366	
	L 120	E4205210	307	333	—	370	395	—	

BASI LIVING CON ZOCCOLO H 13

H 61 P 59,5







LIVING AREA BASE UNITS WITH PLINTH H 13

Le basi non sono comprensive di top - N.B.: cassetti e cestoni ad estrazione totale con blumotion The base units do not include the tops - Note: fully extending drawers and deep drawers with blumotion system		COD.	BRIDGE MELAMI- NICO KT1	BRIDGE LACCATO KT2	BRIDGE WOOD KT0	HEAD MELAMI- NICO KT8	HEAD LACCATO KT9	HEAD WOOD KT7	
 <p>base H 61 1 anta H 48 base unit H 61 1 door H 48</p>	L 45	E4028451/2	120	131	153	134	143	170	
	L 60	E4028601/2	129	137	173	142	155	195	
 <p>base H 61 2 ante H 48 base unit H 61 2 doors H 48</p>	L 90	E4028900	199	215	262	225	244	298	
	L 120	E4029200	226	250	330	274	285	374	
 <p>base H 61 1 cestone H 48 base unit H 61 1 deep drawer H 48</p>	L 45	E4205450	153	156	196	162	170	213	
	L 60	E4205600	170	172	221	178	190	243	
	L 90	E4205900	209	219	285	225	245	307	
	L 120	E4206200	241	267	—	272	298	—	
 <p>top living finitura come anta worktop living same finish as door</p>									
 <p>maggiorazione per fianchi di struttura come anta (cadauno) surcharge for carcass sides same finish as door (each)</p>									
 <p>fianco living lateral finish panel for living base unit</p>									

BASI LIVING CON ZOCCOLO H 6

H 24 - 30 - 42 P 59,5

LIVING AREA BASE UNITS WITH PLINTH H 6

LE BASI NON SONO COMPRENSIVE DI TOP THE BASE UNITS DO NOT INCLUDE THE TOPS		COD.	BRIDGE	BRIDGE	BRIDGE	HEAD	HEAD	HEAD	
			MELAMI- NICO KT1	LACCATO KT2	WOOD KT0	MELAMI- NICO KT8	LACCATO KT9	WOOD KT7	
 <p>base H 24 1 cassetto H 18 base unit H 24 1 drawer H 18</p>	L 45	E4023450	150	153	167	163	168	185	
	L 60	E4023600	165	169	184	181	187	206	
	L 90	E4023900	203	212	227	228	236	251	
	L 120	E4024200	231	243	—	262	275	—	
 <p>base H 30 1 cassetto H 24 base unit H 30 1 drawer H 24</p>	L 45	E4025450	158	164	187	172	179	206	
	L 60	E4025600	187	189	201	199	207	224	
	L 90	E4025900	217	228	251	242	252	274	
	L 120	E4026200	255	261	—	286	293	—	
 <p>base H 42 1 anta H 36 base unit H 42 1 door H 36</p>	L 45	E4026451/2	130	136	157	143	151	174	
	L 60	E4026601/2	141	147	161	155	164	183	
 <p>base H 42 2 ante H 36 base unit H 42 2 doors H 36</p>	L 90	E4026900	199	216	256	230	245	291	
	L 120	E4027200	231	256	302	269	288	345	
 <p>base H 42 1 cestone H 36 base unit H 42 1 deep drawer H 36</p>	L 45	E4204450	159	166	200	173	184	217	
	L 60	E4204600	173	181	222	189	203	244	
	L 90	E4204900	211	226	278	235	249	301	
	L 120	E4205200	251	272	—	282	303	—	
 <p>base H 42 2 cassetti H 18 base unit H 42 2 drawers H 18</p>	L 45	E4204460	205	207	249	228	237	286	
	L 60	E4204610	222	226	275	250	267	320	
	L 90	E4204910	266	278	339	309	326	386	
	L 120	E4205210	327	353	—	390	415	—	

LIVING KTA-1



ANTE
doors

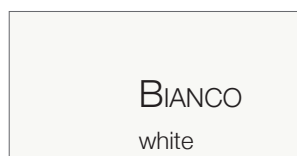

BIANCO
white



ROSSO CARDINALE
cardinal red

STRUTTURA
carcass



BIANCO
white

LIVING KTA-1

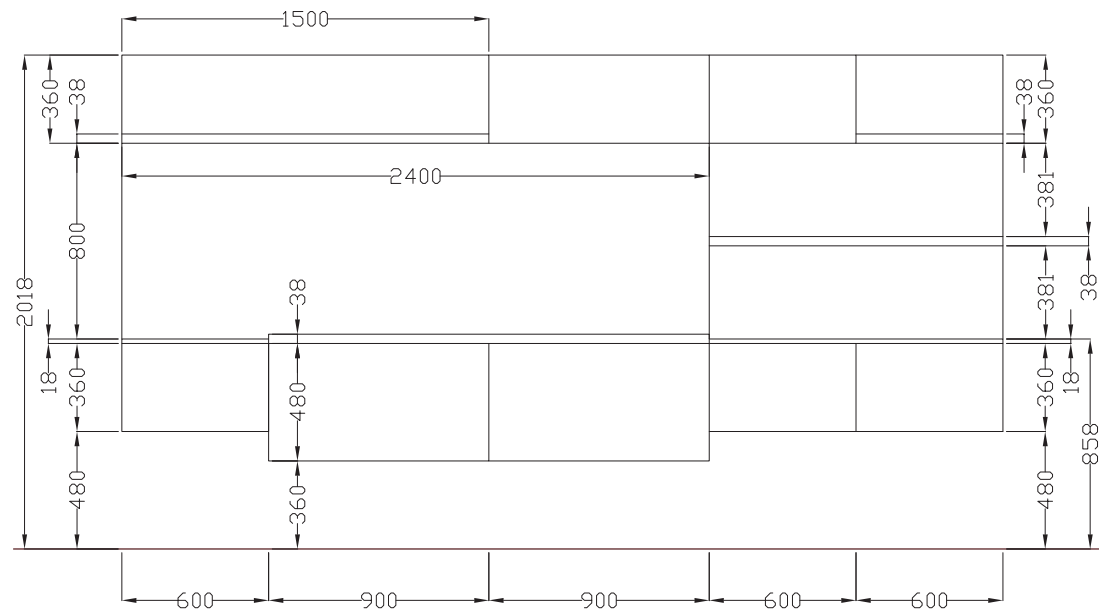

NR. ELEMENTI	DESCRIZIONE	CODICE	€ cad.
1	Pensile L 90 H 36 P 33 ribalta tip-on, fianco come anta	E210091T	177
1	Pensile L 60 H 36 P 33 ribalta tip-on, fianco come anta	E210061T	138
2	Pensile L 60 H 36 P 33 vasistas winch, fianco come anta	G2106600	170
1	Pensile L 60 H 36 P 33 vasistas winch	G2106600	146
2	Base sospesa L 90 H 48 P 59,5 cestone apertura tip-on, fianco come anta	E4310900	296
1	Pannello L 240 H 116 SP. 1,8 melaminico come anta	al mq 094506	121
1	Pannello L 120 H 116 SP. 1,8 melaminico come anta	al mq 094506	121
1	Mensola L 150 P 31 SP. 3,8 melaminico come anta	al ml 091523	116
1	Mensola L 60 P 31 SP. 3,8 melaminico come anta	al ml 091523	116
1	Mensola L 120 P 31 SP. 3,8 melaminico come anta	al ml 091523	116
1	Mensola L 180 P 61 SP. 3,8 melaminico come anta	al ml 091560	152
1	Top living L 60 P 33,1 SP. 1,8 melaminico come anta	al ml TLE183	51
1	Top living L 120 P 33,1 SP. 1,8 melaminico come anta	al ml TLE183	51
1	Asta appendipensili ml 2	08610501	9
TOTALE			2.655
No. of ELEMENTS	DESCRIPTION	CODE	€ each
1	Wall unit W 90 H 36 D 33 flap door, tip-on opening, side same as door	E210091T	177
1	Wall unit W 60 H 36 D 33 flap door, tip-on opening, side same as door	E210061T	138
2	Wall unit W 60 H 36 D 33 flap door winch opening, side same as door	G2106600	170
1	Wall unit W 60 H 36 D 33 flap door winch opening	G2106600	146
2	Hanging base unit W 90 H 48 D 59,5 1 deep drawer, tip-on opening side same as door	E4310900	296
1	Back panel W 240 H 116 D 1,8 melamine same as door	per m ² 094506	121
1	Back panel W 120 H 116 D 1,8 melamine same as door	per m ² 094506	121
1	Shelf W 150 D 31 TH. 3,8 melamine same as door	per lm 091523	116
1	Shelf W 60 D 31 TH. 3,8 melamine same as door	per lm 091523	116
1	Shelf W 120 D 31 TH. 3,8 melamine same as door	per lm 091523	116
1	Shelf W 180 D 61 TH. 3,8 melamine same as door	per lm 091560	152
1	Melamine worktop W 60 D 33,1 TH. 1,8 same as door	per lm TLE183	51
1	Melamine worktop W 120 D 33,1 TH. 1,8 same as door	per lm TLE183	51
1	Wall unit fixing strip lm 2	08610501	9
TOTAL			2.655

LIVING KTA-2



ANTA
door

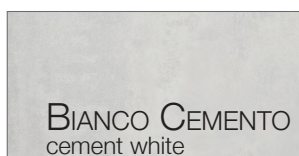

ELEMENTI A GIORNO
open units



STRUTTURA
carcass



LIVING KTA-2

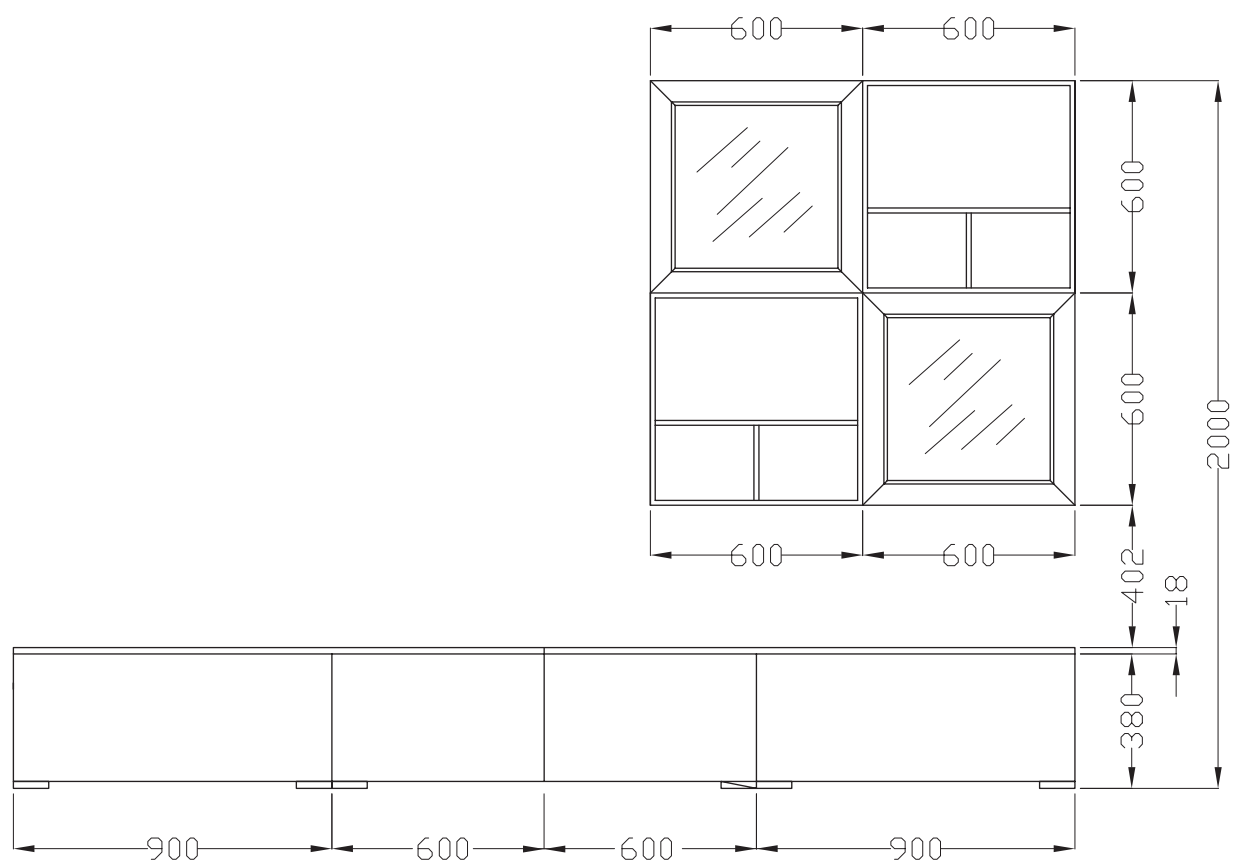

NR. ELEMENTI	DESCRIZIONE	CODICE	€ cad.
2	Base living L 90 H 38 P 50 cestone apertura tip-on, fianco come anta	EBL25900	292
2	Base living L 60 H 38 P 50, cestone apertura tip-on	EBL25600	235
2	Pensile vetro L 60 H 60 P 33 telaio alluminio apertura push-pull	G1062601/2	220
2	Elemento a giorno L 60 H 60 P 31 3 vani laccati opaco	E7701720	314
2	Top melaminico L 150 P 50,1 SP. 1,8 colore come anta	al ml TLE185	68
2	Asta appendipensili ml 2	08610501	9
TOTALE			2.344
No. of ELEMENTS	DESCRIPTION	CODE	€ each
2	Living base unit W 90 H 38 D 50 deep drawer tip-on opening, side same as door	EBL25900	292
2	Living base unit W 60 H 38 D 50 deep drawer tip-on opening	EBL25600	235
2	Glass wall unit W 60 H 60 D 33 aluminium frame, push-pull opening	G1062601/2	220
2	Matt lacquered open unit W 60 H 60 D 31 3 compartments	E7701720	314
2	Melamine worktop W 150 D 50,1 TH. 1,8 same colour as door	per lm TLE185	68
2	Wall unit fixing strip mt. 2	08610501	9
TOTAL			2.344

LIVING KTA-3



ANTE
doors

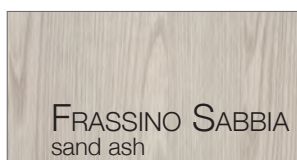

ELEMENTI A GIORNO
open units



STRUTTURE
carcasses



LIVING KTA-3

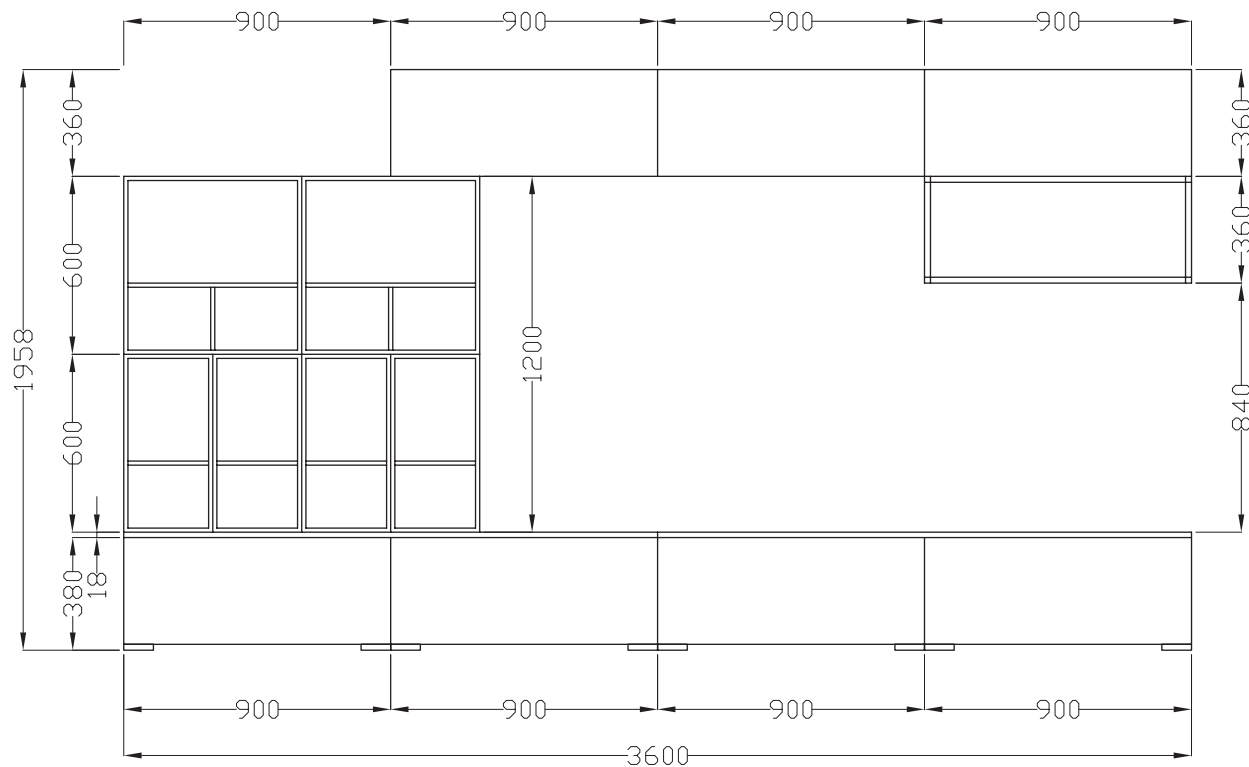

NR. ELEMENTI	DESCRIZIONE	CODICE	€ cad.
2	Pensile L 90 H 36 P 33 ribalta tip-on, fianco come anta	E210091T	177
1	Pensile L 90 H 36 P 33 ribalta tip-on	E210091T	153
2	Elemento a giorno L 60 H 60 P 31 3 vani, laccato opaco	E7701720	314
4	Elemento a giorno L 30 H 60 P 31 2 vani, laccato opaco	E7701733	224
1	Elemento a giorno in melaminico L 90 H 36 P 31 ripiano in vetro	E7861190	298
2	Base living L 90 H 38 P 50 cestone apertura tip-on, fianco come anta	EBL25900	292
2	Base living L 90 H 38 P 50 cestone apertura tip-on	EBL25900	262
2	Top melaminico L 180 P 50,1 SP. 1,8 colore come anta	al ml TLE185	68
3	Asta appendipensili ml 2	08610501	9
TOTALE			3.709
No. of ELEMENTS	DESCRIPTION	CODE	€ each
2	Wall unit W 90 H 36 D 33 tip-on opening, side same as door	E210091T	177
1	Wall unit W 90 H 36 D 33 tip-on opening	E210091T	153
2	Matt lacquered open unit W 60 H 60 D 31 3 compartments	E7701720	314
4	Matt lacquered open unit W 30 H 60 D 31 2 compartments	E7701733	224
1	Metal open unit W 90 H 36 D 31 with glass shelf	E7861190	298
2	Living base unit W 90 H 38 D 50 deep drawer tip-on opening, side same as door	EBL25900	292
2	Living base unit W 90 H 38 D 50 deep drawer tip-on opening	EBL25900	262
2	Melamine worktop W 180 D 50,1 TH. 1,8 same colour as door	per lm TLE185	68
3	Wall unit fixing strip lm 2	08610501	9
TOTAL			3.709

LIVING KTA-4



ANTA
door

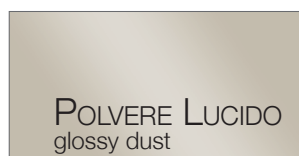

POLVERE LUCIDO
glossy dust

ELEMENTI A GIORNO
open units

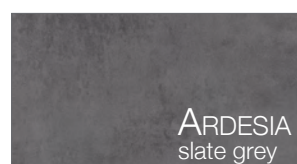

ARDESIA
slate grey

STRUTTURA
carcass

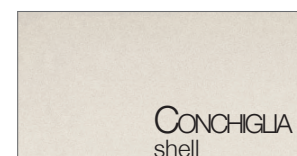

CONCHIGLIA
shell

LIVING KTA-4

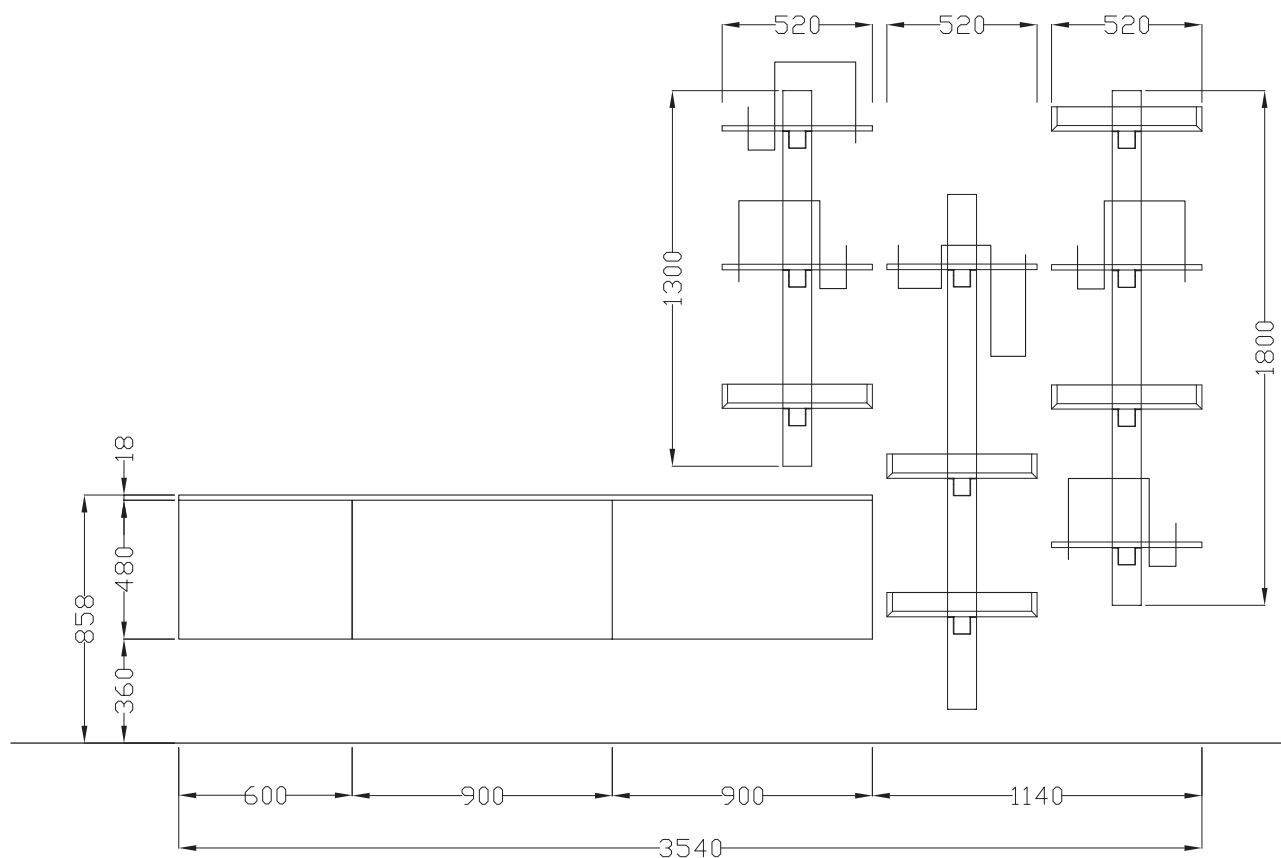

NR. ELEMENTI	DESCRIZIONE	CODICE	€ cad.
1	Base living sospesa L 90 H 48 P 50, 1 cestone apertura tip-on	EBL85900	285
1	Base living sospesa L 90 H 48 P 50, 1 cestone apertura tip-on, fianco come anta	EBL85900	324
1	Base living sospesa L 60 H 48 P 50, 1 cestone apertura tip-on, fianco come anta	EBL85600	289
1	Libreria "TOTEM" L 12 H 130, nero	0890800N	130
2	Libreria "TOTEM" L 12 H 180, nero	0890801N	156
4	Modulo 1 per "TOTEM" L 37,4 H 30,6 P 25	0890810D/S	226
1	Modulo 2 per "TOTEM" L 44 H 38,6 P 25	0890811D/S	241
5	Vaschette TRAYS per "TOTEM" L 52 H 8,4 P 25 in melaminico	0890816	179
1	Top living L 240 P 50,2 SP. 1,9 laccato come anta	al ml TLC195	81
TOTALE			3.575
No. of ELEMENTS	DESCRIPTION	CODE	€ each
1	Hanging living base unit W 90 H 48 D 50, 1 deep drawer tip-on opening	EBL85900	285
1	Hanging living base unit W 90 H 48 D 50, 1 deep drawer tip-on opening, side same as door	EBL85900	324
1	Hanging living base unit W 60 H 48 D 50, 1 deep drawer tip-on opening, side same as door	EBL85600	289
1	"TOTEM" bookcase W 12 H 130, black colours	0890800N	130
2	"TOTEM" bookcase W 12 H 180, black colours	0890801N	156
4	Module 1 for "TOTEM" bookcase W 37,4 H 30,6 D 25	0890810D/S	226
1	Module 2 for "TOTEM" bookcase W 44 H 38,6 D 25	0890811D/S	241
5	Melamine TRAYS for "TOTEM" bookcase W 52 H 8,4 D 25	0890816	179
1	Living worktop W 240 D 50,2 TH. 1,9 lacquered same as door	per lm TLC195	81
TOTAL			3.575

LIVING KTA-5



ANTA
door

BIANCO ASSOLUTO
OPACO
matt absolute white

ELEMENTI A GIORNO
open units

AZZURRO NUBE
cloud blue

STRUTTURA
carcass

BIANCO
white

LIVING KTA-5

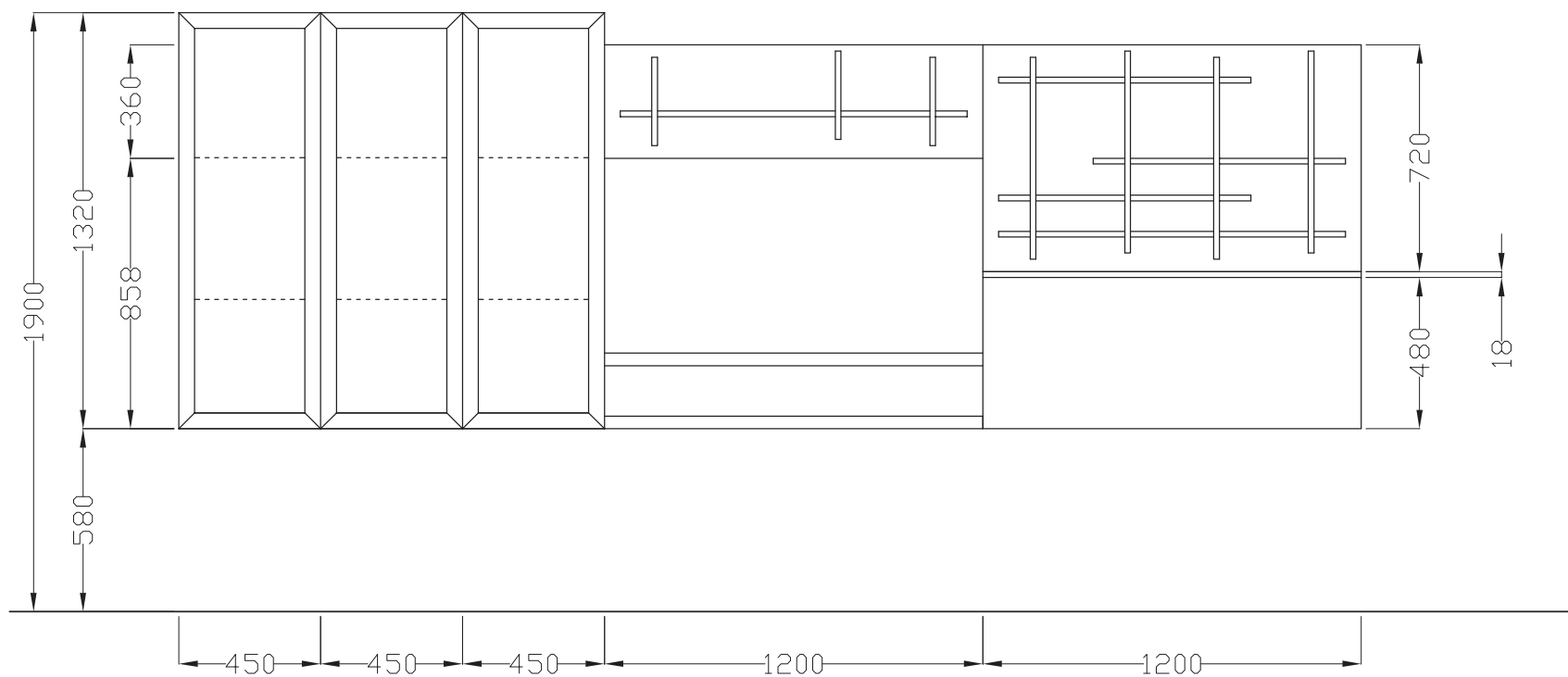

NR. ELEMENTI	DESCRIZIONE	CODICE	€ cad.
2	Pensile L 45 H 132 P 33 anta vetro alluminio, apertura push-pull, ripiani vetro, fianco come anta	G1027451/2	424
1	Pensile L 45 H 132 P 33 anta vetro alluminio apertura push-pull, ripiani vetro	G1027451/2	374
6	Profilo led glass-8 ITALPEK per ripiano vetro L 45	08616263	56
1	Alimentatore 50W per luce glass-8 ITALPEK	08616192A	52
1	Schienale "WEAVE" L 120 H 36 laccato come anta con mensole laccate opache	E83536120	298
1	Schienale "WEAVE" L 120 H 72 laccato come anta con mensole laccate opache	E83572120	684
1	Base living sospesa L 120 H 48 P 50, 1 cestone, fianchi come anta	EBL86200	408
1	Pannello L 120 H 85,8 SP. 1,8 impiallacciato come anta	al mq 094530	161
2	Mensole L 120 P 31 SP. 3,8 impiallacciato come anta	al ml 091733	171
1	Asta appendipensili ml 2	08610501	9
TOTALE			3.586

No. of ELEMENTS	DESCRIPTION	CODE	€ each
2	Wall unit W 45 H 132 D 33 aluminium framed glass door, push-pull opening, glass shelves, side same as door	G1027451/2	424
1	Wall unit W 45 H 132 D 33 aluminium framed glass door, push-pull opening, glass shelves	G1027451/2	374
6	ITALPEK glass-8 led profile for shelf W 45	08616263	56
1	ITALPEK power supply 50w for glass-8 light	08616192A	52
1	"WEAVE" back panel W 120 H 36 lacquered as door, matt lacquered shelves	E83536120	298
1	"WEAVE" back panel W 120 H 72 lacquered as door, matt lacquered shelves	E83572120	684
1	Hanging living base unit W 120 H 48 D 50, 1 deep drawer sides same as door	EBL86200	408
1	Veneered back panel W 120 H 85,8 TH.1,8 same colour as door	per m ² 094530	161
2	Veneered shelves W 120 D 31 TH.3,8 same colour as door	per lm 091733	171
1	Wall unit fixing strip lm 2	08610501	9
TOTAL			3.586

COMPOSIZIONE BASSA L 255 (con gola L 260)

LOW COMPOSITION W 255 (with finger rail W 260)



COMPOSIZIONE BASSA L 300 (con gola L 305)

LOW COMPOSITION W 300 (with finger rail W 305)



COMPOSIZIONE BASSA L 255 (con gola L 260)

(IVA e contributo RAEE esclusi)

LOW COMPOSITION W 255 (with finger rail W 260)

(VAT and WEEE fee excluded)

COMPONENTI COMPONENTS	VERSIONI VERSIONS
<p>Colonna 60 frigo-freezer 230 classe A+ 60 cm column fridge-freezer 230 class "A+"</p> <p>Base 45 2 cassetti e cestone 45 cm base unit with 2 drawers and deep drawer</p> <p>Base 60 forno statico nero con ventilazione tangenziale di raffreddamento static oven with orbital cooling ventilation 60 base unit</p> <p>Piano cottura 60 4 gas inox con valvola di sicurezza 60 cm stainless steel hob with 4 gas burners with safety valve</p> <p>Sottolavello 90 90 cm sink unit</p> <p>Lavello ad incasso 86 x 50 1 vasca inox prelucidato 86x50 cm built-in sink with 1 stainless steel bowl</p> <p>Pensile 45 H 72 45 cm wall unit H 72</p> <p>Cappa 60 aspirante estraibile H 63 2 motori 60 cm hood slide-out ducting H 63 2 motors</p> <p>Scolapiatti 90 H 72 90 cm plate rack H 72</p> <p>Top 195 P 61 in laminato H 4 195 cm laminate worktop D 61 H 4</p> <p>Asta appendipensili ml 2 2 lm wall unit fixing strip</p> <p>(Elettrodomestici Beko) (Beko appliances)</p>	<p>MELAMINICO</p> <p>BRIDGE € 3.005</p> <p>HEAD € 3.207</p> <p>NECK € 3.380</p> <p>LACCATO</p> <p>BRIDGE € 3.175</p> <p>HEAD € 3.388</p> <p>NECK € 3.609</p> <p>IMPIALLACCIATO</p> <p>BRIDGE € 3.660</p> <p>HEAD € 3.902</p> <p>NECK € 4.240</p> <p>Maggiorazione per forno statico inox + € 65 surcharges for stainless steel static oven</p>

COMPOSIZIONE BASSA L 300 (con gola L 305)

(IVA e contributo RAEE esclusi)

LOW COMPOSITION W 300 (with finger rail W 305)

(VAT and WEEE fee excluded)

COMPONENTI COMPONENTS	VERSIONI VERSIONS
<p>Colonna 60 frigo-freezer 230 classe A+ 60 cm column fridge-freezer 230 class "A+"</p> <p>Base 60 2 cassetti e cestone 60 cm base unit with 2 drawers and deep drawer</p> <p>Base 60 forno statico nero con ventilazione tangenziale di raffreddamento static oven with orbital cooling ventilation 60 base unit</p> <p>Piano cottura 60 4 gas inox con valvola di sicurezza 60 cm stainless steel hob with 4 gas burners with safety valve</p> <p>Base 60 60 cm base unit</p> <p>Sottolavello 60 60 cm sink unit</p> <p>Lavello ad incasso 86 x 50 1 vasca inox prelucidato 86x50 cm built-in sink with 1 stainless steel bowl</p> <p>Pensile 60 H 72 60 cm wall unit H 72</p> <p>Cappa 60 aspirante estraibile H 63 2 motori 60 cm hood slide-out ducting H 63 2 motors</p> <p>Pensile 60 H 72 60 cm wall unit H 72</p> <p>Scolapiatti 60 H 72 60 cm plate rack H 72</p> <p>Top 240 P 61 in laminato H 4 240 cm laminate worktop D 61 H 4</p> <p>Asta appendipensili ml 4 4 lm wall unit fixing strip</p> <p>(Elettrodomestici Beko) (Beko appliances)</p>	<p>MELAMINICO</p> <p>BRIDGE € 3.226</p> <p>HEAD € 3.453</p> <p>NECK € 3.634</p> <p>LACCATO</p> <p>BRIDGE € 3.422</p> <p>HEAD € 3.658</p> <p>NECK € 3.894</p> <p>IMPIALLACCIATO</p> <p>BRIDGE € 3.992</p> <p>HEAD € 4.268</p> <p>NECK € 4.604</p> <p>Maggiorazione per forno statico inox + € 65 surcharges for stainless steel static oven</p>

COMPOSIZIONE ALTA L 300 (con gola L 305)

HIGH COMPOSITION W 300 (with finger rail W 305)



COMPOSIZIONE BASSA L 360 (con gola L 365)

LOW COMPOSITION W 360 (with finger rail W 365)



COMPOSIZIONE ALTA L 300 (con gola L 305)

(IVA e contributo RAEE esclusi)

HIGH COMPOSITION W 300 (with finger rail W 305)

(VAT and WEEE fee excluded)

COMPONENTI COMPONENTS	VERSIONI VERSIONS
<p>Colonna 60 frigo-freezer 230 classe A+ 60 cm column fridge-freezer 230 class "A+"</p> <p>Base 60 2 cassetti e cestone 60 cm base unit with 2 drawers and deep drawer</p> <p>Base 60 forno statico nero con ventilazione tangenziale di raffreddamento static oven with orbital cooling ventilation 60 base unit</p> <p>Piano cottura 60 4 gas inox con valvola di sicurezza 60 cm stainless steel hob with 4 gas burners with safety valve</p> <p>Base 60 60 cm base unit</p> <p>Sottolavello 60 60 cm sink unit</p> <p>Lavello ad incasso 86 x 50 1 vasca inox prelucidato 86x50 cm built-in sink with 1 stainless steel bowl</p> <p>Pensile 60 H 72 60 cm wall unit H 72</p> <p>Cappa 60 aspirante estraibile H 63 2 motori 60 cm hood slide-out ducting H 63 2 motors</p> <p>Pensile 60 H 96 60 cm wall unit H 96</p> <p>Scolapiatti 60 H 96 60 cm plate rack H 96</p> <p>Top 240 P 61 in laminato H 4 240 cm laminate worktop D 61 H 4</p> <p>Mensola 120 P 31 sp. 3,8 120 cm shelf D 31 sp. 3,8</p> <p>Asta appendipensili ml 4 4 lm wall unit fixing strip</p>	<p>MELAMINICO</p> <p>BRIDGE € 3.398</p> <p>HEAD € 3.624</p> <p>NECK € 3.825</p> <p>LACCATO</p> <p>BRIDGE € 3.610</p> <p>HEAD € 3.846</p> <p>NECK € 4.109</p> <p>IMPIALLACCIATO</p> <p>BRIDGE € 4.223</p> <p>HEAD € 4.500</p> <p>NECK € 4.871</p> <p>Maggiorazione per forno statico inox + € 65 surcharges for stainless steel static oven</p>
<p>(Elettrodomestici Beko) (Beko appliances)</p>	

COMPOSIZIONE BASSA L 360 (con gola L 365)

(IVA e contributo RAEE esclusi)

LOW COMPOSITION W 360 (with finger rail W 365)

(VAT and WEEE fee excluded)

COMPONENTI COMPONENTS	VERSIONI VERSIONS
<p>Colonna 60 frigo-freezer 230 classe A+ 60 cm column fridge-freezer 230 class "A+"</p> <p>Colonna 60 con cestone, forno statico nero con ventilazione tangenziale di raffreddamento 60 column with deep drawer configured for static oven with orbital cooling ventilation</p> <p>Base 90 2 cassetti + cestone predisposto P.C. 90 cm base unit with 2 drawers + deep drawer configured for hob</p> <p>Piano cottura 60 4 gas inox con valvola di sicurezza 60 cm stainless steel hob with 4 gas burners with safety valve</p> <p>Base 60 60 cm base unit</p> <p>Sottolavello 90 90 cm sink unit</p> <p>Lavello ad incasso 86 x 50 1 vasca inox prelucidato 86x50 cm built-in sink with 1 stainless steel bowl</p> <p>Pensile 60 H 72 60 cm wall unit H 72</p> <p>Cappa 90 sempione acciaio inox satinato + vetro 90 cm sempione hood brushed stainless steel + glass</p> <p>Pensile 60 H 72 60 cm wall unit H 72</p> <p>Scolapiatti 90 H 72 90 cm plate rack H 72</p> <p>Top 240 P 61 in laminato H 4 240 cm laminate worktop D 61 H 4</p> <p>Top 60 P 61 in laminato H 4 60 cm laminate worktop D 61 H 4</p> <p>Asta appendipensili ml 4 4 lm wall unit fixing strip</p>	<p>MELAMINICO</p> <p>BRIDGE € 3.594</p> <p>HEAD € 3.832</p> <p>NECK € 3.998</p> <p>LACCATO</p> <p>BRIDGE € 3.801</p> <p>HEAD € 4.040</p> <p>NECK € 4.278</p> <p>IMPIALLACCIATO</p> <p>BRIDGE € 4.388</p> <p>HEAD € 4.660</p> <p>NECK € 4.979</p> <p>Maggiorazione per forno statico inox + € 65 surcharges for stainless steel static oven</p>
<p>(Elettrodomestici Beko) (Beko appliances)</p>	

