



**MAGGIORAZIONE  
SURCHARGE**

**+ 8%**

**DAL 23 GENNAIO 2023  
FROM JANUARY 23, 2023**

**SMART**

listino 2021

moderno

# CONDIZIONI GENERALI DI VENDITA

## DECORRENZA

Il presente listino sostituisce ed annulla tutti i precedenti.

Non costituisce offerta e può essere modificato, con comunicazione scritta dell'AZIENDA al Cliente, in qualsiasi momento anche senza preavviso.

Le modificazioni o gli aggiornamenti avranno efficacia rispetto a tutti gli ordinativi pervenuti o trasmessi all'AZIENDA dopo la comunicazione scritta di cui sopra.

## PREZZI DI LISTINO E CONDIZIONI DI PAGAMENTO

I prezzi sono quotati al pubblico I.V.A. e contributo RAEE esclusi e si intendono franco fabbrica.

Decorso il termine contrattuale di pagamento l'AZIENDA è autorizzata alla emissione di tratte a saldo di ogni suo avere maggiorate degli interessi, spese e di ogni altro onere accessorio, previa comunicazione al Cliente. In caso di pagamento oltre i termini contrattuali, saranno addebitati gli interessi ai sensi del D.lgs. 231/2002, oltre al recupero di eventuali sconti espressamente concessi in ragione del termine di pagamento.

In caso di mancato pagamento nei tempi contrattuali l'AZIENDA potrà sospendere l'evasione degli ordini in corso previa comunicazione al Cliente.

## CONSEGNA

I termini di consegna vengono computati in giorni lavorativi con decorrenza dal perfezionamento del contratto di vendita, che comunque si intende perfezionato entro 8 giorni dall'invio dell'ordine o comunque entro 8 giorni dall'ultimo chiarimento (se richiesto) fornito dal Cliente. I termini di consegna saranno prorogati automaticamente in dipendenza di avvenimenti non imputabili all'AZIENDA o a cause di forza maggiore. Sono sempre ammesse consegne parziali.

## PRODOTTO

I dati tecnici relativi ai prodotti illustrati nel presente listino sono puramente indicativi come indicativi. L'AZIENDA si riserva la facoltà di apportare tutte le modifiche tecnico-costruttive migliorative del prodotto, senza obbligo di preavviso. La merce potrà tuttavia presentare caratteristiche parzialmente difformi da quelle indicate nel listino e nel catalogo, e comunque non risultare del tutto identica ai campioni che eventualmente fossero stati visionati in occasione della effettuazione dell'ordine, dovendosi riconoscere margini di tolleranza per quanto concerne i colori e le tonalità. La conformità al campione non deve intendersi in senso tassativo. Ciò vale anche per gli elettrodomestici o altri accessori impiegati a corredo delle cucine; questi potranno risultare esteticamente leggermente difformi in base alle marche utilizzate diverse da quelle da catalogo, salvo la sostanziale conformità delle caratteristiche e delle funzioni. Il Cliente potrà richiedere elementi specifici indicandone la marca sempre nell'ambito del ventaglio di offerte dell'AZIENDA non assume alcuna responsabilità circa la tenuta dei supporti che dipendesse da insufficienza della parete a cui venissero applicati gli stessi poiché la verifica dell'idoneità della parete dovrà essere effettuata dal cliente.

## CONSISTENZA FINITURE

Le finiture potrebbero subire nel tempo modificazioni di colore dovute all'esposizione alla luce, al calore, ai vapori e all'invecchiamento. È, pertanto, naturale che in caso di successivi completamenti, si potranno avere delle differenze di tonalità che comunque dovrebbero tendere ad attenuarsi nel tempo. Per i piani in marmo e granito, considerando che il taglio proviene da BLOCCHI NATURALI, non possiamo garantire l'uniformità del colore e della grana. Questi fattori non potranno costituire motivo di contestazione o di resa del prodotto.

## TRASPORTO

La merce non viaggia mai con mezzi dell'AZIENDA e, di conseguenza, nel momento in cui questa viene affidata al vettore, a prescindere da chi lo abbia incaricato, o caricata nel mezzo del cliente tutti i rischi passano al cliente stesso. Il Cliente, anche tramite suoi incaricati, ha l'obbligo di controllare l'integrità della merce all'arrivo ed, eventualmente, fare le dovute contestazioni scritte al Vettore. Qualora il danno rende inutilizzabile la merce è opportuno non ritirarla dandone conto nel Documento di Trasporto, diversamente con l'apposizione della firma da parte del Cliente, senza alcuna contestazione e/o rilievo si attesta la perfetta integrità e conformità della merce.

## INSTALLAZIONE E IMPIEGO

L'AZIENDA declina ogni responsabilità per l'errata o impropria installazione del prodotto fornito (mobili, piani di lavoro, elettrodomestici, impianti elettrici o idraulici ecc.) siano essi di sua fabbricazione o di terzi, sempre che non provveda essa stessa alle predette operazioni. L'acquirente non potrà in nessun caso richiedere il risarcimento dei danni eventualmente causati in occasione dell'installazione. L'AZIENDA si ritiene esonerata da qualsiasi responsabilità circa il funzionamento degli elettrodomestici e degli accessori fabbricati da terzi costruttori, per i quali venga fornito dal predetto fabbricante lo specifico libretto di uso e manutenzione; nel libretto si troverà indicato l'eventuale Ufficio Reclami o i Centri di Assistenza del terzo fabbricante. Per l'impropria e/o inadeguata manutenzione, nonché per l'improprio e/o inadeguato utilizzo dei prodotti venduti, l'AZIENDA rinvia ogni e qualsiasi responsabilità e/o onere al Cliente o all'Utilizzatore.

## RECLAMI ED AZIONI

I vizi e i difetti devono essere denunciati all'AZIENDA nei termini di legge. Anche nel caso di contestazione i pagamenti non potranno essere sospesi.

La merce rimarrà di proprietà dell'AZIENDA sino al pagamento totale da parte del committente.

## GARANZIA

La garanzia sui prodotti venduti opererà per il tempo che, di volta in volta, le leggi vigenti nel Paese del Cliente stabiliranno come minimo a favore dell'acquirente.

## RESTITUZIONE DI MERCE

La restituzione delle merci vendute si accetta solo se espressamente autorizzata dalla LUBE INDUSTRIES s.r.l.. Verranno concordate modalità di reintegro e di accredito, solo qualora la restituzione sia dovuta a fatti imputabili alla LUBE INDUSTRIES s.r.l.. La merce restituita dovrà essere consegnata in perfette condizioni e adeguatamente imballata. La merce da sostituire dovrà essere restituita senza ritardo dal commerciante alla fabbricante. Nel caso in cui detta merce sia restituita fino a sei mesi dalla sostituzione la fabbricante accrediterà al commerciante il cento per cento del valore della stessa; tra i sei e i nove mesi sarà accreditato al commerciante il settanta per cento del valore della merce; qualora la restituzione avvenga tra i nove ed i dodici mesi dalla sostituzione sarà accreditato al commerciante il cinquanta per cento del valore della merce; qualora la restituzione non sia compiuta nei dodici mesi non vi sarà accreditato nessun valore della merce sostituita.

## SPESE

Per i pagamenti a mezzo tratte o ricevute bancarie verranno addebitati tutti gli oneri accessori alla riscossione.

## CONTROVERSIE

Per ogni controversia il Foro competente sarà esclusivamente quello di Macerata.

## EFFICACIA

Il Cliente, con il solo fatto di conferire l'ordinativo, si dichiara edotto ed accetta tutte le condizioni di vendita che precedono, salvo espresso patto contrario.

## MARCHIO

Il marchio  è un marchio commerciale registrato, la proprietà dei diritti di utilizzazione economica appartengono esclusivamente a l'AZIENDA o a terzi, pertanto è espressamente vietato l'utilizzo senza il preventivo consenso scritto del proprietario. L'utilizzo del marchio da parte dei clienti ai fini pubblicitari dovrà comunque essere preventivamente autorizzato dall'AZIENDA previa presa visione del materiale prima della pubblicazione. In ogni caso il logo non potrà subire alcuna modifica od alterazione nelle forme e nei colori ne potrà essere associato a prezzi o sconti promozionali.

# GENERAL SALES CONDITIONS

## VALIDITY

This price list replaces and annuls all previous versions.

It does not constitute an offer and may be subject to change following a written notification by COMPANY to the Customer, at any time and without prior notice.

Any modifications or updates shall apply to all orders received by or transmitted to COMPANY following the above-mentioned written notification.

## RETAIL PRICES AND PAYMENT TERMS

The retail prices quoted are exclusive of VAT and the WEEE fee and are ex works.

Upon expiry of the agreed payment term, COMPANY shall be authorised to issue bills of exchange for any outstanding amounts on every item, plus interest, expenses and any other additional liability, prior notification to the Customer. In the event of payment after the agreed term, accrued interest shall be charged in compliance with Italian Legislative Decree no. 231/2002, while any discounts expressly granted in relation to the payment terms shall be recovered.

If payment is not received within the agreed terms, COMPANY shall be entitled to suspend fulfilment of current orders, prior notification to the Customer.

## DELIVERY

The delivery term is calculated in working days and takes effect from the date on which the sales contract is stipulated. In any case, the contract is considered effective within 8 days from order transmission or, at all events, within 8 days from the most recent clarification (if requested) provided by the Customer. The delivery term shall be automatically extended should any events occur that are not imputable to COMPANY or that are due to force majeure. Partial deliveries can always be effected.

## THE PRODUCT

Any technical data relating to the products illustrated in this price list is purely indicative. The COMPANY reserves the right to effect any technical or structural modifications to improve the product, without prior notice. The goods may differ to some extent from the specifications given in the price list and the catalogue, or not be identical in all aspects to the samples viewed at the time of the order, since tolerances in relation to colours and tonalities are inevitable. Conformity with the samples is not obligatory. This right extends to household appliances or other kitchen furniture accessories; the appearance of the latter may differ slightly depending on the brand in question (which may differ from that shown in the catalogue), without prejudice to the basic conformity of features and functions. The Client may request specific components of a given brand from the range of products offered by the COMPANY, which is not liable in any way for the load bearing capacity of supports depending on the characteristics of the walls to which they are mounted; the Client alone is responsible for ensuring that the walls are able to support the load

## CONSISTENCY OF THE FINISHES

The finishes may be subject to slight changes in colour over time as a result of exposure to light, heat, vapours and ageing. Therefore, in the event of completion orders, there may be shade differences that will tend to diminish over time. Regarding marble and granite worktops, we cannot guarantee uniformity of colour and vein pattern as the worktops are cut from NATURAL BLOCKS. These factors may not provide grounds for claims or return of products.

## TRANSPORT

The goods never travel on vehicles owned by COMPANY; therefore, from the moment the goods are handed over to the forwarder and regardless of who entrusted the latter with the transport or loaded the goods into the customer's vehicle, all risks are transferred to the customer. The Customer - also through persons delegated by the latter - is obliged to check the integrity of the goods upon their arrival, and to notify written claims to the Forwarder. The Customer should not accept any damaged goods that are unsuitable for their intended use, and should notify the relevant claim on the transport document; otherwise, by signing the transport document without adding any claims and/or observations, the Customer certifies the integrity and conformity of the goods.

## INSTALLATION AND USE

The COMPANY is not liable for incorrect or improper installation of the supplied product (units, tops, household appliances, electrical and plumbing systems, etc.), whether manufactured by the company or by third parties, unless the COMPANY itself does the installation. The purchaser may not claim for any damages caused during installation. Moreover, the COMPANY is not liable for the operation of household appliances and accessories manufactured by third parties, for which user and maintenance manuals are provided by the manufacturer in question; the manuals include information regarding the Claims Office or Technical Assistance Centres of the third party manufacturer. As regards improper and/or inadequate maintenance, or any improper and/or inadequate use of the products sold, the COMPANY transfers all liability and/or resulting costs to the Client or User.

## CLAIMS

Any faults or defects must be reported to COMPANY within the terms specified by the law. Payment may not be suspended, even in the event of notification of claims.

The goods shall remain the property of COMPANY unless fully paid by customer.

## WARRANTY

Warranty on sold products in favour of the purchaser shall apply for the minimum duration specified case-by-case by the laws in force in the Customer's country.

## RETURN OF GOODS

Return of sold goods is only accepted if expressly authorised by LUBE INDUSTRIES s.r.l.. Replacement or reimbursement of said goods shall be mutually defined only if the goods return is due to events imputable to LUBE INDUSTRIES s.r.l.. The returned goods must be delivered in perfect conditions and suitably packaged.

The goods to be replaced must be returned from the retailer to the producer without delay. In the case that the goods are returned until six months after replacing the producer will credit the retailer 100% of the replaced goods value; between six and nine months after replacing, the producer will credit the retailer 70% of the replaced goods value; if the return is between nine and twelve months after the replacement, will be credited to the retailer 50% of the replaced goods value; if the refund is not made within twelve months will not be credited any of the replaced goods value.

## EXPENSES

For payments effected through bill of exchange or cash order, all additional collection expenses shall be charged.

## DISPUTES

The Court of Macerata shall have sole jurisdiction for any disputes that may arise.

## EFFECTIVENESS

For the sole fact of conferring the order, the Customer declares to be informed and accepts all the aforementioned sale conditions, unless otherwise expressly agreed on.

## BRAND

The trademark  is registered; the right of the commercial exploitation belongs only to the COMPANY or a third party, and the trademark may not be used without the owner's written consent. The client may only use the trademark for reasons of publicity if authorised in advance by COMPANY, following review of the material before publication. In any case, the logo may not be modified or altered in form or colour, nor may it be associated with promotional prices or discounts.

## INFORMAZIONI TECNICHE

### TECHNICAL INFORMATION

Le misure indicate nel presente listino sono espresse in cm.

Le profondità delle basi si intendono comprensive di top.

Le profondità dei pensili e delle colonne si intendono comprensive di ante.

Le altezze delle basi e delle colonne si intendono comprensive di zoccolo

Il verso degli elementi è individuato dalla posizione delle cerniere. Fanno eccezione solo l'angolo base e la colonna ad angolo dove il verso viene individuato dalla posizione dell'anta rispetto al mobile.

Per gli elementi con il verso, è stato inserito il codice con entrambi i versi (ad esempio una base da cm 45 cod. E4010451/2).

Sarà quindi necessario specificare se l'ultima cifra dovrà essere "1" per il verso destro cioè E4010451 oppure "2" per il verso sinistro cioè E4010452.

Per i lavelli il verso dx o sx è individuato dalla posizione delle vasche.

I prezzi indicati sono espressi all'unità di euro e sono IVA e contributo RAEE esclusi

I prezzi delle basi e delle colonne sono comprensivi dello zoccolo standard.

Per tutti i mobili fuori misura ha valore il listino riportato nella pagina maggiorazioni fuori misura.

Nel caso vengano richieste maniglie con passo diverso da quello previsto dal modello, le ante verranno fornite senza fori maniglia.

**I colori delle immagini riportate nel presente listino sono solamente indicativi e non possono essere utilizzati come riferimento.**

The measurements appearing in this price list are expressed in cm.

The depths of base units are inclusive of the worktop.

The depths of the wall units and columns are inclusive of the doors.

The heights of the base units and columns are inclusive of the plinth.

The direction of the elements is determined by the position of the hinges. The only exceptions are the corner base unit and corner column, where the direction is determined by the position of the door in relation to the cabinet.

For elements that come with a direction, the code includes both directions (e.g. 45 cm base unit - code E4010451/2).

It is therefore necessary to specify the last figure - "1" for the RH direction, i.e. E4010451, or "2" for the LH direction, i.e. E4010452.

The RH or LH direction of the sinks is determined by the position of the bowls.

The prices indicated are expressed in units of Euro and exclude VAT and the WEEE fee.

Prices of the base units and columns are inclusive of the standard plinth.

The prices that apply to all custom-sized cabinets are indicated on the page "Surcharges for custom-sized elements".

In the event of handles requested with a different centre-to-centre distance compared to the standard for the model, the doors will be supplied without pre-drilled holes for the handles.

**The colours in the pictures appearing in this price list are purely indicative and should not be used as reference.**

## COMPOSIZIONI SENZA ELETTRODOMESTICI E SENZA TOP

### COMPOSITIONS WITHOUT HOUSEHOLD APPLIANCES AND WORKTOP

**Tutte le composizioni richieste prive di elettrodomestici (frigo, forno, piano cottura, lavastoviglie o lavatrice), saranno aumentate di un importo netto pari a € 150 iva esclusa. Tale direttiva non si applica se la cucina contiene almeno due di questi elettrodomestici.**

**Tutte le composizioni richieste prive di top, saranno aumentate di un importo netto pari a € 100 iva esclusa.**

All compositions requested without household appliances (fridge, oven, cooker hob, dishwasher or washing machine) shall be subject to a price increase of € 150 VAT excluded.

This measure does not apply if the kitchen contains at least two of the above-mentioned appliances.

All compositions requested without worktop shall be subject to a price increase of € 100 VAT excluded.

# ELEMENTI FUORI MISURA

CUSTOM-SIZED ELEMENTS

<b>MODELLI</b> <small>MODELS</small>	<b>MODIFICABILE IN LARGHEZZA</b> <small>WIDTH ADJUSTABLE</small>	<b>MODIFICABILE IN ALTEZZA</b> <small>HEIGHT ADJUSTABLE</small>
<b>SMART NECK</b>	<b>SI</b> <b>MAX. 1 CM PER LATO</b> YES MAX. 1 CM FOR SIDE	<b>NO</b> NOT
<b>SMART BRIDGE</b>	<b>SI</b> <b>MAX. 1 CM PER LATO</b> YES MAX. 1 CM FOR SIDE	<b>NO</b> NOT

L'AZIENDA si riserva di accettare o meno la realizzazione di fuori misura di notevole difficoltà tecnica, previo invio di un disegno e successiva autorizzazione del ns. ufficio tecnico. Il prezzo di tali fuori misura sarà stabilito di volta in volta. Si intende che gli elementi fuori misura realizzati su Vs. richiesta, non saranno oggetto di ritiro.

COMPANY reserves the right to accept or decline processing of custom-sized elements that imply significant technical difficulties, subject to transmission of the drawing and subsequent authorisation by our Technical Dept. The price of these custom-sized elements shall be defined case-by-case. Any custom-sized elements manufactured on your request shall not be collected in the event of claims.

# MAGGIORAZIONI PER ELEMENTI FUORI MISURA

## SURCHARGES FOR CUSTOM-SIZED ELEMENTS

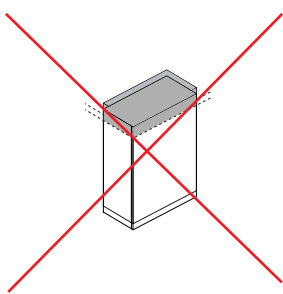
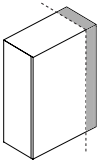
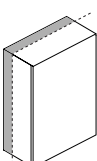
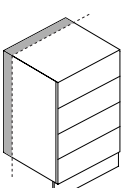
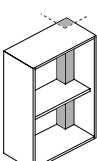
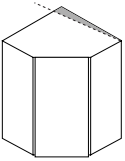
	DESCRIZIONE DESCRIPTION	MAGGIORAZIONE SURCHARGE		DESCRIZIONE DESCRIPTION	MAGGIORAZIONE SURCHARGE
	<p>Riduzioni in altezza non realizzabili</p> <p>The height cannot be reduction</p>			<p>Basi angolo fuori squadra</p> <p>Out-of-plumb corner base units</p>	
		<p><b>Basi</b> Base units NO</p> <p><b>Pensili</b> Wall units NO</p> <p><b>Colonne</b> Columns NO</p>			+ 28 %
	<p>Riduzioni in larghezza</p> <p>Width reduction</p>			<p>Basi e sottolavelli con portabombola</p> <p>Base and sink base units with cylinder holder</p>	
		<p><b>Basi</b> Base units + 28 %</p> <p><b>Pensili</b> Wall units + 28 %</p> <p><b>Colonne</b> Columns + 28 %</p>			+ 20 €
	<p>Riduzioni in profondità</p> <p>Depth reduction</p>			<p>Maggiorazioni per fianco scavato per inserimento piano cottura tra due basi (PPC opz. 011/012)</p> <p>Surcharge for digged side to insert cooking hob between two bases (PPC opt. 011/012)</p>	
		<p><b>Basi</b> Base units + 18 %</p> <p><b>Pensili</b> Wall units + 18 %</p> <p><b>Colonne</b> Columns + 18 %</p>			<p><b>Cadauno</b> each + 23 €</p>
	<p>Riduzioni per cassettera</p> <p><b>N.B.: modificabili solo in profondità fino a 31 cm al fianco</b></p> <p>Reductions for drawer unit</p> <p><b>Note: can only be modified depth-wise up to 31 cm on the side</b></p>			<p>Maggiorazioni per raggiatura mensola in laminato</p> <p>Surcharges for rounded edge on laminate shelf</p>	
		+ 18 %			<p><b>Codice</b> code <b>T9STP</b> + 38 €</p>
	<p>Taglio per pilastro</p> <p><b>N.B.: non realizzabile nei pensili con meccanismi</b></p> <p>Indent for pilaster</p> <p><b>Note: not feasible on wall units with mechanisms</b></p>			<p>Maggiorazione per inserimento tubo cappa (da sommare al prezzo del pensile)</p> <p>Surcharge for insertion of the hood pipe (to be added to the price of the wall unit)</p>	
		<p><b>Basi</b> Base units <b>Cod. T9SCB</b> + 90 €</p> <p><b>Pensili</b> Wall units <b>Cod. T9SCB</b> + 90 €</p> <p><b>Colonne</b> Columns <b>Cod. T9SCC</b> + 130 €</p>			+ 90 €
	<p>Pensili angolo fuori squadra</p> <p>Out-of-plumb corner wall units</p>			<p>Maggiorazione per inserimento cappa non standard</p> <p><b>N.B.: verificare sempre la fattibilità dell'incasso con il nostro ufficio tecnico</b></p> <p>Surcharge for the insertion of a non-standard hood</p> <p><b>Note: always verify the feasibility of the installation</b></p>	
		+ 28 %			+ 90 €

La maggiorazione è da applicare al prezzo dell'elemento di serie più grande rispetto a quello delle dimensioni richieste.

Negli elementi fuori misura per motivi di lavorazione, l'estetica può risultare inferiore agli elementi di serie.

The surcharge applies to the price of the standard element that is next largest to that of the requested size.

Due to the processing involved, the aesthetic level of custom-sized elements may be slightly inferior to that of standard elements.



**liscia** ○

a **telaiio**

**smooth or frame**



# smart

**18 MILLIMETRI:** È SU QUESTO SPESSORE CHE SI GIOCA LA SCELTA TRA LE ANTE A TELAIO PROPRIE DI SMART O LE LISCE DI TABLET E MIXARLE INSIEME. UNA SCELTA CHE DÀ UNA VALENZA NUOVA AL PROGETTO CUCINA CHE SI DEFINISCE SEMPRE PIÙ PERSONALIZZATO.

il piacere di mixare  
è **smart**

LE TANTISSIME FINITURE DISPONIBILI, SIA DI SMART SIA DI TABLET DA MIXARE A LORO VOLTA, OFFRONO LA POSSIBILITÀ DI **CREARE UN MODELLO UNICO**, FATTO SU MISURA PER LE ESIGENZE E SECONDO I GUSTI DI OGNUNO. PIÙ SMART DI COSÌ!

## TAB LET.

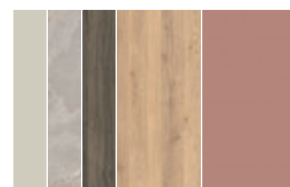

The pleasure of mixing is **smart**

**18 Millimeters:** it is on this thickness that **the choice is made between the framed doors featured in smart or the smooth ones characterizing tablet, as well as the possibility to mix them together.** A choice that gives a new value to the kitchen project, making it more and more personalized.

**The large range of finishes available, both in smart and in tablet, to be mixed in turn, offer the possibility to create a unique model,** customized according to one's own needs and tastes. It couldn't be any smarter!



# smart

Facile, adattabile, essenziale, in una parola Smart. È la nuova cucina Creo Kitchens le cui ante e finiture possono essere mixate con quelle di Tablet sia in versione Bridge che Neck. Smart nasce con le ante a telaio spessore 18 mm, lo stesso delle ante lisce di Tablet. Le innumerevoli finiture disponibili dell'uno e dell'altro modello possono essere intercambiabili. Ecco perchè si può sviluppare un progetto unico, creando un'alternanza di ante e di finiture ogni volta diverso, con accostamenti inediti e ricchezza di soluzioni funzionali capaci di integrarsi perfettamente tra loro.

Smart è una cucina in continua evoluzione e si identifica con lo stile di chi la sceglie e a cui piace l'idea di poter mixare, abbinare, alternare, reinterpretare, rivisitare. Diventa molto Smart, intelligente e divertente definire uno spazio cucina costruito su misura delle proprie esigenze e dei propri gusti! E questo grazie alla flessibilità progettuale di Creo Kitchens sempre più orientata alla massima personalizzazione dei prodotti e alla realizzazione di soluzioni originali.





### CREO ECOLOGIC

IL GRUPPO LUBE HA SCELTO DI UTILIZZARE PER I COMPONENTI COSTITUENTI LE STRUTTURE DELLE CUCINE SOLO MATERIALE A BASSISSIMA EMISSIONE DI FORMALDEIDE: CONFORMI ALLO STANDARD F4STELLE SECONDO LA NORMA JIS, CERTIFICATO DAL MINISTERO GIAPPONESE, IL PIU' SEVERO IN MERITO ALLE NORMATIVE DI SALVAGUARDIA AMBIENTALE.

Regarding the production of its kitchen structure components, lube group has decided to only use materials featuring very low formaldehyde emissions complying with the 4-star standard, as defined by the jis regulation. This standard is certified by the japanese government-the most rigorous when it comes to environmental protection.

Easy, adaptable, pared-back - in a word, Smart. This is the new Creo Kitchens project with doors and finishes that can be combined with the Tablet ones, both in the Bridge and Neck version.

Smart has framed cabinetry which is 18-mm thick, the same as Tablet's frameless cabinetry.

The countless finishes available for both styles are interchangeable.

This is why it is so easy to put together a unique project, alternating doors and finishes to create a different look each time with a series of unusual combinations and a wealth of functional solutions that seamlessly integrate with each other.

Ever-evolving, Smart is a kitchen that reflects the taste of the home-owners and lends itself to mixing, matching, changing up, re-imagining and reworking. Defining a kitchen space which is tailored not only to your needs, but also to your individual tastes is a very fun, sensible and Smart thing to do! And now you can, thanks to the design flexibility offered by Creo Kitchens which is increasingly geared to full product customisation and to coming up with original solutions.



## CARATTERISTICHE TECNICHE

<b>ANTE E FRONTALI CASSETTI</b>	<p>anta sp. 18 mm a telaio in MDF certificato (conforme <b>US EPA TSCA Title VI</b>) rivestita in alkorcell effetto legno nei colori: frassino bianco alpino (opz.2310), rovere greige (opz.2320), betulla (opz.2311)</p> <p>anta sp. 18 mm a telaio in MDF certificato (conforme <b>US EPA TSCA Title VI</b>) rivestita in PET opaco tinta unita nei colori: gesso supermatt (opz.7464), sahara supermatt (opz.7717), luna supermatt (opz.9610), carbone supermatt (opz.9613)</p>
<b>ANTE VETRO</b>	<p>anta sp. 18 a telaio in MDF certificato (conforme <b>US EPA TSCA Title VI</b>), rivestita in alkorcell effetto metallo spazzolato, vetro extrachiaro temperato 4 mm filo grezzo serigrafato trama tessuto in vernice satinata nei colori: metal lux (opz.2300), metal dark (opz.2309)</p> <p>anta sp. 18 a telaio in MDF certificato (conforme <b>US EPA TSCA Title VI</b>), rivestita in PET opaco tinta unita, vetro extrachiaro temperato 4 mm filo grezzo serigrafato trama tessuto in vernice satinata nei colori: gesso supermatt (opz.7464), sahara supermatt (opz.7717), luna supermatt (opz.9610), carbone supermatt (opz.9613)</p>
<b>MANIGLIE</b>	<p><a href="#">vedi pag.20</a></p>
<b>STRUTTURE DI SERIE</b>	<p><b>ANTE: FRASSINO BIANCO ALPINO, GESSO SUPERMATT</b> nobilitato bianco (opz.001), schiena e ripiano bianco (opz.001)</p> <p><b>ANTA: SAHARA SUPERMATT</b> nobilitato conchiglia (opz.8910) schiena e ripiano conchiglia (opz.8910)</p> <p><b>ANTA: CARBONE SUPERMATT</b> nobilitato lavagna (opz.9620) schiena e ripiano lavagna (opz.9620)</p> <p><b>ANTE: ROVERE GREIGE, BETULLA</b> nobilitato visone (opz.948M) schiena e ripiano visone (opz.948M)</p> <p><b>ANTA: LUNA SUPERMATT</b> nobilitato argilla (opz.9690) schiena e ripiano argilla (opz.9690)</p> <p>a richiesta: nobilitato fango (opz.8860) schiena e ripiano fango (opz.8860)</p>
<b>STRUTTURE CONSIGLATE</b>	<p><b>PER ANTE VETRO FINITURA ALKORCELL</b></p> <p><b>ANTA VETRO: METAL LUX</b> nobilitato visone (opz.948M) schiena e ripiano visone (opz.948M)</p> <p><b>ANTA VETRO: METAL DARK</b> nobilitato lavagna (opz.9620) schiena e ripiano lavagna (opz.9620)</p>
<b>MENSOLE</b>	<p>di serie: altezza 3,8 cm in laminato bianco (opz.001), conchiglia (opz.8910), fango (opz.8860), lavagna (opz.9620), visone (opz.948M), argilla (opz.9690)</p> <p>a richiesta: altezza 3,8 cm finiture come ante</p>
<b>ZOCCOLI</b>	<p><a href="#">vedi pag.22</a></p>



Note: the prices are expressed in units of euro (vat excluded)

## TECHNICAL SPECIFICATIONS

DOORS AND DRAWER FRONT PANELS	<p>18-mm thick certified framed MDF door panel (compliant with <a href="#">US EPA TSCA Title VI</a>) coated with wood-effect alkorcell in the following shades: alpine-white ash (opz.2310), greige oak (opz.2320), birch (opz.2311)</p> <p>18-mm thick certified framed MDF door panel (compliant with <a href="#">US EPA TSCA Title VI</a>), coated with plain matt PET in the following shades: super-matt gypsum (opz.7464), super-matt sahara (opz.7717), super-matt moon (opz.9610), super-matt carbon (opz.9613)</p>
GLASS DOORS	<p>18-mm thick certified framed MDF door panel (compliant with <a href="#">US EPA TSCA Title VI</a>), coated with brushed metal-effect alkorcell, extra-clear tempered glass, 4 mm, ground edges, screen-printed fabric pattern with satin-finish paint in the following shades: metal lux (opz.2300), dark metal (opz.2309)</p> <p>18-mm thick certified framed MDF door panel (compliant with <a href="#">US EPA TSCA Title VI</a>), coated with plain matt PET, extra-clear tempered glass, 4 mm, ground edges, screen-printed fabric pattern with satin-finish paint in the following shades: super-matt gypsum (opz.7464), super-matt sahara (opz.7717), super-matt moon (opz.9610), super-matt carbon (opz.9613)</p>
HANDLES	<p><a href="#">see page 20</a></p>
STANDARD STRUCTURES	<p><b>DOORS: ALPINE-WHITE ASH, SUPER-MATT GYPSUM</b> melamine-faced white (opz.001), white back panel and shelf (opz.001)</p> <p><b>DOOR: SUPER-MATT SAHARA</b> melamine-faced seashell (opz.8910), seashell back panel and shelf (opz.8910)</p> <p><b>DOOR: SUPER-MATT CARBON</b> melamine-faced slate grey (opz.9620), slate-grey back panel and shelf (opz.9620)</p> <p><b>DOORS: GREIGE OAK, BIRCH</b> melamine-faced mink (opz.948M), mink back panel and shelf (opz.948M)</p> <p><b>DOOR: SUPER-MATT MOON</b> melamine-faced clay (opz.9690), clay back panel and shelf (opz.9690)</p> <p>on request: melamine-faced mud (opz.8860), mud back panel and shelf (opz.8860)</p>
RECOMMENDED STRUCTURES	<p><b>FOR GLASS DOORS WITH ALKORCELL FINISH</b></p> <p><b>GLASS DOOR: LUX METAL</b> melamine-faced mink (opz.948M), mink back panel and shelf (opz.948M)</p> <p><b>GLASS DOOR: DARK METAL</b> melamine-faced slate grey (opz.9620), slate-grey back panel and shelf (opz.9620)</p>
SHELVES	<p>standard: 3.8 cm thick, laminate, white (opz.001), seashell (opz.8910), mud (opz.8860), slate grey (opz.9620), mink (opz.948M), clay (opt.9690)</p> <p>on request: 3.8 cm thick, with the same finish as doors</p>
PLINTHS	<p><a href="#">see page 22</a></p>

# smart

Neck cod. **KS2**

Bridge cod. **KS1**

ante finitura alkorcell effetto legno  
alkorcell wood effect finish doors

 *colori in pronta consegna  
available colours*



frassino bianco alpino (opz.2310)  
alpine-white ash (opt.2310)



rovere greige (opz.2320)  
greige oak (opt.2320)



betulla (opz.2311)  
birch (opt.2311)

**N.B.: disponibile a partire da Giugno 2021**  
Note: available from June 2021

**SP. 18 MM TH.18 MM**

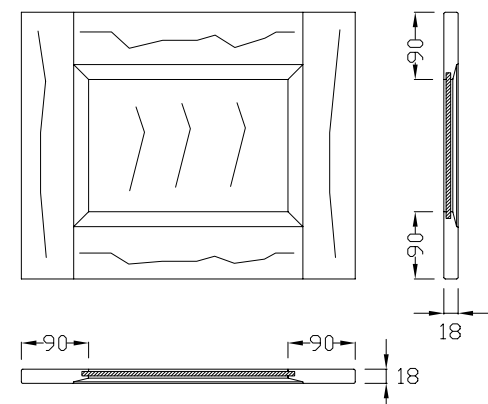

# smart

Neck cod. **KS2**

Bridge cod. **KS1**

ante finitura PET opaco tinta unita  
solid color matt PET finish doors

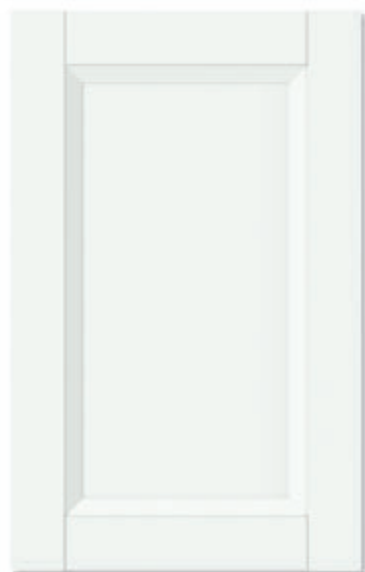

gesso supermatt (opz.7464)  
super-matt gypsum (opt.7464)

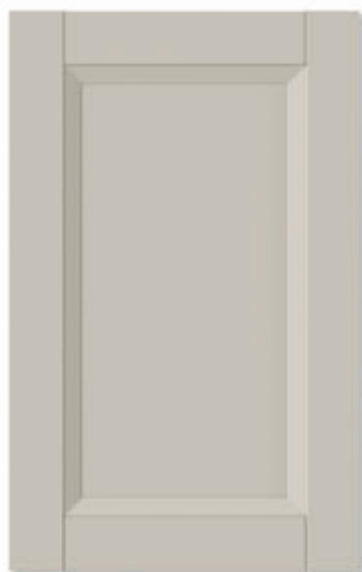

sahara supermatt (opz.7717)  
super-matt sahara (opt.7717)

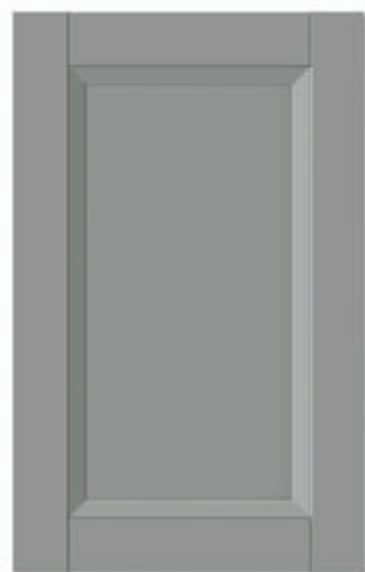

luna supermatt (opz.9610)  
super-matt moon (opt.9610)



carbone supermatt (opz.9613)  
super-matt carbon (opt.9613)

SP. 18 MM TH.18 MM

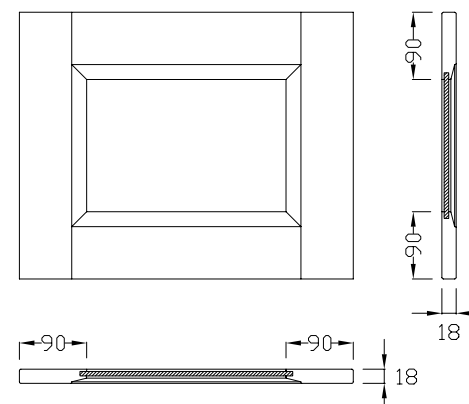

# smart

Neck cod. **KS2**  
Bridge cod. **KS1**

ante vetro finitura alkorcell effetto metallo spazzolato  
glass doors alkorcell brushed metal effect finish

 *colori in pronta consegna  
available colours*



metal lux (opz.2300)  
finitura spazzolata con vetro  
extrachiaro serigrafato, trama  
tessuto in vernice satinata  
metal lux (opt.2300)  
brushed finish with extra-clear  
screen-printed glass, fabric  
pattern in satin-finish paint



metal dark (opz.2309)  
finitura spazzolata con vetro  
extrachiaro serigrafato, trama  
tessuto in vernice satinata  
dark metal (opt.2309)  
brushed finish with extra-clear  
screen-printed glass, fabric  
pattern in satin-finish paint

SP. 18 MM TH.18 MM

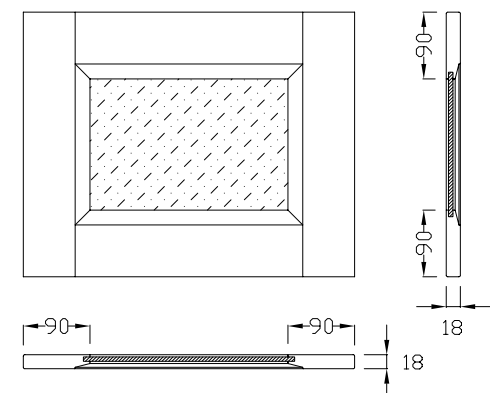

ante vetro finitura PET  
glass doors PET finish



gesso supermatt (opz.7464)  
vetro extrachiaro serigrafato,  
trama tessuto in vernice satinata  
super-matt gypsum (opz.7464)  
extra-clear screen-printed glass,  
fabric pattern in satin-finish paint



sahara supermatt (opz.7717)  
vetro extrachiaro serigrafato,  
trama tessuto in vernice satinata  
super-matt sahara (opz.7717)  
extra-clear screen-printed glass,  
fabric pattern in satin-finish paint

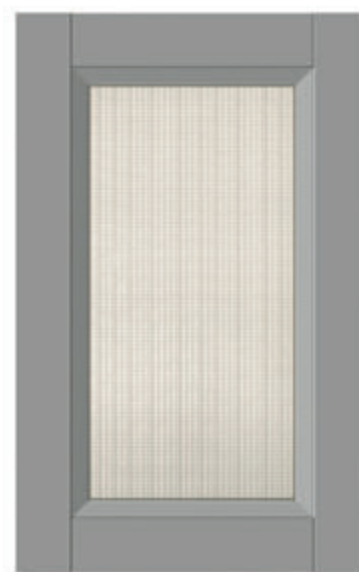

luna supermatt (opz.9610)  
vetro extrachiaro serigrafato,  
trama tessuto in vernice satinata  
super-matt moon (opz.9610)  
extra-clear screen-printed glass,  
fabric pattern in satin-finish paint

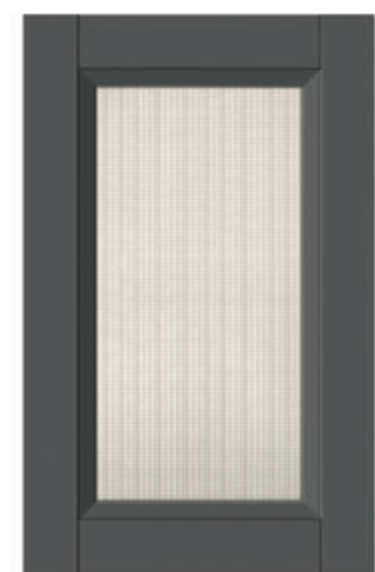

carbone supermatt (opz.9613)  
vetro extrachiaro serigrafato,  
trama tessuto in vernice satinata  
super-matt carbon (opz.9613)  
extra-clear screen-printed glass,  
fabric pattern in satin-finish paint

# Neck

## FINITURE GOLE

FINITURE GOLE SPAZZOLATE  
FINGER RAILS BRUSHED FINISHES

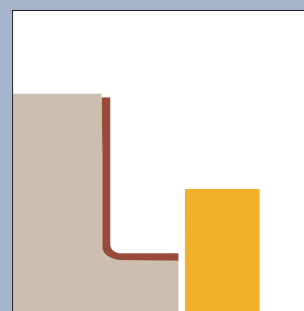
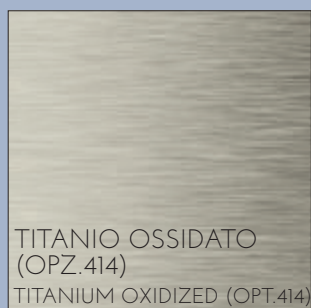
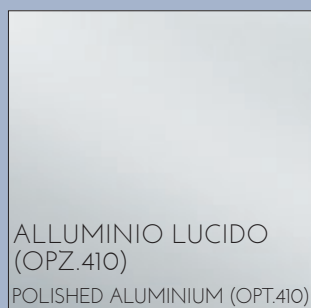

GOLA TIPO "ELLE"  
"ELLE" TYPE FINGER RAIL



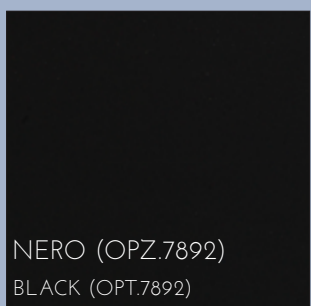
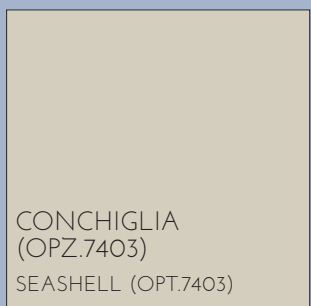
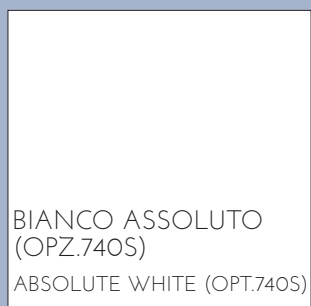

FINITURE GOLE VERNICIATE A POLVERE OPACHE  
MATT FINGER RAILS POWDER COATED FINISHES





# GOLA "ELLE" ORIZZONTALE SOTTOTOP

UNDERMOUNT HORIZONTAL "ELLE" FINGER RAIL

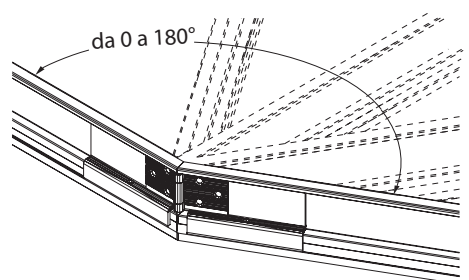
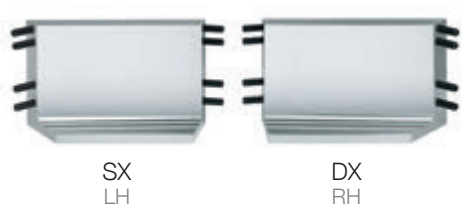



	COD.	€		COD.	€	
<p><b>Gola sottotop tipo "A"</b>  <b>N.B.: costo gola già compreso nel prezzo delle basi</b>                      Type "A" undermount finger rail                      Note: finger rail cost already included in base unit price</p>  <p style="text-align: right;"><b>al ml</b> per lm</p>	G950010	23	<p><b>Angolo interno a 90° per gola tipo "A"</b>  <b>N.B.: costo angolare già compreso nel prezzo delle basi angolo</b>                      90° interior corner for "A" type finger rail                      Note: corner piece cost already included in corner unit price</p>  <p style="text-align: right;"><b>cadauno</b> each</p>	G950050	48	
<p><b>Terminale aperto dx o sx per gola tipo "A" da utilizzare a fine composizione</b>                      RH or LH open end for type "A" finger rail to be placed at the end of the composition</p>  <p style="text-align: right;"><b>in alluminio</b> aluminium</p> <p style="text-align: right;"><b>terminale DX</b> RH end</p> <p style="text-align: right;"><b>terminale SX</b> LH end</p> <p style="text-align: right;"><b>in plastica (solo finitura opz.410)</b> plastic (only finish opt.410)</p> <p style="text-align: right;"><b>terminale DX</b> RH end</p> <p style="text-align: right;"><b>terminale SX</b> LH end</p>	G950021	23	<p><b>Angolare con snodo per unione fuori squadra per gola tipo "A"</b>                      Corner piece with joint for out-of-plumb joining for type "A" finger rail</p> 	G950022	23	
	G950041	8			G950042	8
	G950031	23		<p><b>Angolare con snodo per unione fuori squadra per gola tipo "A"</b>                      Corner piece with joint for out-of-plumb joining for type "A" finger rail</p> 	G950032	23
	G950045	8				G950046
	G950060	57				
<p><b>Coppia angolari per kit raccordo base angolo 110x110</b>                      Couple corner piece for fitting kit corner base unit 110x110</p>  <p style="text-align: right;"><b>in alluminio</b> aluminium</p> <p style="text-align: right;"><b>angolare DX</b> RH corner piece</p> <p style="text-align: right;"><b>angolare SX</b> LH corner piece</p>	G950058	102			G950059	102

## GOLA "ELLE" ORIZZONTALE INTERMEDIA

INTERMEDIATE HORIZONTAL "ELLE" FINGER RAIL

## GOLE "ELLE" VERTICALI PER COLONNE

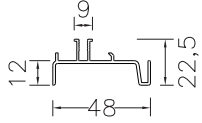
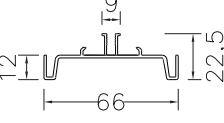
VERTICAL "ELLE" FINGER RAILS FOR COLUMNS

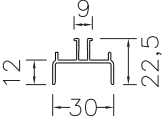
	COD.	€		COD.	€	
 <p><b>Gola intermedia tipo "B"</b>  <b>N.B.: costo gola già compreso nel prezzo delle basi con cassetti o cestoni</b>                      Type "B" intermediate finger rail                      Note: finger rail cost already included in price base unit with drawers or deep drawers</p>			 <p><b>Mezza gola verticale tipo "C" (completa di distanziale)</b>                      Type "C" half vertical finger rail (complete with spacer)</p>  <p>sezione mezza gola tipo "C"                      cross section of type "C" finger rail</p>			
	al ml per lm	G950110		33	<p><b>sezione gola tipo "D"</b>                      cross section of type "D" finger rail</p> 	
 <p><b>Terminale aperto dx o sx per gola tipo "B" da utilizzare a fine composizione</b>                      RH or LH open end for type "B" finger rail to be placed at the end of the composition</p>			<p><b>Gola verticale intermedia tipo "D" (completa di distanziale)</b>                      Type "D" intermediate vertical finger rail (complete with spacer)</p>			
	in alluminio aluminium					
	<b>terminale DX</b> RH end	G950121		28		
	<b>terminale SX</b> LH end	G950122		28		
	in plastica (solo finitura opz.410) plastic (only finish opt.410)					
	<b>terminale DX</b> RH end	G950141		8		
	<b>terminale SX</b> LH end	G950142		8		
 <p><b>Terminale chiuso dx o sx per gola tipo "B" da utilizzare solo tra cassettiere e lavastoviglie/colonne</b>                      RH or LH closure for type "B" finger rail to be placed only between drawer units and dishwasher/columns</p>			<p><b>Gola verticale laterale tipo "E" (completa di distanziale)</b>                      Type "E" lateral vertical finger rail (complete with spacer)</p>  <p>sezione gola tipo "E"                      cross section of type "E" finger rail</p>			
	in alluminio aluminium					
	<b>terminale DX</b> RH end	G950131		28		
	<b>terminale SX</b> LH end	G950132		28		
	in plastica (solo finitura opz.410) plastic (only finish opt.410)					
	<b>terminale DX</b> RH end	G950145		8		
	<b>terminale SX</b> LH end	G950146		8		

# NOZIONI UTILI - gole "elle" orizzontali per basi

USEFUL INFORMATION - HORIZONTAL "ELLE" FINGER RAILS FOR BASE UNITS

## VISTA FRONTALE ZOCCOLO H 13 PER BASI H 88

FRONT VIEW PLINTH H 13 FOR BASE UNITS H 88

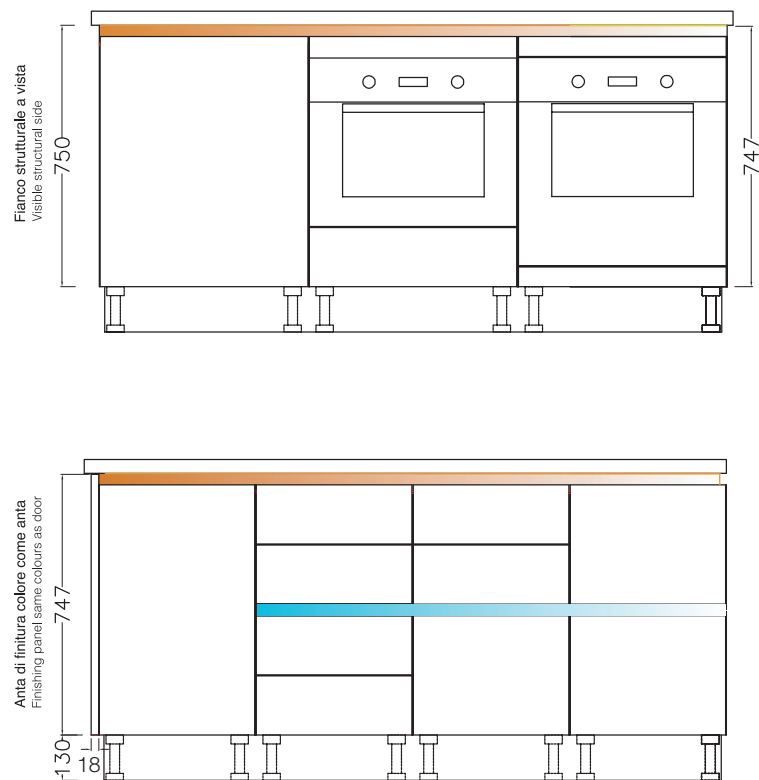

## VISTA LATERALE (sezione) ZOCCOLO H 13 PER BASI H 88

SIDE VIEW (CROSS SECTION) PLINTH H 13 FOR BASE UNITS H 88

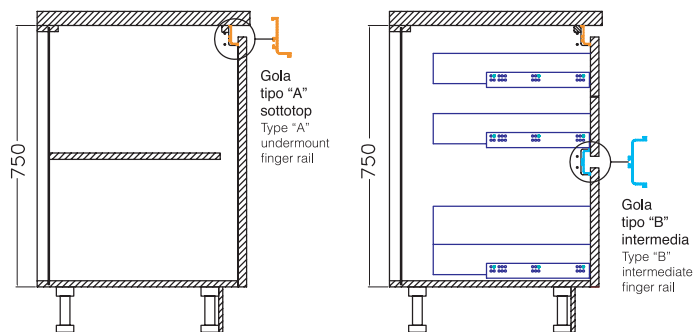

## VISTA DALL'ALTO

TOP VIEW



Composizione con ante di finitura laterali: alla dimensione finale della cucina, sommare sempre lo spessore delle ante di finitura (ogni anta 18 mm)

Composition with side finishing panels: to the final size of the kitchen, always add the thickness of the finishing panels (each panel 18 mm)

# NOZIONI UTILI - gole "elle" verticali per colonne

USEFUL INFORMATION - VERTICAL "ELLE" FINGER RAILS FOR COLUMNS

## VISTA FRONTALE ZOCCOLO H 13

FRONT VIEW PLINTH H 13

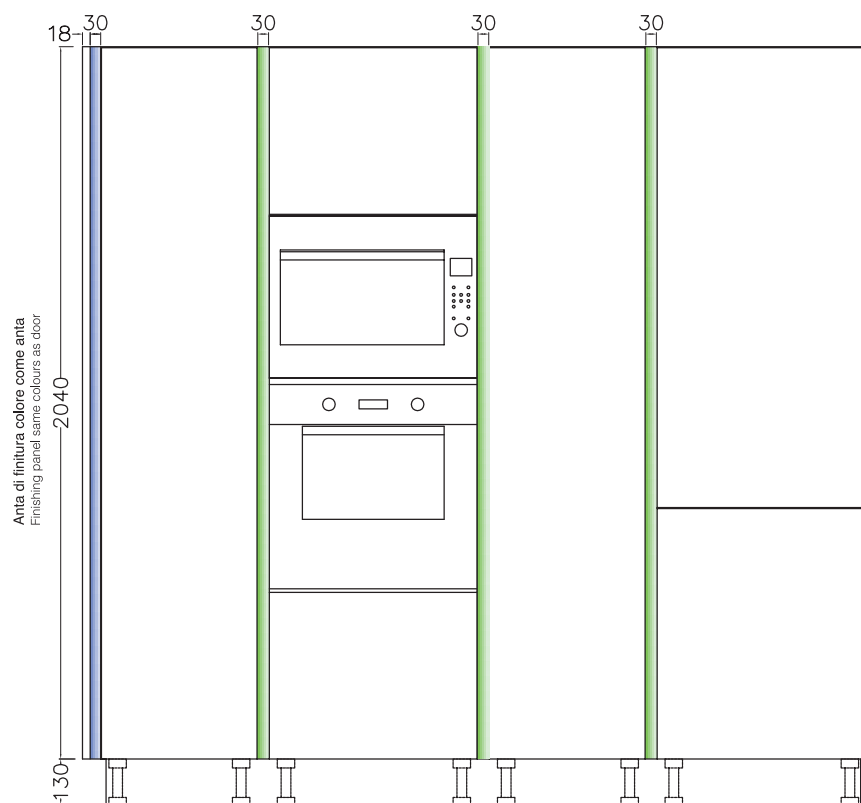

## VISTA DALL'ALTO

TOP VIEW

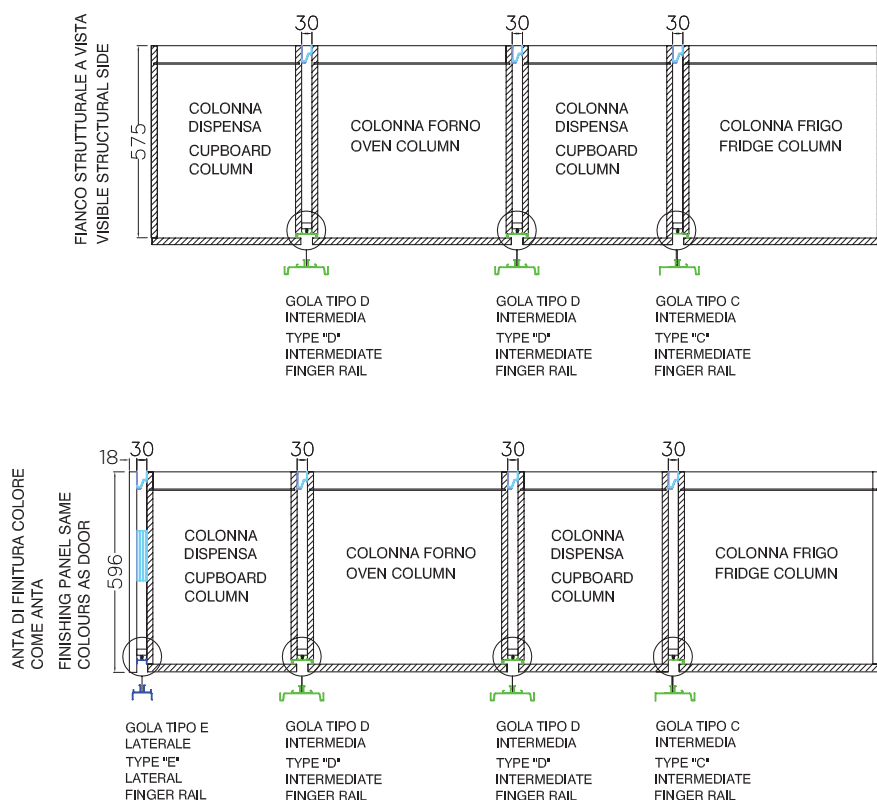

Composizione fianco strutturale a vista come anta: alla dimensione finale della cucina, sommare sempre lo spessore dei distanziali tra le colonne (ogni distanziale 3 cm)

Composition with visible side panel to match door: to the final size of the kitchen, always add the thickness of the spacers between the two columns (each spacer 3 cm)

Composizione con ante di finitura laterali, alla dimensione finale della cucina, sommare sempre lo spessore dei distanziali tra le colonne (ogni distanziale 3 cm) e lo spessore delle ante di finitura (ogni anta 18 mm)

Composition with side finishing panels to the final size of the kitchen, always add the thickness of the spacer between the two columns (each spacer 3 mm) and the thickness of the finishing panels (each panel 18 mm)

### DI SERIE STANDARD



Maniglia K92 finitura grigio selce  
 anta da L 15 a L 30 → passo 64 mm  
 anta da L 40 a L 65 → passo 160 mm  
 anta da L 75 a L 120 → passo 320 mm

Handle K92 flint grey finish  
 door from W 15 to W 30 → centre-to-centre distance 64 mm  
 door from W 40 to W 65 → centre-to-centre distance 160 mm  
 door from W 75 to W 120 → centre-to-centre distance 320 mm

### A RICHIESTA ON REQUEST



Maniglia K93 finitura ghisa  
 anta da L 15 a L 30 → passo 64 mm  
 anta da L 40 a L 65 → passo 160 mm  
 anta da L 75 a L 120 → passo 320 mm

Handle K93 caston iron finish  
 door from W 15 to W 30 → centre-to-centre distance 64 mm  
 door from W 40 to W 65 → centre-to-centre distance 160 mm  
 door from W 75 to W 120 → centre-to-centre distance 320 mm



Maniglia K94 finitura silver dark  
 anta da L 15 a L 30 → pomo  
 anta da L 40 a L 65 → passo 160 mm  
 anta da L 75 a L 120 → passo 320 mm

Handle K94 dark silver finish  
 door from W 15 to W 30 → knob  
 door from W 40 to W 65 → centre-to-centre distance 160 mm  
 door from W 75 to W 120 → centre-to-centre distance 320 mm



Maniglia K85 finitura cromo satinato  
 anta da L 15 a L 30 → passo 96 mm  
 anta da L 40 a L 65 → passo 160 mm  
 anta da L 75 a L 120 → passo 320 mm

Handle K85 satin chrome finish  
 door from W 15 to W 30 → centre-to-centre distance 96 mm  
 door from W 40 to W 65 → centre-to-centre distance 160 mm  
 door from W 75 to W 120 → centre-to-centre distance 320 mm



Maniglia K87 finitura nichel lux  
 anta da L 15 a L 30 → passo 96 mm  
 anta da L 40 a L 65 → passo 160 mm  
 anta da L 75 a L 120 → passo 320 mm

Handle K87 lux nikel finish  
 door from W 15 to W 30 → centre-to-centre distance 96 mm  
 door from W 40 to W 65 → centre-to-centre distance 160 mm  
 door from W 75 to W 120 → centre-to-centre distance 320 mm



Maniglia K90 finitura bronzo  
 anta da L 15 a L 30 → passo 64 mm  
 anta da L 40 a L 120 → passo 160 mm

Handle K90 bronze finish  
 door from W 15 to W 30 → centre-to-centre distance 64 mm  
 door from W 40 to W 120 → centre-to-centre distance 160 mm



MANIGLIE  
HANDLES

# smart

## strutture carcasses



bianco (opz.001)  
schiena e ripiano bianco  
(opz.001)  
white (opt.001)  
white back panel and shelf  
(opt.001)



conchiglia (opz.8910)  
schiena e ripiano conchiglia  
(opz.8910)  
shell (opt.8910)  
shell back panel and shelf  
(opt.8910)



visone (opz.948M)  
schiena e ripiano visone  
(opz.948M)  
mink (opt.948M)  
mink back panel and shelf  
(opt.948M)



fango (opz.8860)  
schiena e ripiano fango  
(opz.8860)  
mud (opt.8860)  
mud back panel and shelf  
(opt.8860)



lavagna (opz.9620)  
schiena e ripiano lavagna  
(opz.9620)  
slate grey (opt.9620)  
slate grey back panel and shelf  
(opt.9620)



argilla (opz.9690)  
schiena e ripiano argilla  
(opz.9690)  
clay (opt.9690)  
clay back panel and shelf  
(opt.9690)



Il Gruppo LUBE è stata la prima azienda in Italia ad ottenere per le strutture delle sue cucine la Certificazione GREENGUARD Gold, che è garanzia della bassissima emissione di sostanze chimiche inquinanti COV.

Gruppo Lube was the first company in Italy achieving the GREENGUARD Gold Certification for its kitchen structures, which is a guarantee of the very low VOC polluting chemicals emission.



### CREO ECOLOGIC

IL GRUPPO LUBE HA SCELTO DI UTILIZZARE PER I COMPONENTI COSTITUENTI LE STRUTTURE DELLE CUCINE SOLO MATERIALE A BASSISSIMA EMISSIONE DI FORMALDEIDE: CONFORMI ALLO STANDARD F\*\*\*\* SECONDO LA NORMA JIS, CERTIFICATO DAL MINISTERO GIAPPONESE, IL PIU' SEVERO IN MERITO ALLE NORMATIVE DI SALVAGUARDIA AMBIENTALE.

LUBE GROUP HAS CHOSEN TO EXCLUSIVELY USE MATERIALS WITH VERY LOW FORMALDEHYDE EMISSIONS FOR THE COMPONENTS MAKING UP THE KITCHEN CARCASSES: THESE ELEMENTS COMPLY WITH THE F4 STAR STANDARD ACCORDING TO JIS, CERTIFIED BY THE JAPANESE GOVERNMENT - THE MOST STRINGENT WHEN IT COMES TO ENVIRONMENTAL PROTECTION.

## zoccoli in pvc H 13 pvc plinths H 13

di serie  
standard



acciaio (opz.407)  
steel (opt.407)



alluminio satinato  
(opz.405)  
satin aluminium  
(opt.405)



bianco (opz.001)  
white (opt.001)

## zoccoli in alluminio H 13 aluminium plinths H 13

magg. rispetto allo zoccolo standard  
surcharges compared to standard plinth



alluminio liscio finitura  
brill (opz.412)  
smooth aluminium with  
brill finish (opt.412)



alluminio finitura titanio  
ossidato (opz.414)  
aluminium titanium  
oxidized finish (opt.414)

al ml  
per lm                      cod.092125                      +20€  
code

angolare  
corner                      cod.0923933                      +2€  
code

# smart

zoccoli in alluminio H 13 verniciati a polvere finitura opaca  
aluminum plinths H 13 powder coated matt finish



alluminio finitura bianco assoluto (opz.740S)  
aluminium absolute white finish (opt.740S)



alluminio finitura grigio selce (opz.SE)  
aluminium flint grey finish (opt.SE)



alluminio finitura silver dark (opz.9507)  
aluminium dark silver finish (opt.9507)



alluminio finitura ghisa (opz.9509)  
aluminium cast iron finish (opt.9509)

magg. rispetto allo zoccolo standard  
surcharges compared to standard plinth

al ml  
per lm

cod.092125  
code

**+35 €**

angolare  
corner

cod.0923933  
code

**+4 €**

mensole in laminato laminate shelves



bianco (opz.001)  
white (opt.001)



conchiglia (opz.8910)  
shell (opt.8910)

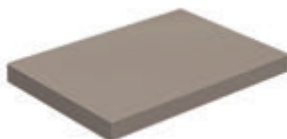

visone (opz.948M)  
mink (opt.948M)



lavagna (opz.9620)  
slate grey (opt.9620)

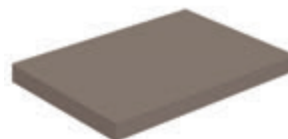

fango (opz.8860)  
mud (opt.8860)

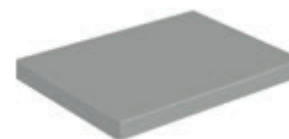

argilla (opz.9690)  
clay (opt.9690)

mensole in alkorcell colore come ante alkorcell shelves same colour as doors

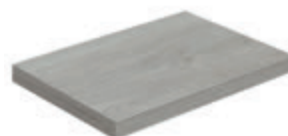

colori come ante (vedi pag.12)  
colours same as doors (see page 12)

mensole in PET colore come ante PET shelves same colour as doors

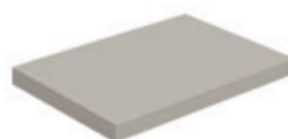

colori come ante (vedi pag.13)  
colours same as doors (see page 13)





# MODULARITÀ E COMPONENTIBILITÀ MODULARITY AND FITTING SOLUTIONS

## BASI H 76

BASE UNITS H 76

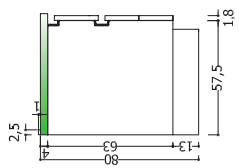

## BASI LIVING CON ZOCCOLO

ROOM UNITS WITH PLINTH

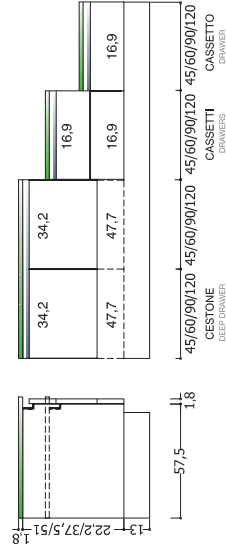

## BASI LIVING CON PIEDINO CROMATO H 2

ROOM UNITS WITH CHROME FEET H 2

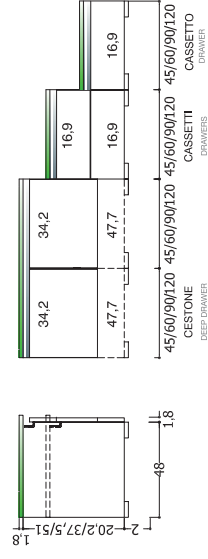

## COLONNE FRIGO

FRIDGE COLUMNS

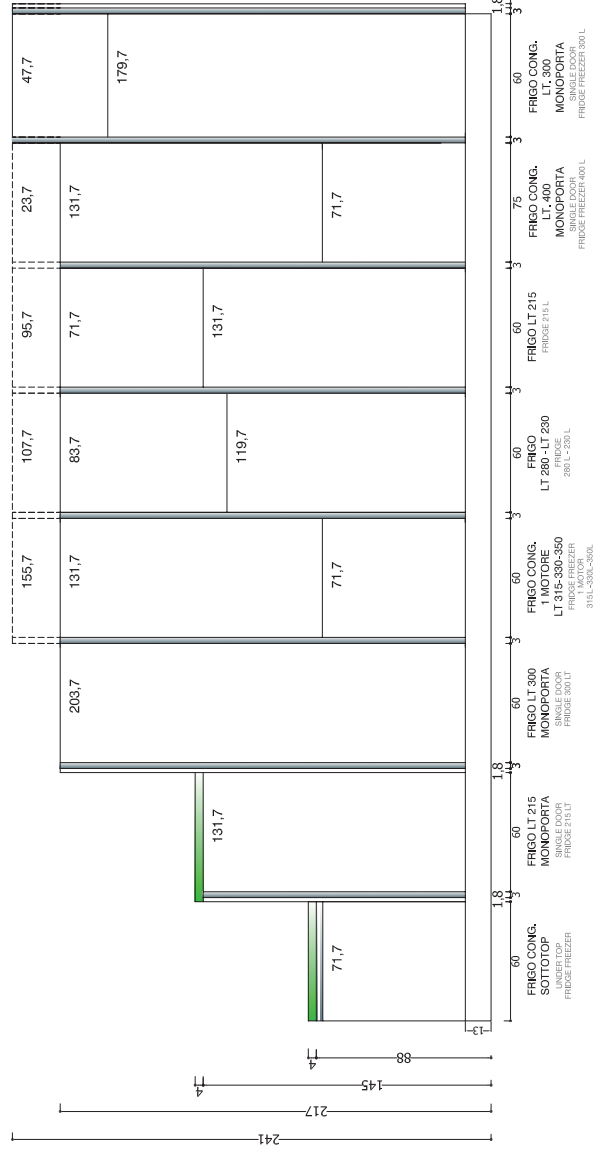
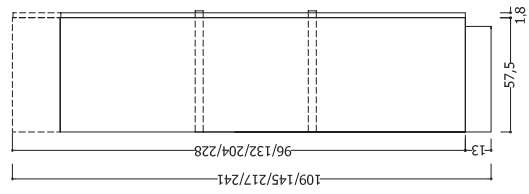

## COLONNE FORNO

OVEN COLUMNS

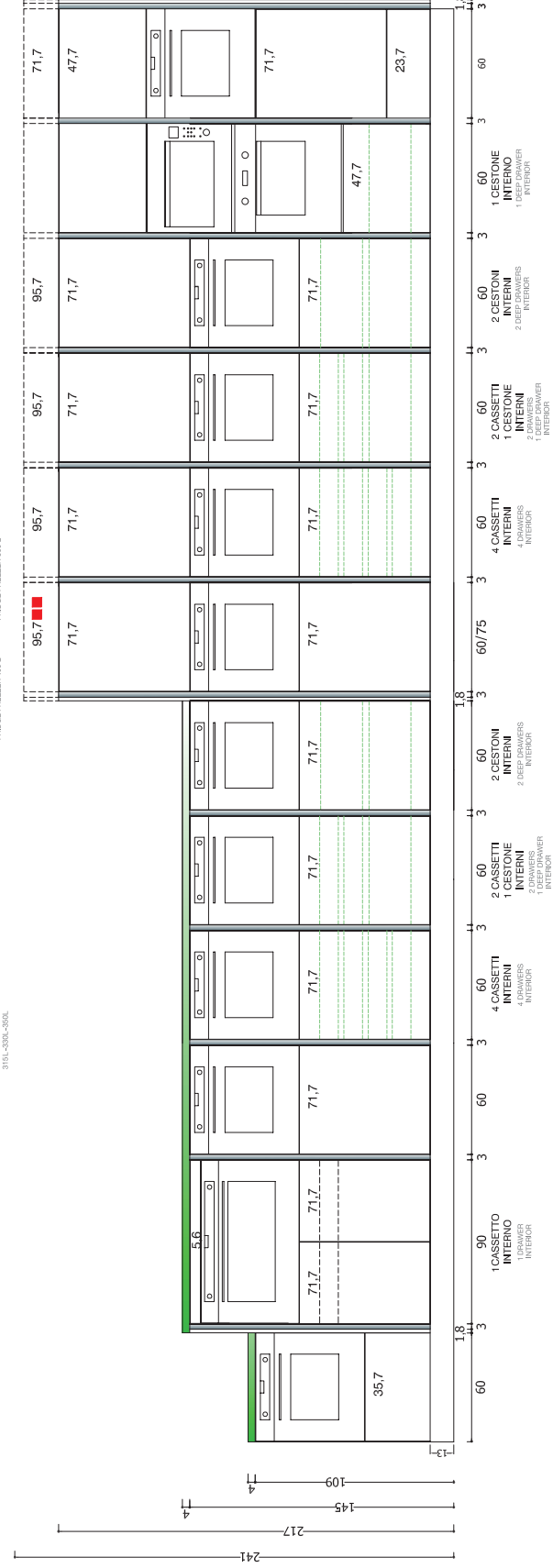
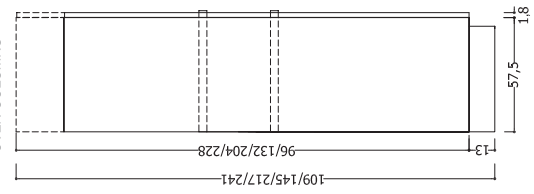

## BASI SOSPENSE

HANGING BASE UNITS

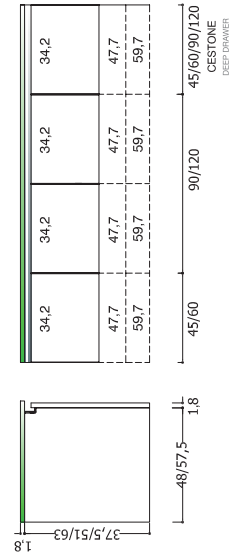

# MODULARITÀ E COMPONENTITÀ MODULARITÀ AND FITTING SOLUTIONS

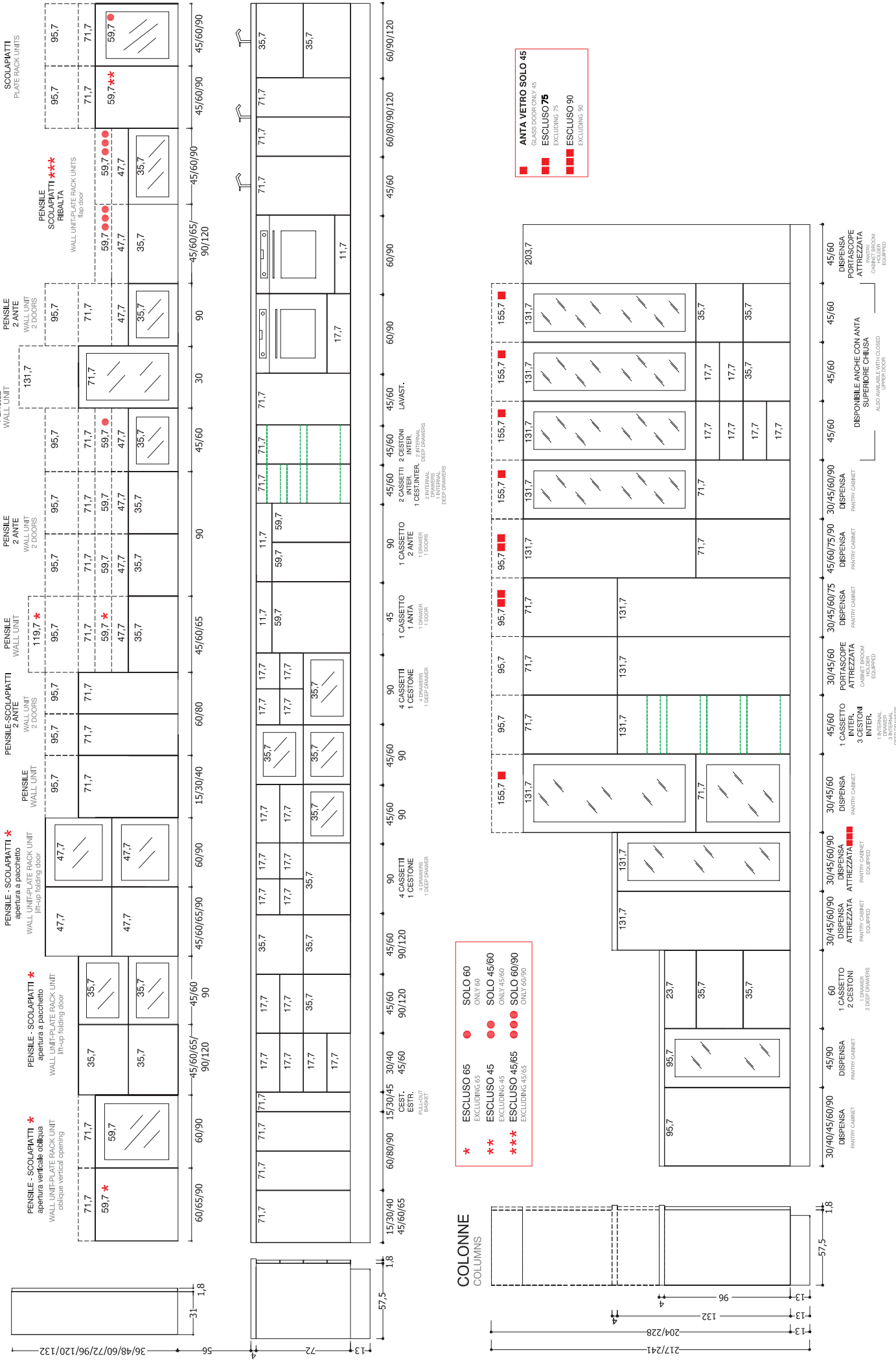









# PENSILI

WALL UNITS

P 33,1

**N.B.: cerniere ammortizzate di serie**  
Note: standard blumotion hinges

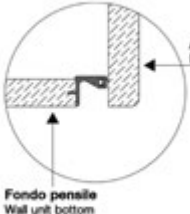

		COD.	NECK ALKOR- CELL KS2	NECK PET KS2	BRIDGE ALKOR- CELL KS1	BRIDGE PET KS1		
 <p><b>1 anta H 36</b> 1 door H 36</p>	L 45	E2030451/2	114	129	104	119		
	L 60	E2030601/2	122	140	112	130		
	L 65	E2030651/2	127	146	117	136		
 <p><b>1 anta H 48</b> 1 door H 48</p>	L 45	E2040451/2	128	147	118	137		
	L 60	E2040601/2	139	161	129	151		
	L 65	E2040651/2	147	169	137	159		
 <p><b>1 anta H 60</b> 1 door H 60</p>	L 45	E2060451/2	134	154	124	144		
	L 60	E2060601/2	147	171	137	161		
 <p><b>1 anta H 72</b> 1 door H 72</p>	L 15	E2010151/2	108	126	98	116		
	L 30	E2010301/2	130	148	120	108		
	L 40	E2010401/2	139	161	129	151		
	L 45	E2010451/2	141	164	131	154		
	L 60	E2010601/2	156	183	146	173		
	L 65	E2010651/2	161	189	151	179		
 <p><b>1 anta H 96</b> 1 door H 96</p>	L 15	E2020151/2	134	141	124	131		
	L 30	E2020301/2	149	171	139	161		
	L 40	E2020401/2	158	184	148	174		
	L 45	E2020451/2	164	192	154	182		
	L 60	E2020601/2	187	220	177	210		
	L 65	E2020651/2	193	228	183	218		
 <p><b>1 anta H 120</b> 1 door H 120</p>	L 30	E2145301/2	200	226	190	216		
	L 45	E2145451/2	220	252	210	242		
	L 60	E2145601/2	240	279	230	269		
 <p><b>Apertura senza maniglia, presa su fondo</b> - versione Neck: di serie - versione Bridge: in maggiorazione Grip on bottom opening, without handle - Neck version: standard - Bridge version: surcharge</p> <p><b>Presu su fondo (Opz.997)</b> Grip on bottom opening (code 997)</p> <p><b>Push Pull (Opz.996) 1 anta</b> Push Pull (code 996) 1 door</p> <p><b>Push Pull (Opz.996) 2 ante</b> Push Pull (code 996) 2 doors</p>								

# PENSILI

WALL UNITS

P 33,1

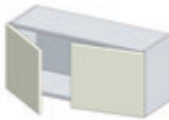
NECK - BRIDGE  
PENSILI - SCOLAPIAITI - CAPPE  
WALL - PLATE/RACK UNITS - HOODS

<b>N.B.: cerniere ammortizzate di serie</b> Note: standard blumotion hinges		COD.	NECK ALKOR- CELL KS2	NECK PET KS2	BRIDGE ALKOR- CELL KS1	BRIDGE PET KS1		
 <p><b>2 ante H 36</b> 2 doors H 36</p>	L 90	E2030900	184	216	174	206		
	 <p><b>2 ante H 48</b> 2 doors H 48</p>	L 90	E2040900	208	245	198	235	
 <p><b>2 ante H 60</b> 2 doors H 60</p>		L 90	E2060900	218	259	208	249	
	 <p><b>2 ante H 72</b> 2 doors H 72</p>	L 60	E2010600	202	239	192	229	
L 80		E2010800	226	271	216	261		
L 90		E2010900	231	277	221	267		
 <p><b>2 ante H 96</b> 2 doors H 96</p>	L 60	E2020600	231	276	221	266		
	L 80	E2020800	257	308	247	298		
	L 90	E2020900	269	324	259	314		
 <p><b>cestello estraibile chiusura soft</b> pull-out basket unit soft-closing system</p>	H 72 L 15	E2010150	144	163	134	153		
	H 96 L 15	E2020150	184	191	174	181		
 <p><b>fascia tamponamento</b> L da 3 a 15 filler panel size from 3 to 15</p>	H 60	E2790000	57	77	57	77		
	H 72	E2800000	57	77	57	77		
	H 96	E2810000	73	96	73	96		







# PENSILI

WALL UNITS

P 33,1

**N.B.: cerniere ammortizzate di serie**



Note: standard blumotion hinges

		COD.	NECK ALKOR- CELL KS2	NECK PET KS2	BRIDGE ALKOR- CELL KS1	BRIDGE PET KS1		
 <p><b>1 anta vetro H 36</b> 1 glass door H 36</p>	L 45	E1030451/2	135	160	125	150		
	L 60	E1030601/2	142	164	132	154		
 <p><b>1 anta vetro H 48</b> 1 glass door H 48</p>	L 45	E1040451/2	153	181	143	171		
	L 60	E1040601/2	167	199	157	189		
 <p><b>1 anta vetro H 60</b> 1 glass door H 60</p>	L 60	E1060601/2	165	198	155	188		
 <p><b>1 anta vetro H 72</b> 1 glass door H 72</p>	L 30	E1010301/2	145	170	135	160		
	L 45	E1010451/2	157	187	147	177		
	L 60	E1010601/2	179	216	169	206		
 <p><b>1 anta vetro H 96</b> 1 glass door H 96</p>	L 45	E1020451/2	187	224	177	214		
	L 60	E1020601/2	220	266	210	256		
 <p><b>1 anta vetro H 132</b> 1 glass door H 132</p>	L 30	E1025301/2	233	269	223	259		

# PENSILI

WALL UNITS

P 33,1



<b>N.B.: cerniere ammortizzate di serie</b> Note: standard blumotion hinges		COD.	NECK ALKOR- CELL KS2	NECK PET KS2	BRIDGE ALKOR- CELL KS1	BRIDGE PET KS1		
 <p><b>2 ante vetro H 36</b> 2 glass doors H 36</p>	L 90	E1030900	223	273	213	263		
 <p><b>2 ante vetro H 48</b> 2 glass doors H 48</p>	L 90	E1040900	254	311	244	301		
 <p><b>2 ante vetro H 72</b> 2 glass doors H 72</p>	L 90	E1010900	263	323	253	313		
 <p><b>2 ante vetro H 96</b> 2 glass doors H 96</p>	L 90	E1020900	315	389	305	379		
 <p><b>terminale H 72 31x31 a giorno tipo "A"</b> open end unit H 72 31x31 type "A"</p> <p>H 72</p>	H 72							
	colore come struttura same colour as carcass	E2620310	92	92	92	92		
 <p><b>terminale H 96 31x31 a giorno tipo "A"</b> open end unit H 96 31x31 type "A"</p> <p>H 96</p>	H 96							
	colore come struttura same colour as carcass	E2630310	109	109	109	109		



# PENSILI

WALL UNITS



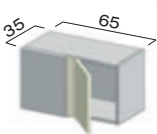
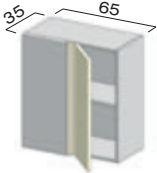
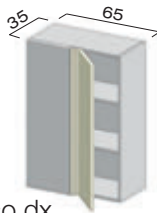

P 33,1

<b>N.B.: cerniere ammortizzate di serie</b> Note: standard blumotion hinges		COD.	NECK ALKOR- CELL KS2	NECK PET KS2	BRIDGE ALKOR- CELL KS1	BRIDGE PET KS1		
 <p><b>angolo H 36</b>  <b>2 ante a libretto</b>  <b>N.B.: fuori squadra realizzabili da 88° a 92°</b>                      corner unit H 36                      2 folding doors                      Note: out-of-plumb units available from 88° to 92°</p>	65X65	E2445651/2	264	297	254	287		
 <p><b>angolo H 72</b>  <b>2 ante a libretto</b>  <b>N.B.: fuori squadra realizzabili da 88° a 92°</b>                      corner unit H 72                      2 folding doors                      Note: out-of-plumb units available from 88° to 92°</p>	65X65	E2450651/2	304	343	284	323		
 <p><b>angolo H 96</b>  <b>2 ante a libretto</b>  <b>N.B.: fuori squadra realizzabili da 88° a 92°</b>                      corner unit H 96                      2 folding doors                      Note: out-of-plumb units available from 88° to 92°</p>	65X65	E2460651/2	360	404	340	384		
 <p><b>angolo H 36</b>  <b>1 anta</b>  <b>N.B.: fuori squadra realizzabili da 88° a 94°</b>                      corner unit H 36                      1 door                      Note: out-of-plumb units available from 88° to 94°</p> <p>verso dx RH version</p>	65X35	E2490651/2	197	210	187	200		
 <p><b>angolo H 72</b>  <b>1 anta</b>  <b>N.B.: fuori squadra realizzabili da 88° a 94°</b>                      corner unit H 72                      1 door                      Note: out-of-plumb units available from 88° to 94°</p> <p>verso dx RH version</p>	65X35	E2491651/2	263	298	253	288		
 <p><b>angolo H 96</b>  <b>1 anta</b>  <b>N.B.: fuori squadra realizzabili da 88° a 94°</b>                      corner unit H 96                      1 door                      Note: out-of-plumb units available from 88° to 94°</p> <p>verso dx RH version</p>	65X35	E2495651/2	327	354	317	344		

# PENSILI

WALL UNITS

P 33,1 - 47,1 - 59,6

<b>N.B.: cerniere ammortizzate di serie</b> Note: standard blumotion hinges		COD.	NECK	NECK	BRIDGE	BRIDGE		
			ALKOR-CELL KS2	PET KS2	ALKOR-CELL KS1	PET KS1		
 <p><b>angolo H 72</b>  <b>1 anta diagonale</b>                      corner unit H 72                      1 diagonal door</p>	65X65	E2400651/2	214	236	204	226		
		E2410651/2	252	280	242	270		
 <p><b>copriboiler H 72</b>  <b>1 anta</b>                      boiler housing H 72                      1 door</p>	L 60 P 33,1 L 60 P 47,1 L 60 P 59,6	E2150601/2	151	180	141	170		
		E2160601/2	205	235	195	225		
		E2170601/2	205	235	195	225		
 <p><b>copriboiler H 96</b>  <b>1 anta</b>                      boiler housing H 96                      1 door</p>	L 60 P 33,1 L 60 P 47,1 L 60 P 59,6	E2210601/2	170	205	160	195		
		E2220601/2	234	270	224	260		
		E2230601/2	234	270	224	260		
 <p><b>jolly pensile folding H 72</b>  <b>L da 10 a 30</b>                      folding jolly wall unit H 72                      size from 10 to 30</p>	colore come struttura same colour as carcass colore come anta alkorcell same colour as alkorcell door colore come anta PET same colour as PET door	E2700000	115	115	115	115		
		E2700030	194	—	194	—		
		E2700025	—	312	—	312		
 <p><b>jolly pensile folding H 96</b>  <b>L da 10 a 30</b>                      folding jolly wall unit H 96                      size from 10 to 30</p>	colore come struttura same colour as carcass colore come anta alkorcell same colour as alkorcell door colore come anta PET same colour as PET door	E2710000	140	140	140	140		
		E2710030	235	—	235	—		
		E2710025	—	395	—	395		

## PENSILE CON APERTURA A RIBALTA

Le ante aprendosi verso l'alto consentono di avere un' ampia visione d'insieme all'interno del mobile. In questo modo è possibile un comodo accesso agli oggetti contenuti al suo interno e, dal punto di vista ergonomico, molto vantaggioso. La regolazione della forza di apertura può essere impostata in modo esatto in base al peso del frontale. Grazie all'arresto progressivo le ante si fermano in qualsiasi posizione; in questo modo la maniglia è sempre facilmente raggiungibile. La chiusura è ammortizzata di serie.

### WALL UNIT WITH FLAP DOOR

The doors that open upwards guarantee ample overall visibility inside the cabinet. In this way, all objects housed inside the cabinet can be comfortably accessed, making the system highly advantageous from an ergonomic perspective. The opening force can be adjusted precisely according to the weight of the front. The doors stop in any position thanks to the gradual stopping movement; in this way, the handle is always easily accessible. The closing movement is cushioned standard.

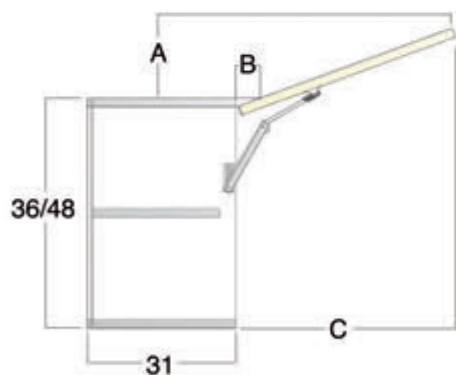



	A	B	C
H 36	7	4	37
H 48	11	4	49

# PENSILI RIBALTA CHIUSURA AMMORTIZZATA

P 33,1

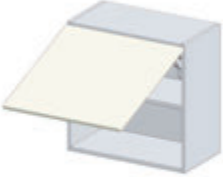
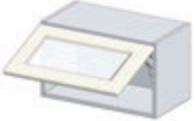
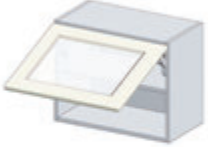
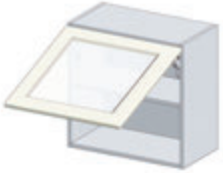

FLAP DOOR WALL UNITS BLUMOTION CLOSING SYSTEM

	COD.	NECK ALKOR- CELL KS2	NECK PET KS2	BRIDGE ALKOR- CELL KS1	BRIDGE PET KS1		
 <p><b>anta ribalta H 36</b> flap door H 36</p>	L 45	E2100450	147	163	137	153	
	L 60	E2100600	151	170	141	160	
	L 65	E2100650	156	174	146	164	
	L 90	E2100900	191	214	181	204	
	L 120	E2101200	220	248	210	238	
 <p><b>anta ribalta H 48</b> flap door H 48</p>	L 45	E2120450	162	181	152	171	
	L 60	E2120600	184	206	174	196	
	L 65	E2120650	192	205	182	195	
	L 90	E2120900	212	242	202	232	
	L 120	E212120C	284	317	274	307	
 <p><b>anta ribalta H 60</b> flap door H 60</p>	L 60	E212560C	229	259	219	249	
	L 90	E212590C	281	324	271	314	
 <p><b>anta vetro ribalta H 36</b> glass flap door H 36</p>	L 45	E1100450	171	195	161	185	
	L 60	E1100600	173	206	163	196	
	L 90	E1100900	217	240	207	230	
 <p><b>anta vetro ribalta H 48</b> glass flap door H 48</p>	L 45	E1120450	183	210	173	200	
	L 60	E1120600	214	243	204	233	
	L 90	E1120900	259	297	249	287	
 <p><b>anta vetro ribalta H 60</b> glass flap door H 60</p>	L 60	E113060C	249	282	239	272	
	L 90	E113090C	325	369	315	359	



Grazie al meccanismo TIP-ON, le ante a ribalta senza maniglia possono essere aperte semplicemente con un leggero tocco. Per chiudere l'anta a ribalta, è sufficiente esercitare una leggera pressione, che grazie ad una piastrina di bloccaggio, applicata sul lato interno del frontale, ne assicura la perfetta chiusura.

Thanks to TIP-ON mechanism, the flap doors without handles can be opened with a simple touch. To close the flap door, just exercise light pressure, thanks to the locking plate, applied on the inner side of the front panel ensures a perfect closure.

			COD.	NECK ALKOR- CELL KS2	NECK PET KS2	BRIDGE ALKOR- CELL KS1	BRIDGE PET KS1		
 <p><b>anta ribalta TIP-ON H 36</b> flap door TIP-ON H 36</p>									
	L 45	E210046T	149	165	149	165			
	L 60	E210061T	154	170	154	170			
	L 65	E210066T	157	176	157	176			
	L 90	E210091T	203	225	203	225			
L 120	E210121T	233	261	233	261				
 <p><b>anta ribalta TIP-ON H 48</b> flap door TIP-ON H 48</p>									
	L 45	E212046T	164	182	164	182			
	L 60	E212061T	201	222	201	222			
	L 65	E212066T	208	230	208	230			
	L 90	E212091T	225	253	225	253			
L 120	E212121T	288	322	288	322				
 <p><b>anta ribalta TIP-ON H 60</b> flap door TIP-ON H 60</p>									
	L 60	E212561T	241	265	241	265			
L 90	E212591T	294	325	294	325				

**APERTURA VERTICALE OBLIQUA**

I pensili con questo tipo di meccanismo necessitano per l'apertura di poco spazio libero sopra il mobile grazie al movimento basculante dell'anta che si apre senza difficoltà applicando poca forza anche in presenza di frontali pesanti. Con l'arresto progressivo le ante si fermano in qualsiasi posizione; in questo modo la maniglia è sempre facilmente raggiungibile. La chiusura è ammortizzata ed è possibile regolare la forza di tenuta in base al peso del frontale.

VERTICAL OPENING OBLIQUE

Wall units that mount this type of mechanism require little clearance above the cabinet thanks to the swivelling movement of the door that can be easily opened by applying slight pressure, even with heavy fronts. The doors stop in any position thanks to the gradual stopping movement; in this way, the handle is always easily accessible. The closing movement is cushioned and the closing force can be adjusted according to the weight of the front door.

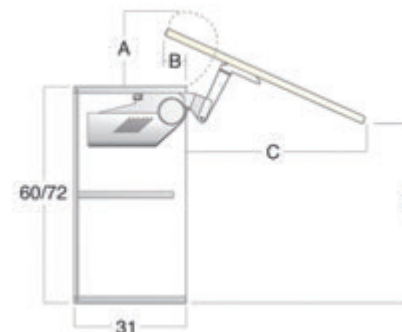

	A	B	C	D
H 60	18	9,6	46,5	53,5
H 72	18	9,6	57	61

**PENSILE CON APERTURA ANTE A PACCHETTO**

Il meccanismo d'apertura ante a pacchetto è idoneo sia sul pensile H 72 che H 96; la regolazione della forza di apertura può essere impostata in modo esatto in base ai pesi dei frontali, la chiusura è ammortizzata e la cerniera centrale clip si contraddistingue per l'innovativa tecnologia che garantisce la sicurezza per le dita.

WALL UNIT WITH LIFT-UP FOLDING DOORS

The lift-up folding door opening mechanism is suitable for wall units with H 72 or H 96; the opening force can be adjusted precisely according to the weight of the fronts, while the closing movement is cushioned and the central clip-on hinge features innovative technology for safeguarding the fingers.

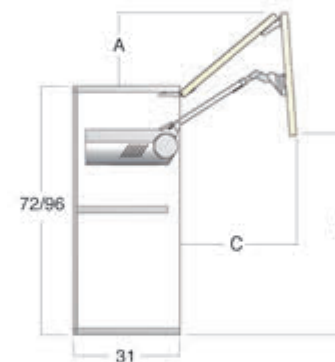



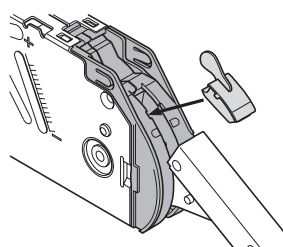

	A	B	C
H 72	16,5	54	41
H 96	20	69	53

**SCHEMA MONTAGGIO LIMITATORE**  
LIMITER INSTALLATION  
DIAGRAM



Per evitare l'interferenza dell'anta in fase di apertura con cornici o mensole, si può richiedere il limitatore dell'angolo di apertura cod. 5620005 € 10





In order to avoid that the door interferes with cornices or shelves during the opening movement, it is possible to request an opening angle limiter: code 5620005 € 10

	COD.	NECK ALKOR- CELL KS2	NECK PET KS2	BRIDGE ALKOR- CELL KS1	BRIDGE PET KS1		
<p><b>anta apertura verticale obliqua H 60</b> door with oblique vertical opening H 60</p> 							
	L 60 E2135600	291	316	281	306		
	L 90 E2135900	331	362	321	352		
<p><b>anta apertura verticale obliqua H 72</b> door with oblique vertical opening H 72</p> 							
	L 60 E2130600	306	333	296	323		
	L 65 E2130650	311	339	301	329		
	L 90 E2130900	335	383	325	373		
<p><b>anta vetro apertura verticale obliqua H 60</b> glass door with oblique vertical opening H 60</p> 							
	L 60 E1205600	310	342	300	332		
	L 90 E1205900	362	405	352	395		
<p><b>anta vetro apertura verticale obliqua H 72</b> glass door with oblique vertical opening H 72</p> 							
	L 60 E1200600	330	367	320	357		
	L 90 E1200900	391	445	381	435		

# PENSILI A PACCHETTO

WALL UNITS FOLDING DOORS

P 33,1



		COD.	NECK ALKOR- CELL KS2	NECK PET KS2	BRIDGE ALKOR- CELL KS1	BRIDGE PET KS1		
 <p><b>pensile H 72 apertura a pacchetto 2 ante H 36</b> wall unit H 72 lift-up folding door 2 doors H 36</p>	L 45	E2070450	329	363	319	353		
	L 60	E2070600	347	384	337	374		
	L 65	E2070650	352	391	342	381		
	L 90	E2070900	388	435	378	425		
	L 120	E2071200	442	499	432	489		
 <p><b>pensile H 72 apertura a pacchetto 2 ante vetro H 36</b> wall unit H 72 lift-up folding door 2 glass doors H 36</p>	L 45	E1070450	362	410	352	400		
	L 60	E1070600	375	416	365	406		
	L 90	E1070900	421	472	411	462		
 <p><b>pensile H 72 apertura a pacchetto 1 anta chiusa superiore H 36 1 anta vetro inferiore H 36</b> wall unit H 72 lift-up folding door 1 full upper door H 36 1 glass lower door H 36</p>	telaio alkorcell L 45 alkorcell frame	E2075450	346	363	336	353		
	L 60	E2075600	361	379	351	369		
	L 90	E2075900	405	428	395	418		
	telaio PET L 45 PET frame	E2075450	369	386	359	376		
	L 60	E2075600	382	400	372	390		
	L 90	E2075900	430	453	420	443		
 <p><b>pensile H 72 apertura a pacchetto 1 anta vetro superiore H 36 1 anta chiusa inferiore H 36</b> wall unit H 72 lift-up folding door 1 glass upper door H 36 1 full lower door H 36</p>	telaio alkorcell L 45 alkorcell frame	E2077450	346	363	336	353		
	L 60	E2077600	361	379	351	369		
	L 90	E2077900	405	428	395	418		
	telaio PET L 45 PET frame	E2077450	369	386	359	376		
	L 60	E2077600	382	400	372	390		
	L 90	E2077900	430	453	420	443		



# PENSILI A PACCHETTO

WALL UNITS FOLDING DOORS

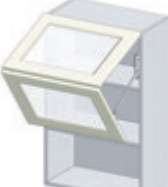
P 33,1

		COD.	NECK ALKOR- CELL KS2	NECK PET KS2	BRIDGE ALKOR- CELL KS1	BRIDGE PET KS1		
 <p><b>pensile H 96 apertura a pacchetto 2 ante H 48</b> wall unit H 96 lift-up folding door 2 doors H 48</p>								
	L 45	E2090450	362	399	352	389		
	L 60	E2090600	382	425	372	415		
	L 65	E2090650	389	434	379	424		
	L 90	E2090900	433	487	423	477		
 <p><b>pensile H 96 apertura a pacchetto 2 ante vetro H 48</b> wall unit H 96 lift-up folding door 2 glass doors H 48</p>								
	L 60	E1090600	422	483	412	473		
	L 90	E1090900	493	573	483	563		
 <p><b>pensile H 96 apertura a pacchetto 1 anta chiusa superiore H 48 1 anta vetro inferiore H 48</b> wall unit H 96 lift-up folding door 1 full upper door H 48 1 glass lower door H 48</p>								
	telaio alkorcell L 60 alkorcell frame	E2092600	402	424	392	414		
	L 90	E2092900	461	490	451	480		
	telaio PET L 60 PET frame	E2092600	432	454	422	444		
	L 90	E2092900	501	530	491	520		
 <p><b>pensile H 96 apertura a pacchetto 1 anta vetro superiore H 48 1 anta chiusa inferiore H 48</b> wall unit H 96 lift-up folding door 1 glass upper door H 48 1 full lower door H 48</p>								
	telaio alkorcell L 60 alkorcell frame	E2096600	402	424	392	414		
	L 90	E2096900	463	490	453	480		
	telaio PET L 60 PET frame	E2096600	432	454	422	444		
	L 90	E2096900	501	530	491	520		

# PENSILI PER MICRO

WALL UNITS FOR MICROWAVE OVENS

P 33,1

**N.B.: cerniere ammortizzate di serie**

Note: standard blumotion hinges

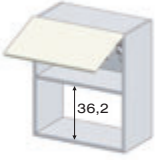
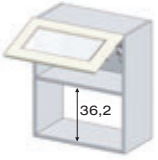
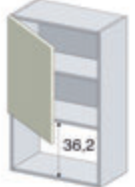
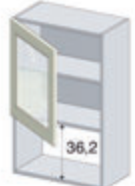





	COD.	NECK ALKOR- CELL KS2	NECK PET KS2	BRIDGE ALKOR- CELL KS1	BRIDGE PET KS1		
<p><b>pensile H 72</b> <b>1 anta ribalta H 36</b> <b>vano per micro Whirlpool</b> wall unit H 72 1 flap door H 36 housing for Whirlpool microwave</p> 							
	L 60	EPM20600	168	194	158	184	
<p><b>pensile H 72</b> <b>1 anta vetro ribalta H 36</b> <b>vano per micro Whirlpool</b> wall unit H 72 1 glass flap door H 36 housing for Whirlpool microwave</p> 							
	L 60	EPM10600	202	223	192	213	
<p><b>pensile H 96</b> <b>1 anta H 60</b> <b>vano per micro Whirlpool</b> wall unit H 96 1 door H 60 housing for Whirlpool microwave</p> 							
	L 60	EPM25601/2	171	203	161	193	
<p><b>pensile H 96</b> <b>1 anta vetro H 60</b> <b>vano per micro Whirlpool</b> wall unit H 96 1 glass door H 60 housing for Whirlpool microwave</p> 							
	L 60	EPM15601/2	197	230	187	220	

# SOPRAPENSILI

TOP UNITS

P 59,6









**N.B.: cerniere ammortizzate di serie**  
Note: standard blumotion hinges

	COD.	NECK ALKOR- CELL KS2	NECK PET KS2	BRIDGE ALKOR- CELL KS1	BRIDGE PET KS1		
 <p><b>soprapensile H 36</b> <b>1 anta</b> top unit H 36 1 door</p>	L 45	E2063451/2	159	175	149	165	
	L 60	E2063601/2	171	189	161	179	
 <p><b>soprapensile H 48</b> <b>1 anta</b> top unit H 48 1 door</p>	L 45	E2064451/2	195	213	185	203	
	L 60	E2064601/2	211	232	201	222	
 <p><b>soprapensile H 60</b> <b>1 anta</b> top unit H 60 1 door</p>	L 45	E2065451/2	198	219	188	209	
	L 60	E2065601/2	217	241	207	231	
 <p><b>soprapensile H 36</b> <b>2 ante</b> top unit H 36 2 doors</p>	L 90	E2063900	236	268	226	258	
 <p><b>soprapensile H 48</b> <b>2 ante</b> top unit H 48 2 doors</p>	L 90	E2064900	286	322	276	312	
 <p><b>soprapensile H 60</b> <b>2 ante</b> top unit H 60 2 doors</p>	L 90	E2065900	294	335	284	325	

# SCOLAPIATTI GRIGLIE ORION GRAU E RACCOGLIGOCCE PLASTICA

P 33,1





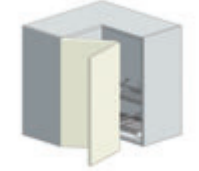

PLATE RACK UNITS ORION GRAU GRILLES AND PLASTIC DRIP TRAY

		COD.	NECK ALKOR- CELL KS2	NECK PET KS2	BRIDGE ALKOR- CELL KS1	BRIDGE PET KS1		
 <p><b>1 anta H 60</b> 1 door H 60</p>	L 60	E3060601/2	168	192	168	192		
	 <p><b>1 anta H 72</b> 1 door H 72</p>							
 <p><b>1 anta H 72</b> 1 door H 72</p>	L 45	E3010451/2	163	186	163	186		
	L 60	E3010601/2	177	204	177	204		
 <p><b>1 anta H 96</b> 1 door H 96</p>	L 45	E3020451/2	186	213	186	213		
	L 60	E3020601/2	212	245	212	245		
 <p><b>1 anta vetro H 60</b> 1 glass door H 60</p>	L 45	E320451/2	186	213	186	213		
	L 60	E320601/2	212	245	212	245		
 <p><b>1 anta vetro H 72</b> 1 glass door H 72</p>	L 45	E3210451/2	179	209	179	209		
	L 60	E3210601/2	201	237	201	237		
 <p><b>1 anta vetro H 96</b> 1 glass door H 96</p>	L 45	E3220451/2	209	246	209	246		
	L 60	E3220601/2	246	291	246	291		
 <p><b>Maggiorazione</b> kit luce LED DUAL COLOR calda (2700K) e naturale (4200K) interruttore ON/OFF "Touch" a sfioramento con alimentatore incluso <b>Surcharge</b> DUAL COLOR LED light kit warm (2700K) and natural (4200K) "Soft Touch" switch ON/OFF with power supplier</p>		opz.005						
	L 45		+100	+100	+100	+100		
	L 60		+105	+105	+105	+105		
	L 65		+105	+105	+105	+105		
	L 80		+115	+115	+115	+115		
	L 90		+115	+115	+115	+115		
L 120		+135	+135	+135	+135			

# SCOLAPIATTI GRIGLIE ORION GRAU E RACCOGLIGOCCE PLASTICA

P 33,1







PLATE RACK UNITS ORION GRAU GRILLES AND PLASTIC DRIP TRAY





		COD.	NECK ALKOR- CELL KS2	NECK PET KS2	BRIDGE ALKOR- CELL KS1	BRIDGE PET KS1			
 <p><b>2 ante H 60</b> 2 doors H 60</p>									
		L 90	E3060900	253	294	253	294		
 <p><b>2 ante H 72</b> 2 doors H 72</p>									
		L 60	E3010600	232	269	232	269		
		L 80	E3010800	259	304	259	304		
		L 90	E3010900	266	312	266	312		
 <p><b>2 ante H 96</b> 2 doors H 96</p>									
		L 60	E3020600	260	304	260	304		
		L 80	E3020800	289	340	289	340		
		L 90	E3020900	302	357	302	357		
 <p><b>2 ante vetro H 72</b> 2 glass doors H 72</p>									
		L 90	E3210900	298	358	298	358		
 <p><b>2 ante vetro H 96</b> 2 glass doors H 96</p>									
		L 90	E3220900	348	422	348	422		
 <p><b>angolo H 72</b> <b>2 ante a libretto</b> <b>N.B.: non si effettuano fuori squadra</b> corner unit H 72 2 folding doors Note: out-of-plumb units unavailable</p>									
		65X65	E3450651/2	436	474	436	474		
 <p><b>angolo H 96</b> <b>2 ante a libretto</b> <b>N.B.: non si effettuano fuori squadra</b> corner unit H 96 2 folding doors Note: out-of-plumb units unavailable</p>									
		65X65	E3460651/2	502	546	502	546		

# SCOLAPIATTI RIBALTA CHIUSURA AMMORTIZZATA

P 33,1

FLAP-DOOR PLATE RACK UNITS BLUMOTION CLOSING SYSTEM





		COD.	NECK ALKOR- CELL KS2	NECK PET KS2	BRIDGE ALKOR- CELL KS1	BRIDGE PET KS1		
 <p><b>anta ribalta H 36</b> <b>griglie orion grau e raccogligocce plastica</b> flap door H 36 orion grau grilles and plastic drip tray</p>	L 60	E3100600	168	185	168	185		
	L 90	E3100900	216	239	216	239		
	L 120	E3101205	268	296	268	296		
 <p><b>anta ribalta H 48</b> <b>griglie orion grau e raccogligocce plastica</b> flap door H 48 orion grau grilles and plastic drip tray</p>	L 60	E3120600	192	213	192	213		
	L 90	E3120900	228	255	228	255		
	L 120	E3121205	316	350	316	350		
 <p><b>anta ribalta H 60</b> <b>griglie orion grau e raccogligocce plastica</b> flap door H 60 orion grau grilles and plastic drip tray</p>	L 60	E312260C	248	272	248	272		
	L 90	E312290C	311	342	311	342		
 <p><b>anta vetro ribalta H 36</b> <b>griglie orion grau e raccogligocce plastica</b> glass flap door H 36 orion grau grilles and plastic drip tray</p>	L 60	E3130600	189	209	189	209		
	L 90	E3130900	241	265	241	265		
 <p><b>anta vetro ribalta H 48</b> <b>griglie orion grau e raccogligocce plastica</b> glass flap door H 48 orion grau grilles and plastic drip tray</p>	L 60	E3140600	220	250	220	250		
	L 90	E3140900	266	305	266	305		
 <p><b>anta vetro ribalta H 60</b> <b>griglie orion grau e raccogligocce plastica</b> glass flap door H 60 orion grau grilles and plastic drip tray</p>	L 60	E315060C	262	294	262	294		
	L 90	E315090C	318	361	318	361		

		COD.	NECK ALKOR- CELL KS2	NECK PET KS2	BRIDGE ALKOR- CELL KS1	BRIDGE PET KS1		
 <p><b>anta apertura verticale obliqua H 60</b> <b>griglie orion grau e raccogliocce plastica</b> door with vertical oblique opening H 60 orion grau grilles and plastic drip tray</p>	L 60	E3123600	305	329	305	329		
	L 90	E3123900	350	381	350	381		
 <p><b>anta apertura verticale obliqua H 72</b> <b>griglie orion grau e raccogliocce plastica</b> door with vertical oblique opening H 72 orion grau grilles and plastic drip tray</p>	L 60	E3125600	319	346	319	346		
	L 90	E3125900	365	401	365	401		
 <p><b>anta vetro apertura verticale obliqua H 60</b> <b>griglie orion grau e raccogliocce plastica</b> glass door with vertical oblique opening H 60 orion grau grilles and plastic drip tray</p>	L 60	E3205600	324	356	324	356		
	L 90	E3205900	381	424	381	424		
 <p><b>anta vetro apertura verticale obliqua H 72</b> <b>griglie orion grau e raccogliocce plastica</b> glass door with vertical oblique opening H 72 orion grau grilles and plastic drip tray</p>	L 60	E3200600	343	379	343	379		
	L 90	E3200900	409	463	409	463		
 <p><b>Maggiorazione</b> <b>kit luce LED DUAL COLOR calda (2700K) e naturale (4200K)</b> <b>interruttore ON/OFF "Touch" a sfioramento con alimentatore incluso</b> <b>Surcharge</b> DUAL COLOR LED light kit warm (2700K) and natural (4200K) "Soft Touch" switch ON/OFF with power supplier</p>		opz.005						
	L 45		+100	+100	+100	+100		
	L 60		+105	+105	+105	+105		
	L 65		+105	+105	+105	+105		
	L 80		+115	+115	+115	+115		
	L 90		+115	+115	+115	+115		
	L 120		+135	+135	+135	+135		

# SCOLAPIATTI APERTURA A PACCHETTO

PLATE RACK UNITS FOLDING DOORS

P 33,1





		COD.	NECK ALKOR- CELL KS2	NECK PET KS2	BRIDGE ALKOR- CELL KS1	BRIDGE PET KS1		
 <p><b>scolapiatti H 72 apertura a pacchetto 2 ante H 36</b> <b>griglie orion grau e raccogliocce plastica</b> plate rack unit H 72 lift-up folding door 2 doors H 36 orion grau grilles and plastic drip tray</p>	L 45	E3081450	345	376	345	376		
	L 60	E3081600	360	396	360	396		
	L 90	E3081900	407	453	407	453		
	L 120	E3082205	552	608	552	608		
 <p><b>scolapiatti H 72 apertura a pacchetto 2 ante vetro H 36</b> <b>griglie orion grau e raccogliocce plastica</b> plate rack unit H 72 lift-up folding door 2 glass doors H 36 orion grau grilles and plastic drip tray</p>	L 45	E3270450	375	423	375	423		
	L 60	E3270600	387	429	387	429		
	L 90	E3270900	439	490	439	490		
 <p><b>scolapiatti H 72 apertura a pacchetto 1 anta chiusa superiore H 36 1 anta vetro inferiore H 36</b> <b>griglie orion grau e raccogliocce plastica</b> plate rack unit H 72 lift-up folding door 1 full upper door H 36 1 glass lower door H 36 orion grau grilles and plastic drip tray</p>	telaio alkorcell L 45 alkorcell frame	E3085450	360	376	360	376		
	L 60	E3085600	374	392	374	392		
	L 90	E3085900	423	446	423	446		
	telaio PET L 45 PET frame	E3085450	383	399	383	399		
	L 60	E3085600	395	413	395	413		
	L 90	E3085900	448	471	448	471		
 <p><b>scolapiatti H 72 apertura a pacchetto 1 anta vetro superiore H 36 1 anta chiusa inferiore H 36</b> <b>griglie orion grau e raccogliocce plastica</b> plate rack unit H 72 lift-up folding door 1 glass upper door H 36 1 full lower door H 36 orion grau grilles and plastic drip tray</p>	telaio alkorcell L 45 alkorcell frame	E3087450	360	376	360	376		
	L 60	E3087600	374	392	374	392		
	L 90	E3087900	423	446	423	446		
	telaio PET L 45 PET frame	E3087450	383	399	383	399		
	L 60	E3087600	395	413	395	413		
	L 90	E3087900	448	471	448	471		



# SCOLAPIATTI APERTURA A PACCHETTO

PLATE RACK UNITS FOLDING DOORS





P 33,1

	COD.	NECK ALKOR- CELL KS2	NECK PET KS2	BRIDGE ALKOR- CELL KS1	BRIDGE PET KS1		
 <p><b>scolapiatti H 96 apertura a pacchetto 2 ante H 48</b> <b>griglie orion grau e raccogliocce plastica</b> plate rack unit H 96 lift-up folding door 2 doors H 48 orion grau grilles and plastic drip tray</p>	L 45	E3094450	376	412	376	412	
	L 60	E3094600	395	437	395	437	
	L 90	E3094900	451	505	451	505	
 <p><b>scolapiatti H 96 apertura a pacchetto 2 ante vetro H 48</b> <b>griglie orion grau e raccogliocce plastica</b> plate rack unit H 96 lift-up folding door 2 glass doors H 48 orion grau grilles and plastic drip tray</p>	L 60	E3290600	435	496	435	496	
	L 90	E3290900	511	591	511	591	
 <p><b>scolapiatti H 96 apertura a pacchetto 1 anta chiusa superiore H 48 1 anta vetro inferiore H 48</b> <b>griglie orion grau e raccogliocce plastica</b> plate rack unit H 96 lift-up folding door 1 full upper door H 48 1 glass lower door H 48 orion grau grilles and plastic drip tray</p>	telaio alkorcell L 60 alkorcell frame	E3095600	415	436	415	436	
	L 90	E3095900	481	508	481	508	
	telaio PET L 60 PET frame	E3095600	445	466	445	466	
	L 90	E3095900	521	548	521	548	
 <p><b>scolapiatti H 96 apertura a pacchetto 1 anta vetro superiore H 48 1 anta chiusa inferiore H 48</b> <b>griglie orion grau e raccogliocce plastica</b> plate rack unit H 96 lift-up folding door 1 glass upper door H 48 1 full lower door H 48 orion grau grilles and plastic drip tray</p>	telaio alkorcell L 60 alkorcell frame	E3097600	415	436	415	436	
	L 90	E3097900	481	508	481	508	
	telaio PET L 60 PET frame	E3097600	445	466	445	466	
	L 90	E3097900	521	548	521	548	
 <p><b>Maggiorazione</b> <b>kit luce LED DUAL COLOR calda (2700K) e naturale (4200K)</b> <b>interruttore ON/OFF "Touch" a sfioramento con alimentatore incluso</b> <b>Surcharge</b> DUAL COLOR LED light kit warm (2700K) and natural (4200K) "Soft Touch" switch ON/OFF with power supplier</p>	opz.005						
	L 45		+100	+100	+100	+100	
	L 60		+105	+105	+105	+105	
	L 65		+105	+105	+105	+105	
	L 80		+115	+115	+115	+115	
	L 90		+115	+115	+115	+115	
	L 120		+135	+135	+135	+135	

# CAPPE ASPIRANTI

EXTRACTOR HOODS

P 33,1

<b>N.B.: cerniere ammortizzate di serie</b> Note: standard blumotion hinges		COD.	NECK ALKOR- CELL KS2	NECK PET KS2	BRIDGE ALKOR- CELL KS1	BRIDGE PET KS1		
 <p><b>cappa estraibile 2 motori portata 275 m³/h con laterali in metallo, 1 anta</b>  <b>N.B.: posizionare la cappa ad una distanza non inferiore ai 65 cm dal piano cottura</b></p> <p>slide-out hood 2 motors air flow rate 275 m³/h with metal sides, 1 door  <b>Note: position the hood at least 65 cm from the cooker hob</b></p>	<b>H 63 L 60</b>	E3600601/2	309	339	309	339		
	<b>H 87 L 60</b>	E3610601/2	328	365	328	365		
	<b>n° 2 filtri carbone attivo</b> 2 active carbon filters		+24	+24	+24	+24		
 <p><b>cappa estraibile 2 motori portata 275 m³/h con laterali in metallo, 2 ante</b>  <b>N.B.: posizionare la cappa ad una distanza non inferiore ai 65 cm dal piano cottura</b></p> <p>slide-out hood 2 motors air flow rate 275 m³/h with metal sides, 2 doors  <b>Note: position the hood at least 65 cm from the cooker hob</b></p>	<b>H 63 L 90</b>	E3600900	400	449	400	449		
	<b>H 87 L 90</b>	E3610900	426	485	426	485		
	<b>n° 2 filtri carbone attivo</b> 2 active carbon filters		+24	+24	+24	+24		
 <p><b>cappa "Mod. F" integrata totale con frontalino vetro estraibile portata 390 m³/h con faretti a led 1 anta</b>  <b>N.B.: posizionare la cappa ad una distanza non inferiore ai 55 cm dal piano cottura</b></p> <p>"Mod. F" fully integrated hood with glass pull-out frontal panel air flow rate 390 m³/h, with led lights 1 door  <b>Note: position the hood at least 55 cm from the cooker hob</b></p>	<b>H 60 L 60</b>	EPC90461/2	492	511	492	511		
	<b>H 72 L 60</b>	EPC90561/2	498	521	498	521		
	<b>H 96 L 60</b>	EPC90661/2	529	557	529	557		
	<b>n° 2 filtri carbone attivo</b> 2 active carbon filters		08750894	31	31	31	31	
 <p><b>cappa "Mod. F" integrata totale con frontalino vetro estraibile portata 390 m³/h con faretti a led 2 ante</b>  <b>N.B.: posizionare la cappa ad una distanza non inferiore ai 55 cm dal piano cottura</b></p> <p>"Mod. F" fully integrated hood with glass pull-out front panel air flow rate 390 m³/h with led lights 2 doors  <b>Note: position the hood at least 55 cm from the cooker hob</b></p>	<b>H 60 L 90</b>	EPC90490	579	616	579	616		
	<b>H 72 L 90</b>	EPC90590	590	631	590	631		
	<b>H 96 L 90</b>	EPC90690	625	676	625	676		
	<b>n° 2 filtri carbone attivo</b> 2 active carbon filters		08750894	31	31	31	31	

# CAPPE ASPIRANTI

EXTRACTOR HOODS

P 33,1

**N.B.: cerniere ammortizzate di serie**

Note: standard blumotion hinges

**cappa "Mod. F" integrata totale con frontalino vetro estraibile portata 390 m³/h con faretti a led 1 anta apertura a ribalta**  
**N.B.: posizionare la cappa ad una distanza non inferiore ai 55 cm dal piano cottura**



"Mod. F" fully integrated hood with glass pull-out front panel  
 air flow rate 390 m³/h with led lights

1 flap door

Note: position the hood at least 55 cm from the cooker hob

H 36 L 60

COD.

NECK  
ALKOR-  
CELL  
KS2

NECK  
PET  
KS2

BRIDGE  
ALKOR-  
CELL  
KS1

BRIDGE  
PET  
KS1

EPC80260

503

519

503

519

H 36 L 90

EPC80290

562

583

562

583

H 36 L 120

EPC80320

647

675

647

675

H 48 L 60

EPC80360

696

715

696

715

H 48 L 90

EPC80390

743

768

743

768

H 48 L 120

EPC80420

831

865

831

865

H 60 L 60

EPC80460

570

591

570

591

H 60 L 90

EPC80490

644

673

644

673

n° 2 filtri carbone attivo

2 active carbon filters

08750894

31

31

31

31

**cappa "Mod. F" integrata totale con frontalino vetro estraibile portata 390 m³/h con faretti a led 2 ante apertura a pacchetto**  
**N.B.: posizionare la cappa ad una distanza non inferiore ai 55 cm dal piano cottura**

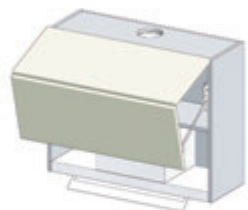

"Mod. F" fully integrated hood with glass pull-out front panel  
 air flow rate 390 m³/h with led lights

2 lift-up folding doors

Note: position the hood at least 55 cm from the cooker hob

H 72 L 60

EPC83560

700

732

700

732

H 72 L 90

EPC83590

759

801

759

801

H 72 L 120

EPC83620

866

922

866

922

H 96 L 60

EPC83660

737

776

737

776

H 96 L 90

EPC83690

806

856

806

856

n° 2 filtri carbone attivo

2 active carbon filters

08750894

31

31

31

31

**cappa "Mod. F" integrata totale con frontalino vetro estraibile portata 390 m³/h 1 anta apertura verticale obliqua**  
**N.B.: posizionare la cappa ad una distanza non inferiore ai 55 cm dal piano cottura**



"Mod. F" fully-integrated hood with glass pull-out front panel  
 flow rate 390 m³/h with led lights

1 door with vertical oblique opening

Note: position the hood at least 55 cm from the cooker hob

H 60 L 60

EPC86460

642

661

642

661

H 60 L 90

EPC86490

699

726

699

726

H 72 L 60

EPC86560

657

679

657

679

H 72 L 90

EPC86590

710

747

710

747

n° 2 filtri carbone attivo

2 active carbon filters

08750894

31

31

31

31

# CAPPE ASPIRANTI

EXTRACTOR HOODS

P 33,1

**N.B.: cerniere ammortizzate di serie**

Note: standard blumotion hinges

**Maggiorazione**  
**cappa "NO DRIP" incasso pensile**  
**portata 600 m<sup>3</sup>/h, per piano cottura ad**  
**induzione**  
**classe energetica A**

**Surcharge**  
 "NO DRIP" built in hood air flow rate 600 m<sup>3</sup>/h  
 recommended for induction cooker hob  
 energetic class A



L 60

opz.006

+537

+537

+537

+537

L 90

opz.006

+537

+537

+537

+537

L 120

opz.006

+657

+657

+657

+657

**filtro carbone attivo**  
 active carbon filter

08750844R

+44

+44







+44





+44

**PERCHÈ LA CAPPA "NO DRIP":**  
**a differenza dei tradizionali piani cottura a**  
**gas dove la fiamma riscalda le superfici della**  
**cappa, nei piani cottura ad induzione i vapori**  
**condensano velocemente sulle superfici**  
**"fredde" della stessa, generando così gocce**  
**d'acqua che cadono sul p.c. sottostante.**  
**LA CAPPA "NO DRIP" È LA SOLUZIONE A**  
**QUESTO PROBLEMA.**



**WHY THE "NO DRIP" HOOD:**  
 unlike traditional gas hobs where the flame heats the  
 surfaces of the hood, with induction hobs the vapors  
 quickly condense on the "cold" surfaces of the hood, thus  
 generating drops of water that fall on the hob below.  
 THE "NO DRIP" HOOD IS THE SOLUTION TO THIS  
 PROBLEM.

<b>Le basi non sono comprensive di top - N.B.: cerniere ammortizzate di serie</b> The base units do not include the tops - Note: standard blumotion hinges		COD.	NECK ALKOR- CELL KS2	NECK PET KS2			
 <p><b>fascia tamponamento</b> filler panel</p>	<b>L da 3 a 15</b> size from 3 to 15	G4800000	65	75			
	 <p><b>jolly base folding</b> <b>L da 10 a 30</b> folding jolly base unit size from 10 to 30</p>	<b>colore come struttura</b> same colour as carcass	G4700000	130	130		
<b>colore come anta alkorcell</b> same colour as alkorcell door		G4700030	253	—			
<b>colore come anta PET</b> same colour as PET door		G4700025	—	437			
 <p><b>1 anta</b> 1 door</p>	<b>L 15</b>	G4010151/2	132	150			
	<b>L 30</b>	G4010301/2	148	166			
	<b>L 40</b>	G4010401/2	165	188			
	<b>L 45</b>	G4010451/2	172	195			
	<b>L 60</b>	G4010601/2	195	222			
	<b>L 65</b>	G4010651/2	206	235			
 <p><b>2 ante</b> 2 doors</p>	<b>L 60</b>	G4010600	235	273			
	<b>L 80</b>	G4010800	270	316			
	<b>L 90</b>	G4010900	282	328			
 <p><b>cestello estraibile</b> <b>chiusura soft</b> pull-out basket unit soft-closing system</p>	<b>L 15</b>	G4150150	161	179			
	<b>L 30</b>	G4150300	221	240			
	<b>L 45</b>	G4150450	248	271			
 <p><b>4 cassetti H 16,9</b> 4 drawers H 16,9</p>	<b>L 30</b>	G4100300	385	419			
	<b>L 40</b>	G4100400	404	442			
	<b>L 45</b>	G4100450	419	458			
	<b>L 60</b>	G4100600	460	504			
 <p><b>2 cassetti H 16,9</b> <b>1 cestone H 34,2</b> 2 drawers H 16,9 1 deep drawer H 34,2</p>	<b>L 45</b>	G4130450	369	404			
	<b>L 60</b>	G4130600	406	446			
	<b>L 90</b>	G4130900	500	549			
	<b>L 120</b>	G4131200	564	623			

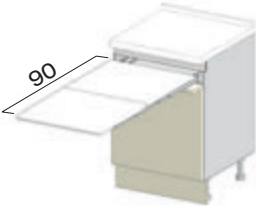
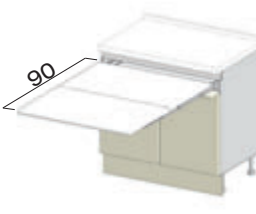
<b>Le basi non sono comprensive di top - N.B.: cassetti e cestoni ad estrazione totale con blumotion</b> The base units do not include the tops - Note: fully extending drawers and deep drawers with blumotion system		COD.	NECK ALKOR- CELL KS2	NECK PET KS2			
 <p><b>4 cassetti H 16,9</b> <b>1 cestone H 34,2</b> 4 drawers H 16,9 1 deep drawer H 34,2</p>	L 90	G4300900	664	726			
	<p><b>portaposate in plastica per cassetti</b> plastic cutlery tray for drawers</p> 		L 30	08700030X	10	10	
		L 40	08700040X	10	10		
		L 45	08700050X	10	10		
		L 60	08700060X	11	11		
		L 90	08700070X	32	32		
		L 120	08700075X	40	40		
<p><b>divisori regolabili L 90</b> adjustable separators</p> <p><b>divisori regolabili L 120</b> adjustable separators</p>							
 <p><b>2 cestoni H 34,2</b> 2 deep drawers H 34,2</p>	L 45	G4170450	323	354			
	L 60	G4170600	357	393			
	L 90	G4170900	456	502			
	L 120	G4171200	485	540			
 <p><b>1 anta</b> <b>2 cassetti interni</b> <b>1 cestone interno</b> <b>posizionare a 5 cm dalla parete laterale</b> 1 door 2 internal drawers 1 internal deep drawer <b>place at 5 cm from the side wall</b></p>	L 45	G4210461/2	385	407			
	L 60	G4210611/2	440	467			
 <p><b>1 anta</b> <b>2 cestoni interni</b> <b>posizionare a 5 cm dalla parete laterale</b> 1 door 2 internal deep drawers <b>place at 5 cm from the side wall</b></p>	L 45	G4210471/2	343	366			
	L 60	G4210621/2	378	405			
 <p><b>base tavolo estraibile LUNCH</b> <b>portata 60 kg</b> <b>1 anta H 54,5 apertura push-pull</b> <b>1 frontale H 16,9</b> base unit with pull-out table LUNCH load capacity kg 60 1 door H 54,5 push-pull opening 1 front H 16,9</p>	L 60	G4230601/2	711	745			
	L 90	G4230900	781	833			
 <p><b>base tavolo estraibile LUNCH</b> <b>portata 60 kg</b> <b>2 ante H 54,5 apertura push-pull</b> <b>1 frontale H 16,9</b> base unit with pull-out table LUNCH load capacity kg 60 2 doors H 54,5 push-pull opening 1 front H 16,9</p>	L 90	G4230900	781	833			

# BASI ANGOLO

CORNER BASE UNITS

H 88 P 65

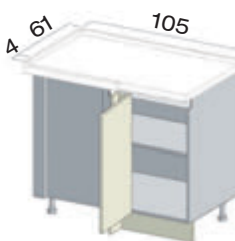
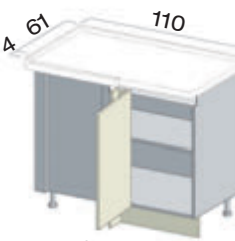
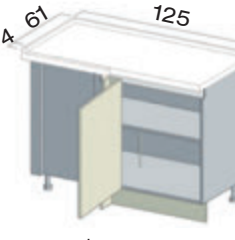
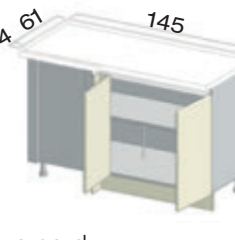
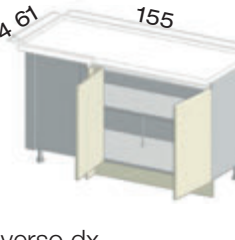

**Le basi non sono comprensive di top - N.B.: cerniere ammortizzate di serie**  
 The base units do not include the tops - Note: standard blumotion hinges

		COD.	NECK ALKOR- CELL KS2	NECK PET KS2			
 <p><b>angolo L 95</b>  <b>1 ripiano</b>  <b>1 anta L 30 (cerniere a pilastro)</b>  <b>cassone 90</b>                      corner unit W 95                      1 shelf                      1 door W 30 (pillar hinges)                      structure 90</p> <p>verso dx RH version</p>	95x65	G4400951/2	341	399			
 <p><b>angolo L 105</b>  <b>1 ripiano</b>  <b>1 anta L 40 (cerniere a pilastro)</b>  <b>cassone 90</b>                      corner unit W 105                      1 shelf                      1 door W 40 (pillar hinges)                      structure 90</p> <p>verso dx RH version</p>	105x65	G4401041/2	352	414			
 <p><b>angolo L 110</b>  <b>1 ripiano</b>  <b>1 anta L 45 (cerniere a pilastro)</b>  <b>cassone 105</b>                      corner unit W 110                      1 shelf                      1 door W 45 (pillar hinges)                      structure 105</p> <p>verso dx RH version</p>	110x65	G4401091/2	367	429			
 <p><b>angolo L 125</b>  <b>1 ripiano</b>  <b>1 anta L 60 (cerniere a pilastro)</b>  <b>cassone 120 con tirante</b>                      corner unit W 125                      1 shelf                      1 door W 60 (pillar hinges)                      structure 120 with tie beam</p> <p>verso dx RH version</p>	125x65	G4401241/2	402	468			
 <p><b>angolo L 145</b>  <b>1 ripiano</b>  <b>2 ante L 40 (cerniere a pilastro)</b>  <b>cassone 140 con tirante</b>                      corner unit W 145                      1 shelf                      2 doors W 40 (pillar hinges)                      structure 140 with tie beam</p> <p>verso dx RH version</p>	145x65	G4401451/2	487	571			
 <p><b>angolo L 155</b>  <b>1 ripiano</b>  <b>2 ante L 45 (cerniere a pilastro)</b>  <b>cassone 150 con tirante</b>                      corner unit W 155                      1 shelf                      2 doors W 45 (pillar hinges)                      structure 150 with tie beam</p> <p>verso dx RH version</p>	155x65	G4401551/2	495	580			

# BASI ANGOLO

CORNER BASE UNITS

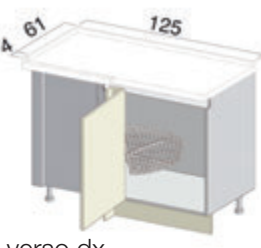
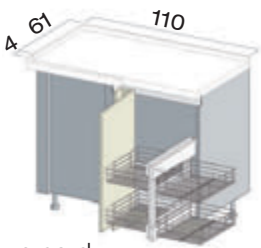
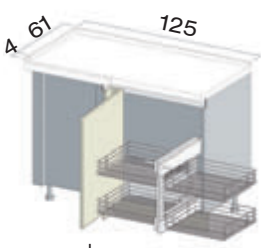
H 88 P 65

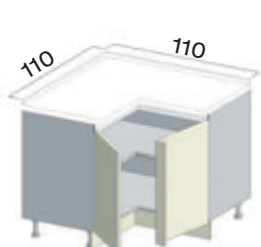
Le basi non sono comprensive di top - N.B.: cerniere ammortizzate di serie The base units do not include the tops - Note: standard blumotion hinges		COD.	NECK ALKOR- CELL KS2	NECK PET KS2			
 <p><b>angolo L 110</b> <b>cestello mezzaluna orion grau</b> <b>1 anta L 45 (cerniere a pilastro)</b> <b>cassone 105</b> corner unit W 110 crescent-shaped orion grau wire basket unit 1 door W 45 (pillar hinges) structure 105</p> <p>verso dx RH version</p>	<p><b>1 cestello 110x65</b> 1 basket drawer</p> <p><b>2 cestelli 110x65</b> 2 basket drawers</p>	G4401101/2	373	435			
		G4401111/2	401	463			
 <p><b>angolo L 125</b> <b>cestello mezzaluna orion grau</b> <b>1 anta L 60 (cerniere a pilastro)</b> <b>cassone 120</b> corner unit W 125 crescent-shaped orion grau wire basket units 1 door W 60 (pillar hinges) structure 120</p> <p>verso dx RH version</p>	<p><b>1 cestello 125x65</b> 1 basket drawer</p> <p><b>2 cestelli 125x65</b> 2 basket drawers</p>	G4401251/2	392	458			
		G4401261/2	421	487			
 <p><b>angolo L 110</b> <b>4 cestelli orion grau estraibili indipendenti dall'anta</b> <b>1 anta L 45 (cerniere a pilastro)</b> <b>cassone 105</b> corner unit W 110 4 pull-out orion grau basket units opening independently from door 1 door W 45 (pillar hinges) structure 105</p> <p>verso dx RH version</p>	<p><b>110x65</b></p>	G4451101/2	883	945			
 <p><b>angolo L 125</b> <b>4 cestelli orion grau estraibili indipendenti dall'anta</b> <b>1 anta L 60 (cerniere a pilastro)</b> <b>cassone 120</b> corner unit W 125 4 pull-out orion grau basket units opening independently from door 1 door W 60 (pillar hinges) structure 120</p> <p>verso dx RH version</p>	<p><b>125x65</b></p>	G4451251/2	952	1.018			
 <p><b>angolo 95x95</b> <b>1 ripiano</b> <b>2 ante L 30 (cerniere 180°)</b> <b>angolare unito all'anta dx</b> corner unit 95x95 1 shelf 2 doors W 30 (180° hinges) angular filler attached to the RH door</p>	<p><b>95x95</b></p>	G4480950	648	727			
 <p><b>angolo 110x110</b> <b>1 ripiano</b> <b>2 ante L 45 (cerniere 180°)</b> <b>angolare unito all'anta dx</b> corner unit 110x110 1 shelf 2 doors W 45 (180° hinges) angular filler attached to the RH door</p>	<p><b>110x110</b></p>	G4481100	707	794			





# BASI ANGOLO PANNELLO COME ANTA

H 88 P 61

CORNER BASE UNITS PANEL AS DOOR

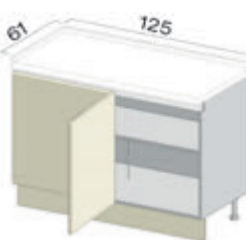

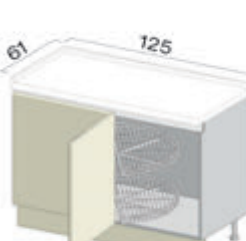
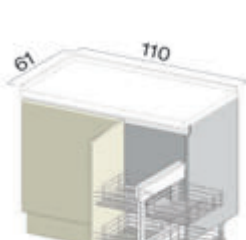
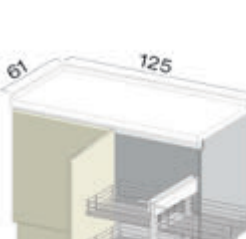
**LE BASI NON SONO COMPRENSIVE DI TOP**  
THE BASE UNITS DO NOT INCLUDE THE TOPS

		COD.	NECK ALKOR- CELL KS2	NECK PET KS2			
 <p><b>angolo L 110</b> <b>1 ripiano</b> <b>1 anta L 45</b> <b>pannello come anta</b> <b>cassone 110</b> corner unit W 110 1 shelf 1 door W 45 panel as door structure 110</p> <p>verso dx RH version</p>							
	110x61	G4403091/2	375	421			
 <p><b>angolo L 125</b> <b>1 ripiano</b> <b>1 anta L 60</b> <b>pannello come anta</b> <b>cassone 125 con tirante</b> corner unit W 125 1 shelf 1 door W 60 panel as door structure 125 with tie beam</p> <p>verso dx RH version</p>							
	125x61	G4403241/2	388	438			
 <p><b>angolo L 110</b> <b>2 cestelli mezzaluna orion grau</b> <b>1 anta L 45</b> <b>pannello come anta</b> <b>cassone 110</b> corner unit W 110 2 crescent-shaped orion grau wire basket units 1 door W 45 panel as door structure 110</p> <p>verso dx RH version</p>							
	110x61	G4403111/2	399	445			
 <p><b>angolo L 125</b> <b>2 cestelli mezzaluna orion grau</b> <b>1 anta L 60</b> <b>pannello come anta</b> <b>cassone 125</b> corner unit W 125 2 crescent-shaped orion grau wire basket units 1 door W 60 panel as door structure 125</p> <p>verso dx RH version</p>							
	125x61	G4403261/2	412	462			
 <p><b>angolo L 110</b> <b>4 cestelli orion grau estraibili indipendenti dall'anta</b> <b>1 anta L 45</b> <b>pannello come anta</b> <b>cassone 110</b> corner unit W 110 4 pull-out orion grau basket units opening independently from door 1 door W 45 panel as door structure 110</p> <p>verso dx RH version</p>							
	110x61	G4453101/2	885	955			
 <p><b>angolo L 125</b> <b>4 cestelli orion grau estraibili indipendenti dall'anta</b> <b>1 anta L 60</b> <b>pannello come anta</b> <b>cassone 125</b> corner unit W 125 4 pull-out orion grau basket units opening independently from door 1 door W 60 panel as door structure 125</p> <p>verso dx RH version</p>							
	125x61	G4453251/2	948	1.022			

# BASI PER FORNI

OVEN BASE UNITS

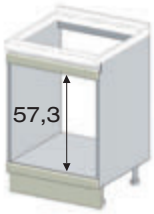
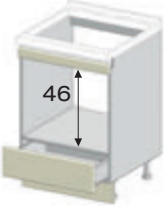
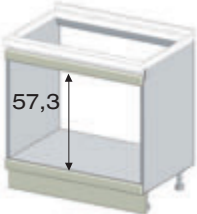
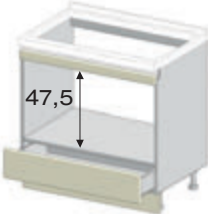





H 88 P 61

Le basi non sono comprensive di top - N.B.: cassetti ad estrazione totale con blumotion The base units do not include the tops - Note: fully extending drawers with blumotion system		COD.	NECK ALKOR- CELL KS2	NECK PET KS2			
 <p><b>base per forno elettrico e gas H 60</b> <b>fascia superiore e inferiore H 5,7</b> electric and gas oven base unit H 60 upper and lower panel H 5,7</p>	L 60	G5510600	155	172			
	 <p><b>base per forno elettrico H 46</b> <b>fascia superiore H 8,9</b> <b>cassetto inferiore H 16,9</b> <b>presa su fondo</b> electric oven base unit H 46 upper panel H 8,9 lower drawer H 16,9 grip on bottom opening</p>	L 60	G5530600	139	156		
 <p><b>base per maxiforno H 60</b> <b>fascia superiore e inferiore H 5,7</b> maxi-oven base unit H 60 upper and lower panel H 5,7</p>		L 90	G5510900	190	202		
	 <p><b>base per maxiforno H 48</b> <b>fascia superiore H 6,7</b> <b>cassetto inferiore H 16,9</b> <b>presa su fondo</b> maxi-oven base unit H 48 upper panel H 6,7 lower drawer H 16,9 grip on bottom opening</p>	L 90	G5530900	170	189		
 <p><b>kit raccordo base angolo</b> junction kit for corner base unit</p>		110x110	G5471100	202	241		
	 <p><b>kit raccordo base angolo per inserimento lavastoviglie a destra o sinistra</b> junction kit for corner base unit for dishwasher placed on the right or the left side</p> <p>verso dx RH version</p>	110x110	G5471151/2	235	274		

# BASI PER PIANI COTTURA

COOKER HOB BASE UNITS





H 88 P 61

Le basi non sono comprensive di top The base units do not include the tops		COD.	NECK ALKOR- CELL KS2	NECK PET KS2				
 <p><b>base predisposta piano cottura 1 anta</b> base unit configured for cooker hob 1 door</p>	L 60	G5500601/2	200	227				
		opz.101	+55	+55				
	<p><b>mag.base piano cottura ad induzione</b> surcharge base unit for induction cooker hob</p>							
 <p><b>base predisposta piano cottura 2 ante</b> base unit configured for cooker hob 2 doors</p>	L 90	G5500900	286	332				
		opz.101	+55	+55				
	<p><b>mag.base piano cottura ad induzione</b> surcharge base unit for induction cooker hob</p>							
 <p><b>Maggiorazione per base predisposta piano cottura ad induzione con lamierino di protezione</b> <b>N.B.: realizzabile su base 2 cassetti+1 cestone, base 2 cestoni e base 4 cassetti</b> Surcharge for base unit configured for induction cooker hob with protection metal sheet Note: available on base unit 2 drawers+1 deep drawer, base unit 2 deep drawers and base unit 4 drawers</p>		opz.101	+55	+55				
 <p><b>base predisposta piano cottura con cappa integrata</b> <b>1 frontale superiore fisso H 16,9</b> <b>1 cassetto H 16,9 P 40</b> <b>1 cestone H 34,2 P 40</b> base unit configured for cooker hob with integrated hood 1 fixed upper front H 16,9 1 drawer H 16,9 D 40 1 deep drawer H 34,2 D 40</p>	L 90	G5509090	448	498				
	L 120	G5509120	557	616				
 <p><b>base predisposta piano cottura con cappa integrata</b> <b>2 cestoni H 34,2 P 40</b> base unit configured for cooker hob with integrated hood 2 deep drawers H 34,2 D 40</p>	L 90	G5509095	446	491				
	L 120	G5509125	541	596				
 <p><b>Esempio di piano cottura con cappa integrata</b> Example of cooker hob with integrated hood</p>								

# SOTTOLAVELLI

SINK BASE UNITS

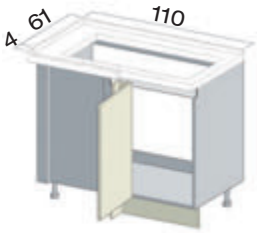
H 88 P 61

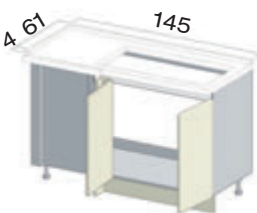
Le basi non sono comprensive di top - N.B.: cerniere ammortizzate di serie The base units do not include the tops - Note: standard blumotion hinges		COD.	NECK ALKOR- CELL KS2	NECK PET KS2			
 <p><b>sottolavello 1 anta</b> sink base unit 1 door</p>	L 45	G5010451/2	170	193			
	L 60	G5010601/2	191	218			
 <p><b>sottolavello 2 ante</b> sink base unit 2 doors</p>	L 60	G5010600	230	267			
	L 80	G5010800	265	311			
	L 90	G5010900	274	320			
	L 120	G5011200	322	376			
 <p><b>sottolavello 2 cestoni H 34,2 cestone superiore sagomato con vaschette</b> sink base unit 2 deep drawers H 34,2 contoured upper deep drawer with trays</p>	L 60	G5200600	389	425			
	L 90	G5200900	483	529			
	L 120	G5201200	533	588			
 <p><b>sottolavello angolo L 110 1 anta L 45 (cerniere pilastro) cassone 105</b> corner sink base unit W 110 1 door W 45 (pillar hinges) structure 105</p> <p>verso dx RH version</p>	110x65	G4421101/2	349	410			
		G4421251/2	370	436			
 <p><b>sottolavello angolo L 125 1 anta L 60 (cerniere pilastro) cassone 120</b> corner sink base unit W 125 1 door W 60 (pillar hinges) structure 120</p> <p>verso dx RH version</p>	125x65	G4421251/2	370	436			
		G4421451/2	433	517			
 <p><b>sottolavello angolo L 145 2 ante L 40 (cerniere pilastro) cassone 140</b> corner sink base unit W 145 2 doors W 40 (pillar hinges) structure 140</p> <p>verso dx RH version</p>	145x65	G4421451/2	433	517			

# SOTTOLAVELLI

SINK BASE UNITS

H 88 P 61

**Le basi non sono comprensive di top - N.B.: cerniere ammortizzate di serie**  
 The base units do not include the tops - Note: standard blumotion hinges



verso dx  
 RH version

**sottolavello angolo L 155**  
**2 ante L 45 (cerniere pilastro)**  
**cassone 150**  
 corner sink base unit W 155  
 2 doors W 45 (pillar hinges)  
 structure 150

155x65

COD.

NECK  
 ALKOR-  
 CELL  
 KS2

NECK  
 PET  
 KS2

G4421551/2

451

536

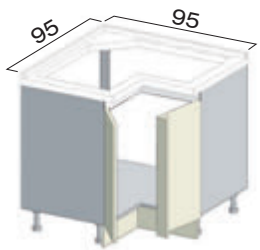

**sottolavello angolo 95x95**  
**2 ante L 30 (cerniere 180°)**  
**angolare unito all'anta dx**  
 corner sink base unit 95x95  
 2 doors W 30 (180° hinges)  
 angular filler attached to the RH door

95x95

G5020950

633

709

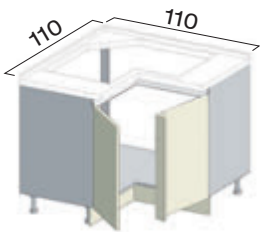

**sottolavello angolo 110x110**  
**2 ante L 45 (cerniere 180°)**  
**angolare unito all'anta dx**  
 corner sink base unit 110x110  
 2 doors W 45 (180° hinges)  
 angular filler attached to the RH door

110x110

G5021100

700







785

**NELLE INTERRUZIONI DI GOLA, AGGIUNGERE**  
**SEMPRE I RELATIVI TERMINALI**  
 ADD. THE ASSOCIATED CLOSURES TO ANY  
 INTERRUPTIONS IN THE FINGER RAIL

# BASI PER ELETTRODOMESTICI SOTTOTOP

BASE UNITS FOR UNDER-TOP APPLIANCES

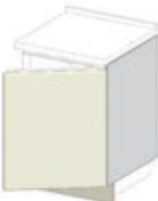
H 88 P 61





Le basi non sono comprensive di top The base units do not include the tops		COD.	NECK ALKOR- CELL KS2	NECK PET KS2				
 <p><b>anta per lavastoviglie scomparsa totale completa di kit protezione fianchi</b> door for fully integrated dishwasher with protection kit for side panels</p>	L 45	G4490080	123	147				
	L 60	G4490090	137	166				
 <p><b>anta per lavastoviglie a scomparsa totale estetica 2 cestoni completa di kit protezione fianchi</b> door for aesthetic fully integrated dishwasher 2 deep drawers with protection kit for side panels</p>	L 60	G4490300	377	417				
	 <p><b>kit protezione fianchi per lavastoviglie</b> protection kit for side panels for dishwasher</p> 							
 <p><b>anta per lavabiancheria scomparsa totale</b> door for fully integrated washing machine</p>	L 60	G4490011/2	137	166				
	 <p><b>anta con fianco per frigo e congelatore sottotop</b> door with side panel for under-top fridge and freezer</p>	L 60	G4490151/2	162	191			
 <p><b>anta per frigo e congelatore sottotop</b> door for under-top fridge and freezer</p>		L 60	G4490181/2	137	166			
	 <p><b>fianco per elettrodomestici a fine composizione</b> side panel for appliances placed at the end of the composition</p>	<p><b>H 88x60x1,8 zoccolo H 13</b> <b>in nobilitato</b> melamine coated</p>		G94612	29	29		
<p><b>H 88x59,6x1,8 zoccolo H 13</b> <b>alkorcell come anta</b> alkorcell same as door</p>		G94704	73	—				
<p><b>PET come anta</b> PET same as door</p>		G94704	—	104				

# BASI H 76

BASE UNITS H 76

H 76 P 61

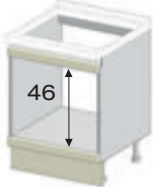

**Le basi non sono comprensive di top - N.B.: cerniere ammortizzate di serie**  
 The base units do not include the tops - Note: standard blumotion hinges

	COD.	NECK ALKOR- CELL KS2	NECK PET KS2				
 <p><b>base H 76 1 anta</b> base unit H 76 1 door</p>	L 45	G4030451/2	172	193			
	L 60	G4030601/2	199	223			
 <p><b>base H 76 2 ante</b> base unit H 76 2 doors</p>	L 90	G4030900	285	327			
	L 120	G4031200	346	396			
 <p><b>base H 76 1 cassetto H 22,2 2 cassetti H 16,9</b> base unit H 76 1 drawer H 22,2 2 drawers H 16,9</p>	L 45	G4255450	351	384			
	L 60	G4255600	397	434			
	L 90	G4255900	485	530			
	L 120	G4256200	561	614			
 <p><b>base H 76 1 cassetto H 22,2 1 cassetto H 34,2</b> base unit H 76 1 drawer H 22,2 1 deep drawer H 34,2</p>	L 45	G4260450	300	329			
	L 60	G4260600	337	370			
	L 90	G4260900	428	469			
	L 120	G4261200	465	515			
 <p><b>base H 76 predisposta per forno elettrico compatto H 46</b> <b>1 fascia superiore H 7,4</b> <b>1 fascia inferiore H 5,5</b> base unit H 76 configured for compact electric oven H 46 1 upper panel H 7,4 1 lower panel H 5,5</p>	L 60	G5540600	157	172			

# SOTTOLAVELLI H 76

SINK BASE UNITS H 76

H 76 P 61

Le basi non sono comprensive di top - N.B.: cerniere ammortizzate di serie The base units do not include the tops - Note: standard blumotion hinges		COD.	NECK ALKOR- CELL KS2	NECK PET KS2			
 <p><b>sottolavello H 76</b> <b>1 anta</b> sink base unit H 76 1 door</p>	L 45	G5060451/2	185	205			
	L 60	G5060601/2	204	228			
 <p><b>sottolavello H 76</b> <b>2 ante</b> sink base unit H 76 2 doors</p>	L 90	G5060900	292	333			
	L 120	G5061200	337	385			
 <p><b>sottolavello H 76</b> <b>1 cestone H 59,7 con scarico salvaspazio</b> sink base unit H 76 1 deep drawer H 59,7 with space-saver drain piping</p>	L 60	G5260600	328	353			
	L 90	G5260900	373	404			
<p><b>NELLE INTERRUZIONI DI GOLA, AGGIUNGERE SEMPRE I RELATIVI TERMINALI</b> ADD. THE ASSOCIATED CLOSURES TO ANY INTERRUPTIONS IN THE FINGER RAIL</p>							



# BASI SOSPESSE con Attaccaglie e Barre Fissaggio a parete

HANGING BASE UNITS with Hangers and Rods for wall mounting

H 37,5 - 51 - 63 P 61

**Le basi non sono comprensive di top - N.B.: cerniere ammortizzate di serie**  
 The base units do not include the tops - Note: standard blumotion hinges





	COD.	NECK ALKOR- CELL KS2	NECK PET KS2				
 <p><b>base H 37,5</b> <b>1 anta H 34,2</b> base unit H 37,5 1 door H 34,2</p>	L 45	G4321451/2	170	186			
	L 60	G4321601/2	182	200			
 <p><b>base H 51</b> <b>1 anta H 47,7</b> base unit H 51 1 door H 47,7</p>	L 45	G4320451/2	186	205			
	L 60	G4320601/2	202	224			
 <p><b>base H 63</b> <b>1 anta H 59,7</b> base unit H 63 1 door H 59,7</p>	L 45	G4322451/2	192	213			
	L 60	G4322601/2	209	233			
 <p><b>base H 37,5</b> <b>2 ante H 34,2</b> base unit H 37,5 2 doors H 34,2</p>	L 90	G4321900	246	277			
	L 120	G4322200	273	310			
 <p><b>base H 51</b> <b>2 ante H 47,7</b> base unit H 51 2 doors H 47,7</p>	L 90	G4320900	275	312			
	L 120	G4321200	326	369			
 <p><b>base H 63</b> <b>2 ante H 59,7</b> base unit H 63 2 doors H 59,7</p>	L 90	G4322900	286	327			

# BASI SOSPESSE con Attaccaglie e Barre Fissaggio a parete

H 37,5 - 51 - 63 P 61

HANGING BASE UNITS with Hangers and Rods for wall mounting





**Le basi non sono comprensive di top - N.B.: cassetti e cestoni ad estrazione totale con blumotion**  
The base units do not include the tops - Note: fully extending drawers and deep drawers with blumotion system

	COD.	NECK ALKOR- CELL KS2	NECK PET KS2				
 <p><b>base H 37,5</b> <b>1 cestone H 34,2</b> base H 37,5 1 deep drawer H 34,2</p>	L 45	G4311450	226	241			
	L 60	G4311600	242	260			
	L 90	G4311900	298	321			
	L 120	G4312200	314	341			
 <p><b>base H 51</b> <b>1 cestone H 47,7</b> base unit H 51 1 deep drawer H 47,7</p>	L 45	G4310450	232	251			
	L 60	G4310600	250	271			
	L 90	G4310900	305	333			
	L 120	G4311200	328	361			
 <p><b>base H 63</b> <b>1 cestone H 59,7</b> <b>1 cassetto interno</b> base unit H 63 1 deep drawer H 59,7 1 internal drawer</p>	L 45	G4312450	334	355			
	L 60	G4312600	370	394			
	L 90	G4312900	430	461			
 <p><b>sottolavello H 51</b> <b>1 cestone sagomato H 47,7</b> <b>scarico salvaspazio</b> sink base unit H 51 1 contoured deep drawer H 47,7 space-saver drain piping</p>	L 90	G5240900	343	371			
 <p><b>sottolavello H 63</b> <b>1 cestone H 59,7</b> <b>scarico salvaspazio</b> sink base unit H 63 1 deep drawer H 59,7 with space-saver drain piping</p>	L 60	G5250600	342	367			
	L 90	G5250900	380	412			

# GOLE PER COLONNE

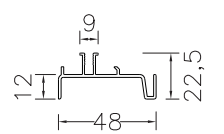
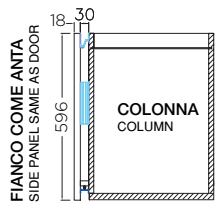
## COLUMNS FINGER RAILS

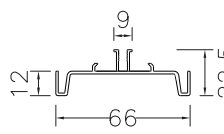

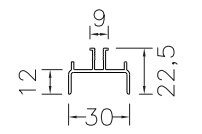
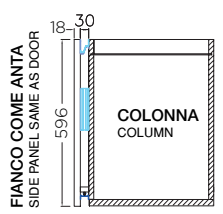

**NELLE COLONNE PER L'APERTURA DELLE ANTE E' OBBLIGATORIO L'INSERIMENTO DELLE GOLE VERTICALI**  
**VERTICAL FINGER RAILS MUST BE FITTED TO COLUMNS WITH OPENING DOORS**

		COD.	NECK ALKOR- CELL KS2	NECK PET KS2
<p><b>mezza gola elle verticale tipo "C"</b>                      elle half finger rail type "C"</p>   <p><b>Sezione gola tipo "C"</b>                      Type "C" finger rail section</p> 	<p><b>gola</b>                      finger rail</p> <p><b>H 96</b></p> <p><b>H 132</b></p> <p><b>H 204</b></p> <p><b>H 228</b></p>			
		G950310	63	63
		G950330	83	83
		G950350	123	123
		G950370	136	136
	<p><b>gola con fianco liscio montato colore come anta</b>                      finger rail mounted on smooth side panel same colour as door</p> <p><b>H 96</b></p> <p><b>H 132</b></p> <p><b>H 204</b></p> <p><b>H 228</b></p>			
		G950319	125	161
		G950339	166	212
		G950359	248	329
		G950379	274	362
<p><b>gola elle verticale intermedia tipo "D"</b>                      elle vertical intermediate finger rail type "D"</p>   <p><b>Sezione gola tipo "D"</b>                      Type "D" finger rail section</p>	<p><b>gola</b>                      finger rail</p> <p><b>H 96</b></p> <p><b>H 132</b></p> <p><b>H 204</b></p> <p><b>H 228</b></p>			
		G950410	63	63
		G950430	83	83
		G950450	123	123
		G950470	136	136
<p><b>gola elle verticale laterale tipo "E"</b>                      elle vertical lateral finger rail type "E"</p>   <p><b>Sezione gola tipo "E"</b>                      Type "E" finger rail section</p> 	<p><b>gola</b>                      finger rail</p> <p><b>H 96</b></p> <p><b>H 132</b></p> <p><b>H 204</b></p> <p><b>H 228</b></p>			
		G950510	63	63
		G950530	83	83
		G950550	123	123
		G950570	136	136
	<p><b>gola con fianco liscio montato colore come anta</b>                      finger rail mounted on smooth side panel same colour as door</p> <p><b>H 96</b></p> <p><b>H 132</b></p> <p><b>H 204</b></p> <p><b>H 228</b></p>			
		G950519	125	161
	G950539	166	212	
	G950559	248	329	
	G950579	274	362	

# COLONNE H 109

P 59,6

COLUMNS H 109







Le colonne non sono comprensive di top - N.B.: cerniere ammortizzate di serie The columns do not include the tops - Note: standard blumotion hinges		COD.	NECK ALKOR- CELL KS2	NECK PET KS2			
 <p><b>fascia tamponamento da 5 a 15</b> filler panel size from 5 to 15</p>							
	<p><b>in nobilitato</b> melamine coated</p> <p><b>come anta con supporto</b> same as door with support</p>	G6000010	50	50			
 <p><b>1 anta</b> 1 door</p>							
	L 30	G6040301/2	176	198			
	L 40	G6040401/2	193	219			
	L 45	G6040451/2	198	226			
	L 60	G6040601/2	225	259			
 <p><b>1 anta vetro</b> 1 glass door</p>							
	telaio alkorcell L 45 alkorcell frame	G6046451/2	219	—			
	L 60	G6046601/2	255	—			
	telaio PET L 45 PET frame	G6046451/2	—	256			
	L 60	G6046601/2	—	301			
 <p><b>*1 anta (cerniere 180°)</b> <b>2 cassetti interni</b> <b>1 cestone interno</b> *1 door (180° hinges) 2 internal drawers 1 internal deep drawer</p>							
	L 45	G6041461/2	393	421			
	L 60	G6041611/2	442	475			
 <p><b>jolly colonna folding</b> <b>L da 10 a 30</b> folding jolly column size from 10 to 30</p>							
	colore come struttura same colour as carcass	E6000900	190	190			
	colore come anta alkorcell same colour as alkorcell door	E6000930	285	—			
	colore come anta PET same colour as PET door	E6000925	—	527			
<p><b>*LE COLONNE CON CASSETTI E GESTONI INTERNI VANNO SEMPRE POSIZIONATE A 5 CM DALLA PARETE LATERALE</b> *COLUMNS WITH INTERNAL DRAWERS AND DEEP DRAWERS SHOULD ALWAYS BE PLACED 5 CM FROM THE SIDE WALL</p>							
<p><b>NELLE COLONNE PER L'APERTURA DELLE ANTE E' OBBLIGATORIO L'INSERIMENTO DELLE GOLE VERTICALI</b> VERTICAL FINGER RAILS MUST BE FITTED TO COLUMNS WITH OPENING DOORS</p>							

NECK  
COLONNE  
COLUMNS

# COLONNE H 145

COLUMNS H 145





P 59,6

Le colonne non sono comprensive di top - N.B.: cerniere ammortizzate di serie The columns units do not include the tops - Note: standard blumotion hinges		COD.	NECK ALKOR- CELL KS2	NECK PET KS2				
 <p><b>fascia tamponamento da 5 a 15</b> filler panel size from 5 to 15</p>								
	<p><b>in nobilitato</b> melamine coated</p>	G6000020	51	51				
	<p><b>come anta con supporto</b> same as door with support</p>	G6000150	95	136				
 <p><b>1 anta</b> 1 door</p>								
	L 30	G6050301/2	209	237				
	L 45	G6050451/2	236	272				
	L 60	G6050601/2	264	307				
 <p><b>1 anta vetro</b> 1 glass door</p>								
	telaio alkorcell L 30 alkorcell frame	G6180301/2	228	—				
	L 45	G6180451/2	265	—				
	L 60	G6180601/2	305	—				
	telaio PET L 30 PET frame	G6180301/2	—	265				
	L 45	G6180451/2	—	312				
L 60	G6180601/2	—	364					
 <p><b>1 anta integrata al gruppo cestelli estraibili in filo orion grau chiusura soft</b> 1 door incorporated into the orion grau wire pull-out basket units soft-closing system</p>								
	L 30	G6150300	480	507				
 <p><b>1 anta gruppo cestelli estraibili in filo orion grau chiusura soft</b> 1 door orion grau wire pull-out basket units soft-closing system</p>								
	L 45	G6150451/2	507	542				
	L 60	G6150601/2	551	593				
 <p><b>1 anta vetro gruppo cestelli estraibili in filo orion grau chiusura soft</b> 1 glass door orion grau wire pull-out basket units soft-closing system</p>								
	telaio alkorcell L 45 alkorcell frame	G6152451/2	541	—				
	L 60	G6152601/2	599	—				
	telaio PET L 45 PET frame	G6152451/2	—	588				
	L 60	G6152601/2	—	659				

# COLONNE H 145

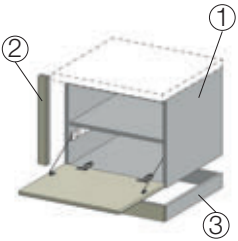
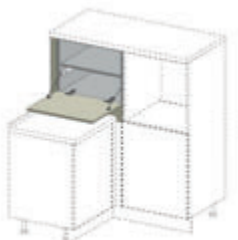
P 59,6







COLUMNS H 145

Le colonne non sono comprensive di top - N.B.: cerniere ammortizzate di serie The columns units do not include the tops - Note: standard blumotion hinges		COD.	NECK ALKOR- CELL KS2	NECK PET KS2				
 <p><b>mobile H 57 L 65</b> <b>apertura a vasistas push-pull</b> <b>con fascia di tamponamento laterale e inferiore</b> <b>in appoggio su base angolo</b> unit H 57 W 65 flap door push-pull opening with lateral and lower filler panel resting on corser base unit</p> <p>verso sx LH version</p>	<p><b>1. elemento H 48 L 60</b> unit H 48 W 60</p> <p><b>2. fascia laterale H 48 L 5</b> lateral filler panel H 48 W 5</p> <p><b>3. fascia inferiore H 9 L 65</b> lower filler panel H 9 W 65</p>	E2520600	258	306				
		E278000A	50	69				
		E2882000	57	77				
 <p><b>Esempio</b> <b>di mobile in appoggio su base angolo</b> <b>con colonna H 132 affiancata</b> <b>Example</b> of unit resting on corser base unit with side by side column H 132</p> <p>verso sx LH version</p>								
 <p><b>angolo 2 ripiani con tirante</b> <b>1 anta (cerniere a pilastro)</b> <b>pannello come anta sp.2,2</b> corner unit 2 shelves with tie beam 1 door (hinges pillar) panel as door Th. 2,2</p> <p>65 45-60</p>		L 110	G6336101/2	426	497			
		L 125	G6336251/2	449	527			
 <p><b>angolo 8 cestelli orion grau estraibili</b> <b>indipendenti all'anta</b> <b>1 anta</b> <b>pannello come anta sp.2,2</b> corner unit 8 pull-out orion grau basket units independent from door 1 door panel as door Th. 2,2</p> <p>65 45-60</p>		L 110	G6338101/2	1.306	1.377			
		L 125	G6338251/2	1.460	1.538			
 <p><b>jolly colonna folding</b> <b>L da 10 a 30</b> folding jolly column size from 10 to 30</p>	<p><b>colore come struttura</b> same colour as carcass</p> <p><b>colore come anta alkorcell</b> same colour as alkorcell door</p> <p><b>colore come anta PET</b> same colour as PET door</p>	E6001000	218	218				
		E6001030	371	—				
		E6001025	—	696				

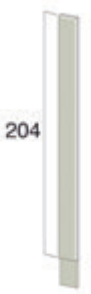
# COLONNE H 217

COLUMNS H 217







P 33,1 - 59,6

N.B.: cerniere ammortizzate di serie Note: standard blumotion hinges		COD.	NECK ALKOR- CELL KS2	NECK PET KS2				
 <p><b>fascia tamponamento da 5 a 15</b> filler panel size from 5 to 15</p>								
	<p><b>in nobilitato</b> melamine coated</p>	G6000050	58	58				
	<p><b>come anta con supporto</b> same as door with support</p>	G6000200	118	176				
 <p><b>2 ante</b> <b>anta superiore H 72</b> <b>anta inferiore H 132</b> 2 doors upper door H 72 lower door H 132</p>								
	L 45 P 33,1	G601345A1/2	314	374				
	L 60 P 33,1	G601360A1/2	360	434				
 <p><b>2 ante</b> <b>anta superiore H 72</b> <b>anta inferiore H 132</b> 2 doors upper door H 72 lower door H 132</p>								
	L 30 P 59,6	G606030A1/2	310	358				
	L 45 P 59,6	G606345A1/2	350	410				
	L 60 P 59,6	G606360A1/2	402	476				
	L 75 P 59,6	G606375A1/2	488	571				
 <p><b>2 ante</b> <b>anta superiore H 132</b> <b>anta inferiore H 72</b> 2 doors upper door H 132 lower door H 72</p>								
	L 45 P 33,1	G601045A1/2	314	374				
	L 60 P 33,1	G601060A1/2	360	434				
 <p><b>2 ante</b> <b>anta vetro H 132</b> <b>anta chiusa H 72</b> 2 doors glass door H 132 full door H 72</p>								
	telaio alkorcell L 30 P 33,1 alkorcell frame	G6202301/2	278	297				
	L 45 P 33,1	G6202451/2	337	360				
	L 60 P 33,1	G6202601/2	384	411				
	telaio PET L 30 P 33,1 PET frame	G6202301/2	314	333				
	L 45 P 33,1	G6202451/2	384	407				
L 60 P 33,1	G6202601/2	443	470					
 <p><b>2 ante vetro</b> <b>anta superiore H 132</b> <b>anta inferiore H 72</b> 2 glass doors upper door H 132 lower door H 72</p>								
	telaio alkorcell L 30 P 33,1 alkorcell frame	G6200311/2	291	—				
	L 45 P 33,1	G6200461/2	351	—				
	L 60 P 33,1	G6200611/2	406	—				
	telaio PET L 30 P 33,1 PET frame	G6200311/2	—	353				
	L 45 P 33,1	G6200461/2	—	429				
L 60 P 33,1	G6200611/2	—	502					

# COLONNE H 217

COLUMNS H 217

P 59,6

<b>N.B.: cerniere ammortizzate di serie</b> Note: standard blumotion hinges		COD.	NECK ALKOR- CELL KS2	NECK PET KS2				
	<b>2 ante</b> <b>anta superiore H 132</b> <b>anta inferiore H 72</b> 2 doors upper door H 132 lower door H 72							
	L 45	G606045A1/2	350	410				
	L 60	G606060A1/2	402	476				
	L 75	G606075A1/2	488	573				
	<b>2 ante</b> <b>anta vetro H 132</b> <b>anta chiusa H 72</b> 2 doors glass door H 132 full door H 72							
	<b>2 ante vetro</b> <b>anta superiore H 132</b> <b>anta inferiore H 72</b> 2 glass doors upper door H 132 lower door H 72							
	<b>portascope</b> <b>2 ante</b> <b>anta superiore H 72</b> <b>anta inferiore H 132</b> broom cabinet 2 doors upper door H 72 lower door H 132							
	L 30	G610030A1/2	310	358				
	L 45	G610045A1/2	343	403				
	<b>portascope con ripiani</b> <b>2 ante</b> <b>anta superiore H 72</b> <b>anta inferiore H 132</b> broom cabinet with shelves 2 doors upper door H 72 lower door H 132							
	L 60	G610060A1/2	427	500				
	<b>1 anta H 204</b> 1 door H 204							
	L 45	G6061451/2	369	428				
L 60	G6061601/2	436	506					









# COLONNE H 217

COLUMNS H 217

P 59,6







**N.B.: cerniere ammortizzate di serie**  
Note: standard blumotion hinges

	COD.	NECK ALKOR- CELL KS2	NECK PET KS2				
 <p><b>portascope</b> <b>1 anta H 204</b> broom cabinet 1 door H 204</p>	L 45	G6100461/2	353	412			
	 <p><b>portascope con ripiani</b> <b>1 anta H 204</b> broom cabinet with shelves 1 door H 204</p>	L 60	G6100611/2	459	529		
 <p><b>anta H 204 integrata al gruppo cestelli estraibili in filo orion grau</b> <b>chiusura soft</b> door H 204 incorporated into the orion grau wire pull-out basket unit soft-closing system</p>		L 30	G6163300	653	701		
	L 45	G6163450	725	782			
 <p><b>1 anta superiore H 72</b> <b>1 anta H 132 integrata al gruppo cestelli estraibili in filo orion grau</b> <b>chiusura soft</b> 1 upper door H 72 1 door H 132 incorporated into the orion grau wire pull-out basket units soft-closing system</p>	L 30	G616030A1/2	578	625			
	 <p><b>1 anta superiore H 72</b> <b>1 anta inferiore H 132</b> <b>gruppo cestelli estraibili in filo orion grau</b> <b>chiusura soft</b> 1 upper door H 72 1 lower door H 132 chromed wire pull-out basket units soft-closing system</p>	L 45	G616045A1/2	621	679		
L 60		G616060A1/2	679	748			
 <p><b>*1 anta superiore H 72 (cerniere 100°)</b> <b>1 anta inferiore H 132 (cerniere 180°)</b> <b>1 cassetto interno</b> <b>3 cestoni interni</b> *1 upper door H 72 (100° hinges) 1 lower door H 132 (180° hinges) 1 internal drawer 3 internal deep drawers</p>	L 45	G608048A1/2	636	693			
	L 60	G608063A1/2	705	773			

# COLONNE H 217

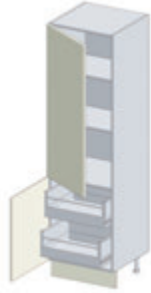
COLUMNS H 217

P 59,6

N.B.: cerniere ammortizzate di serie Note: standard blumotion hinges		COD.	NECK ALKOR- CELL KS2	NECK PET KS2				
 <p><b>*1 anta superiore H 132 (cerniere 100°)</b> <b>1 anta inferiore H 72 (cerniere 180°)</b> <b>4 cassetti interni</b> *1 upper door H 132 (100° hinges) 1 lower door H 72 (180° hinges) 4 internal drawers</p>	L 45	G606545A1/2	580	638				
	L 60	G606560A1/2	677	745				
 <p><b>*1 anta superiore H 132 (cerniere 100°)</b> <b>1 anta inferiore H 72 (cerniere 180°)</b> <b>2 cassetti interni</b> <b>1 cestone interno</b> *1 upper door H 132 (100° hinges) 1 lower door H 72 (180° hinges) 2 internal drawers 1 internal deep drawer</p>	L 45	G606546A1/2	540	598				
	L 60	G606561A1/2	611	679				
 <p><b>*1 anta superiore H 132 (cerniere 100°)</b> <b>1 anta inferiore H 72 (cerniere 180°)</b> <b>2 cestoni interni</b> *1 upper door H 132 (100° hinges) 1 lower door H 72 (180° hinges) 2 internal deep drawers</p>	L 45	G606645A1/2	500	557				
	L 60	G606660A1/2	550	619				
 <p><b>*1 anta vetro superiore H 132</b> <b>1 anta inferiore H 72</b> <b>4 cassetti interni</b> *1 upper glass door H 132 1 lower door H 72 4 internal drawers</p>	telaio alkorcell L 45 alkorcell frame	L 45	G6284451/2	614	637			
		L 60	G6284601/2	718	745			
	telaio PET L 45 PET frame	L 45	G6284451/2	661	684			
		L 60	G6284601/2	777	804			
 <p><b>*1 anta vetro superiore H 132</b> <b>1 anta inferiore H 72</b> <b>2 cassetti interni</b> <b>1 cestone interno</b> *1 upper glass door H 132 1 lower door H 72 2 internal drawers 1 internal deep drawer</p>	telaio alkorcell L 45 alkorcell frame	L 45	G6284461/2	573	596			
		L 60	G6284611/2	659	686			
	telaio PET L 45 PET frame	L 45	G6284461/2	621	644			
		L 60	G6284611/2	718	745			
 <p><b>*1 anta vetro superiore H 132</b> <b>1 anta inferiore H 72</b> <b>2 cestoni interni</b> *1 upper glass door H 132 1 lower door H 72 2 internal deep drawers</p>	telaio alkorcell L 45 alkorcell frame	L 45	G6285451/2	533	556			
		L 60	G6285601/2	603	630			
	telaio PET L 45 PET frame	L 45	G6285451/2	581	603			
		L 60	G6285601/2	663	690			



# COLONNE ANGOLO H 217

CORNER COLUMNS H 217

P 59,6

**N.B.: cerniere ammortizzate di serie**







Note: standard blumotion hinges

	COD.	NECK ALKOR- CELL KS2	NECK PET KS2					
 <p><b>angolo 4 ripiani con tirante</b>  <b>1 anta superiore H 72</b>  <b>1 anta inferiore H 132</b>  <b>(cerniere a pilastro)</b>  <b>pannello come anta sp.2,2</b>                      corner unit 4 shelves with tie beam                      1 upper door H 72                      1 lower door H 132                      (pillar hinges)                      panel as door Th. 2,2</p>	L 110	G6306101/2	614	735				
	L 125	G6306251/2	650	782				
 <p><b>angolo 8 cestelli orion grau estraibili</b>  <b>1 anta superiore H 72</b>  <b>1 anta inferiore H 132</b>  <b>pannello come anta sp.2,2</b>                      corner unit 8 pull-out orion grau basket units                      1 upper door H 72                      1 lower door H 132                      panel as door Th. 2,2</p>	L 110	G6308101/2	1.494	1.615				
	L 125	G6308251/2	1.661	1.793				
 <p><b>jolly colonna folding</b>  <b>L da 15 a 30</b>                      folding jolly column                      size from 15 to 30</p>								
		colore come struttura same colour as carcass	E6002000	285	285			
		colore come anta alkorcell same colour as alkorcell door	E6002030	521	—			
	colore come anta PET same colour as PET door	E6002025	—	1.008				
<p><b>NELLE COLONNE PER L'APERTURA DELLE ANTE                      E' OBBLIGATORIO L'INSERIMENTO DELLE GOLE                      VERTICALI</b>                      VERTICAL FINGER RAILS MUST BE FITTED TO                      COLUMNS WITH OPENING DOORS</p>								
<p><b>*LE COLONNE CON CASSETTI E CESTONI                      INTERNI VANNO SEMPRE POSIZIONATE A 5                      CM DALLA PARETE LATERALE</b>                      *COLUMNS WITH INTERNAL DRAWERS AND DEEP                      DRAWERS SHOULD ALWAYS BE PLACED 5 CM FROM                      THE SIDE WALL</p>								

# COLONNE H 241

COLUMNS H 241

P 33,1 - 59,6







N.B.: cerniere ammortizzate di serie Note: standard blumotion hinges		COD.	NECK ALKOR- CELL KS2	NECK PET KS2				
 <p><b>fascia tamponamento da 5 a 15</b> filler panel size from 5 to 15</p> <p>228</p>								
	<p><b>in nobilitato</b> melamine coated</p>	G6000100	58	58				
	<p><b>come anta con supporto</b> same as door with support</p>	G6000250	118	176				
 <p><b>2 ante</b> <b>anta superiore H 96</b> <b>anta inferiore H 132</b> 2 doors upper door H 96 lower door H 132</p>								
	L 45 P 33,1	G602345A1/2	371	435				
	L 60 P 33,1	G602360A1/2	426	506				
 <p><b>2 ante</b> <b>anta superiore H 96</b> <b>anta inferiore H 132</b> 2 doors upper door H 96 lower door H 132</p>								
	L 30 P 59,6	G607030A1/2	337	389				
	L 45 P 59,6	G607345A1/2	380	444				
	L 60 P 59,6	G607360A1/2	443	522				
 <p><b>2 ante</b> <b>anta superiore H 156</b> <b>anta inferiore H 72</b> 2 doors upper door H 156 lower door H 72</p>								
	L 45 P 33,1	G602045A1/2	371	435				
	L 60 P 33,1	G602060A1/2	422	502				
 <p><b>2 ante</b> <b>anta vetro H 156 (solo telaio PET)</b> <b>(anta unita 132 vetro+24 piena)</b> <b>anta chiusa H 72</b> 2 doors glass door H 156 (only PET frame) <b>(joint glass door 132+full door 24)</b> full door H 72</p>								
	telaio PET L 45 P 33,1 PET frame	G6212451/2	482	505				
 <p><b>2 ante vetro</b> <b>anta superiore H 156 (solo telaio PET)</b> <b>(anta unita 132 vetro+24 piena)</b> <b>anta inferiore H 72</b> 2 glass doors upper door H 156 (only PET frame) <b>(joint glass door 132+full door 24)</b> lower door H 72</p>								
	telaio PET L 45 P 33,1 PET frame	G6210461/2	—	528				

# COLONNE H 241

COLUMNS H 241

P 59,6





**N.B.: cassetti e cestoni ad estrazione totale con blumotion**  
 Note: fully extending drawers and deep drawers with blumotion system

	COD.	NECK ALKOR- CELL KS2	NECK PET KS2				
 <p><b>2 ante</b>  <b>anta superiore H 156</b>  <b>anta inferiore H 72</b>                      2 doors                      upper door H 156                      lower door H 72</p>	L 45	G607045A1/2	380	444			
	L 60	G607060A1/2	438	518			
 <p><b>2 ante</b>  <b>anta vetro H 156 (solo telaio PET)</b>  <b>(anta unita 132 vetro+24 piena)</b>  <b>anta chiusa H 72</b>                      2 doors                      glass door H 156 (only PET frame)                      (joint glass door 132+full door 24)                      full door H 72</p>	telaio PET L 45 PET frame	G6211451/2	491	513			
	 <p><b>2 ante vetro (solo telaio PET)</b>  <b>anta superiore H 156</b>  <b>(anta unita 132 vetro+24 piena)</b>  <b>anta inferiore H 72</b>                      2 glass doors (only PET frame)                      upper door H 156                      (joint glass door 132+full door 24)                      lower door H 72</p>	telaio PET L 45 PET frame	G6210451/2	—	537		
 <p><b>portascope</b>  <b>1 anta superiore H 96</b>  <b>1 anta inferiore H 132</b>                      broom cabinet                      1 upper door H 96                      1 lower door H 132</p>		L 30	G611030A1/2	336	387		
	L 45	G611045A1/2	374	438			
 <p><b>portascope con ripiani</b>  <b>1 anta superiore H 96</b>  <b>1 anta inferiore H 132</b>                      broom cabinet with shelves                      1 upper door H 96                      1 lower door H 132</p>	L 60	G611060A1/2	455	535			
	 <p><b>1 anta superiore H 96</b>  <b>1 anta H 132 integrata al gruppo cestelli</b>  <b>estraibili in filo orion grau</b>  <b>chiusura soft</b>                      1 upper door H 96                      1 door H 132 incorporated into the orion grau wire                      pull-out basket units                      soft-closing system</p>	L 30	G617030A1/2	603	653		

# COLONNE H 241

P 59,6

COLUMNS H 241



<b>N.B.: cassetti e cestoni ad estrazione totale con blumotion</b> Note: fully extending drawers and deep drawers with blumotion system		COD.	NECK ALKOR- CELL KS2	NECK PET KS2			
 <p> <b>1 anta superiore H 96</b>  <b>1 anta inferiore H 132 gruppo cestelli estraibili in filo orion grau</b>  <b>chiusura soft</b>                      1 upper door H 96                      1 lower door H 132 orion grau wire                      pull-out basket units                      soft-closing system                 </p>	L 45	G617045A1/2	650	713			
	L 60	G617060A1/2	717	792			
 <p> <b>*1 anta superiore H 96 (cerniere 100°)</b>  <b>1 anta inferiore H 132 (cerniere 180°)</b>  <b>1 cassetto interno</b>  <b>3 cestoni interni</b>                      *1 upper door H 96 (100° hinges)                      1 lower door H 132 (180° hinges)                      1 internal drawer                      3 internal deep drawers                 </p>	L 45	G608248A1/2	664	726			
	L 60	G608263A1/2	742	816			
 <p> <b>*1 anta superiore H 156 (cerniere 100°)</b>  <b>1 anta inferiore H 72 (cerniere 180°)</b>  <b>4 cassetti interni</b>                      *1 upper door H 156 (100° hinges)                      1 lower door H 72 (180° hinges)                      4 internal drawers                 </p>	L 45	G607545A1/2	609	671			
	L 60	G607560A1/2	705	779			
 <p> <b>*1 anta superiore H 156 (cerniere 100°)</b>  <b>1 anta inferiore H 72 (cerniere 180°)</b>  <b>2 cassetti interni</b>  <b>1 cestone interno</b>                      *1 upper door H 156 (100° hinges)                      1 lower door H 72 (180° hinges)                      2 internal drawers                      1 internal deep drawer                 </p>	L 45	G607546A1/2	569	631			
	L 60	G607561A1/2	644	718			
 <p> <b>*1 anta superiore H 156 (cerniere 100°)</b>  <b>1 anta inferiore H 72 (cerniere 180°)</b>  <b>2 cestoni interni</b>                      *1 upper door H 156 (100° hinges)                      1 lower door H 72 (180° hinges)                      2 internal deep drawers                 </p>	L 45	G607645A1/2	528	590			
	L 60	G607660A1/2	583	658			
<p> <b>*LE COLONNE CON CASSETTI E CESTONI INTERNI VANNO SEMPRE POSIZIONATE A 5 CM DALLA PARETE LATERALE</b>                      *COLUMNS WITH INTERNAL DRAWERS AND DEEP DRAWERS SHOULD ALWAYS BE PLACED 5 CM FROM THE SIDE WALL                 </p>							

# COLONNE H 241

COLUMNS H 241

P 59,6

**N.B.: cassetti e cestoni ad estrazione totale con blumotion**  
 Note: fully extending drawers and deep drawers with blumotion system

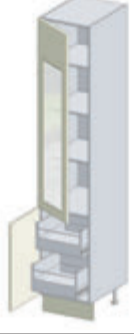
	COD.	NECK ALKOR- CELL KS2	NECK PET KS2				
 <p><b>*1 anta vetro superiore H 156 (solo telaio PET)</b>  <b>(anta unita 132 vetro+24 piena)</b>  <b>1 anta inferiore H 72</b>  <b>4 cassetti interni</b>                      *1 upper glass door H 156 (only PET frame)                      (joint glass door 132+full door 24)                      1 lower door H 72                      4 internal drawers</p>							
	telaio PET L 45 PET frame	G6294451/2	734	757			
 <p><b>*1 anta vetro superiore H 156 (solo telaio PET)</b>  <b>(anta unita 132 vetro+24 piena)</b>  <b>1 anta inferiore H 72</b>  <b>2 cassetti interni</b>  <b>1 cestone interno</b>                      *1 upper glass door H 156 (only PET frame)                      (joint glass door 132+full door 24)                      1 lower door H 72                      2 internal drawers                      1 internal deep drawer</p>							
	telaio PET L 45 PET frame	G6294461/2	694	717			
 <p><b>*1 anta vetro superiore H 156 (solo telaio PET)</b>  <b>(anta unita 132 vetro+24 piena)</b>  <b>1 anta inferiore H 72</b>  <b>2 cestoni interni</b>                      *1 upper glass door H 156 (only PET frame)                      (joint glass door 132+full door 24)                      1 lower door H 72                      2 internal deep drawers</p>							
	telaio PET L 45 PET frame	G6295451/2	654	677			
<p><b>NELLE COLONNE PER L'APERTURA DELLE ANTE                      E' OBBLIGATORIO L'INSERIMENTO DELLE GOLE                      VERTICALI</b>                      VERTICAL FINGER RAILS MUST BE FITTED TO                      COLUMNS WITH OPENING DOORS</p>							

# COLONNE ANGOLO H 241

P 59,6

CORNER COLUMNS H 241

**N.B.: cerniere ammortizzate di serie**

Note: standard blumotion hinges



**angolo 5 ripiani con tirante**  
**1 anta superiore H 96**  
**1 anta inferiore H 132**  
**(cerniere a pilastro)**  
**pannello come anta sp. 2,2**  
 corner unit 5 shelves with tie beam  
 1 upper door H 96  
 1 lower door H 132  
 (pillar hinges)  
 panel as door Th. 2,2

L 110  
L 125

COD.	NECK ALKOR- CELL KS2	NECK PET KS2				
G6316101/2	671	803				
G6316251/2	717	861				
G6318101/2	1.551	1.683				
G6318251/2	1.728	1.872				
E6003000	307	307				
E6003030	630	—				
E6003025	—	1.179				



**angolo 8 cestelli orion grau estraibili**  
**indipendenti all'anta**  
**1 anta superiore H 96**  
**1 anta inferiore H 132**  
**pannello come anta sp. 2,2**  
 corner unit 8 pull-out orion grau basket  
 units independent from door  
 1 upper door H 96  
 1 lower door H 132  
 panel as door Th. 2,2

L 110  
L 125



**jolly colonna folding**  
**L da 15 a 30**  
 folding jolly column  
 size from 15 to 30

**colore come struttura**  
 same colour as carcass  
**colore come anta alkorcell**  
 same colour as alkorcell door  
**colore come anta PET**  
 same colour as PET door

**NELLE COLONNE PER L'APERTURA DELLE ANTE**  
**E' OBBLIGATORIO L'INSERIMENTO DELLE GOLE**  
**VERTICALI**  
**VERTICAL FINGER RAILS MUST BE FITTED TO**  
**COLUMNS WITH OPENING DOORS**







# COLONNE PER FORNO H 109 - 128

P 59,6

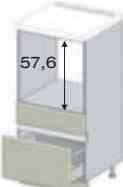
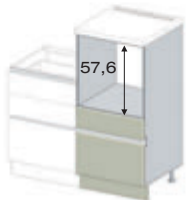
OVEN COLUMNS H 109 - 128

**Le colonne non sono comprensive di top - N.B.: cassetti e cestoni ad estrazione totale con blumotion**  
The columns do not include the tops - Note: fully extending drawers and deep drawers with blumotion system

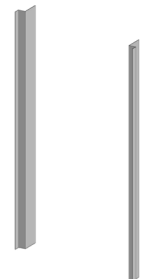

	COD.	NECK ALKOR- CELL KS2	NECK PET KS2			
<p><b>colonna H 109 per forno</b> <b>1 cestone chiuso H 35,7</b> oven column H 109 1 full deep drawer H 35,7</p> 						
<b>L 60</b>	G6501600	258	277			
<p><b>colonna H 128 per forno</b> <b>con gola orizzontale</b> <b>1 cassetto H 16,9</b> <b>1 cestone H 34,2</b> oven column H 128 with horizontal finger rail 1 drawer H 16,9 1 deep drawer H 34,2</p> <p><b>N.B.: colonna da utilizzare con basi cestoni</b> Note: column to use with deep drawer base units</p>  						
<b>L 60</b>	G6510600	362	391			
<p><b>top H 1,8 come anta</b> <b>P 59,7 per colonne</b> worktop H 1,8 same as door D 59,7 for columns</p> 						
	<b>alkorcell al ml</b> alkorcell per lm	TLM186A	83	—		
	<b>PET al ml</b> PET per lm	TLM186P	—	127		
	<b>mag.griglia di areazione cad.</b> surcharge for ventilation grille each	T9FGA	30	30		
<p><b>profilo in acciaio a "L" per rifinire il ripiano del forno e microonde</b> L-shaped steel finishing profile for shelf of oven and microwave</p>  						
<b>L 60</b>						
	<b>inox</b> stainless steel	08660100	9	9		
	<b>nero</b> black	08660101	9	9		
	<b>bianco</b> white	08660102	9	9		
<b>L 90</b>						
	<b>inox</b> stainless steel	08660105	12	12		
<p><b>kit protezione fianchi per forno</b> protection kit sides for oven</p>  						
<b>coppia</b> couple	08630095	16	16			

# COLONNE PER FORNO H 145

P 59,6

OVEN COLUMNS H 145

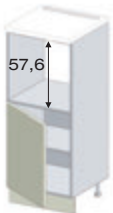
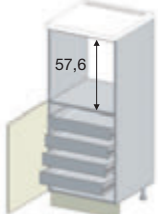
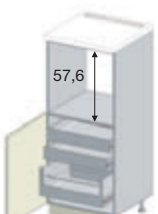
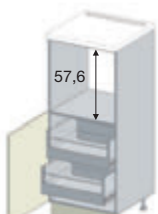
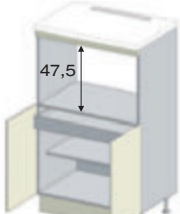
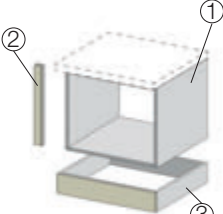
**Le colonne non sono comprensive di top - N.B.: cerniere ammortizzate di serie**  
The columns do not include the tops - Note: standard blumotion hinges



	COD.	NECK ALKOR- CELL KS2	NECK PET KS2				
 <p><b>colonna H 145 per forno</b> <b>1 anta H 72 apertura push-pull</b> oven column H 145 1 door H 72 push-pull opening</p>	L 60	G6520601/2	250	277			
	L 75	G6520751/2	297	328			
 <p><b>colonna H 145 per forno</b> <b>1 anta H 72 apertura push-pull (cerniere 180°)</b> <b>4 cassetti interni</b> <b>posizionare a 5 cm dalla parete laterale</b> oven column H 145 1 door H 72 push-pull opening (180°hinges) 4 internal drawers place at 5 cm from the side wall</p>	L 60	G6521611/2	536	563			
 <p><b>colonna H 145 per forno</b> <b>1 anta H 72 apertura push-pull (cerniere 180°)</b> <b>2 cassetti interni</b> <b>1 cestone interno</b> <b>posizionare a 5 cm dalla parete laterale</b> oven column H 145 1 door H 72 push-pull opening (180°hinges) 2 internal drawers 1 internal deep drawer place at 5 cm from the side wall</p>	L 60	G6521621/2	475	503			
 <p><b>colonna H 145 per forno</b> <b>1 anta H 72 apertura push-pull (cerniere 180°)</b> <b>2 cestoni interni</b> <b>posizionare a 5 cm dalla parete laterale</b> oven column H 145 1 door H 72 push-pull opening (180°hinges) 2 internal deep drawers place at 5 cm from the side wall</p>	L 60	G6521631/2	418	445			
 <p><b>colonna H 145 per forno per maxiforno H 48</b> <b>1 cassetto interno</b> <b>2 ante H 72 apertura push-pull (cerniere 180°)</b> <b>posizionare a 5 cm dalla parete laterale</b> oven column H 145 for maxi-oven H 48 1 internal drawer 2 doors H 72 push-pull opening (180°hinges) place at 5 cm from the side wall</p>	L 90	G6521950	502	550			
 <p><b>mobile H 57 L 65 per micro</b> <b>con fascia di tamponamento laterale e inferiore</b> <b>in appoggio su base angolo</b> unit H 57 W 65 flap door push-pull opening with lateral and lower filler panel resting on corser base unit</p> <p>verso sx LH version</p>							
		E2521600	119	129			
		E278000B	50	69			
		E2882100	57	77			
 <p><b>Esempio</b> <b>di mobile per micro in appoggio su base angolo</b> <b>con colonna H 132 affiancata</b> <b>Example</b> of micro unit resting on corser base unit with side by side column H 132</p> <p>verso sx LH version</p>							

# COLONNE PER FORNO H 217

OVEN COLUMNS H 217

P 59,6

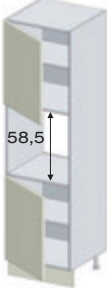
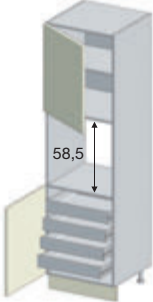
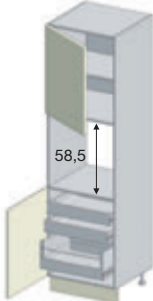
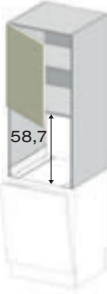



**N.B.: cassetti e cestoni ad estrazione totale con blumotion**  
 Note: fully extending drawers and deep drawers with blumotion system

	COD.	NECK ALKOR- CELL KS2	NECK PET KS2				
 <p><b>colonna per forno apertura push-pull 1 anta superiore H 72 1 anta inferiore H 72</b> oven column push-pull opening 1 upper door H 72 1 lower door H 72</p>	L 60	G653060A1/2	372	427			
	L 75	G653075A1/2	451	514			
 <p><b>colonna per forno apertura push-pull 1 anta superiore H 72 1 anta inferiore H 72 (cerniere 180°) 4 cassetti interni</b> <b>posizionare a 5 cm dalla parete laterale</b> oven column push-pull opening 1 upper door H 72 1 lower door H 72 (180° hinges) 4 internal drawers <b>place at 5 cm from the side wall</b></p>	L 60	G653161A1/2	682	736			
	L 60	G653162A1/2	621	675			
 <p><b>colonna per forno apertura push-pull 1 anta superiore H 72 1 anta inferiore H 72 (cerniere 180°) 2 cassetti interni 1 cestone interno</b> <b>posizionare a 5 cm dalla parete laterale</b> oven column push-pull opening 1 upper door H 72 1 lower door H 72 (180° hinges) 2 internal drawers 1 internal deep drawer <b>place at 5 cm from the side wall</b></p>	L 60	G653163A1/2	560	614			
	L 60	G6576601/2	285	313			
 <p><b>colonna forno sospesa H 132 per lavastoviglie 1 anta H 72</b> <b>N.B.: inserire base lavastoviglie L 60 della versione Bridge</b> hanging oven column H 132 for dishwasher 1 door H 72 <b>Note: do insert dishwasher base unit for the Bridge version</b></p>	L 60	G6576601/2	285	313			
 <p><b>fianco per colonna sospesa a fine composizione</b> side panel for hanging column placed at the end of the composition</p>							
		H 217x59,6x1,8 zoccolo H 13					
		alkorcell come anta alkorcell same as door	T94380	150	—		
	PET come anta PET same as door	T94380	—	224			

# COLONNE PER FORNO H 217

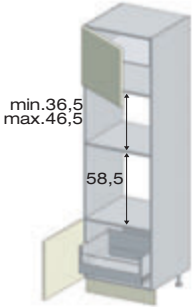
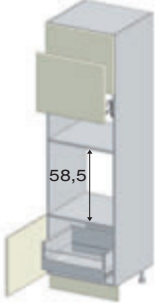
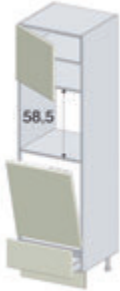
P 59,6

OVEN COLUMNS H 217

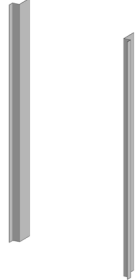

N.B.: cassetti e cestoni ad estrazione totale con blumotion Note: fully extending drawers and deep drawers with blumotion system		COD.	NECK ALKOR- CELL KS2	NECK PET KS2				
 <p><b>colonna per forno e micro apertura push-pull</b>  <b>1 anta superiore H 48</b>  <b>1 anta inferiore H 48 (cerniere 180°)</b>  <b>1 cestone interno</b>  <b>vano micro da H 36,5 a 46,5</b>  <b>posizionare a 5 cm dalla parete laterale</b>                      oven and microwave column push-pull opening                      1 upper door H 48                      1 lower door H 48 (180° hinges)                      1 internal deep drawer                      microwave compartment H 36,5 to 46,5  <b>place at 5 cm from the side wall</b></p>	L 60	G6551611/2	511	551				
	 <p><b>colonna per forno - 1 anta superiore H 48</b>  <b>1 anta H 48 sollevamento verticale</b>  <b>1 anta inferiore H 48 (cerniere 180°)</b>  <b>1 cestone interno</b>  <b>posizionare a 5 cm dalla parete laterale</b>  <b>N.B.: in base alla composizione è obbligatorio</b>  <b>inserire nella colonna con anta sollevamento</b>  <b>verticale, gola tipo "D" o "C" per permettere</b>  <b>l'apertura della stessa</b>                      oven column                      1 upper door H 48                      1 door H 48 vertical opening                      1 lower door H 48 (180° hinges) - 1 internal deep drawer  <b>place at 5 cm from the side wall</b>                      Note: based on the composition, a type "D" or "C" finger rail must be fitted to the column with vertical opening door to allow it to open</p>	L 60	G6554601/2	696	760			
 <p><b>colonna per forno e lavastoviglie</b>  <b>Electrolux KESC 5300L - AEG FSE63307P</b>  <b>1 anta superiore H 48</b>  <b>1 anta lavastoviglie H 72</b>  <b>1 cassetto H 24</b>  <b>N.B.: in base alla composizione è obbligatorio</b>  <b>inserire nella colonna con lavastoviglie, gola tipo "D"</b>  <b>o "C" per permettere l'apertura della stessa</b>                      column for oven and Electrolux KESC 5300L                      AEG FSE 63307P dishwasher                      1 upper door H 48                      1 dishwasher door H 72                      1 drawer H 24                      Note: based on the composition, a type "D" or "C" finger rail must be fitted to the column with dishwasher to allow it to open</p>	L 60	G6573601/2	455	519				
	 <p><b>profilo in acciaio a "L" per rifinire il ripiano del</b>  <b>forno e microonde</b>                      L-shaped steel finishing profile for shelf of oven and microwave</p> 	L 60						
			<b>inox</b> stainless steel	08660100	9	9		
			<b>nero</b> black	08660101	9	9		
			<b>bianco</b> white	08660102	9	9		
 <p><b>kit protezione fianchi per forno</b>                      protection kit sides for oven</p> 								
			<b>coppia</b> couple	08630095	16	16		

# COLONNE PER FORNO H 241

P 59,6

OVEN COLUMNS H 241

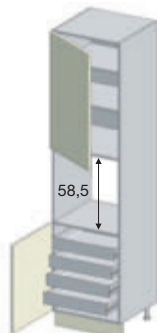
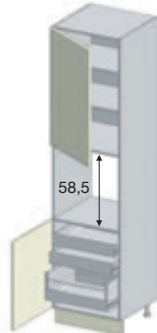
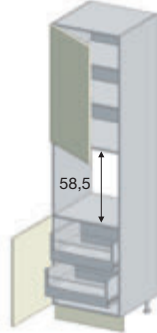
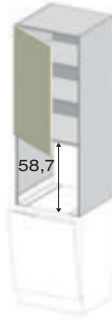
**N.B.: cassetti e cestoni ad estrazione totale con blumotion**  
 Note: fully extending drawers and deep drawers with blumotion system

	COD.	NECK ALKOR- CELL KS2	NECK PET KS2				
 <p><b>colonna per forno apertura push-pull 1 anta superiore H 96 1 anta inferiore H 72</b> oven column push-pull opening 1 upper door H 96 1 lower door H 72</p>	L 60	G654060A1/2	412	472			
 <p><b>colonna per forno apertura push-pull 1 anta superiore H 96 1 anta inferiore H 72 (cerniere 180°) 4 cassetti interni</b> <b>posizionare a 5 cm dalla parete laterale</b> oven column push-pull opening 1 upper door H 96 1 lower door H 72 (180° hinges) 4 internal drawers <b>place at 5 cm from the side wall</b></p>	L 60	G654161A1/2	721	781			
 <p><b>colonna per forno apertura push-pull 1 anta superiore H 96 1 anta inferiore H 72 (cerniere 180°) 2 cassetti interni 1 cestone interno</b> <b>posizionare a 5 cm dalla parete laterale</b> oven column push-pull opening 1 upper door H 96 1 lower door H 72 (180° hinges) 2 internal drawers 1 internal deep drawer <b>place at 5 cm from the side wall</b></p>	L 60	G654162A1/2	660	720			
 <p><b>colonna per forno apertura push-pull 1 anta superiore H 96 1 anta inferiore H 72 (cerniere 180°) 2 cestoni interni</b> <b>posizionare a 5 cm dalla parete laterale</b> oven column push-pull opening 1 upper door H 96 1 lower door H 72 (180° hinges) 2 internal deep drawers <b>place at 5 cm from the side wall</b></p>	L 60	G654163A1/2	599	659			
 <p><b>colonna forno sospesa H 156 per lavastoviglie 1 anta H 96</b> <b>N.B.: inserire base lavastoviglie L 60 della versione Bridge</b> hanging oven column H 156 for dishwasher 1 door H 96 <b>Note: do insert dishwasher base unit for the Bridge version</b></p>	L 60	G6577601/2	329	362			
 <p><b>fianco per colonna sospesa a fine composizione</b> side panel for hanging column placed at the end of the composition</p>							
		H 241x59,6x1,8 zoccolo H 13					
		alkorcell come anta alkorcell same as door	T94386	162	—		
		PET come anta PET same as door	T94386	—	243		

# COLONNE PER FORNO H 241

P 59,6

OVEN COLUMNS H 241

**N.B.: cassetti e cestoni ad estrazione totale con blumotion**  
 Note: fully extending drawers and deep drawers with blumotion system

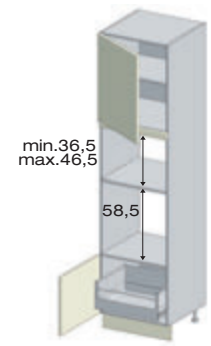

**colonna per forno e micro apertura push-pull**  
**1 anta superiore H 72**  
**1 anta inferiore H 48 (cerniere 180°)**  
**1 cestone interno**  
**vano micro da H 36,5 a 46,5**  
**posizionare a 5 cm dalla parete laterale**  
 oven and microwave column push-pull opening  
 1 upper door H 72  
 1 lower door H 48 (180° hinges)  
 1 internal deep drawer  
 microwave compartment H 36,5 to 46,5  
**place at 5 cm from the side wall**

L 60

COD.	NECK ALKOR-CELL KS2	NECK PET KS2				
G6561611/2	534	580				

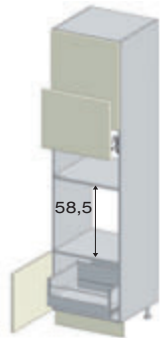

**colonna per forno - 1 anta superiore H 72**  
**1 anta H 48 sollevamento verticale**  
**1 anta inferiore H 48 (cerniere 180°)**  
**1 cestone interno**  
**posizionare a 5 cm dalla parete laterale**  
**N.B.: in base alla composizione è obbligatorio inserire nella colonna con anta sollevamento verticale, gola tipo "D" per permettere l'apertura della stessa**  
 oven column - 1 upper door H 72  
 1 door H 48 vertical opening  
 1 lower door H 48 (180° hinges)  
 1 internal deep drawer  
**place at 5 cm from the side wall**  
**Note: based on the composition, a type "D" finger rail must be fitted to the column with vertical opening door to allow it to open**

L 60

G6564601/2	705	775				
------------	-----	-----	--	--	--	--

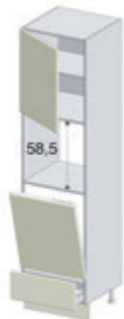

**colonna per forno e lavastoviglie**  
**Electrolux KESC 5300L - AEG FSE63307P**  
**1 anta superiore H 72**  
**1 anta lavastoviglie H 72**  
**1 cassetto H 24**  
**N.B.: in base alla composizione è obbligatorio inserire nella colonna con lavastoviglie, gola tipo "D" per permettere l'apertura della stessa**  
 column for oven and Electrolux KESC 5300L  
 AEG FSE 63307P dishwasher  
 1 upper door H 72  
 1 dishwasher door H 72  
 1 drawer H 24  
**Note: based on the composition, a type "D" finger rail must be fitted to the column with dishwasher to allow it to open**

L 60

G6575601/2	489	559				
------------	-----	-----	--	--	--	--



**profilo in acciaio a "L" per rifinire il ripiano del forno e microonde**  
 L-shaped steel finishing profile for shelf of oven and microwave



L 60  
 inox stainless steel  
 nero black  
 bianco white

08660100	9	9				
08660101	9	9				
08660102	9	9				



**kit protezione fianchi per forno**  
 protection kit sides for oven



coppia couple

08630095	16	16				
----------	----	----	--	--	--	--

# COLONNE PER FRIGO H 145 - 217

P 59,6

FRIDGE COLUMNS H 145 - 217

**Le colonne non sono comprensive di top**  
The columns do not include the tops

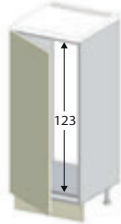
	COD.	NECK ALKOR- CELL KS2	NECK PET KS2				
 <p><b>colonna H 145 per frigo 215 monoporta</b> column H 145 for single-door fridge 215</p>	L 60	G6452151/2	285	327			
 <p><b>colonna H 217 per frigo 215 monoporta</b> <b>1 anta superiore H 72</b> <b>1 anta inferiore H 132</b> column H 217 for 215 single-door fridge 1 upper door H 72 lower door H 132</p>	L 60	G646215A1/2	372	442			
 <p><b>colonna H 217 per frigo-freezer 230</b> <b>1 anta superiore H 84</b> <b>1 anta inferiore H 120</b> column H 217 for 230 fridge-freezer 1 upper door H 84 1 lower door H 120</p>	L 60	G646231A1/2	372	442			
 <p><b>colonna H 217 per frigo-freezer 280</b> <b>1 anta superiore H 84</b> <b>1 anta inferiore H 120</b> column H 217 for 280 fridge-freezer 1 upper door H 84 1 lower door H 120</p>	L 60	G646286A1/2	372	442			
 <p><b>colonna H 217 per frigo-congelatore 315</b> <b>1 anta superiore H 132</b> <b>1 anta inferiore H 72</b> column H 217 for 315 fridge-freezer 1 upper door H 132 1 lower door H 72</p>	L 60	G646315A1/2	372	442			
<p><b>NELLE COLONNE PER L'APERTURA DELLE ANTE E' OBBLIGATORIO L'INSERIMENTO DELLE GOLE VERTICALI</b> VERTICAL FINGER RAILS MUST BE FITTED TO COLUMNS WITH OPENING DOORS</p>							

# COLONNE PER FRIGO H 217

P 59,6

FRIDGE COLUMNS H 217

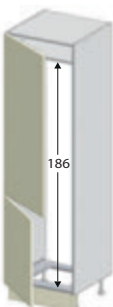
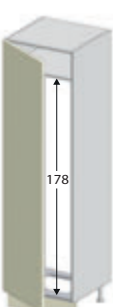
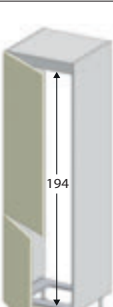
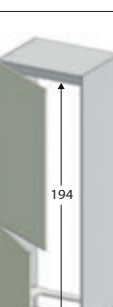
	COD.	NECK ALKOR- CELL KS2	NECK PET KS2				
 <p><b>colonna H 217 per frigo-congelatore 315</b>  <b>3 ante</b>  <b>anta superiore H 24</b>  <b>anta centrale H 108</b>  <b>anta inferiore H 72</b>                      column H 217 for 315 fridge-freezer                      3 doors                      upper door H 24                      central door H 108                      lower door H 72</p>	L 60	G6463161/2	408	488			
	 <p><b>colonna H 217 per frigo-congelatore 330</b>  <b>1 anta superiore H 132</b>  <b>1 anta inferiore H 72</b>                      column H 217 for 330 fridge-freezer                      1 upper door H 132                      1 lower door H 72</p>	L 60	G646330A1/2	372	442		
 <p><b>colonna H 217 per frigo-freezer 300 monoporta</b>  <b>1 anta H 204</b>                      column H 217 for 300 single-door fridge-freezer                      1 door H 204</p>		L 60	G6463001/2	372	442		
	 <p><b>colonna H 217 per frigo-congelatore 350</b>  <b>1 anta superiore H 132</b>  <b>1 anta inferiore H 72</b>                      column H 217 for 350 fridge-freezer                      1 upper door H 132                      1 lower door H 72</p>	L 60	G646350A1/2	372	442		
 <p><b>colonna H 217 per frigo-congelatore 400</b>  <b>1 anta superiore H 132</b>  <b>1 anta inferiore H 72</b>                      column H 217 for 400 fridge-freezer                      1 upper door H 132                      1 lower door H 72</p>		L 75	G646400A1/2	455	536		
	<p><b>NELLE COLONNE PER L'APERTURA DELLE ANTE                      E' OBBLIGATORIO L'INSERIMENTO DELLE GOLE                      VERTICALI</b>                      VERTICAL FINGER RAILS MUST BE FITTED TO                      COLUMNS WITH OPENING DOORS</p>						



# COLONNE PER FRIGO H 241

FRIDGE COLUMNS H 241



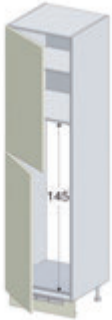
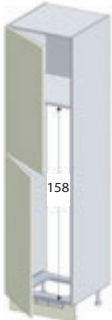

P 59,6





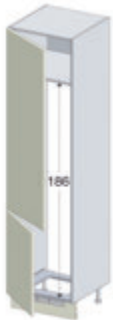

	COD.	NECK ALKOR- CELL KS2	NECK PET KS2				
 <p><b>colonna H 241 per frigo 215 monoporta</b>  <b>1 anta superiore H 96</b>  <b>1 anta inferiore H 132</b>                      column H 241 for 215 single-door fridge                      1 upper door H 96                      1 lower door H 132</p>	L 60	G647215A1/2	394	470			
 <p><b>colonna H 241 per frigo-freezer 230</b>  <b>1 anta superiore H 108</b>  <b>1 anta inferiore H 120</b>                      column H 241 for 230 fridge-freezer                      1 upper door H 108                      1 lower door H 120</p>	L 60	G647231A1/2	394	470			
 <p><b>colonna H 241 per frigo-freezer 280</b>  <b>1 anta superiore H 108</b>  <b>1 anta inferiore H 120</b>                      column H 241 for 280 fridge-freezer                      1 upper door H 108                      1 lower door H 120</p>	L 60	G647286A1/2	394	470			
 <p><b>colonna H 241 per frigo-congelatore 315</b>  <b>1 anta superiore H 156</b>  <b>1 anta inferiore H 72</b>                      column H 241 for 315 fridge-freezer                      1 upper door H 156                      1 lower door H 72</p>	L 60	G647315A1/2	394	470			
 <p><b>colonna H 241 per frigo-congelatore 315</b>  <b>3 ante</b>  <b>anta superiore H 48</b>  <b>anta centrale H 108</b>  <b>anta inferiore H 72</b>                      column H 241 for 315 fridge-freezer                      3 doors                      upper door H 48                      central door H 108                      lower door H 72</p>	L 60	G6473161/2	434	518			
<p><b>NELLE COLONNE PER L'APERTURA DELLE ANTE E' OBBLIGATORIO L'INSERIMENTO DELLE GOLE VERTICALI</b>                      VERTICAL FINGER RAILS MUST BE FITTED TO COLUMNS WITH OPENING DOORS</p>							

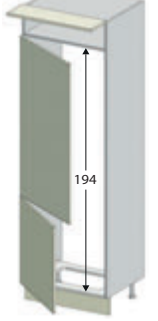





# COLONNE PER FRIGO H 241





P 59,6

FRIDGE COLUMNS H 241

	COD.	NECK ALKOR- CELL KS2	NECK PET KS2				
 <p><b>colonna H 241 per frigo-congelatore 330</b>  <b>1 anta superiore H 156</b>  <b>1 anta inferiore H 72</b>                      column H 241 for 330 fridge-freezer                      1 upper door H 156                      1 lower door H 72</p>	L 60	G647330A1/2	394	470			
	 <p><b>colonna H 241 per frigo-congelatore 330</b>  <b>1 anta superiore H 36</b>  <b>1 anta centrale H 120</b>  <b>1 anta inferiore H 72</b>                      column H 241 for 330 fridge-freezer                      1 upper door H 36                      1 central door H 120                      1 lower door H 72</p>	L 60	G6473361/2	434	518		
 <p><b>colonna H 241 per frigo-congelatore 300</b>  <b>monoporta</b>  <b>1 anta superiore H 48</b>  <b>1 anta inferiore H 180</b>                      column H 241 for 300 single-door fridge-freezer                      1 upper door H 48                      1 lower door H 180</p>		L 60	G6473001/2	434	518		
	 <p><b>colonna H 241 per frigo-congelatore 350</b>  <b>1 anta superiore H 156</b>  <b>1 anta inferiore H 72</b>                      column H 241 for 350 fridge-freezer                      1 upper door H 156                      1 lower door H 72</p>	L 60	G647350A1/2	394	470		
 <p><b>colonna H 241 per frigo-congelatore 400</b>  <b>1 anta superiore a ribalta H 24 TIP-ON</b>  <b>1 anta centrale H 132</b>  <b>1 anta inferiore H 72</b>                      column H 241 for 400 fridge-freezer                      1 upper flap door H 24 TIP-ON opening                      1 central door H 132                      1 lower door H 72</p>		L 75	G6474101/2	608	707		
	<p><b>NELLE COLONNE PER L'APERTURA DELLE ANTE                      E' OBBLIGATORIO L'INSERIMENTO DELLE GOLE                      VERTICALI</b>                      VERTICAL FINGER RAILS MUST BE FITTED TO                      COLUMNS WITH OPENING DOORS</p>						

<b>Le basi non sono comprensive di top - N.B.: cerniere ammortizzate di serie</b> The base units do not include the tops - Note: standard blumotion hinges		COD.	BRIDGE ALKOR- CELL KS1	BRIDGE PET KS1				
 <p><b>fascia tamponamento</b> filler panel</p>	<p><b>L da 3 a 15</b> size from 3 to 15</p>	E4800000	63	73				
 <p><b>jolly base folding</b> <b>L da 10 a 30</b> folding jolly base unit size from 10 to 30</p>	<p><b>colore come struttura</b> same colour as carcass <b>colore come anta alkorcell</b> same colour as alkorcell door <b>colore come anta PET</b> same colour as PET door</p>	E4700000	130	130				
		E4700030	246	—				
		E4700025	—	425				
 <p><b>1 anta</b> 1 door</p>	<p><b>L 15</b> <b>L 30</b> <b>L 40</b> <b>L 45</b> <b>L 60</b> <b>L 65</b></p>	E4010151/2	121	139				
		E4010301/2	140	158				
		E4010401/2	147	175				
		E4010451/2	156	179				
		E4010601/2	175	202				
		E4010651/2	183	211				
 <p><b>2 ante</b> 2 doors</p>	<p><b>L 60</b> <b>L 80</b> <b>L 90</b></p>	E4010600	222	260				
		E4010800	241	298				
		E4010900	262	307				
 <p><b>cestello estraibile</b> <b>chiusura soft</b> pull-out basket unit soft-closing system</p>	<p><b>L 15</b> <b>L 30</b> <b>L 45</b></p>	E4150150	155	173				
		E4150300	211	228				
		E4150450	227	250				
 <p><b>4 cassetti H 18</b> 4 drawers H 18</p>	<p><b>L 30</b> <b>L 40</b> <b>L 45</b> <b>L 60</b></p>	E4101300	383	418				
		E4101400	385	423				
		E4101450	398	437				
		E4101600	437	474				
 <p><b>portaposate in plastica per cassetti</b> plastic cutlery tray for drawers</p>	<p><b>L 30</b> <b>L 40</b> <b>L 45</b> <b>L 60</b> <b>divisori regolabili L 90</b> adjustable separators <b>divisori regolabili L 120</b> adjustable separators</p>	08700030X	10	10				
		08700040X	10	10				
		08700050X	10	10				
		08700060X	11	11				
		08700070X	32	32				
		08700075X	40	40				

<b>Le basi non sono comprensive di top - N.B.: cassetti e cestoni ad estrazione totale con blumotion</b> The base units do not include the tops - Note: fully extending drawers and deep drawers with blumotion system		COD.	BRIDGE ALKOR- CELL KS1	BRIDGE PET KS1				
 <p><b>2 cassetti H 18</b> <b>1 cestone H 36</b> 2 drawers H 18 1 deep drawer H 36</p>	L 45	E4131450	349	385				
	L 60	E4131600	381	419				
	L 90	E4131900	472	522				
	L 120	E4132200	519	578				
 <p><b>2 cassetti H 18</b> <b>1 cestone vetro H 36</b> 2 drawers H 18 1 glass deep drawer H 36</p>	telaio alkorcell L 45 alkorcell frame	L 45	E4141450	364	384			
		L 60	E4141600	395	414			
		L 90	E4141900	488	514			
	telaio PET L 45 PET frame	L 45	E4141450	388	408			
		L 60	E4141600	416	435			
		L 90	E4141900	514	540			
 <p><b>4 cassetti H 18</b> <b>1 cestone H 36</b> 4 drawers H 18 1 deep drawer H 36</p>	L 90	E4300900	632	708				
 <p><b>4 cassetti H 18</b> <b>1 cestone vetro H 36</b> 4 drawers H 18 1 glass deep drawer H 36</p>	telaio alkorcell L 90 alkorcell frame	L 90	E4301900	662	701			
	telaio PET L 90 PET frame	L 90	E4301900	688	727			
 <p><b>2 cestoni H 36</b> 2 deep drawers H 36</p>	L 45	E4171450	298	330				
	L 60	E4171600	324	361				
	L 90	E4171900	418	465				
	L 120	E4172200	431	487				
 <p><b>2 cestoni</b> <b>1 frontale chiuso H 36</b> <b>1 frontale vetro H 36</b> 2 deep drawers 1 full front H 36 1 glass front H 36</p>	telaio alkorcell L 45 alkorcell frame	L 45	E4181450	313	329			
		L 60	E4181600	338	356			
		L 90	E4181900	435	458			
	telaio PET L 45 PET frame	L 45	E4181450	337	353			
		L 60	E4181600	359	377			
		L 90	E4181900	460	483			
 <p><b>2 cestoni vetro H 36</b> 2 glass deep drawers H 36</p>	telaio alkorcell L 45 alkorcell frame	L 45	E4191450	329	—			
		L 60	E4191600	352	—			
		L 90	E4191900	451	—			
	telaio PET L 45 PET frame	L 45	E4191450	—	377			
		L 60	E4191600	—	393			
		L 90	E4191900	—	501			

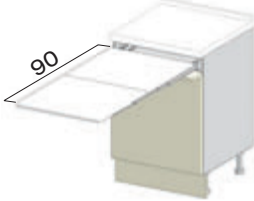
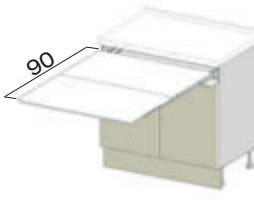
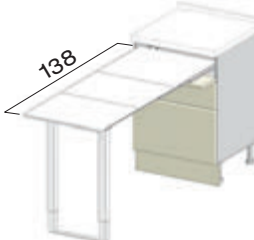
Le basi non sono comprensive di top - N.B.: cassetti e cestoni ad estrazione totale con blumotion The base units do not include the tops - Note: fully extending drawers and deep drawers with blumotion system		COD.	BRIDGE ALKOR- CELL KS1	BRIDGE PET KS1				
 <p><b>1 cassetto H 12</b> <b>1 anta H 60</b> 1 drawer H 12 1 door H 60</p>	L 45	E4021451/2	234	264				
	 <p><b>1 cassetto H 12</b> <b>2 ante H 60</b> 1 drawer H 12 2 doors H 60</p>	L 90	E4021900	355	408			
 <p><b>1 anta</b> <b>2 cassetti interni</b> <b>1 cestone interno</b> <b>posizionare a 5 cm dalla parete laterale</b> 1 door 2 internal drawers 1 internal deep drawer <b>place at 5 cm from the side wall</b></p>		L 45	E4236461/2	363	412			
	L 60	E4236611/2	394	452				
 <p><b>1 anta</b> <b>2 cestoni interni</b> <b>posizionare a 5 cm dalla parete laterale</b> 1 door 2 internal deep drawers <b>place at 5 cm from the side wall</b></p>	L 45	E4236471/2	318	348				
	L 60	E4236621/2	348	384				
 <p><b>base tavolo estraibile LUNCH</b> <b>portata 60 kg</b> <b>1 anta H 60</b> <b>1 frontale H 12</b> base unit with pull-out table LUNCH load capacity kg 60 1 door H 60 1 front H 12</p>	L 60	E4230601/2	681	716				
	 <p><b>base tavolo estraibile LUNCH</b> <b>portata 60 kg</b> <b>2 ante H 60</b> <b>1 frontale H 12</b> base unit with pull-out table LUNCH load capacity kg 60 2 doors H 60 1 front H 12</p>	L 90	E4230900	774	828			
 <p><b>base tavolo estraibile PARTY</b> <b>gamba telescopica in alluminio</b> <b>portata 100 kg</b> <b>1 cassetto H 18</b> <b>1 cestone H 36</b> base unit with pull-out table PARTY telescopic legs in aluminium load capacity kg 100 1 drawers H 18 1 deep drawer H 36</p>		L 60	E4234600	1.297	1.334			
	L 90	E4234900	1.420	1.470				

# BASI ANGOLO

CORNER BASE UNITS

H 85 P 65

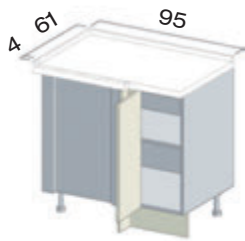
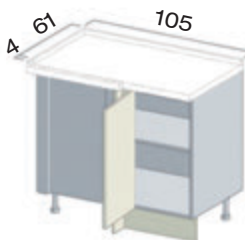
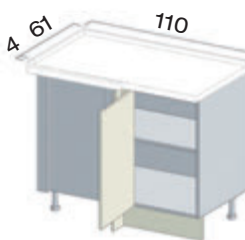
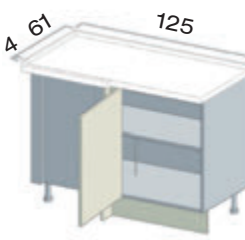
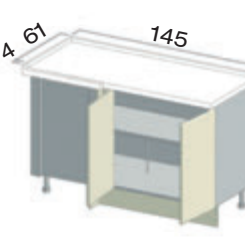
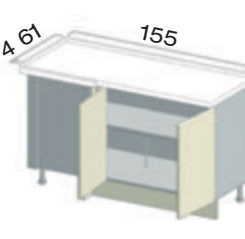
Le basi non sono comprensive di top - N.B.: cerniere ammortizzate di serie The base units do not include the tops - Note: standard blumotion hinges		COD.	BRIDGE ALKOR- CELL KS1	BRIDGE PET KS1				
 <p><b>angolo L 95</b> 1 ripiano 1 anta L 30 (cerniere a pilastro) cassone 90 corner unit W 95 1 shelf 1 door W 30 (pillar hinges) structure 90</p> <p>verso dx RH version</p>	95x65	E4400951/2	277	335				
 <p><b>angolo L 105</b> 1 ripiano 1 anta L 40 (cerniere a pilastro) cassone 90 corner unit W 105 1 shelf 1 door W 40 (pillar hinges) structure 90</p> <p>verso dx RH version</p>	105x65	E4401041/2	284	345				
 <p><b>angolo L 110</b> 1 ripiano 1 anta L 45 (cerniere a pilastro) cassone 105 corner unit W 110 1 shelf 1 door W 45 (pillar hinges) structure 105</p> <p>verso dx RH version</p>	110x65	E4401091/2	296	358				
 <p><b>angolo L 125</b> 1 ripiano 1 anta L 60 (cerniere a pilastro) cassone 120 con tirante corner unit W 125 1 shelf 1 door W 60 (pillar hinges) structure 120 with tie beam</p> <p>verso dx RH version</p>	125x65	E4401241/2	330	396				
 <p><b>angolo L 145</b> 1 ripiano 2 ante L 40 (cerniere a pilastro) cassone 140 con tirante corner unit W 145 1 shelf 2 doors W 40 (pillar hinges) structure 140 with tie beam</p> <p>verso dx RH version</p>	145x65	E4401451/2	420	504				
 <p><b>angolo L 155</b> 1 ripiano 2 ante L 45 (cerniere a pilastro) cassone 150 con tirante corner unit W 155 1 shelf 2 doors W 45 (pillar hinges) structure 150 with tie beam</p> <p>verso dx RH version</p>	155x65	E4401551/2	427	511				

# BASI ANGOLO

CORNER BASE UNITS

H 85 P 65

**Le basi non sono comprensive di top - N.B.: cerniere ammortizzate di serie**  
The base units do not include the tops - Note: standard blumotion hinges

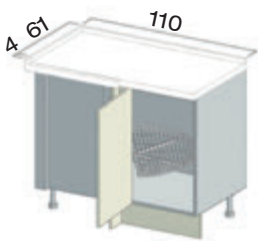
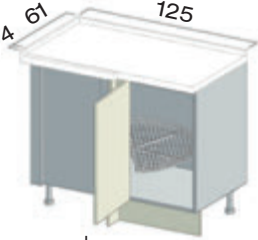
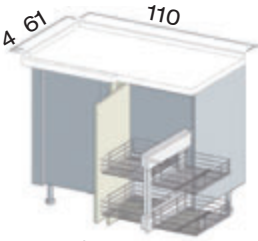
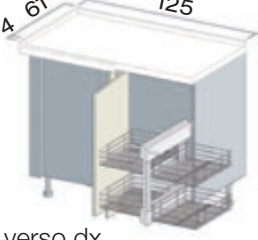
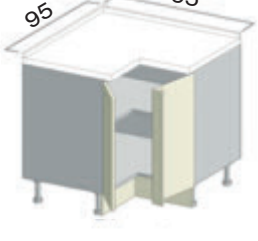
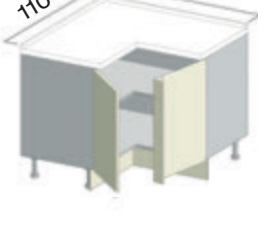
	COD.	BRIDGE ALKOR- CELL KS1	BRIDGE PET KS1			
 <p><b>angolo L 110</b> <b>cestello mezzaluna orion grau</b> <b>1 anta L 45 (cerniere a pilastro)</b> <b>cassone 105</b> corner unit W 110 crescent-shaped orion grau wire basket unit 1 door W 45 (pillar hinges) structure 105</p> <p>verso dx RH version</p>	<p><b>1 cestello 110x65</b> 1 basket drawer</p>	E4401101/2	304	365		
	<p><b>2 cestelli 110x65</b> 2 basket drawers</p>	E4401111/2	332	394		
 <p><b>angolo L 125</b> <b>cestello mezzaluna orion grau</b> <b>1 anta L 60 (cerniere a pilastro)</b> <b>cassone 120</b> corner unit W 125 crescent-shaped orion grau wire basket unit 1 door W 60 (pillar hinges) structure 120</p> <p>verso dx RH version</p>	<p><b>1 cestello 125x65</b> 1 basket unit</p>	E4401251/2	321	386		
	<p><b>2 cestelli 125x65</b> 2 basket units</p>	E4401261/2	349	415		
 <p><b>angolo L 110</b> <b>4 cestelli orion grau estraibili indipendenti dall'anta</b> <b>1 anta L 45 (cerniere a pilastro)</b> <b>cassone 105</b> corner unit W 110 4 pull-out orion grau basket unit opening independently from door 1 door W 45 (pillar hinges) structure 105</p> <p>verso dx RH version</p>		E4451101/2	814	875		
	110x65					
 <p><b>angolo L 125</b> <b>4 cestelli orion grau estraibili indipendenti dall'anta</b> <b>1 anta L 60 (cerniere a pilastro)</b> <b>cassone 120</b> corner unit W 125 4 pull-out orion grau basket units opening independently from door 1 door W 60 (pillar hinges) structure 120</p> <p>verso dx RH version</p>		E4451251/2	881	946		
	125x65					
 <p><b>angolo 95x95</b> <b>1 ripiano</b> <b>2 ante L 30 (cerniere 180°)</b> <b>angolare unito all'anta dx</b> corner unit 95x95 1 shelf 2 doors W 30 (180° hinges) angular filler attached to the RH door</p>		E4481950	579	658		
	95x95					
 <p><b>angolo 110x110</b> <b>1 ripiano</b> <b>2 ante L 45 (cerniere 180°)</b> <b>angolare unito all'anta dx</b> corner unit 110x110 1 shelf 2 doors W 45 (180° hinges) angular filler attached to the RH door</p>		E4482100	635	722		
	110x110					

# BASI ANGOLO PANNELLO COME ANTA

H 85 P 61

CORNER BASE UNITS PANEL AS DOOR

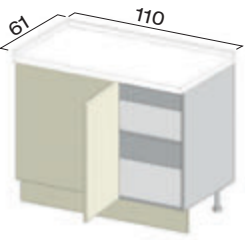
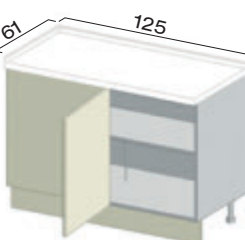
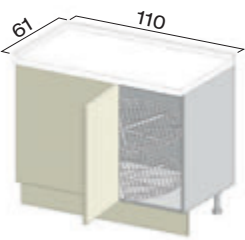
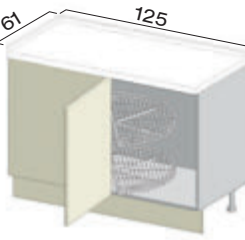
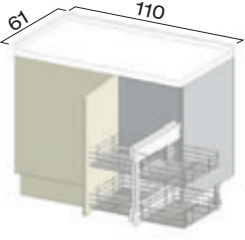
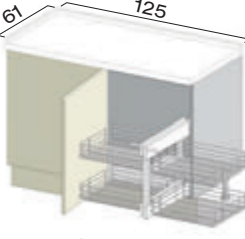
LE BASI NON SONO COMPRENSIVE DI TOP THE BASE UNITS DO NOT INCLUDE THE TOPS		COD.	BRIDGE ALKOR- CELL KS1	BRIDGE PET KS1				
 <p><b>angolo L 110</b> <b>1 ripiano</b> <b>1 anta L 45</b> <b>pannello come anta</b> <b>cassone 110</b> corner unit W 110 1 shelf 1 door W 45 panel as door structure 110</p> <p>verso dx RH version</p>	110x61	E4403091/2	311	362				
 <p><b>angolo L 125</b> <b>1 ripiano</b> <b>1 anta L 60</b> <b>pannello come anta</b> <b>cassone 125 con tirante</b> corner unit W 125 1 shelf 1 door W 60 panel as door structure 125 with tie beam</p> <p>verso dx RH version</p>	125x61	E4403241/2	329	385				
 <p><b>angolo L 110</b> <b>2 cestelli mezzaluna orion grau</b> <b>1 anta L 45</b> <b>pannello come anta</b> <b>cassone 110</b> corner unit W 110 2 crescent-shaped orion grau wire basket units 1 door W 45 panel as door structure 110</p> <p>verso dx RH version</p>	110x61	E4403111/2	335	386				
 <p><b>angolo L 125</b> <b>2 cestelli mezzaluna orion grau</b> <b>1 anta L 60</b> <b>pannello come anta</b> <b>cassone 125</b> corner unit W 125 2 crescent-shaped orion grau wire basket units 1 door W 60 panel as door structure 125</p> <p>verso dx RH version</p>	125x61	E4403261/2	353	409				
 <p><b>angolo L 110</b> <b>4 cestelli orion grau estraibili indipendenti dall'anta</b> <b>1 anta L 45</b> <b>pannello come anta</b> <b>cassone 110</b> corner unit W 110 4 pull-out orion grau basket units opening independently from door 1 door W 45 panel as door structure 110</p> <p>verso dx RH version</p>	110x61	E4453101/2	845	896				
 <p><b>angolo L 125</b> <b>4 cestelli orion grau estraibili indipendenti dall'anta</b> <b>1 anta L 60</b> <b>pannello come anta</b> <b>cassone 125</b> corner unit W 125 4 pull-out orion grau basket units opening independently from door 1 door W 60 panel as door structure 125</p> <p>verso dx RH version</p>	125x61	E4453251/2	913	969				





# BASI PER FORNI

OVEN BASE UNITS

H 85 P 61

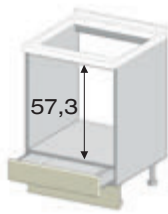
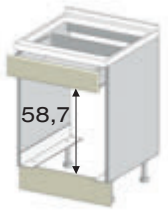
**Le basi non sono comprensive di top - N.B.: cassetti ad estrazione totale con blumotion**  
The base units do not include the tops - Note: fully extending drawers with blumotion system

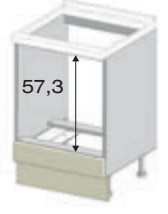
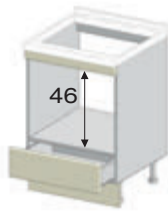
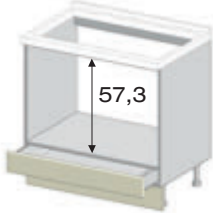
	COD.	BRIDGE ALKOR- CELL KS1	BRIDGE PET KS1				
 <p><b>base per forno elettrico H 60</b> <b>cassetto H 12 inferiore</b> electric oven base unit H 60 lower drawer H 12</p>							
	L 60 E5510607	195	205				
 <p><b>base per forno elettrico H 60</b> <b>cassetto H 12 superiore</b> electric oven base unit H 60 upper drawer H 12</p>							
	L 60 E5510608	195	205				
 <p><b>base per forno elettrico H 60</b> <b>frontale superiore fisso H 12</b> <b>N.B.: da utilizzare per top H 2 e per P.C. filo top</b> electric oven base unit H 60 fixed upper front H 12 Note: to be used in conjunction with tops H 2 and flush hobs</p>							
	L 60 E5510620	129	140				
 <p><b>base per forno gas H 60</b> <b>frontale inferiore fisso H 12</b> gas oven base unit H 60 fixed lower front H 12</p>							
	L 60 E5520600	131	142				
 <p><b>base per forno elettrico H 46</b> <b>fascia superiore H 8,1</b> <b>cassetto H 18</b> electric oven base unit H 46 upper filler H 8,1 drawer H 18</p>							
	L 60 E5530600	208	219				
 <p><b>base per maxiforno H 60</b> <b>cassetto H 12</b> maxi-oven base unit H 60 drawer H 12</p>							
	L 90 E5510907	239	252				

# BASI PER FORNI

OVEN BASE UNITS

H 85 P 61

**Le basi non sono comprensive di top - N.B.: cassetti ad estrazione totale con blumotion**  
 The base units do not include the tops - Note: fully extending drawers with blumotion system

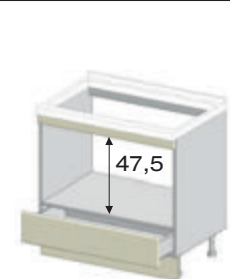

**base per maxiforno H 48**  
**fascia superiore H 5,9**  
**cassetto H 18**

maxi-oven base unit H 48  
 upper filler H 5,9  
 drawer H 18

L 90

COD.

**BRIDGE**  
 ALKOR-  
 CELL  
**KS1**

**BRIDGE**  
 PET  
**KS1**

E5510920

249

264



**kit raccordo base angolo**  
 junction kit corner base unit

110x110

E5471100

84

124



**kit raccordo base angolo per inserimento lavastoviglie a destra o sinistra**  
 junction kit for corner base unit for dishwasher placed on the right or the left side

verso dx  
 RH version

110x110

E5471151/2







119

157

# BASI PER PIANI COTTURA

COOKER HOB BASE UNITS



H 85 P 61

Le basi non sono comprensive di top - N.B.: cassetti e cestoni ad estrazione totale con blumotion The base units do not include the tops - Note: fully extending drawers and deep drawers with blumotion system		COD.	BRIDGE ALKOR- CELL KS1	BRIDGE PET KS1				
 <p><b>base predisposta piano cottura 1 anta</b> base unit configured for cooker hob 1 door</p>	L 60	E5500601/2	180	208				
		opz.101	+55	+55				
	<p><b>mag.base piano cottura ad induzione</b> surcharge base unit for induction cooker hob</p>							
 <p><b>base predisposta piano cottura 2 ante</b> base unit configured for cooker hob 2 doors</p>	L 90	E5500900	268	313				
		opz.101	+55	+55				
	<p><b>mag.base piano cottura ad induzione</b> surcharge base unit for induction cooker hob</p>							
 <p><b>Maggiorazione per base predisposta piano cottura ad induzione con lamierino di protezione</b> N.B.: realizzabile su base 2 cassetti+1 cestone, base 2 cestoni e base 4 cassetti Surcharge for base unit configured for induction cooker hob with protection metal sheet Note: available on base unit 2 drawers+1 deep drawer, base unit 2 deep drawers and base unit 4 drawers</p>		opz.101	+55	+55				
 <p><b>base predisposta piano cottura con cappa integrata</b> <b>1 frontale superiore fisso H 18</b> <b>1 cassetto H 18 P 40</b> <b>1 cestone H 36 P 40</b> base unit configured for cooker hob with integrated hood 1 fixed upper front H 18 1 drawer H 18 D 40 1 deep drawer H 36 D 40</p>	L 90	E5509090	414	465				
	L 120	E5509120	500	559				
 <p><b>base predisposta piano cottura con cappa integrata</b> <b>1 anta vasistas H 36</b> <b>1 cestone H 36 P 40</b> base unit configured for cooker hob with integrated hood 1 flap door H 36 1 deep drawer H 36 D 40</p>	L 90	E5509095	490	537				
	L 120	E5509125	556	612				
 <p><b>Esempio di piano cottura con cappa integrata</b> Example of cooker hob with integrated hood</p>								

# SOTTOLAVELLI

SINK BASE UNITS

H 85 P 61

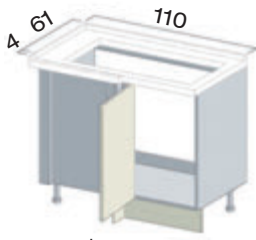
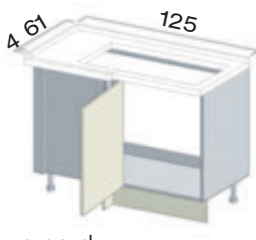
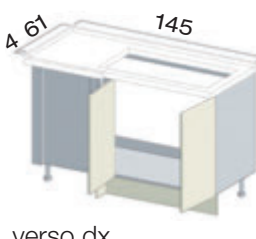
Le basi non sono comprensive di top - N.B.: cerniere ammortizzate di serie The base units do not include the tops - Note: standard blumotion hinges		COD.	BRIDGE ALKOR- CELL KS1	BRIDGE PET KS1				
 <p><b>sottolavello 1 anta</b> sink base unit 1 door</p>	L 45	E5010451/2	155	178				
	L 60	E5010601/2	173	200				
 <p><b>sottolavello 2 ante</b> sink base unit 2 doors</p>	L 60	E5010600	217	255				
	L 80	E5010800	248	293				
	L 90	E5010900	252	298				
	L 120	E5011200	291	345				
 <p><b>sottolavello 2 cestoni H 36</b> <b>cestone superiore sagomato con vaschette</b> sink base unit 2 deep drawers H 36 contoured upper deep drawer with trays</p>	L 60	E5200600	361	398				
	L 90	E5200900	446	493				
	L 120	E5201200	478	534				
 <p><b>sottolavello angolo L 110</b> <b>1 anta L 45 (cerniere pilastro)</b> <b>cassone 105</b> corner sink base unit W 110 1 door W 45 (pillar hinges) structure 105</p> <p>verso dx RH version</p>	110x65	E4421101/2	279	340				
 <p><b>sottolavello angolo L 125</b> <b>1 anta L 60 (cerniere pilastro)</b> <b>cassone 120</b> corner sink base unit W 125 1 door W 60 (pillar hinges) structure 120</p> <p>verso dx RH version</p>	125x65	E4421251/2	296	362				
 <p><b>sottolavello angolo L 145</b> <b>2 ante L 40 (cerniere pilastro)</b> <b>cassone 140</b> corner sink base unit W 145 2 doors W 40 (pillar hinges) structure 140</p> <p>verso dx RH version</p>	145x65	E4421451/2	370	455				

# SOTTOLAVELLI

SINK BASE UNITS

H 85 P 61

**Le basi non sono comprensive di top - N.B.: cerniere ammortizzate di serie**  
 The base units do not include the tops - Note: standard blumotion hinges

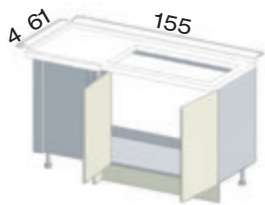

verso dx  
 RH version

**sottolavello angolo L 155**  
**2 ante L 45 (cerniere pilastro)**  
**cassone 150**  
 corner sink base unit W 155  
 2 doors W 45 (pillar hinges)  
 structure 150

155x65

COD.

**BRIDGE**  
 ALKOR-  
 CELL  
**KS1**

**BRIDGE**  
 PET  
**KS1**

E4421551/2

376

461

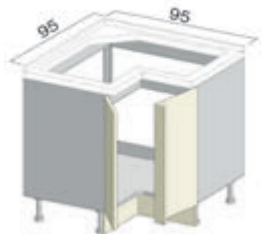

**sottolavello angolo 95x95**  
**2 ante L 30 (cerniere 180°)**  
**angolare unito all'anta dx**  
 corner sink base unit 95x95  
 2 doors W 30 (180° hinges)  
 angular filler attached to the RH door

95x95

E5021950

584

661

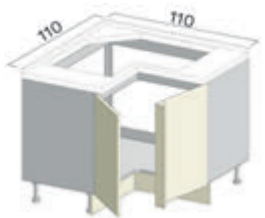

**sottolavello angolo 110x110**  
**2 ante L 45 (cerniere 180°)**  
**angolare unito all'anta dx**  
 corner sink base unit 110x110  
 2 doors W 45 (180° hinges)  
 angular filler attached to the RH door

110x110

E5022100







642

727

# BASI PER ELETTRODOMESTICI SOTTOTOP

BASE UNITS FOR UNDER-TOP APPLIANCES

H 85 P 61





Le basi non sono comprensive di top The base units do not include the tops		COD.	BRIDGE ALKOR- CELL KS1	BRIDGE PET KS1				
 <p><b>anta per lavastoviglie scomparsa totale completa di kit protezione fianchi</b> door for fully integrated dishwasher with protection kit for side panels</p>	L 45	E4490080	100	124				
	L 60	E4490090	116	145				
 <p><b>anta per lavastoviglie scomparsa totale estetica 2 cestoni completa di kit protezione fianchi</b> door for fully integrated dishwasher 2 deep drawers aesthetic with protection kit for side panels</p>	L 60	E4490100	154	194				
	L 45	E4490050	86	109				
 <p><b>anta per lavastoviglie comandi a vista completa di kit protezione fianchi</b> door for dishwasher with visible controls with protection kit for side panels</p>	L 60	E4490060	96	122				
	 <p><b>kit protezione fianchi per lavastoviglie</b> protection kit for side panels for dishwasher</p> 							
 <p><b>anta per lavabiancheria scomparsa totale</b> door for fully integrated washing machine</p>	L 60	E4490011/2	116	145				



# BASI E SOTTOLAVELLI H 73

BASE UNITS AND SINK BASE UNITS H 73

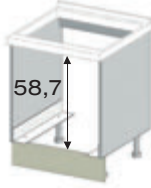
H 73 P 61

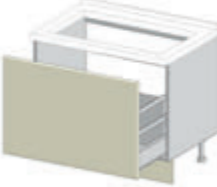
Le basi non sono comprensive di top - N.B.: cerniere ammortizzate di serie The base units do not include the tops - Note: standard blumotion hinges		COD.	BRIDGE ALKOR- CELL KS1	BRIDGE PET KS1				
 <p><b>base H 73 1 anta</b> base unit H 73 1 door</p>	L 45	E4030451/2	156	177				
	L 60	E4030601/2	173	198				
 <p><b>base H 73 2 ante</b> base unit H 73 2 doors</p>	L 90	E4030900	256	298				
	L 120	E4031200	309	358				
 <p><b>base H 73 2 cassetti H 18 1 cassetto H 24</b> base unit H 73 2 drawers H 18 1 drawer H 24</p>	L 45	E4250450	338	373				
	L 60	E4250600	363	398				
	L 90	E4250900	446	491				
	L 120	E4251200	498	552				
 <p><b>base H 73 predisposta per forno H 60</b> base unit H 73 configured for oven H 60</p> <p>58,7</p>	L 60	E5540600	117	117				
 <p><b>sottolavello H 73 1 anta</b> sink base unit H 73 1 door</p>	L 45	E5060451/2	153	173				
	L 60	E5060601/2	168	192				
 <p><b>sottolavello H 73 2 ante</b> sink base unit H 73 2 doors</p>	L 90	E5060900	245	286				
	L 120	E5061200	280	329				
 <p><b>sottolavello H 73 1 cestone H 60 con scarico salvaspazio</b> sink base unit H 73 1 deep drawer H 60 with space-saver drain piping</p>	L 60	E5260600	313	337				
	L 90	E5260900	349	381				







# BASI SOSPENSE con Attaccaglie e Barre Fissaggio a parete

H 36 - 48 - 60 P 61

HANGING BASE UNITS with Hangers and Rods for wall mounting

**Le basi non sono comprensive di top - N.B.: cerniere ammortizzate di serie**  
 The base units do not include the tops - Note: standard blumotion hinges





	COD.	BRIDGE ALKOR- CELL KS1	BRIDGE PET KS1				
 <p><b>base H 36 1 anta</b> base unit H 36 1 door</p>	L 45	E4321451/2	140	156			
	L 60	E4321601/2	146	167			
 <p><b>base H 48 1 anta</b> base unit H 48 1 door</p>	L 45	E4320451/2	160	179			
	L 60	E4320601/2	170	194			
 <p><b>base H 60 1 anta</b> base unit H 60 1 door</p>	L 45	E4322451/2	174	195			
	L 60	E4322601/2	186	212			
 <p><b>base H 36 2 ante</b> base unit H 36 2 doors</p>	L 90	E4321900	210	243			
	L 120	E4322200	230	269			
 <p><b>base H 48 2 ante</b> base unit H 48 2 doors</p>	L 90	E4320900	243	281			
	L 120	E4321200	286	330			
 <p><b>base H 60 2 ante</b> base unit H 60 2 doors</p>	L 90	E4322900	261	304			

# BASI SOSPESSE con Attaccaglie e Barre Fissaggio a parete

H 36 - 48 - 60 P 61

HANGING BASE UNITS with Hangers and Rods for wall mounting



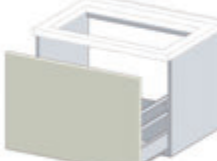



**Le basi non sono comprensive di top - N.B.: cassetti e cestoni ad estrazione totale con blumotion**  
The base units do not include the tops - Note: fully extending drawers and deep drawers with blumotion system

	COD.	BRIDGE ALKOR- CELL KS1	BRIDGE PET KS1				
 <p><b>base H 36</b> <b>1 cestone</b> base H 36 1 deep drawer</p>	L 45	E4311450	191	207			
	L 60	E4311600	202	222			
	L 90	E4311900	238	277			
	L 120	E4312200	261	289			
 <p><b>base H 48</b> <b>1 cestone</b> base unit H 48 1 deep drawer</p>	L 45	E4310450	207	225			
	L 60	E4310600	219	242			
	L 90	E4310900	259	302			
	L 120	E4311200	290	323			
 <p><b>base H 60</b> <b>1 cestone</b> <b>1 cassetto interno</b> base unit H 60 1 deep drawer 1 internal drawer</p>	L 45	E4312450	316	352			
	L 60	E4312600	333	377			
	L 90	E4312900	393	443			
 <p><b>sottolavello H 48</b> <b>1 cestone sagomato scarico salvaspazio</b> sink base unit H 48 1 contoured deep drawer space-saver drain piping</p>	L 90	E5240900	322	350			
 <p><b>sottolavello H 60</b> <b>1 cestone scarico salvaspazio</b> sink base unit H 60 1 deep drawer with space-saver drain piping</p>	L 60	E5250600	317	341			
	L 90	E5250900	355	387			

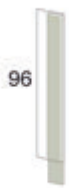
# COLONNE H 109

COLUMNS H 109



P 59,6

Le colonne non sono comprensive di top - N.B.: cerniere ammortizzate di serie The columns do not include the tops - Note: standard blumotion hinges		COD.	BRIDGE ALKOR- CELL KS1	BRIDGE PET KS1			
 <p><b>fascia tamponamento da 5 a 15</b> filler panel size from 5 to 15</p>							
	<p><b>in nobilitato</b> melamine coated</p>	E6000010	50	50			
	<p><b>come anta con supporto</b> same as door with support</p>	E6000140	82	106			
 <p><b>1 anta</b> 1 door</p>							
	<b>L 30</b>	E6040301/2	185	207			
	<b>L 40</b>	E6040401/2	199	225			
	<b>L 45</b>	E6040451/2	204	232			
	<b>L 60</b>	E6040601/2	231	265			
 <p><b>2 ante</b> <b>2 ripiani con tirante centrale</b> 2 doors 2 shelves with central tie beam</p>							
	<b>L 90</b>	E6041900	334	390			
 <p><b>1 anta vetro</b> 1 glass door</p>							
	<b>telaio alkorcell L 45</b> alkorcell frame	E6046451/2	225	—			
	<b>telaio PET L 45</b> PET frame	E6046451/2	—	262			
 <p><b>2 ante vetro</b> 2 glass doors</p>							
	<b>telaio alkorcell L 90</b> alkorcell frame	E6046900	381	—			
	<b>telaio PET L 90</b> PET frame	E6046900	—	455			
 <p><b>1 cassetto H 24</b> <b>2 cestoni H 36</b> 1 drawer H 24 2 deep drawers H 36</p>							
	<b>L 60</b>	E6031620	444	490			

# COLONNE H 109

P 59,6

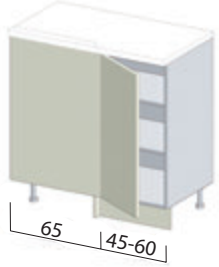
COLUMNS H 109







Le colonne non sono comprensive di top - N.B.: cerniere ammortizzate di serie The columns do not include the tops - Note: standard blumotion hinges		COD.	BRIDGE ALKOR- CELL KS1	BRIDGE PET KS1				
 <p><b>predisposta per lavastoviglie</b> <b>Electrolux KESC 5300L - AEG FSE63307P</b> configured for Electrolux KESC 5300L AEG FSE 63307P dishwasher</p>	L 60	E6570600	315	351				
	 <p><b>angolo 2 ripiani con tirante centrale</b> <b>1 anta (cerniere a pilastro)</b> <b>pannello come anta sp. 2,2</b> corner unit 2 shelves with central tie beam 1 door (pillar hinges) panel as door Th. 2,2</p> <p>65   45-60</p>	L 110	E6327101/2	363	419			
L 125		E6327251/2	392	453				
 <p><b>jolly colonna folding</b> <b>L da 10 a 30</b> folding jolly column size from 10 to 30</p> <p><b>colore come struttura</b> same colour as carcass</p> <p><b>colore come anta alkorcell</b> same colour as alkorcell door</p> <p><b>colore come anta PET</b> same colour as PET door</p>			E6000900	190	190			
		E6000930	285	—				
		E6000925	—	527				

BRIDGE  
COLONNE  
COLUMNS

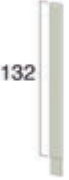
# COLONNE H 145

COLUMNS H 145







P 59,6

Le colonne non sono comprensive di top - N.B.: cerniere ammortizzate di serie The columns units do not include the tops - Note: standard blumotion hinges		COD.	BRIDGE ALKOR- CELL KS1	BRIDGE PET KS1				
 <p><b>fascia tamponamento da 5 a 15</b> filler panel size from 5 to 15</p>								
	<p><b>in nobilitato</b> melamine coated</p>	E6000020	51	51				
	<p><b>come anta con supporto</b> same as door with support</p>	E6000150	92	133				
 <p><b>1 anta</b> 1 door</p>								
	L 30	E6050301/2	215	243				
	L 45	E6050451/2	242	278				
	L 60	E6050601/2	270	313				
 <p><b>2 ante</b> <b>2 ripiani con tirante centrale</b> 2 doors 2 shelves with central tie beam</p>								
	L 90	E6050900	403	474				
 <p><b>1 anta vetro</b> 1 glass door</p>								
	<b>telaio alkorcell L 30</b> alkorcell frame	E6180301/2	237	—				
	L 45	E6180451/2	271	—				
	L 60	E6180601/2	311	—				
	<b>telaio PET L 30</b> PET frame	E6180301/2	—	275				
	L 45	E6180451/2	—	318				
L 60	E6180601/2	—	370					
 <p><b>2 ante vetro</b> 2 glass doors</p>								
	<b>telaio alkorcell L 90</b> alkorcell frame	E6180900	462	—				
	<b>telaio PET L 90</b> PET frame	E6180900	—	557				
 <p><b>1 anta integrata al gruppo cestelli estraibili</b> <b>in filo orion grau</b> <b>chiusura soft</b> 1 door incorporated into the orion grau wire pull-out basket units soft-closing system</p>								
	L 30	E6150300	488	516				

# COLONNE H 145

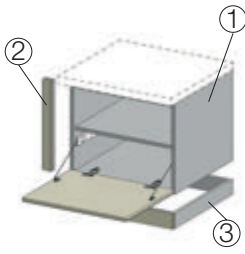
P 59,6







COLUMNS H 145

Le colonne non sono comprensive di top - N.B.: cerniere ammortizzate di serie The columns units do not include the tops - Note: standard blumotion hinges		COD.	BRIDGE ALKOR- CELL KS1	BRIDGE PET KS1			
 <p><b>1 anta</b> <b>gruppo cestelli estraibili in filo orion grau</b> <b>chiusura soft</b> 1 door orion grau wire pull-out basket units soft-closing system</p>	L 45	E6150451/2	513	548			
	L 60	E6150601/2	557	599			
 <p><b>1 anta vetro</b> <b>gruppo cestelli estraibili in filo orion grau</b> <b>chiusura soft</b> 1 glass door orion grau wire pull-out basket units soft-closing system</p>							
	telaio alkorcell L 45 alkorcell frame	E6152451/2	547	—			
	L 60	E6152601/2	605	—			
	telaio PET L 45 PET frame	E6152451/2	—	594			
L 60	E6152601/2	—	665				
 <p><b>mobile H 60 L 65</b> <b>apertura a vasistas push-pull</b> <b>con fascia di tamponamento laterale e inferiore</b> <b>in appoggio su base angolo</b> unit H 60 W 65 flap door push-pull opening with lateral and lower filler panel resting on corser base unit</p> <p>① ② ③</p> <p>verso sx LH version</p>							
	1. elemento H 48 L 60 unit H 48 W 60	E2520600	285	306			
	2. fascia laterale H 48 L 5 lateral filler panel H 48 W 5	E278000A	50	69			
3. fascia inferiore H 12 L 65 lower filler panel H 12 W 65	E2882000	57	77				
 <p><b>Esempio</b> <b>di mobile in appoggio su base angolo</b> <b>con colonna H 132 affiancata</b> <b>Example</b> of unit resting on corser base unit with side by side column H 132</p> <p>verso sx LH version</p>							
 <p><b>angolo 2 ripiani con tirante centrale</b> <b>1 anta (cerniere a pilastro)</b> <b>pannello come anta sp.2,2</b> corner unit 2 shelves with central tie beam 1 door (hinges pillar) panel as door Th. 2,2</p> <p>65 45-60</p>	L 110	E6336101/2	432	503			
	L 125	E6336251/2	458	536			
 <p><b>jolly colonna folding</b> <b>L da 10 a 30</b> folding jolly column size from 10 to 30</p>							
	colore come struttura same colour as carcass	E6001000	218	218			
	colore come anta alkorcell same colour as alkorcell door	E6001030	371	—			
colore come anta PET same colour as PET door	E6001025	—	696				

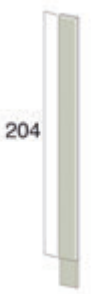
# COLONNE H 217

COLUMNS H 217







P 33,1 - 59,6

<b>N.B.: cerniere ammortizzate di serie</b> Note: standard blumotion hinges		COD.	BRIDGE ALKOR- CELL KS1	BRIDGE PET KS1			
 <p><b>fascia tamponamento da 5 a 15</b> filler panel size from 5 to 15</p> <p>204</p>							
	in nobilitato melamine coated	E6000050	58	58			
	come anta con supporto same as door with support	E6000200	118	168			
 <p><b>2 ante</b> <b>anta superiore H 72</b> <b>anta inferiore H 132</b> 2 doors upper door H 72 lower door H 132</p>							
	L 45 P 33,1	E601345A1/2	327	386			
	L 60 P 33,1	E601360A1/2	373	446			
 <p><b>2 ante</b> <b>anta superiore H 72</b> <b>anta inferiore H 132</b> 2 doors upper door H 72 lower door H 132</p>							
	L 30 P 59,6	E606030A1/2	328	376			
	L 45 P 59,6	E606345A1/2	362	422			
	L 60 P 59,6	E606360A1/2	415	488			
	L 75 P 59,6	E606375A1/2	512	597			
 <p><b>2 ante</b> <b>anta superiore H 132</b> <b>anta inferiore H 72</b> 2 doors upper door H 132 lower door H 72</p>							
	L 45 P 33,1	E601045A1/2	327	386			
	L 60 P 33,1	E601060A1/2	373	446			
 <p><b>2 ante</b> <b>anta superiore H 132</b> <b>anta inferiore H 72</b> 2 doors upper door H 132 lower door H 72</p>							
	L 45 P 59,6	E606045A1/2	362	422			
	L 60 P 59,6	E606060A1/2	415	488			
	L 75 P 59,6	E606075A1/2	512	597			
 <p><b>4 ante</b> <b>2 ante superiori H 132</b> <b>2 ante inferiori H 72</b> <b>4 ripiani con tirante centrale</b> 4 doors 2 upper doors H 132 2 lower doors H 72 4 shelves with central tie beam</p>							
	L 90 P 59,6	E606090A0	615	732			

# COLONNE H 217

COLUMNS H 217

P 33,1 - 59,6

N.B.: cassetti e cestoni ad estrazione totale con blumotion Note: fully extending drawers and deep drawers with blumotion system		COD.	BRIDGE ALKOR- CELL KS1	BRIDGE PET KS1				
 <p><b>portascope</b> <b>2 ante</b> <b>anta superiore H 72</b> <b>anta inferiore H 132</b> broom cabinet 2 doors upper door H 72 lower door H 132</p>	L 30 P 59,6	E610030A1/2	328	376				
	L 45 P 59,6	E610045A1/2	356	415				
 <p><b>portascope con ripiani</b> <b>2 ante</b> <b>anta superiore H 72</b> <b>anta inferiore H 132</b> broom cabinet with shelves 2 doors upper door H 72 lower door H 132</p>	L 60 P 59,6	E610060A1/2	440	513				
 <p><b>1 anta H 132</b> <b>4 cassetti H 18</b> 1 door H 132 4 drawers H 18</p>	L 45 P 59,6	E6065451/2	585	659				
	L 60 P 59,6	E6065601/2	643	722				
 <p><b>1 anta H 132</b> <b>2 cassetti H 18</b> <b>1 cestone H 36</b> 1 door H 132 2 drawers H 18 1 deep drawer H 36</p>	L 45 P 59,6	E6065461/2	535	605				
	L 60 P 59,6	E6065611/2	586	665				
 <p><b>1 anta H 132</b> <b>2 cestoni H 36</b> 1 door H 132 2 deep drawers H 36</p>	L 45 P 59,6	E6066451/2	484	550				
	L 60 P 59,6	E6066601/2	529	608				
 <p><b>2 ante</b> <b>anta vetro H 132</b> <b>anta chiusa H 72</b> 2 doors glass door H 132 full door H 72</p>	telaio alkorcell L 30 P 33,1 alkorcell frame	E6202301/2	295	314				
	L 45 P 33,1	E6202451/2	349	371				
	L 60 P 33,1	E6202601/2	397	424				
	telaio PET L 30 P 33,1 PET frame	E6202301/2	332	351				
	L 45 P 33,1	E6202451/2	397	419				
	L 60 P 33,1	E6202601/2	457	484				









# COLONNE H 217

COLUMNS H 217

P 33,1 - 59,6







**N.B.: cassetti e cestoni ad estrazione totale con blumotion**  
 Note: fully extending drawers and deep drawers with blumotion system

		COD.	BRIDGE ALKOR- CELL KS1	BRIDGE PET KS1				
 <p><b>2 ante</b>  <b>anta vetro H 132</b>  <b>anta chiusa H 72</b>                      2 doors                      glass door H 132                      full door H 72</p>	telaio alkorcell L 30 P 59,6 alkorcell frame	E6201301/2	337	356				
	L 45 P 59,6	E6201451/2	382	405				
	L 60 P 59,6	E6201601/2	435	462				
	telaio PET L 30 P 59,6 PET frame	E6201301/2	374	393				
	L 45 P 59,6	E6201451/2	429	452				
	L 60 P 59,6	E6201601/2	494	521				
 <p><b>2 ante vetro</b>  <b>anta superiore H 132</b>  <b>anta inferiore H 72</b>                      2 glass doors                      upper door H 132                      lower door H 72</p>	telaio alkorcell L 30 P 33,1 alkorcell frame	E6200311/2	308	—				
	L 45 P 33,1	E6200461/2	363	—				
	L 60 P 33,1	E6200611/2	422	—				
	telaio PET L 30 P 33,1 PET frame	E6200311/2	—	370				
	L 45 P 33,1	E6200461/2	—	441				
	L 60 P 33,1	E6200611/2	—	518				
 <p><b>2 ante vetro</b>  <b>anta superiore H 132</b>  <b>anta inferiore H 72</b>                      2 glass doors                      upper door H 132                      lower door H 72</p>	telaio alkorcell L 30 P 59,6 alkorcell frame	E6200301/2	350	—				
	L 45 P 59,6	E6200451/2	398	—				
	L 60 P 59,6	E6200601/2	459	—				
	telaio PET L 30 P 59,6 PET frame	E6200301/2	—	413				
	L 45 P 59,6	E6200451/2	—	475				
	L 60 P 59,6	E6200601/2	—	556				
 <p><b>4 ante</b>  <b>2 ante vetro H 132</b>  <b>2 ante chiuse H 72</b>                      4 doors                      2 glass doors H 132                      2 full doors H 72</p>	telaio alkorcell L 90 P 59,6 alkorcell frame	E6201900	675	720				
	telaio PET L 90 P 59,6 PET frame	E6201900	770	815				
 <p><b>1 anta vetro H 132</b>  <b>4 cassetti H 18</b>                      1 glass door H 132                      4 drawers H 18</p>	telaio alkorcell L 45 P 59,6 alkorcell frame	E6284451/2	618	658				
	L 60 P 59,6	E6284601/2	691	729				
	telaio PET L 45 P 59,6 PET frame	E6284451/2	665	705				
	L 60 P 59,6	E6284601/2	750	788				
 <p><b>1 anta vetro H 132</b>  <b>2 cassetti H 18</b>  <b>1 cestone H 36</b>                      1 glass door H 132                      2 drawers H 18                      1 deep drawer H 36</p>	telaio alkorcell L 45 P 59,6 alkorcell frame	E6284461/2	568	604				
	L 60 P 59,6	E6284611/2	634	672				
	telaio PET L 45 P 59,6 PET frame	E6284461/2	615	651				
	L 60 P 59,6	E6284611/2	693	731				

# COLONNE H 217

P 59,6



COLUMNS H 217

<b>N.B.: cassette e cestoni ad estrazione totale con blumotion</b> Note: fully extending drawers and deep drawers with blumotion system		COD.	BRIDGE ALKOR- CELL KS1	BRIDGE PET KS1										
 <p><b>1 anta vetro H 132</b> <b>2 cestoni H 36</b> 1 glass door H 132 2 deep drawers H 36</p>														
								telaio alkorcell L 45 alkorcell frame	E6285451/2	517	549			
								L 60	E6285601/2	575	612			
								telaio PET L 45 PET frame	E6285451/2	564	596			
								L 60	E6285601/2	635	672			
 <p><b>1 anta H 204</b> 1 door H 204</p>														
								L 45	E6061451/2	375	434			
								L 60	E6061601/2	442	513			
 <p><b>portascope</b> <b>1 anta H 204</b> broom cabinet 1 door H 204</p>														
								L 45	E6100461/2	359	418			
 <p><b>portascope con ripiani</b> <b>1 anta H 204</b> broom cabinet with shelves 1 door H 204</p>														
								L 60	E6100611/2	465	535			
 <p><b>anta H 204 integrata al gruppo cestelli estraibili in filo orion grau</b> <b>chiusura soft</b> door H 204 incorporated into the orion grau wire pull-out basket unit soft-closing system</p>														
								L 30	E6163300	663	711			
								L 45	E6163450	723	780			
 <p><b>1 anta superiore H 72</b> <b>1 anta H 132 integrata al gruppo cestelli estraibili in filo orion grau</b> <b>chiusura soft</b> 1 upper door H 72 1 door H 132 incorporated into the orion grau wire pull-out basket unit soft-closing system</p>														
								L 30	E616030A1/2	596	642			

# COLONNE H 217

COLUMNS H 217

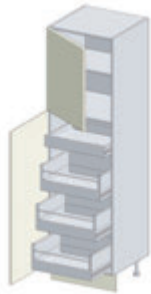





P 59,6

N.B.: cassetti e cestoni ad estrazione totale con blumotion Note: fully extending drawers and deep drawers with blumotion system		COD.	BRIDGE ALKOR- CELL KS1	BRIDGE PET KS1				
 <p><b>1 anta superiore H 72</b> <b>1 anta inferiore H 132</b> <b>gruppo cestelli estraibili in filo orion grau</b> <b>chiusura soft</b> 1 upper door H 72 1 lower door H 132 orion grau wire pull-out basket units soft-closing system</p>	L 45	E616045A1/2	633	691				
	L 60	E616060A1/2	691	760				
 <p><b>1 anta superiore H 72 (cerniere 100°)</b> <b>1 anta inferiore H 132 (cerniere 180°)</b> <b>1 cassetto interno</b> <b>3 cestoni interni</b> <b>posizionare sempre a 5 cm dalla parete laterale</b> 1 upper door H 72 (100° hinges) 1 lower door H 132 (180° hinges) 1 internal drawer 3 internal deep drawers <i>should always be placed at 5 cm from the side wall</i></p>	L 45	E608648A1/2	659	717				
	L 60	E608663A1/2	720	789				
 <p><b>angolo 4 ripiani con tirante centrale</b> <b>1 anta superiore H 72</b> <b>1 anta inferiore H 132</b> <b>(cerniere a pilastro)</b> <b>pannello come anta sp.2,2</b> corner unit 4 shelves with central tie beam 1 upper door H 72 1 lower door H 132 (pillar hinges) panel as door Th. 2,2</p>	L 110	E6306101/2	626	747				
	L 125	E6306251/2	664	796				
 <p><b>angolo 1 anta H 204 cerniere 135°</b> <b>2 fianchi sp. 3,8 come struttura</b> <b>N.B.: fornita smontata</b> corner 1 door H 204 135° hinges 2 side panels Th.3,8 same as carcass <i>Note: supplied unassembled</i></p>	105,5x105,5	E6341051/2	967	1.033				
	<p><b>jolly colonna folding</b> <b>L da 15 a 30</b> folding jolly column size from 15 to 30</p>							
			colore come struttura same colour as carcass	E6002000	285	285		
			colore come anta alkorcell same colour as alkorcell door	E6002030	521	—		
			colore come anta PET same colour as PET door	E6002025	—	1.008		

# COLONNE H 241

COLUMNS H 241







P 33,1 - 59,6

N.B.: cerniere ammortizzate di serie Note: standard blumotion hinges		COD.	BRIDGE ALKOR- CELL KS1	BRIDGE PET KS1				
 <p><b>fascia tamponamento da 5 a 15</b> filler panel size from 5 to 15</p> <p>228</p>								
	<p><b>in nobilitato</b> melamine coated</p>	E6000100	58	58				
	<p><b>come anta con supporto</b> same as door with support</p>	E6000250	118	176				
 <p><b>2 ante</b> <b>anta superiore H 96</b> <b>anta inferiore H 132</b> 2 doors upper door H 96 lower door H 132</p>								
	L 45 P 33,1	E602345A1/2	383	448				
	L 60 P 33,1	E602360A1/2	439	519				
 <p><b>2 ante</b> <b>anta superiore H 96</b> <b>anta inferiore H 132</b> 2 doors upper door H 96 lower door H 132</p>								
	L 30 P 59,6	E607030A1/2	353	405				
	L 45 P 59,6	E607345A1/2	392	457				
	L 60 P 59,6	E607360A1/2	455	535				
 <p><b>2 ante</b> <b>anta superiore H 156</b> <b>anta inferiore H 72</b> 2 doors upper door H 156 lower door H 72</p>								
	L 45 P 33,1	E602045A1/2	383	448				
	L 60 P 33,1	E602060A1/2	435	514				
 <p><b>2 ante</b> <b>anta superiore H 156</b> <b>anta inferiore H 72</b> 2 doors upper door H 156 lower door H 72</p>								
	L 45 P 59,6	E607045A1/2	392	457				
	L 60 P 59,6	E607060A1/2	451	530				
 <p><b>4 ante</b> <b>2 ante superiori H 156</b> <b>2 ante inferiori H 72</b> <b>4 ripiani con tirante centrale</b> 4 doors 2 upper doors H 156 2 lower doors H 72 4 shelves with central tie beam</p>								
	L 90 P 59,6	E607090A0	664	790				

# COLONNE H 241

COLUMNS H 241







P 33,1 - 59,6

N.B.: cassetti e cestoni ad estrazione totale con blumotion Note: fully extending drawers and deep drawers with blumotion system		COD.	BRIDGE ALKOR- CELL KS1	BRIDGE PET KS1				
 <p><b>portascope</b> 1 anta superiore H 96 1 anta inferiore H 132 broom cabinet 1 upper door H 96 1 lower door H 132</p>	L 30 P 59,6	E611030A1/2	354	406				
	L 45 P 59,6	E611045A1/2	386	450				
 <p><b>portascope con ripiani</b> 1 anta superiore H 96 1 anta inferiore H 132 broom cabinet with shelves 1 upper door H 96 1 lower door H 132</p>	L 60 P 59,6	E611060A1/2	468	547				
 <p><b>1 anta H 156</b> <b>4 cassetti H 18</b> 1 door H 156 4 drawers H 18</p>	L 45 P 59,6	E6075451/2	614	692				
	L 60 P 59,6	E6075601/2	676	761				
 <p><b>1 anta H 156</b> <b>2 cassetti H 18</b> <b>1 cestone H 36</b> 1 door H 156 2 drawers H 18 1 deep drawer H 36</p>	L 45 P 59,6	E6075461/2	563	638				
	L 60 P 59,6	E6075611/2	619	704				
 <p><b>1 anta H 156</b> <b>2 cestoni H 36</b> 1 door H 156 2 deep drawers H 36</p>	L 45 P 59,6	E6076451/2	512	583				
	L 60 P 59,6	E6076601/2	562	646				
 <p><b>2 ante vetro (solo telaio PET)</b> <b>anta superiore H 156</b> <b>(anta unita 132 vetro+24 piena)</b> <b>anta inferiore H 72</b> 2 glass doors (only PET frame) upper door H 156 <b>(joint glass door 132+full door 24)</b> lower door H 72</p>	telaio PET L 45 P 33,1 PET frame	E6210461/2	—	540				

# COLONNE H 241

COLUMNS H 241





P 33,1 - 59,6

<b>N.B.: cassetti e cestoni ad estrazione totale con blumotion</b> Note: fully extending drawers and deep drawers with blumotion system		COD.	BRIDGE ALKOR- CELL KS1	BRIDGE PET KS1				
 <p><b>2 ante vetro (solo telaio PET)</b>  <b>anta superiore H 156</b>                      (anta unita 132 vetro+24 piena)  <b>anta inferiore H 72</b>                      2 glass doors (only PET frame)                      upper door H 156                      (joint glass door 132+full door 24)                      lower door H 72</p>	<p>telaio PET L 45 P 59,6                      PET frame</p>	E6210451/2	—	549				
	 <p><b>2 ante</b>  <b>anta vetro H 156 (solo telaio PET)</b>                      (anta unita 132 vetro+24 piena)  <b>anta chiusa H 72</b>                      2 doors                      glass door H 156 (only PET frame)                      (joint glass door 132+full door 24)                      full door H 72</p>	<p>telaio PET L 45 P 33,1                      PET frame</p>	E6212451/2	494	516			
 <p><b>2 ante</b>  <b>anta vetro H 156 (solo telaio PET)</b>                      (anta unita 132 vetro+24 piena)  <b>anta chiusa H 72</b>                      2 doors                      glass door H 156 (only PET frame)                      (joint glass door 132+full door 24)                      full door H 72</p>		<p>telaio PET L 45 P 59,6                      PET frame</p>	E6211451/2	502	525			
	 <p><b>4 ante</b>  <b>2 ante vetro H 156 (solo telaio PET)</b>                      (anta unita 132 vetro+24 piena)  <b>2 ante chiuse H 72</b>                      4 doors                      2 glass doors H 156 (only PET frame)                      (joint glass door 132+full door 24)                      2 full doors H 72</p>	<p>telaio PET L 90 P 59,6                      PET frame</p>	E6211900	907	953			
 <p><b>1 anta vetro H 156 (solo telaio PET)</b>                      (anta unita 132 vetro+24 piena)  <b>4 cassetti H 18</b>                      1 glass door H 156 (only PET frame)                      (joint glass door 132+full door 24)                      4 drawers H 18</p>		<p>telaio PET L 45 P 59,6                      PET frame</p>	E6294451/2	739	779			
	 <p><b>1 anta vetro H 156 (solo telaio PET)</b>                      (anta unita 132 vetro+24 piena)  <b>2 cassetti H 18</b>  <b>1 cestone H 36</b>                      1 glass door H 156 (only PET frame)                      (joint glass door 132+full door 24)                      2 drawers H 18                      1 deep drawer H 36</p>	<p>telaio PET L 45 P 59,6                      PET frame</p>	E6294461/2	688	724			

# COLONNE H 241

COLUMNS H 241

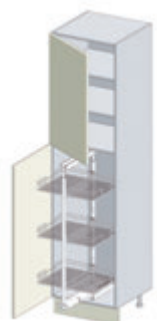
P 59,6

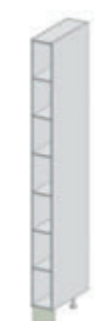
<b>N.B.: cassetti e cestoni ad estrazione totale con blumotion</b> Note: fully extending drawers and deep drawers with blumotion system		COD.	BRIDGE ALKOR- CELL KS1	BRIDGE PET KS1				
 <p><b>1 anta vetro H 156 (solo telaio PET)</b>                      (anta unita 132 vetro+24 piena)  <b>2 cestoni H 36</b>                      1 glass door H 156 (only PET frame)                      (joint glass door 132+full door 24)                      2 deep drawers H 36</p>								
	<p>telaio PET L 45 PET frame</p>	E6295451/2	638	670				
 <p><b>1 anta superiore H 96</b>  <b>1 anta H 132 integrata al gruppo cestelli estraibili in filo orion grau</b>  <b>chiusura soft</b>                      1 upper door H 96                      1 door H 132 incorporated into the orion grau wire                      pull-out basket units                      soft-closing system</p>								
	L 30	E617030A1/2	620	671				
 <p><b>1 anta superiore H 96</b>  <b>1 anta inferiore H 132 gruppo cestelli estraibili in filo orion grau</b>  <b>chiusura soft</b>                      1 upper door H 96                      1 lower door H 132 orion grau wire                      pull-out basket units                      soft-closing system</p>								
	L 45	E617045A1/2	662	725				
	L 60	E617060A1/2	729	804				
 <p><b>1 anta superiore H 96 (cerniere 100°)</b>  <b>1 anta inferiore H 132 (cerniere 180°)</b>  <b>1 cassetto interno</b>  <b>3 cestoni interni</b>                      posizionare sempre a 5 cm dalla parete laterale                      1 upper door H 96 (100° hinges)                      1 lower door H 132 (180° hinges)                      1 internal drawer                      3 internal deep drawers                      should always be placed at 5 cm from the side wall</p>								
	L 45	E608848A1/2	688	750				
 <p><b>jolly colonna folding</b>  <b>L da 15 a 30</b>                      folding jolly column                      size from 15 to 30</p>								
		colore come struttura same colour as carcass	E6003000	307	307			
		colore come anta alkorcell same colour as alkorcell door	E6003030	630	—			
	colore come anta PET same colour as PET door	E6003025	—	1.179				

# COLONNE ANGOLO H 241

P 59,6

CORNER COLUMNS H 241

**N.B.: cerniere ammortizzate di serie**  
Note: standard blumotion hinges



**angolo 5 ripiani con tirante centrale**  
1 anta superiore H 96  
1 anta inferiore H 132  
(cerniere a pilastro)  
**pannello come anta sp. 2,2**  
corner unit 5 shelves with central tie beam  
1 upper door H 96  
1 lower door H 132  
(pillar hinges)  
panel as door Th. 2,2

L 110  
L 125

COD.

BRIDGE  
ALKOR-  
CELL  
KS1

BRIDGE  
PET  
KS1

683

814

733

876



**angolo 1 anta H 228 (156+72) cerniere 135°**  
**2 fianchi sp. 3,8 come struttura**  
**N.B.: fornita smontata**  
corner 1 door H 228 (156+72) 135° hinges  
2 side panels Th.3,8 same as carcass  
**Note: supplied unassembled**

105,5x105,5

E6342051/2

1.063

1.138









# COLONNE PER FORNO H 109

P 59,6

OVEN COLUMNS H 109

**Le colonne non sono comprensive di top - N.B.: cassetti e cestoni ad estrazione totale con blumotion**  
The columns do not include the tops - Note: fully extending drawers and deep drawers with blumotion system

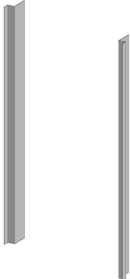





	COD.	BRIDGE ALKOR- CELL KS1	BRIDGE PET KS1				
 <p><b>colonna H 109 per forno</b> <b>2 cassetti H 18</b> oven column H 109 2 drawers H 18</p>	L 60	E6501660	310	328			
	 <p><b>colonna H 109 per forno</b> <b>1 cassetto H 12</b> <b>1 cassetto H 24</b> oven column H 109 1 drawer H 12 1 drawer H 24</p>	L 60	E6501650	325	344		
 <p><b>colonna H 109 per forno</b> <b>1 cestone chiuso H 36</b> oven column H 109 1 full deep drawer H 36</p>		L 60	E6501600	252	271		
	 <p><b>top H 1,8 come anta</b> <b>P 59,7 per colonne</b> worktop H 1,8 same as door D 59,7 for columns</p>						
<p><b>alkorcell al ml</b> alkorcell per lm</p>		TLM186A	83	—			
<p><b>PET al ml</b> PET per lm</p>		TLM186P	—	127			
<p><b>mag.griglia di areazione cad.</b> surcharge for ventilation grille each</p>		T9FGA	30	30			
 <p><b>profilo in acciaio a "L" per rifinire il ripiano del forno e microonde</b> L-shaped steel finishing profile for shelf of oven and microwave</p> 	L 60						
	<p><b>inox</b> stainless steel</p>	08660100	9	9			
	<p><b>nero</b> black</p>	08660101	9	9			
	<p><b>bianco</b> white</p>	08660102	9	9			
	L 90						
<p><b>inox</b> stainless steel</p>	08660105	12	12				
 <p><b>kit protezione fianchi per forno</b> protection kit sides for oven</p> 							
	<p><b>coppia</b> couple</p>	08630095	16	16			

# COLONNE PER FORNO H 145

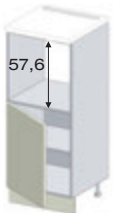
P 59,6

OVEN COLUMNS H 145

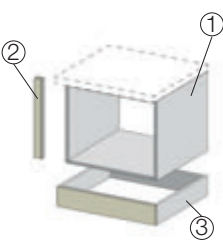
**Le colonne non sono comprensive di top - N.B.: cerniere ammortizzate di serie**  
The columns do not include the tops - Note: standard blumotion hinges







	COD.	BRIDGE ALKOR- CELL KS1	BRIDGE PET KS1				
 <p><b>colonna H 145 per forno 1 anta H 72</b> oven column H 145 1 door H 72</p>	L 60	E6520601/2	250	277			
	L 75	E6520751/2	303	334			
 <p><b>colonna H 145 per forno 4 cassetti H 18</b> oven column H 145 4 drawers H 18</p>	L 60	E6521610	502	540			
	L 60	E6521620	445	482			
 <p><b>colonna H 145 per forno 2 cassetti H 18 1 cestone H 36</b> oven column H 145 2 drawers H 18 1 deep drawer H 36</p>	L 60	E6521630	391	428			
	L 60	E6521630	391	428			
 <p><b>colonna H 145 per forno 2 cestoni H 36</b> oven column H 145 2 deep drawers H 36</p>	L 60	E6521630	391	428			
	L 60	E6521630	391	428			
 <p><b>colonna H 145 per forno per maxiforno H 48 1 cassetto H 18 2 ante H 60</b> oven column H 145 for maxi-oven H 48 1 drawer H 18 2 doors H 60</p>	L 90	E6521910	445	500			
	L 90	E6521910	445	500			
 <p><b>mobile H 60 L 65 per micro con fascia di tamponamento laterale e inferiore in appoggio su base angolo</b> unit H 60 W 65 flap door push-pull opening with lateral and lower filler panel resting on corser base unit</p> <p>verso sx LH version</p>		E2521600	119	129			
		E278000B	50	69			
		E2882100	57	77			
 <p><b>Esempio di mobile per micro in appoggio su base angolo con colonna H 132 affiancata</b> <b>Example</b> of micro unit resting on corser base unit with side by side column H 132</p> <p>verso sx LH version</p>							

# COLONNE PER FORNO H 217

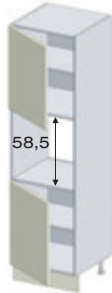
P 59,6

OVEN COLUMNS H 217

**N.B.: cassetti e cestoni ad estrazione totale con blumotion**  
 Note: fully extending drawers and deep drawers with blumotion system

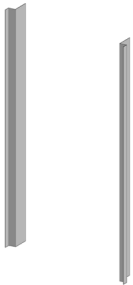

	COD.	BRIDGE ALKOR- CELL KS1	BRIDGE PET KS1				
 <p><b>colonna per forno</b>  <b>1 anta superiore H 72</b>  <b>1 anta inferiore H 72</b>                      oven column                      1 upper door H 72                      1 lower door H 72</p>	L 60	E653060A1/2	384	439			
	L 75	E653075A1/2	474	537			
 <p><b>colonna per forno</b>  <b>1 anta H 72</b>  <b>4 cassetti H 18</b>                      oven column                      1 door H 72                      4 drawers H 18</p>	L 60	E6531611/2	653	718			
 <p><b>colonna per forno</b>  <b>1 anta H 72</b>  <b>2 cassetti H 18</b>  <b>1 cestone H 36</b>                      oven column                      1 door H 72                      2 drawers H 18                      1 deep drawer H 36</p>	L 60	E6531621/2	596	661			
 <p><b>colonna per forno</b>  <b>1 anta H 72</b>  <b>2 cestoni H 36</b>                      oven column                      1 door H 72                      2 deep drawers H 36</p>	L 60	E6531631/2	539	603			
 <p><b>profilo in acciaio a "L" per rifinire il ripiano del forno e microonde</b>                      L-shaped steel finishing profile for shelf of oven and microwave</p> 	L 60						
	inox stainless steel	08660100	9	9			
	nero black	08660101	9	9			
	bianco white	08660102	9	9			
 <p><b>kit protezione fianchi per forno</b>                      protection kit sides for oven</p> 	coppia couple	08630095	16	16			

# COLONNE PER FORNO H 217

P 59,6

OVEN COLUMNS H 217

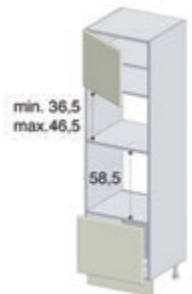
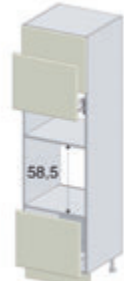
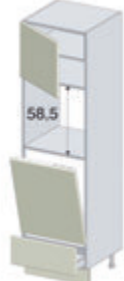
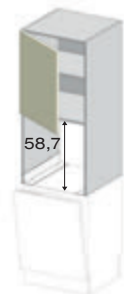
**N.B.: cassetti e cestoni ad estrazione totale con blumotion**  
 Note: fully extending drawers and deep drawers with blumotion system







	COD.	BRIDGE ALKOR- CELL KS1	BRIDGE PET KS1				
 <p><b>colonna per forno e micro</b>  <b>1 anta superiore H 48</b>  <b>vano micro da H 36,5 a 46,5</b>  <b>cestone H 48</b>                      oven and microwave column                      1 upper door H 48                      microwave compartment H 36,5 to 46,5                      deep drawer H 48</p>	L 60	E6551601/2	473	505			
 <p><b>colonna per forno</b>  <b>1 anta superiore H 48</b>  <b>1 anta H 48 sollevamento verticale</b>  <b>1 cestone H 48</b>                      oven column                      1 upper door H 48                      1 door H 48 vertical opening                      1 deep drawer H 48</p>	L 60	E655460A1/2	628	692			
 <p><b>colonna per forno e lavastoviglie</b>  <b>Electrolux KESC 5300L - AEG FSE 63307P</b>  <b>1 anta superiore H 48</b>  <b>1 anta lavastoviglie H 72</b>  <b>1 cassetto H 24</b>                      column for oven and Electrolux KESC 5300L                      AEG FSE 63307P dishwasher                      1 upper door H 48                      1 dishwasher door H 72                      1 drawer H 24</p>	L 60	E6573601/2	468	525			
 <p><b>colonna forno sospesa H 132 per lavastoviglie</b>  <b>1 anta H 72</b>                      hanging oven column H 132 for dishwasher                      1 door H 72</p>	L 60	E6576601/2	291	318			
 <p><b>fianco per elettrodomestici a fine composizione</b>                      side panel for appliances placed at the end of the composition</p>							
			<b>H 217x59,6x1,8 zoccolo H 13</b> <b>alkorcell come anta</b> alkorcell same as door				
		T94380	150	—			
		T94380	—	224			

# COLONNE PER FORNO H 241

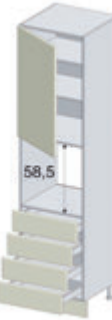
P 59,6

OVEN COLUMNS H 241

**N.B.: cassetti e cestoni ad estrazione totale con blumotion**  
 Note: fully extending drawers and deep drawers with blumotion system

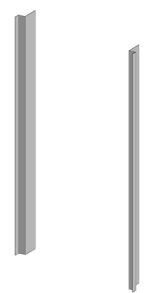

	COD.	BRIDGE ALKOR- CELL KS1	BRIDGE PET KS1				
 <p><b>colonna per forno</b>  <b>1 anta superiore H 96</b>  <b>1 anta inferiore H 72</b>                      oven column                      1 upper door H 96                      1 lower door H 72</p>	L 60	E654060A1/2	423	484			
 <p><b>colonna per forno</b>  <b>1 anta H 96</b>  <b>4 cassetti H 18</b>                      oven column                      1 door H 96                      4 drawers H 18</p>	L 60	E6541611/2	679	750			
 <p><b>colonna per forno</b>  <b>1 anta superiore H 96</b>  <b>2 cassetti H 18</b>  <b>1 cestone H 36</b>                      oven column                      1 upper door H 96                      2 drawers H 18                      1 deep drawer H 36</p>	L 60	E6541621/2	622	692			
 <p><b>colonna per forno</b>  <b>1 anta superiore H 96</b>  <b>2 cestoni H 36</b>                      oven column                      1 upper door H 96                      2 deep drawers H 36</p>	L 60	E6541631/2	565	635			
 <p><b>profilo in acciaio a "L" per rifinire il ripiano del forno e microonde</b>                      L-shaped steel finishing profile for shelf of oven and microwave</p> 	L 60						
		<b>inox</b> stainless steel	08660100	9	9		
		<b>nero</b> black	08660101	9	9		
		<b>bianco</b> white	08660102	9	9		
 <p><b>kit protezione fianchi per forno</b>                      protection kit sides for oven</p> 	coppia						
		<b>coppia</b> couple	08630095	16	16		

# COLONNE PER FORNO H 241

P 59,6

OVEN COLUMNS H 241

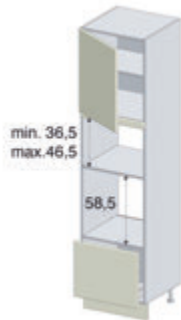
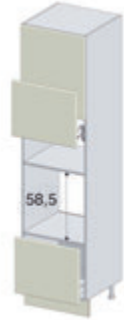
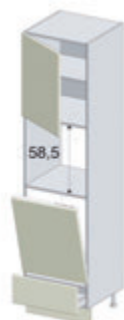
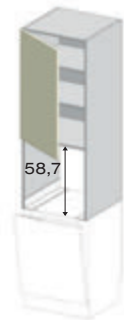
**N.B.: cassetti e cestoni ad estrazione totale con blumotion**  
 Note: fully extending drawers and deep drawers with blumotion system

	COD.	BRIDGE ALKOR- CELL KS1	BRIDGE PET KS1						
 <p><b>colonna per forno e micro</b>  <b>1 anta superiore H 72</b>  <b>vano micro da H 36,5 a 46,5</b>  <b>1 cestone H 48</b>                      oven and microwave column                      1 upper door H 72                      microwave compartment H 36,5 to 46,5                      1 deep drawer H 48</p>	L 60	E6561601/2	495	534					
 <p><b>colonna per forno</b>  <b>1 anta superiore H 72</b>  <b>1 anta H 48 sollevamento verticale</b>  <b>1 cestone H 48</b>                      oven column                      1 upper door H 72                      1 door H 48 vertical opening                      1 deep drawer H 48</p>	L 60	E656460A1/2	663	734					
 <p><b>colonna per forno e lavastoviglie</b>  <b>Electrolux KESC 5300L - AEG FSE 63307P</b>  <b>1 anta superiore H 72</b>  <b>1 anta lavastoviglie H 72</b>  <b>1 cassetto H 24</b>                      column for oven and Electrolux KESC 5300L                      AEG FSE 63307P dishwasher                      1 upper door H 72                      1 dishwasher door H 72                      1 drawer H 24</p>	L 60	E6575601/2	502	566					
 <p><b>colonna forno sospesa H 156 per lavastoviglie</b>  <b>1 anta H 96</b>                      hanging oven column H 156 for dishwasher                      1 door H 96</p>	L 60	E6577601/2	335	368					
 <p><b>fianco per colonna sospesa a fine composizione</b>                      side panel for hanging column placed at the end of the composition</p>									
			<b>H 241x59,6x1,8 zoccolo H 13</b> <b>alkorcell come anta</b> alkorcell same as door		T94386	162	—		
			<b>PET come anta</b> PET same as door		T94386	—	243		

# COLONNE PER FRIGO H 145 - 217

P 59,6

FRIDGE COLUMNS H 145 - 217

**Le colonne non sono comprensive di top**  
The columns do not include the tops

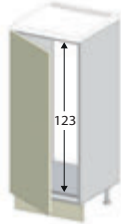
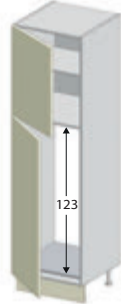
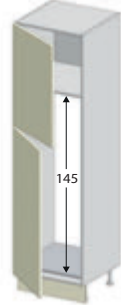
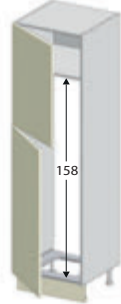
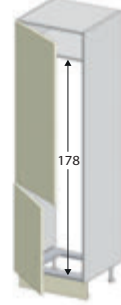
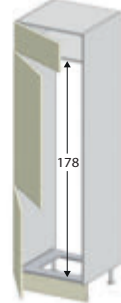
	COD.	BRIDGE ALKOR- CELL KS1	BRIDGE PET KS1				
 <p><b>colonna H 145 per frigo 215 monoporta</b> column H 145 for single-door fridge 215</p>							
L 60	E6452151/2	292	334				
 <p><b>colonna H 217 per frigo 215 monoporta</b> <b>1 anta superiore H 72</b> <b>1 anta inferiore H 132</b> column H 217 for 215 single-door fridge 1 upper door H 72 1 lower door H 132</p>							
L 60	E646215A1/2	385	455				
 <p><b>colonna H 217 per frigo-freezer 230</b> <b>1 anta superiore H 84</b> <b>1 anta inferiore H 120</b> column H 217 for 230 fridge-freezer 1 upper door H 84 1 lower door H 120</p>							
L 60	E646231A1/2	385	455				
 <p><b>colonna H 217 per frigo-freezer 280</b> <b>1 anta superiore H 84</b> <b>1 anta inferiore H 120</b> column H 217 for 280 fridge-freezer 1 upper door H 84 1 lower door H 120</p>							
L 60	E646286A1/2	385	455				
 <p><b>colonna H 217 per frigo-congelatore 315</b> <b>1 anta superiore H 132</b> <b>1 anta inferiore H 72</b> column H 217 for 315 fridge-freezer 1 upper door H 132 1 lower door H 72</p>							
L 60	E646315A1/2	385	455				
 <p><b>colonna H 217 per frigo-congelatore 315</b> <b>1 anta superiore H 24</b> <b>1 anta centrale H 108</b> <b>1 anta inferiore H 72</b> column H 217 for 315 fridge-freezer 1 upper door H 24 1 central door H 108 1 lower door H 72</p>							
L 60	E6463161/2	426	506				

# COLONNE PER FRIGO H 217

P 59,6

FRIDGE COLUMNS H 217

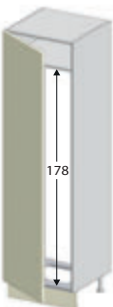
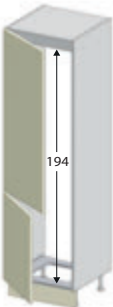
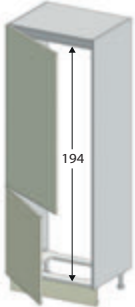



	COD.	BRIDGE ALKOR- CELL KS1	BRIDGE PET KS1				
 <p><b>colonna H 217 per frigo-congelatore 330</b>  <b>1 anta superiore H 132</b>  <b>1 anta inferiore H 72</b>                      column H 217 for 330 fridge-freezer                      1 upper door H 132                      1 lower door H 72</p>	L 60	E646330A1/2	385	455			
	 <p><b>colonna H 217 per frigo-freezer 300 monoporta</b>  <b>1 anta H 204</b>                      column H 217 for 300 single-door fridge-freezer                      1 door H 204</p>	L 60	E6463001/2	385	455		
 <p><b>colonna H 217 per frigo-congelatore 350</b>  <b>1 anta superiore H 132</b>  <b>1 anta inferiore H 72</b>                      column H 217 for 350 fridge-freezer                      1 upper door H 132                      1 lower door H 72</p>		L 60	E646351A1/2	385	455		
	 <p><b>colonna H 217 per frigo-congelatore 400</b>  <b>1 anta superiore H 132</b>  <b>1 anta inferiore H 72</b>                      column H 217 for 400 fridge-freezer                      1 upper door H 132                      1 lower door H 72</p>	L 75	E646400A1/2	478	560		

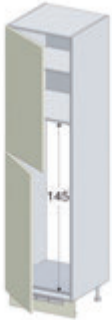
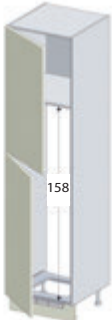

# COLONNE PER FRIGO H 241

FRIDGE COLUMNS H 241

P 59,6

	COD.	BRIDGE ALKOR- CELL KS1	BRIDGE PET KS1				
 <p><b>colonna H 241 per frigo 215 monoporta</b>  <b>1 anta superiore H 96</b>  <b>1 anta inferiore H 132</b>                      column H 241 for 215 single-door fridge                      1 upper door H 96                      1 lower door H 132</p>							
	L 60	E647215A1/2	406	482			
 <p><b>colonna H 241 per frigo-freezer 230</b>  <b>1 anta superiore H 108</b>  <b>1 anta inferiore H 120</b>                      column H 241 for 230 fridge-freezer                      1 upper door H 108                      1 lower door H 120</p>							
	L 60	E647231A1/2	406	482			
 <p><b>colonna H 241 per frigo-freezer 280</b>  <b>1 anta superiore H 108</b>  <b>1 anta inferiore H 120</b>                      column H 241 for 280 fridge-freezer                      1 upper door H 108                      1 lower door H 120</p>							
	L 60	E647286A1/2	406	482			
 <p><b>colonna H 241 per frigo-congelatore 315</b>  <b>1 anta superiore H 156</b>  <b>1 anta inferiore H 72</b>                      column H 241 for 315 fridge-freezer                      1 upper door H 156                      1 lower door H 72</p>							
	L 60	E647315A1/2	406	482			
 <p><b>colonna H 241 per frigo-congelatore 315</b>  <b>1 anta superiore H 48</b>  <b>1 anta centrale H 108</b>  <b>1 anta inferiore H 72</b>                      column H 241 for 315 fridge-freezer                      1 upper door H 48                      1 central door H 108                      1 lower door H 72</p>							
	L 60	E6473161/2	450	536			
 <p><b>colonna H 241 per frigo-congelatore 330</b>  <b>1 anta superiore H 156</b>  <b>1 anta inferiore H 72</b>                      column H 241 for 330 fridge-freezer                      1 upper door H 156                      1 lower door H 72</p>							
	L 60	E647330A1/2	406	482			

# COLONNE PER FRIGO H 241

P 59,6

FRIDGE COLUMNS H 241

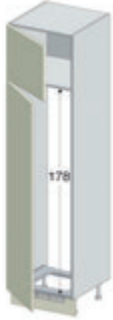
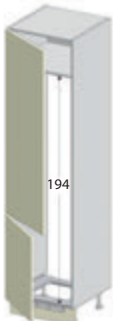
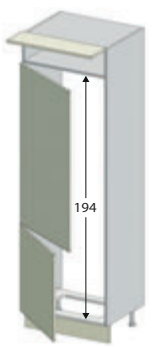
	COD.	BRIDGE ALKOR- CELL KS1	BRIDGE PET KS1				
 <p><b>colonna H 241 per frigo-congelatore 330</b>  <b>1 anta superiore H 36</b>  <b>1 anta centrale H 120</b>  <b>1 anta inferiore H 72</b>                      column H 241 for 330 fridge-freezer                      1 upper door H 36                      1 central door H 120                      1 lower door H 72</p>	L 60	E6473361/2	450	536			
 <p><b>colonna H 241 per frigo-congelatore 300</b>  <b>monoporta</b>  <b>1 anta superiore H 48</b>  <b>1 anta inferiore H 180</b>                      column H 241 for 300 single-door fridge-freezer                      1 upper door H 48                      1 lower door H 180</p>	L 60	E647300A1/2	450	529			
 <p><b>colonna H 241 per frigo-congelatore 350</b>  <b>1 anta superiore H 156</b>  <b>1 anta inferiore H 72</b>                      column H 241 for 350 fridge-freezer                      1 upper door H 156                      1 lower door H 72</p>	L 60	E647351A1/2	406	482			
 <p><b>colonna H 241 per frigo-congelatore 400</b>  <b>1 anta superiore a ribalta H 24 TIP-ON</b>  <b>1 anta centrale H 132</b>  <b>1 anta inferiore H 72</b>                      column H 241 for 400 fridge-freezer                      1 upper flap door H 24 TIP-ON opening                      1 central door H 132                      1 lower door H 72</p>	L 75	E6474101/2	631	730			

# TERMINALI A GIORNO LACCATO OPACO PER ISOLA E PENISOLA

MATT LACQUERED ISLAND AND PENINSULA OPEN END UNITS

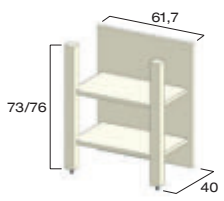
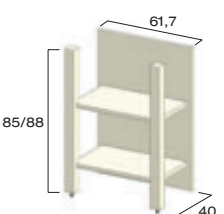
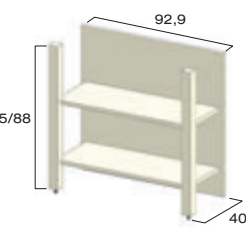
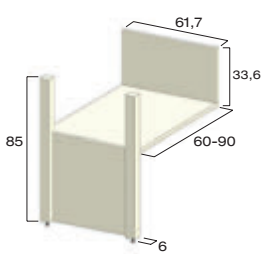
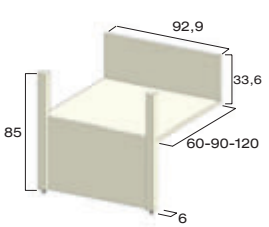

**VEDI CATALOGO FINITURE LACCATE (GRUPPO LUBE)**  
SEE LACQUERED FINISHES CATALOGUE (GRUPPO LUBE)

		COD.	€				
 <p><b>terminale a giorno laccato opaco per isola ribassata</b> matt lacquered open end unit for lowered island</p>	<b>NECK</b>						
	<b>L 61,7 H 76 P 40</b>	ETB00520	470				
	<b>BRIDGE</b>						
	<b>L 61,7 H 73 P 40</b>	ETB00515	465				
 <p><b>terminale a giorno laccato opaco</b> matt lacquered open end unit</p>	<b>NECK</b>						
	<b>L 61,7 H 88 P 40</b>	ETB00620	490				
	<b>BRIDGE</b>						
	<b>L 61,7 H 85 P 40</b>	ETB00615	479				
 <p><b>terminale a giorno laccato opaco</b> matt lacquered open end unit</p>	<b>NECK</b>						
	<b>L 92,9 H 88 P 40</b>	ETB00640	531				
	<b>BRIDGE</b>						
	<b>L 92,9 H 85 P 40</b>	ETB00635	517				
 <p><b>terminale a giorno laccato opaco da inserire in appoggio con base H 49</b> matt lacquered open end unit to be inserted in support with base unit H 49</p>	<b>BRIDGE</b>						
	<b>L 61,7 H 85 P 66</b>	ETB00715	364				
	<b>L 61,7 H 85 P 96</b>	ETB00717	414				
 <p><b>terminale a giorno laccato opaco da inserire in appoggio con base H 49</b> matt lacquered open end unit to be inserted in support with base unit H 49</p>	<b>BRIDGE</b>						
	<b>L 92,9 H 85 P 66</b>	ETB00741	480				
	<b>L 92,9 H 85 P 96</b>	ETB00743	552				
	<b>L 92,9 H 85 P 126</b>	ETB00745	639				

# TERMINALI CON ANTE VETRO E VANI A GIORNO

P 59,6

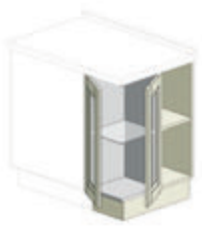

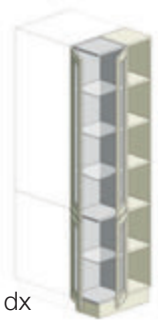
END UNITS WITH GLASS DOORS AND OPEN COMPARTMENTS

	COD.	NECK ALKOR- CELL KS2	NECK PET KS2	BRIDGE ALKOR- CELL KS1	BRIDGE PET KS1		
 <p><b>terminale L 30 H 85 con ante vetro ripiano vetro (portata max.10 kg) elemento a giorno in folding come anta</b> end unit W 30 H 85 with glass doors glass shelf (max.load capacity 10 kg) folding open unit same colour as door</p> <p><b>L 30 H 85 piedini H 13</b> feet H 13</p> <p><b>telaio alkorcell</b> alkorcell frame</p> <p><b>telaio PET</b> PET frame</p> <p>verso dx RH version</p>	E4663301/2	—	—	535	—		
	E4663303/4	—	—	—	660		
	E4663301/2	—	—	586	—		
	E4663303/4	—	—	—	711		
 <p><b>terminale L 30 H 145 con ante vetro ripiani vetro (portata max.10 kg) elemento a giorno in folding come anta</b> end unit W 30 H 145 with glass doors glass shelves (max.load capacity 10 kg) folding open unit same colour as door <b>apertura push-pull per versione Neck</b> <b>push pull opening for Neck version</b></p> <p><b>L 30 H 145 piedini H 13</b> feet H 13</p> <p><b>telaio alkorcell</b> alkorcell frame</p> <p><b>telaio PET</b> PET frame</p> <p>verso dx RH version</p>	E6376301/2	816	—	806	—		
	E6376303/4	—	1.047	—	1.037		
	E6376301/2	889	—	879	—		
	E6376303/4	—	1.120	—	1.110		
 <p><b>terminale L 30 H 217 con ante vetro ripiani vetro (portata max.10 kg) elemento a giorno in folding come anta</b> end unit W 30 H 217 with glass doors glass shelves (max.load capacity 10 kg) folding open unit same colour as door <b>apertura push-pull per versione Neck</b> <b>push pull opening for Neck version</b></p> <p><b>L 30 H 217 piedini H 13</b> feet H 13</p> <p><b>telaio alkorcell</b> alkorcell frame</p> <p><b>telaio PET</b> PET frame</p> <p>verso dx RH version</p>	E6376311/2	1.162	—	1.142	—		
	E6376313/4	—	1.511	—	1.491		
	E6376311/2	1.286	—	1.266	—		
	E6376313/4	—	1.635	—	1.615		

TERMINALI A GIORNO  
OPEN END UNITS

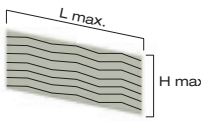

# FIANCHI DI FINITURA

FINISHING SIDE PANELS

	COD.	NECK ALKOR- CELL KS2	NECK PET KS2	BRIDGE ALKOR- CELL KS1	BRIDGE PET KS1			
<p>maggiorazione per fianchi di struttura come anta (cadauno) venatura verticale e tinta unita surcharge for carcass sides same finish as door (each) vertical grain and full colour</p> 	<b>PENSILE</b> WALL UNIT							
	36x31	24	29	24	29			
	48x31	26	34	26	34			
	60x31	29	38	29	38			
	72x31	34	42	34	42			
	96x31	40	51	40	51			
	120x31	42	58	42	58			
	132x31	45	70	45	70			
	<b>BASE NECK</b> NECK BASE UNIT							
	37,5x57,5	30	42	—	—			
	51x57,5	33	51	—	—			
	63x57,5	36	56	—	—			
	75x57,5	39	63	—	—			
	<b>BASE BRIDGE</b> BRIDGE BASE UNIT							
	36x57,5	—	—	30	42			
	48x57,5	—	—	33	51			
	60x57,5	—	—	36	56			
	72x57,5	—	—	39	63			
	<b>COLONNA</b> COLUMN							
	132x31	45	70	45	70			
	204x31	55	110	55	110			
	228x31	63	122	63	122			
	96x57,5	47	73	47	73			
	132x57,5	58	93	58	93			
	204x57,5	83	141	83	141			
	228x57,5	91	155	91	155			
	 <p><b>pannello di finitura SP. 1,8 finitura come anta (venature verticali per finiture legno)</b> <b>N.B.: quantità minima fatturabile 0,3 mq</b> finishing panel TH. 1,8 same finish as door (vertical grains for wood finishes) <b>Note: 0,3 square meter, min.quantity that can be invoiced</b></p>	<b>al mq</b> per m <sup>2</sup>						
		<b>L max.110 H max.275 alkorcell</b> W max.110 H max.275 alkorcell	094571V	184	—	184	—	
		<b>L max.88 H max.241 PET</b> W max.88 H max.241 PET	0945639V	—	202	—	202	
	 <p><b>pannello di finitura SP. 1,8 finitura come anta (venature orizzontali per finiture legno)</b> <b>N.B.: quantità minima fatturabile 0,3 mq</b> finishing panel TH. 1,8 same finish as door (horizontal grains for wood finishes) <b>Note: 0,3 square meter, min.quantity that can be invoiced</b></p>	<b>al mq</b> per m <sup>2</sup>						
		<b>L max.275 H max.110 alkorcell</b> W max.275 H max.110 alkorcell	094571	184	—	184	—	
		<b>L max.241 H max.88 PET</b> W max.241 H max.88 PET	0945639	—	202	—	202	

# ANTE DI FINITURA LATERALI versione Neck



LATERAL FINISHING DOORS Neck version

	COD.	NECK ALKOR- CELL KS2	NECK PET KS2				
<p><b>ante di finitura laterali sp. 1,8 (anta liscia)</b> lateral finishing doors th. 1,8 (smooth door)</p> 	<b>PENSILE</b> WALL UNIT						
	H 36 (35,7x33,1)	1KS24045	28	42			
	H 48 (47,7x33,1)	1KS24046	32	48			
	H 60 (59,7x33,1)	1KS24047	36	54			
	H 72 (71,7x33,1)	1KS2405	39	59			
	H 96 (95,7x33,1)	1KS2406	48	71			
	H 120 (119,7x33,1)	1KS2407	58	85			
	H 132 (131,7x33,1)	1KS2408	62	91			
	<p><b>ante di finitura laterali sp. 1,8 (anta liscia)</b> <b>senza gola</b> lateral finishing doors th. 1,8 (smooth door) <b>without finger rail</b></p> 	<b>BASE</b> BASE UNIT					
H 50,5 (37,2x59,6)		1KS23952	38	57			
H 64 (50,7x59,6)		1KS23963	46	69			
H 76 (62,7x59,6)		1KS23983	52	78			
H 88 (74,7x59,6)		1KS24003	60	90			
<b>ISOLA</b> ISLAND							
H 76 (62,7x61,4)		1KS24023	54	81			
H 88 (74,7x61,4)		1KS24033	62	93			
H 88 (74,7x92,4)		1KS24034	88	129			
<b>COLONNA</b> COLUMN							
H 145 (131,7x33,1)		1KS2408	62	91			
H 217 (203,7x33,1)		1KS24112	84	139			
H 241 (227,7x33,1)		1KS24122	97	156			
H 109 (95,7x59,6)		1KS2409	73	107			
H 145 (131,7x59,6)		1KS2410	94	140			
H 217 (203,7x59,6)		1KS2411	160	240			
H 241 (227,7x59,6)		1KS2412	160	240			

ANTE DI FINITURA  
 MENSOLE  
 FINISHING DOORS - SHELVES

# ANTE DI FINITURA LATERALI versione Bridge

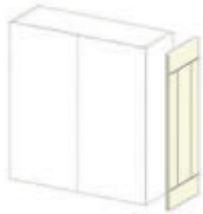
LATERAL FINISHING DOORS Bridge version



	COD.	BRIDGE ALKOR- CELL KS1	BRIDGE PET KS1				
<p><b>ante di finitura laterali sp. 1,8 (anta a telaio)</b> lateral finishing doors th. 1,8 (framed door)</p> 							
	<b>PENSILE</b> WALL UNIT						
	H 36 (35,7x33,1)	1KS14045	46	64			
	H 48 (47,7x33,1)	1KS14046	50	70			
	H 60 (59,7x33,1)	1KS14047	53	75			
	H 72 (71,7x33,1)	1KS1405	56	80			
	H 96 (95,7x33,1)	1KS1406	64	92			
	H 120 (119,7x33,1)	1KS1407	74	111			
H 132 (131,7x33,1)	1KS1408	76	115				
<p><b>ante di finitura laterali sp. 1,8 (anta a telaio)</b> lateral finishing doors th. 1,8 (framed door)</p> 							
	<b>BASE</b> BASE UNIT						
	H 49 (35,7x59,6)	1KS1395	54	75			
	H 61 (47,7x59,6)	1KS1396	60	84			
	H 73 (59,7x59,6)	1KS1398	65	93			
	H 85 (71,7x59,6)	1KS1400	70	101			
	<b>ISOLA</b> ISLAND						
	H 73 (59,7x61,4)	1KS1402	69	99			
	H 85 (71,7x61,4)	1KS1403	71	105			
	H 85 (71,7x92,4)	1KS14031	90	133			
	<b>COLONNA</b> COLUMN						
	H 145 (131,7x33,1)	1KS1408	76	115			
	H 217 (203,7x33,1)	1KS14112	138	198			
	H 241 (227,7x33,1)	1KS14122	155	222			
	H 109 (95,7x59,6)	1KS1409	82	121			
	H 145 (131,7x59,6)	1KS1410	98	151			
H 217 (203,7x59,6)	1KS1411	199	277				
H 241 (227,7x59,6)	1KS1412	199	277				

# ANTE DI FINITURA POSTERIORI

## REAR FINISHING DOORS

\*Per il codice sostituire le XXX con il codice della versione corrispondente

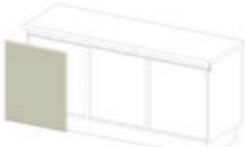















\*Replace XXX with the concerning code version

	*COD.	NECK ALKOR- CELL KS2	NECK PET KS2	BRIDGE ALKOR- CELL KS1	BRIDGE PET KS1			
<p><b>ante di finitura posteriori versione Neck</b> <b>senza gola</b> rear finishing doors Neck version <b>without finger rail</b></p> 	<b>BASE NECK</b>							
	NECK BASE UNIT							
	L 45 (62,7x44,7)	1XXX4243	71	96	—	—		
	L 60 (62,7x59,7)	1XXX4263	78	106	—	—		
	L 90 (62,7x89,7)	1XXX4283	94	130	—	—		
	L 30 (74,7x29,7)	1XXX4303	68	90	—	—		
	L 40 (74,7x39,7)	1XXX4323	74	102	—	—		
	L 45 (74,7x44,7)	1XXX4343	79	105	—	—		
	L 60 (74,7x59,7)	1XXX4363	85	115	—	—		
	L 90 (74,7x89,7)	1XXX4403	105	146	—	—		
	<b>BASE ANGOLO NECK</b>							
	NECK CORNER BASE UNIT							
	L 65 (74,7x64,7)	1XXX4383	88	120	—	—		
<p><b>ante di finitura posteriori per basi uso penisola-isola versione Neck</b> <b>con gola</b> rear finishing doors for base units used as peninsula-island Neck version <b>with finger rail</b></p> 	<b>BASE NECK</b>							
	NECK BASE UNIT							
	L 45 (59,7x44,7)	1XXX424	82	107	—	—		
	L 60 (59,7x59,7)	1XXX426	92	120	—	—		
	L 90 (59,7x89,7)	1XXX428	115	151	—	—		
	L 30 (71,7x29,7)	1XXX430	75	97	—	—		
	L 40 (71,7x39,7)	1XXX432	84	113	—	—		
	L 45 (71,7x44,7)	1XXX434	90	116	—	—		
	L 60 (71,7x59,7)	1XXX436	99	129	—	—		
	L 90 (71,7x89,7)	1XXX440	126	167	—	—		
	<b>BASE ANGOLO NECK</b>							
	NECK CORNER BASE UNIT							
	L 65 (71,7x64,7)	1XXX438	103	135	—	—		
<p><b>ante di finitura posteriori per basi uso penisola-isola versione Bridge</b> rear finishing doors for base units used as peninsula-island Bridge version</p> 	<b>BASE BRIDGE</b>							
	BRIDGE BASE UNIT							
	L 45 (59,7x44,7)	1XXX424	—	—	71	96		
	L 60 (59,7x59,7)	1XXX426	—	—	78	106		
	L 90 (59,7x89,7)	1XXX428	—	—	94	130		
	L 30 (71,7x29,7)	1XXX430	—	—	68	90		
	L 40 (71,7x39,7)	1XXX432	—	—	74	103		
	L 45 (71,7x44,7)	1XXX434	—	—	79	105		
	L 60 (71,7x59,7)	1XXX436	—	—	85	115		
	L 90 (71,7x89,7)	1XXX440	—	—	105	146		
	<b>BASE ANGOLO BRIDGE</b>							
	BRIDGE CORNER BASE UNIT							
	L 65 (71,7x64,7)	1XXX438	—	—	88	120		

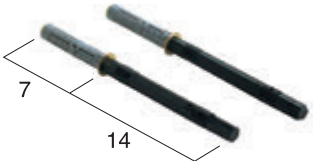

# MENSOLE





SHELVES

	COD.	€		COD.	€		
<p><b>mensola sp. 3,8 in nobilitato colori come strutture</b>  <b>L max cm 400</b>                      laminate shelf th. 3.8 carcasses colours                      max. length 400 cm</p>  <div style="display: flex; justify-content: space-around;"> <div style="text-align: center;">                       bianco (opz.001) white                 </div> <div style="text-align: center;">                       conchiglia (opz.8910) shell                 </div> </div> <div style="display: flex; justify-content: space-around; margin-top: 10px;"> <div style="text-align: center;">                       fango (opz.8860) mud                 </div> <div style="text-align: center;">                       lavagna (opz.9620) slate grey                 </div> </div> <div style="display: flex; justify-content: space-around; margin-top: 10px;"> <div style="text-align: center;">                       visone (opz.948M) mink                 </div> <div style="text-align: center;">                       argilla (opz.9690) clay                 </div> </div> <p style="text-align: right; margin-top: 20px;"><b>prezzi al ml</b> prices per lm</p> <p style="text-align: right;"><b>P 31</b></p> <p style="text-align: right;"><b>P 61</b></p>			<p><b>mensola sp. 3,8 in alkorcell come anta</b>  <b>L max cm 270</b>                      alkorcell shelf th. 3.8 same as door                      max. length 270 cm</p>  <div style="display: flex; justify-content: space-around; margin-top: 10px;"> <div style="text-align: center;">                       frassino bianco alpino (opz.2310) alpine-white ash                 </div> <div style="text-align: center;">                       rovere greige (opz.2320) greige oak                 </div> <div style="text-align: center;">                       betulla (opz.2311) birch                 </div> </div> <p style="text-align: right; margin-top: 20px;"><b>prezzi al ml</b> prices per lm</p> <p style="text-align: right;"><b>P 31</b></p> <p style="text-align: right;"><b>P 61</b></p>				
<p><b>reggimensola a scomparsa</b>                      fully integrated shelf bracket</p>  <p style="text-align: right; margin-top: 20px;"><b>cadauno</b> each</p>			<p><b>mensola sp. 3,8 in PET come anta</b>  <b>L max cm 270</b>                      PET shelf th. 3.8 same as door                      max. length 270 cm</p>  <div style="display: flex; justify-content: space-around; margin-top: 10px;"> <div style="text-align: center;">                       gesso supermatt (opz.7464) super-matt gypsum                 </div> <div style="text-align: center;">                       sahara supermatt (opz.7717) super-matt sahara                 </div> <div style="text-align: center;">                       luna supermatt (opz.9610) super-matt moon                 </div> </div> <div style="margin-top: 10px;"> <div style="text-align: center;">                       carbone supermatt (opz.9613) super-matt carbon                 </div> </div> <p style="text-align: right; margin-top: 20px;"><b>prezzi al ml</b> prices per lm</p> <p style="text-align: right;"><b>P 31</b></p> <p style="text-align: right;"><b>P 61</b></p>				

# BASI E COLONNE PER FORNO MERCATO U.S.A.

P 63,1

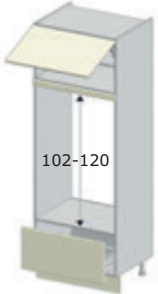
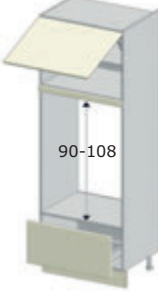
BASE AND COLUMNS UNITS CONFIGURED FOR OVEN FOR U.S. MARKET PLACE





		COD.	NECK ALKOR- CELL KS2	NECK PET KS2			
 <p><b>base per forno H 88</b>  <b>1 fascia superiore</b>  <b>staffe inferiori</b>  <b>fianco H 75 P 61</b>  <b>senza gola</b>                      oven base unit H 88                      1 upper panel                      lower brackets                      side H 75 D 61                      without finger rail</p>							
	L 76,2	USABF7577	184	197			
 <p><b>base per forno H 89,2</b>  <b>1 fascia superiore</b>  <b>staffe inferiori</b>  <b>fianco H 76,2 P 61</b>  <b>senza gola</b>                      oven base unit H 89,2                      1 upper panel                      lower brackets                      side H 76,2 D 61                      without finger rail</p>							
	L 76,2	USABF7777	184	197			
 <p><b>colonna per doppio forno H 217</b>  <b>1 anta ribalta TIP-ON H 36</b>  <b>1 fascia superiore</b>  <b>1 ripiano smontato</b>  <b>1 cestone TIP-ON H 36</b>                      double oven column H 217                      1 flap door TIP-ON H 36                      1 upper band                      1 disassembled shelf                      1 deep drawer TIP-ON H 36</p>							
	L 76,2	USACF204C3	640	649			
 <p><b>colonna per doppio forno H 217</b>  <b>1 anta ribalta TIP-ON H 48</b>  <b>1 fascia superiore</b>  <b>1 ripiano smontato</b>  <b>1 cestone TIP-ON H 36</b>                      double oven column H 217                      1 flap door TIP-ON H 48                      1 upper band                      1 disassembled shelf                      1 deep drawer TIP-ON H 36</p>							
	L 76,2	USACF204C4	649	659			
 <p><b>colonna per doppio forno H 217</b>  <b>1 anta ribalta TIP-ON H 60</b>  <b>1 fascia superiore</b>  <b>1 ripiano smontato</b>  <b>1 cestone TIP-ON H 36</b>                      double oven column H 217                      1 flap door TIP-ON H 60                      1 upper band                      1 disassembled shelf                      1 deep drawer TIP-ON H 36</p>							
	L 76,2	USACF204C6	721	733			
 <p><b>colonna per doppio forno H 241</b>  <b>1 anta ribalta TIP-ON H 60</b>  <b>1 fascia superiore</b>  <b>1 ripiano smontato</b>  <b>1 cestone TIP-ON H 36</b>                      double oven column H 241                      1 flap door TIP-ON H 60                      1 upper band                      1 disassembled shelf                      1 deep drawer TIP-ON H 36</p>							
	L 76,2	USACF228C6	733	745			

MERCATO U.S.A.  
U.S. MARKET

# BASI E COLONNE PER FORNO MERCATO U.S.A.

P 63,1

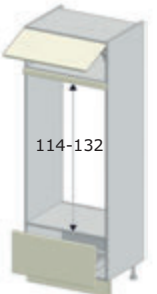
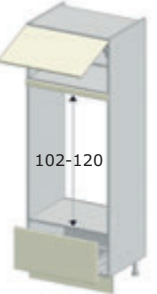
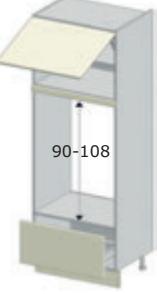
BASE AND COLUMNS UNITS CONFIGURED FOR OVEN FOR U.S. MARKET PLACE

		COD.	BRIDGE ALKOR- CELL KS1	BRIDGE PET KS1			
 <p><b>base per forno H 85</b> <b>staffe inferiori</b> <b>fianco H 72 P 61</b> oven base unit H 85 lower brackets side H 72 D 61</p> <p>68,5-72,7</p>							
	L 76,2	USABF7277	181	181			
 <p><b>base per forno H 89,2</b> <b>1 fascia superiore</b> <b>staffe inferiori</b> <b>fianco H 76,2 P 61</b> oven base unit H 89,2 1 upper panel lower brackets side H 76,2 D 61</p> <p>71,7-73,9</p>							
	L 76,2	USABF7777	184	197			
 <p><b>colonna per doppio forno H 217</b> <b>1 anta ribalta TIP-ON H 36</b> <b>1 fascia superiore</b> <b>1 ripiano smontato</b> <b>1 cestone H 36</b> double oven column H 217 1 flap door TIP-ON H 36 1 upper band 1 disassembled shelf 1 deep drawer H 36</p> <p>114-132</p>							
	L 76,2	USACF204C3	640	649			
 <p><b>colonna per doppio forno H 217</b> <b>1 anta ribalta TIP-ON H 48</b> <b>1 fascia superiore</b> <b>1 ripiano smontato</b> <b>1 cestone H 36</b> double oven column H 217 1 flap door TIP-ON H 48 1 upper band 1 disassembled shelf 1 deep drawer H 36</p> <p>102-120</p>							
	L 76,2	USACF204C4	649	659			
 <p><b>colonna per doppio forno H 217</b> <b>1 anta ribalta TIP-ON H 60</b> <b>1 fascia superiore</b> <b>1 ripiano smontato</b> <b>1 cestone H 36</b> double oven column H 217 1 flap door TIP-ON H 60 1 upper band 1 disassembled shelf 1 deep drawer H 36</p> <p>90-108</p>							
	L 76,2	USACF204C6	721	733			
 <p><b>colonna per doppio forno H 243</b> <b>1 anta ribalta TIP-ON H 60</b> <b>1 fascia superiore</b> <b>1 ripiano smontato</b> <b>1 cestone H 36</b> double oven column H 241 1 flap door TIP-ON H 60 1 upper band 1 disassembled shelf 1 deep drawer H 36</p> <p>114-132</p>							
	L 76,2	USACF228C6	733	745			

# SOPRACOLONNE APERTURA TIP-ON MERCATO U.S.A.

P 63,1

TOP COLUMNS TIP-ON OPENING FOR U.S. MARKET PLACE

**N.B.: per la versione Lux l'anta verrà realizzata sempre senza profilo**  
 Note: door realized without profile for the Lux version

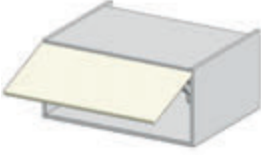
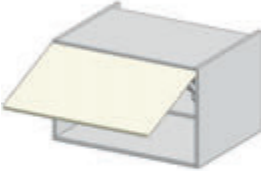
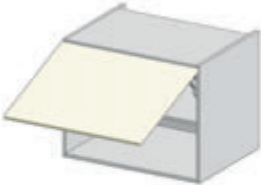
	COD.	NECK ALKOR- CELL KS2	NECK PET KS2	BRIDGE ALKOR- CELL KS1	BRIDGE PET KS1		
<b>1 anta ribalta H 36</b> 1 flap door H 36 	L 76,2	USASC3677C	286	290	286	290	
	L 91,4	USASC3692C	291	297	291	297	
<b>1 anta ribalta H 48</b> <b>1 ripiano</b> 1 flap door H 48 1 shelf 	L 76,2	USASC4877C	341	347	341	347	
	L 91,4	USASC4892C	355	361	355	361	
<b>1 anta ribalta H 60</b> <b>1 ripiano</b> 1 flap door H 60 1 shelf 	L 76,2	USASC6077C	411	418	411	418	

# LIVING

Spazi coordinati per avere un solo ambiente per cucinare, ricevere gli amici, pranzare e rilassarsi è una soluzione al desiderio di vivere la casa più liberamente, secondo stili di vita contemporanei, integrando cucina e living all'insegna di un nuovo linguaggio progettuale.

Coordinated spaces that create a single environment in which to cook, receive friends and relax is a solution that allows you to experience the home more freely.





In line with contemporary lifestyles, this solution integrates the kitchen and living area to create a new design language

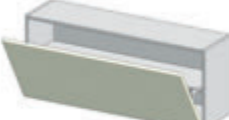

# PENSILI LIVING

LIVING AREA WALL UNITS

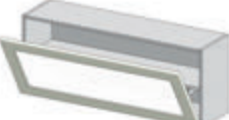
P 33,1

Per la modulistica completa dei pensili P 33,1 consultare la sezione "Pensili" For complete modularity of wall units D 33,1 see "Wall units" section		COD.	NECK ALKOR- CELL KS2	NECK PET KS2	BRIDGE ALKOR- CELL KS1	BRIDGE PET KS1		
 <p><b>pensile H 36</b> apertura a vasistas con push-pull (opz.996) wall unit H 36 flap door with push-pull opening (code 996)</p>	L 60	E2106600	175	193	175	193		
	L 90	E2106900	268	292	268	292		
	L 120	E2107200	300	328	300	328		
 <p><b>pensile H 48</b> apertura a vasistas con push-pull (opz.996) wall unit H 48 flap door with push-pull opening (code 996)</p>	L 60	E2123600	256	277	256	277		
	L 90	E2123900	280	308	280	308		
	L 120	E2124200	318	352	318	352		
 <p><b>pensile H 36</b> anta vetro apertura a vasistas con push-pull (opz.996) wall unit H 36 glass door flap door with push-pull opening (code 996)</p>	L 60	E1106600	196	217	196	217		
	L 90	E1106900	288	313	288	313		
 <p><b>pensile H 48</b> anta vetro apertura a vasistas con push-pull (opz.996) wall unit H 48 glass door flap door with push-pull opening (code 996)</p>	L 60	E1126600	278	308	278	308		
	L 90	E1126900	326	366	326	366		
 <p><b>mensola in appoggio per pensile</b> finitura come anta support shelf for wall unit same finish as door</p>								
		P 33,2 sp.1,8 al ml D 33,2 th.1,8 per lm						
		alkorcell L max 270 PET L max 240	TLM183A TLM183P	55 —	— 78	55 —	— 78	
 <p><b>maggiorazione per fianchi di struttura</b> come anta (cadauno) surcharge for carcass sides same finish as door (each)</p>								
		PENSILE WALL UNIT						
		36X31 48X31		+24 +26	+29 +34	+24 +26	+29 +34	





LIVING  
LIVING AREA

# BASI LIVING con piedi H 2,5

LIVING AREA BASE UNITS with feet H 2,5

H 22,7 - 40 - 53,5 P 50,1





**Le basi non sono comprensive di top - N.B.: cerniere ammortizzate di serie**  
The base units do not include the tops - Note: standard blumotion hinges

	COD.	NECK ALKOR- CELL KS2	NECK PET KS2				
 <p><b>base H 22,7</b> <b>1 cassetto H 16,9</b> base unit H 22,7 1 drawer H 16,9</p>	L 45	GBL03450	195	205			
	L 60	GBL03600	210	221			
	L 90	GBL03900	240	253			
	L 120	GBL04200	315	331			
 <p><b>base H 40</b> <b>1 anta H 34,2</b> base unit H 40 1 door H 34,2</p>	L 45	GBL21451/2	150	166			
	L 60	GBL21601/2	160	178			
 <p><b>base H 40</b> <b>2 ante H 34,2</b> base unit H 40 2 doors H 34,2</p>	L 90	GBL21900	238	269			
	L 120	GBL22200	277	313			
 <p><b>base H 40</b> <b>1 cestone H 34,2</b> base unit H 40 1 deep drawer H 34,2</p>	L 45	GBL25450	204	220			
	L 60	GBL25600	233	251			
	L 90	GBL25900	265	287			
	L 120	GBL26200	311	338			
 <p><b>base H 40</b> <b>2 cassetti H 16,9</b> base unit H 40 2 drawers H 16,9</p>	L 45	GBL23450	254	274			
	L 60	GBL23600	275	297			
	L 90	GBL23900	323	350			
	L 120	GBL24200	382	413			
 <p><b>base H 53,5</b> <b>1 anta H 47,7</b> base unit H 53,5 1 door H 47,7</p>	L 45	GBL31451/2	188	206			
	L 60	GBL31601/2	201	223			

# BASI LIVING con piedi H 2,5

H 53,5 P 50,1

LIVING AREA BASE UNITS with feet H 2,5

Le basi non sono comprensive di top - N.B.: cerniere ammortizzate di serie The base units do not include the tops - Note: standard blumotion hinges		COD.	NECK ALKOR- CELL KS2	NECK PET KS2				
 <p><b>base H 53,5</b> <b>2 ante H 47,7</b> base unit H 53,5 2 doors H 47,7</p>	L 90	GBL31900	290	327				
	L 120	GBL32200	351	394				
 <p><b>base H 53,5</b> <b>1 cestone H 47,7</b> base unit H 53,5 1 deep drawer H 47,7</p>	L 45	GBL35450	227	246				
	L 60	GBL35600	257	279				
	L 90	GBL35900	294	321				
	L 120	GBL36200	342	375				
 <p><b>top living</b> living worktop</p>								
		<b>P 50,2 sp.1,8 al ml</b> D 50,2 th.1,8 per lm						
		<b>alkorcell L max 270</b> <b>PET L max 240</b>	TLM185A	73	—			
		TLM185P	—	109				
 <p><b>maggiorazione per fianchi di struttura</b> <b>come anta (cadauno)</b> surcharge for carcass sides same finish as door (each)</p>								
		<b>BASI</b> BASE UNITS						
		<b>20,2X48</b>		+30	+42			
		<b>37,5X48</b>		+30	+42			
	<b>51X48</b>		+33	+51				
 <p><b>fianco living</b> lateral finish panel for living base unit</p>								
		<b>P 50,2 sp.1,8 al ml</b> D 50,2 th.1,8 per ml						
		<b>alkorcell</b> <b>PET</b>	TLM185AF	73	—			
		TLM185PF	—	109				









# BASI SOSPENSE LIVING con Attaccaglie e Barre Fissaggio a parete

H 37,5 - 51 P 50,1

HANGING LIVING BASE UNITS with Hangers and Rods for wall mounting







**Le basi non sono comprensive di top - N.B.: cerniere ammortizzate di serie**  
The base units do not include the tops - Note: standard blumotion hinges

		COD.	NECK ALKOR- CELL KS2	NECK PET KS2				
 <p><b>base H 37,5</b> <b>1 anta H 34,2</b> base unit H 37,5 1 door H 34,2</p>	L 45	GBL71451/2	152	168				
	L 60	GBL71601/2	166	184				
 <p><b>base H 37,5</b> <b>2 ante H 34,2</b> base unit H 37,5 2 doors H 34,2</p>	L 90	GBL71900	239	270				
	L 120	GBL72200	274	310				
 <p><b>base H 37,5</b> <b>1 cestone H 34,2</b> base H 37,5 1 deep drawer H 34,2</p>	L 45	GBL75450	206	222				
	L 60	GBL75600	235	253				
	L 90	GBL75900	267	290				
	L 120	GBL76200	317	344				
 <p><b>base H 51</b> <b>1 anta H 47,7</b> base unit H 51 1 door H 47,7</p>	L 45	GBL81451/2	190	209				
	L 60	GBL81601/2	206	228				
 <p><b>base H 51</b> <b>2 ante H 47,7</b> base unit H 51 2 doors H 47,7</p>	L 90	GBL81900	291	328				
	L 120	GBL82200	348	391				
 <p><b>base H 51</b> <b>1 cestone H 47,7</b> base unit H 51 1 deep drawer H 47,7</p>	L 45	GBL85450	230	248				
	L 60	GBL85600	260	281				
	L 90	GBL85900	296	323				
	L 120	GBL86200	348	381				

# BASI LIVING CON ZOCCOLO

H 33,2 - 50,5 - 64 P 59,6





LIVING AREA BASE UNITS WITH PLINTH

Le basi non sono comprensive di top - N.B.: cassetti e cestoni ad estrazione totale con blumotion The base units do not include the tops - Note: fully extending drawers and deep drawers with blumotion system		COD.	NECK ALKOR- CELL KS2	NECK PET KS2			
 <p><b>base H 33,2</b> <b>1 cassetto H 16,9</b> base unit H 33,2 1 drawer H 16,9</p>	L 45	G4203450	167	177			
	L 60	G4203600	184	195			
	L 90	G4203900	222	236			
	L 120	G4204200	260	276			
 <p><b>base H 50,5</b> <b>1 anta H 34,2</b> base unit H 50,5 1 door H 34,2</p>	L 45	G4026451/2	163	179			
	L 60	G4026601/2	187	205			
 <p><b>base H 50,5</b> <b>2 ante H 34,2</b> base unit H 50,5 2 doors H 34,2</p>	L 90	G4026900	262	293			
	L 120	G4027200	304	340			
 <p><b>base H 50,5</b> <b>1 cestone H 34,2</b> base unit H 50,5 1 deep drawer H 34,2</p>	L 45	G4204450	204	219			
	L 60	G4204600	223	241			
	L 90	G4204900	279	302			
	L 120	G4205200	297	324			
 <p><b>base H 50,5</b> <b>2 cassetti H 16,9</b> base unit H 50,5 2 drawers H 16,9</p>	L 45	G4204460	258	278			
	L 60	G4204610	282	304			
	L 90	G4204910	335	362			
	L 120	G4205210	388	419			
 <p><b>base H 64</b> <b>1 anta H 47,7</b> base unit H 64 1 door H 47,7</p>	L 45	G4028451/2	170	188			
	L 60	G4028601/2	195	216			

# BASI LIVING CON ZOCCOLO

LIVING AREA BASE UNITS WITH PLINTH







H 64 P 59,6

Le basi non sono comprensive di top - N.B.: cassetti e cestoni ad estrazione totale con blumotion The base units do not include the tops - Note: fully extending drawers and deep drawers with blumotion system		COD.	NECK ALKOR- CELL KS2	NECK PET KS2				
 <p><b>base H 64</b> <b>2 ante H 47,7</b> base unit H 64 2 doors H 47,7</p>	L 90	G4028900	276	312				
	L 120	G4029200	333	376				
 <p><b>base H 64</b> <b>1 cestone H 47,7</b> base unit H 64 1 deep drawer H 47,7</p>	L 45	G4205450	210	228				
	L 60	G4205600	231	252				
	L 90	G4205900	290	317				
	L 120	G4206200	311	344				
 <p><b>top living</b> living worktop</p>	<b>P 59,7 sp.1,8 al ml</b> D 59,7 th.1,8 per lm <b>alkorcell L max 270</b> <b>PET L max 240</b>							
		TLM186A	83	—				
		TLM186P	—	127				
 <p><b>maggiorazione per fianchi di struttura</b> <b>come anta (cadauno)</b> surcharge for carcass sides same finish as door (each)</p>	<b>BASI</b> BASE UNITS <b>20,2X57,5</b> <b>37,5X57,5</b> <b>51X57,5</b>							
			+30	+42				
			+30	+42				
			+33	+51				
 <p><b>fianco living</b> lateral finish panel for living base unit</p>	<b>P 59,7 sp.1,8 al ml</b> D 59,7 th.1,8 per ml <b>alkorcell</b> <b>PET</b>							
		TLM186AF	83	—				
		TLM186PF	—	127				

# BASI LIVING con piedi H 2,5

LIVING AREA BASE UNITS with feet H 2,5

H 20,5 - 26,5 - 38,5 P 50,1







Le basi non sono comprensive di top - N.B.: cerniere ammortizzate di serie The base units do not include the tops - Note: standard blumotion hinges		COD.	BRIDGE ALKOR- CELL KS1	BRIDGE PET KS1				
 <p><b>base H 20,5</b> <b>1 cassetto H 18</b> base unit H 20,5 1 drawer H 18</p>	L 45	EBL03450	164	174				
	L 60	EBL03600	184	187				
	L 90	EBL03900	219	232				
	L 120	EBL04200	265	280				
 <p><b>base H 26,5</b> <b>1 cassetto H 24</b> base unit H 26,5 1 drawer H 24</p>	L 45	EBL13450	175	191				
	L 60	EBL13600	185	200				
	L 90	EBL13900	232	251				
	L 120	EBL14200	274	297				
 <p><b>base H 38,5</b> <b>1 anta H 36</b> base unit H 38,5 1 door H 36</p>	L 45	EBL21451/2	135	151				
	L 60	EBL21601/2	148	160				
 <p><b>base H 38,5</b> <b>2 ante H 36</b> base unit H 38,5 2 doors H 36</p>	L 90	EBL21900	228	260				
	L 120	EBL22200	262	299				
 <p><b>base H 38,5</b> <b>1 cestone H 36</b> base unit H 38,5 1 deep drawer H 36</p>	L 45	EBL25450	190	206				
	L 60	EBL25600	208	234				
	L 90	EBL25900	246	269				
	L 120	EBL26200	292	320				
 <p><b>base H 38,5</b> <b>2 cassetti H 18</b> base unit H 38,5 2 drawers H 18</p>	L 45	EBL23450	246	266				
	L 60	EBL23600	273	285				
	L 90	EBL23900	324	351				
	L 120	EBL24200	374	406				



# BASI SOSPENSE LIVING con Attaccaglie

HANGING LIVING BASE UNITS with Hangers







H 36 - 48 P 50,1

Le basi non sono comprensive di top - N.B.: cerniere ammortizzate di serie The base units do not include the tops - Note: standard blumotion hinges		COD.	BRIDGE ALKOR- CELL KS1	BRIDGE PET KS1				
 <p><b>base H 36 1 anta</b> base unit H 36 1 door</p>	L 45	EBL71451/2	138	154				
	L 60	EBL71601/2	154	166				
 <p><b>base H 36 2 ante</b> base unit H 36 2 doors</p>	L 90	EBL71900	219	251				
	L 120	EBL72200	247	284				
 <p><b>base H 36 1 cestone</b> base H 36 1 deep drawer</p>	L 45	EBL75450	193	209				
	L 60	EBL75600	211	236				
	L 90	EBL75900	248	271				
	L 120	EBL76200	291	319				
 <p><b>base H 48 1 anta</b> base unit H 48 1 door</p>	L 45	EBL81451/2	164	183				
	L 60	EBL81601/2	184	199				
 <p><b>base H 48 2 ante</b> base unit H 48 2 doors</p>	L 90	EBL81900	260	296				
	L 120	EBL82200	309	351				
 <p><b>base H 48 1 cestone</b> base unit H 48 1 deep drawer</p>	L 45	EBL85450	214	232				
	L 60	EBL85600	233	262				
	L 90	EBL85900	275	302				
	L 120	EBL86200	319	352				

# BASI LIVING CON ZOCCOLO

LIVING AREA BASE UNITS WITH PLINTH







H 31 - 37 - 49 P 59,6

Le basi non sono comprensive di top - N.B.: cassetti e cestoni ad estrazione totale con blumotion The base units do not include the tops - Note: fully extending drawers and deep drawers with blumotion system		COD.	BRIDGE ALKOR- CELL KS1	BRIDGE PET KS1				
 <p><b>base H 31</b> <b>1 cassetto H 18</b> base unit H 31 1 drawer H 18</p>	L 45	E4023450	151	161				
	L 60	E4023600	168	177				
	L 90	E4023900	213	227				
	L 120	E4024200	251	266				
 <p><b>base H 37</b> <b>1 cassetto H 24</b> base unit H 37 1 drawer H 24</p>	L 45	E4025450	166	183				
	L 60	E4025600	181	197				
	L 90	E4025900	238	258				
	L 120	E4026200	262	286				
 <p><b>base H 49</b> <b>1 anta H 36</b> base unit H 49 1 door H 36</p>	L 45	E4026451/2	133	149				
	L 60	E4026601/2	144	163				
 <p><b>base H 49</b> <b>2 ante H 36</b> base unit H 49 2 doors H 36</p>	L 90	E4026900	231	263				
	L 120	E4027200	264	301				
 <p><b>base H 49</b> <b>1 cestone H 36</b> base unit H 49 1 deep drawer H 36</p>	L 45	E4204450	175	191				
	L 60	E4204600	190	209				
	L 90	E4204900	254	278				
	L 120	E4205200	269	297				
 <p><b>base H 49</b> <b>2 cassetti H 18</b> base unit H 49 2 drawers H 18</p>	L 45	E4204460	225	245				
	L 60	E4204610	247	266				
	L 90	E4204910	308	334				
	L 120	E4205210	357	388				

# BASI LIVING CON ZOCCOLO

H 61 P 59,6

LIVING AREA BASE UNITS WITH PLINTH

Le basi non sono comprensive di top - N.B.: cassetti e cestoni ad estrazione totale con blumotion The base units do not include the tops - Note: fully extending drawers and deep drawers with blumotion system		COD.	BRIDGE ALKOR- CELL KS1	BRIDGE PET KS1				
 <p><b>base H 61</b> <b>1 anta H 48</b> base unit H 61 1 door H 48</p>	L 45	E4028451/2	143	162				
	L 60	E4028601/2	155	176				
 <p><b>base H 61</b> <b>2 ante H 48</b> base unit H 61 2 doors H 48</p>	L 90	E4028900	246	282				
	L 120	E4029200	297	339				
 <p><b>base H 61</b> <b>1 cestone H 48</b> base unit H 61 1 deep drawer H 48</p>	L 45	E4205450	185	203				
	L 60	E4205600	202	223				
	L 90	E4205900	268	296				
	L 120	E4206200	286	319				
 <p><b>top living</b> living worktop</p>								
		<b>P 59,7 sp.1,8 al ml</b> D 59,7 th.1,8 per lm						
		<b>alkorcell L max 270</b> <b>PET L max 240</b>	TLM186A	83	—			
		TLM186P	—	127				
 <p><b>maggiorazione per fianchi di struttura</b> <b>come anta (cadauno)</b> surcharge for carcass sides same finish as door (each)</p>								
		<b>BASI</b> BASE UNITS						
		<b>18X57,5</b>		+30	+42			
		<b>24X57,5</b>		+30	+42			
		<b>36X57,5</b> <b>48X57,5</b>		+30 +33	+42 +51			
 <p><b>fianco living</b> lateral finish panel for living base unit</p>								
		<b>P 59,7 sp.1,8 al ml</b> D 59,7 th.1,8 per ml						
		<b>alkorcell</b> <b>PET</b>	TLM186AF	83	—			
		TLM186PF	—	127				



# LIVING KSM1



ANTE  
doors

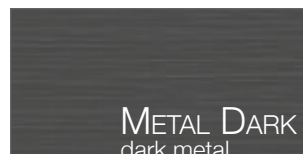
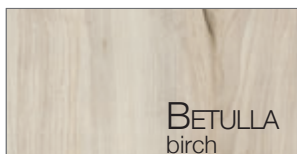

ELEMENTI A GIORNO  
open units



STRUTTURE  
carcasses

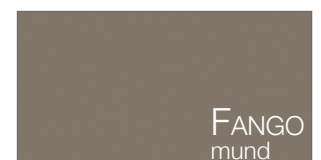

# LIVING KSM1

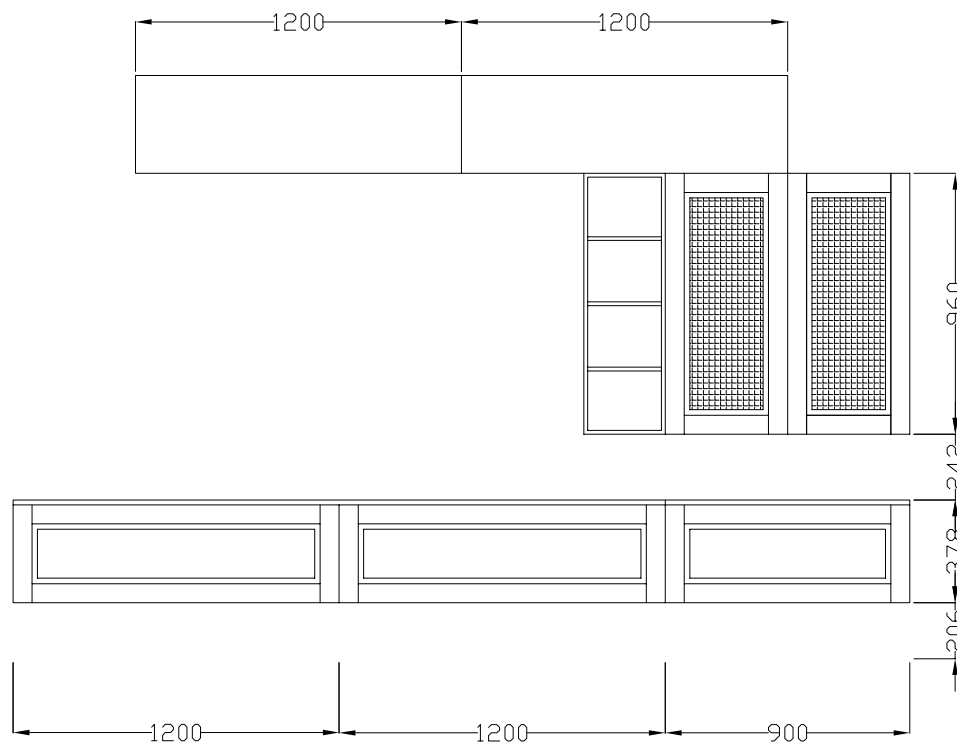

NR. ELEMENTI	DESCRIZIONE	CODICE	€ cad.
2	Pensile L 120 H 36 P 33,1 ribalta tip-on, 1 fianco come anta	E210121T	237
1	Elemento a giorno L 30 H 96 P 31 laccato 4 vani	E7701735	317
2	Pensile vetro L 45 H 96 P 33,1 apertura push-pull, ripiani vetro con luce	E1020450	205
4	Profilo led GLASS_8 Ital Pek per ripiano vetro L 45	08616263	56
1	Trasformatore per luce GLASS_8 Ital Pek 50W	08616192A	52
1	Base living sospesa L 120 H 36 P 50,1 cestone apertura tip-on, 1 fianco come anta	EBL76200	366
1	Base living sospesa L 120 H 36 P 50,1 cestone apertura tip-on	EBL76200	336
1	Base living sospesa L 90 H 36 P 50,1 cestone apertura tip-on	EBL75900	293
1	Top L 240+90 H 1,8 P 50,2 in alkorcell come anta	al ml TLM185A	73
3	Asta appendipensili ml 2	al ml 08610501	9
<b>TOTALE</b>			<b>2.740</b>

No. of ELEMENTS	DESCRIPTION	CODE	€ each
2	Wall unit W 120 H 36 D 33,1 flap door tip-on opening, 1 side same as door	E210121T	237
1	Lacquered open unit W 30 H 96 D 31 4 compartments	E7701735	317
2	Glass wall unit W 45 H 96 D 33,1 push-pull opening, glass shelves with light	E1020450	205
4	Led profile GLASS_8 Ital Pek for glass shelf W 45	08616263	56
1	Power supply for light GLASS_8 Ital Pek 50W	08616192A	52
1	Hanging living base unit W 120 H 36 D 50,1 deep drawer tip-on opening, 1 side same as door	EBL76200	366
1	Hanging living base unit W 120 H 36 D 50,1 deep drawer tip-on opening	EBL76200	336
1	Hanging living base unit W 90 H 36 D 50,1 deep drawer tip-on opening	EBL75900	293
1	Alkorcell worktop W 240+90 H 1,8 D 50,2 same as door	per lm TLM185A	73
3	Wall unit fixing strip lm 2	per lm 08610501	9
<b>TOTAL</b>			<b>2.740</b>

# LIVING KSM2



ANTE  
doors

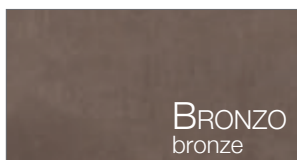

ELEMENTI A GIORNO  
open units

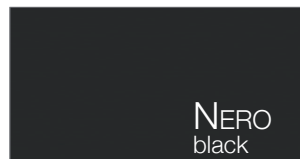

STRUTTURE  
carcasses



# LIVING KSM2

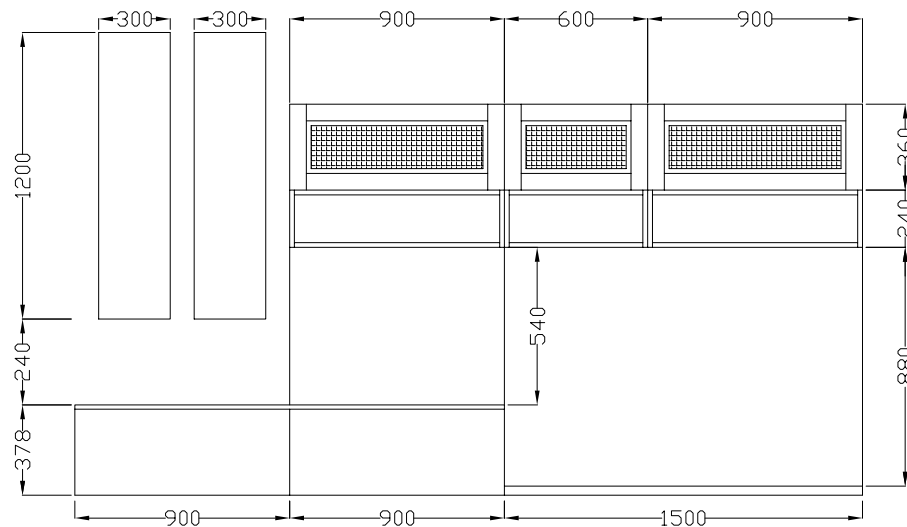

NR. ELEMENTI	DESCRIZIONE	CODICE	€ cad.
2	Pensile L 30 H 120 P 33,1 apertura push-pull, fianchi come anta	E2145301/2	262
2	Pensile vetro L 90 H 36 P 33,1 ribalta, 1 fianco come anta	E1100900	259
1	Pensile vetro L 60 H 36 P 33,1 ribalta	E1100600	196
5	Faretto Sunrise 58 L&S	08618082	24
1	Trasformatore Mec Drive 100-240V 36W L&S	08618001	43
1	Cavo di alimentazione Mec Drive L&S	08618020	6
1	Modulo Distributor 8 ways	08618025	8
2	Pensile a giorno alluminio AIR HI-LINE L 90 H 24 P 31 ripiano vetro	E7800090	326
1	Pensile a giorno alluminio AIR HI-LINE L 60 H 24 P 31 ripiano vetro	E7800060	278
1	Base living sospesa L 90 H 36 P 50 cestone apertura tip-on	EBL75900	261
1	Base living sospesa L 90 H 36 P 50 cestone apertura tip-on, 1 fianco come anta	EBL75900	291
1	Mensola L 150 H 3,8 P 31 colore come anta	al ml 091523	116
1	Top L 180 H 1,8 P 50,1 colore come anta	al ml TLE185	68
1	Schienale L 150 H 88 sp.1,8 colore come anta	al mq 0943639	202
1	Schienale L 90 H 54 sp.1,8 colore come anta	al mq 0943639	202
2	Asta appendipensili ml 2	al ml 08610501	9
<b>TOTALE</b>			<b>3.576</b>
No. of ELEMENTS	DESCRIPTION	CODE	€ each
2	Wall unit W 30 H 120 D 33, 1 push-pull opening, sides same as door	E2145301/2	262
2	Glass wall unit W 90 H 36 D 33,1 flap door, 1 side same as door	E1100900	259
1	Glass wall unit W 60 H 36 D 33,1 flap door	E1100600	196
5	Sunrise 58 spotlight L&S	08618082	24
1	Mec Drive power supply 100-240V 36W L&S	08618001	43
1	Mec Drive power cable L&S	08618020	6
1	Distributor module 8 ways	08618025	8
2	Aluminium open wall unit AIR HI-LINE W 90 H 24 D 31 glass shelf	E7800090	326
1	Aluminium open wall unit AIR HI-LINE W 60 H 24 D 31 glass shelf	E7800060	278
1	Hanging living base unit W 90 H 36 D 50 deep drawer tip-on	EBL75900	261
1	Hanging living base unit W 90 H 36 D 50 deep drawer tip-on 1 side same as door	EBL75900	291
1	Shelf W 150 H 3,8 D 31 same colour as door	per lm 091523	116
1	Worktop W 180 H 1,8 D 50,1 same colour as door	per lm TLE185	68
1	Back panel W 150 H 88 th.1,8 same colour as door	per mq 0945639	202
1	Back panel W 90 H 54 th.1,8 same colour as door	per mq 0945639	202
2	Wall unit fixing strip lm 2	per lm 08610501	9
<b>TOTAL</b>			<b>3.576</b>

# LIVING KSM3



ANTA  
door



ELEMENTI A GIORNO  
open units

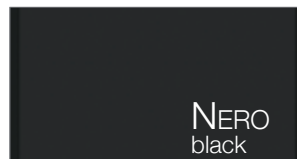

STRUTTURA  
carcass

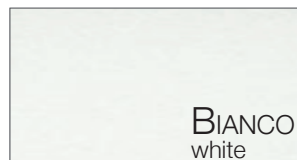

# LIVING KSM3

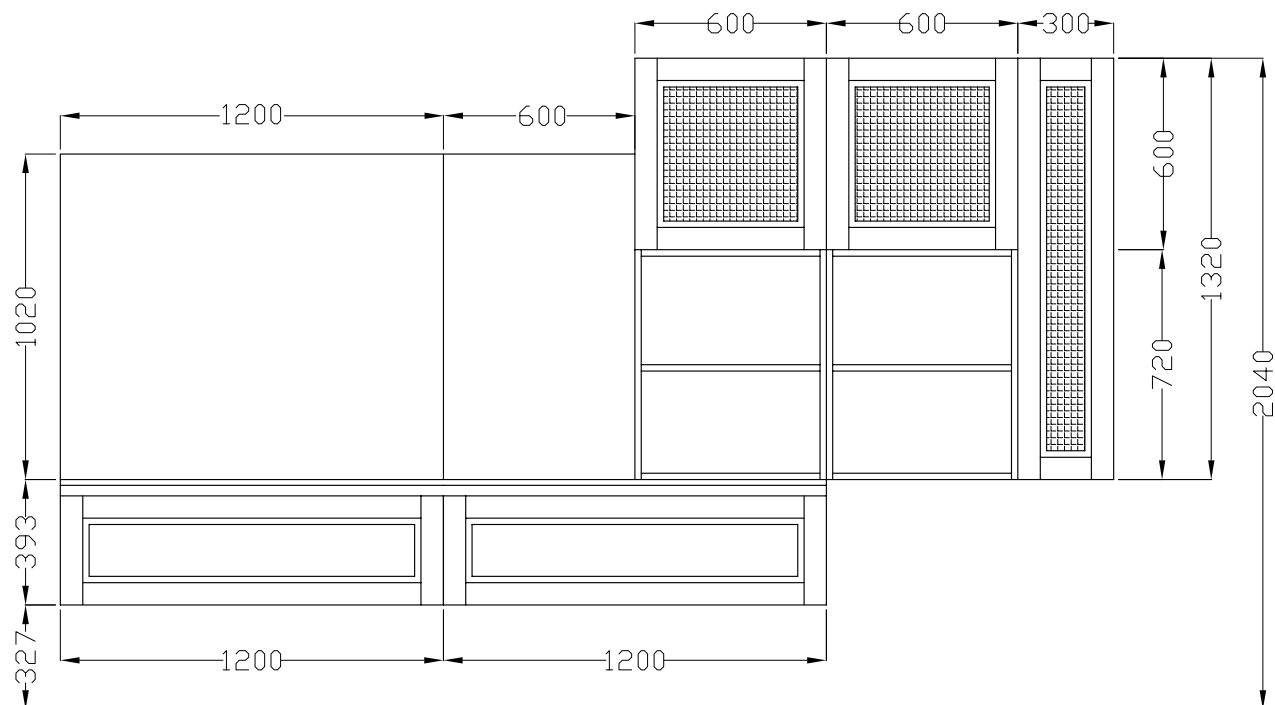

NR. ELEMENTI	DESCRIZIONE	CODICE	€ cad.
1	Pensile vetro L 30 H 132 P 33,1 apertura push-pull, ripiani vetro	E1025301/2	260
2	Pensile vetro L 60 H 60 P 33,1 apertura push-pull, ripiano vetro	E1060601/2	177
3	Faretto Spot_3328 Ital Pek	08616175	44
1	Alimentatore 50W per faretto Spot_3328 Ital Pek	08616192A	52
2	Pensile a giorno alluminio AIR HI-LINE L 60 H 72 P 31 ripiano vetro	E7804060	491
1	Schienale L 120 H 102 sp.1,8 colore come anta	al mq 094571V	184
1	Schienale L 60 H 102 sp.1,8 colore come anta	al mq 094571V	184
2	Base living sospesa L 120 H 37,5 P 50,1, 1 fianco come anta	GBL76200	347
1	Top L 240 H 1,8 P 50,2 colore come anta	al ml TLM185A	73
1	Asta appendipensili ml 2	al ml 08610501	9
<b>TOTALE</b>			<b>2.996</b>
No. of ELEMENTS	DESCRIPTION	CODE	€ each
1	Glass wall unit W 30 H 132 D 33,1 push-pull opening, glass shelves	E1025301/2	260
2	Glass wall unit W 60 H 60 D 33,1 push-pull opening, glass shelf	E1060601/2	177
3	Spot_3328 spotlight Ital Pek	08616175	44
1	Power supply 50W for Spot_3328 spotlight Ital Pek	08616192A	52
2	Aluminium open wall unit AIR HI-LINE W 60 H 72 D 31 glass shelf	E7804060	491
1	Back panel W 120 H 102 th.1,8 same colour as door	per mq 094571V	184
1	Back panel W 60 H 102 th.1,8 same colour as door	per mq 094571V	184
2	Hanging living base unit W 120 H 37,5 D 50,1, 1 side same as door	GBL76200	347
1	Worktop W 240 H 1,8 D 50,2 same colour as door	per lm TLM185A	73
1	Wall unit fixing strip lm 2	per lm 08610501	9
<b>TOTAL</b>			<b>2.996</b>

# LIVING KSM4



ANTE  
doors



ELEMENTI A GIORNO  
open units



STRUTTURE  
carcasses

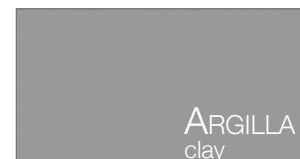

# LIVING KSM4

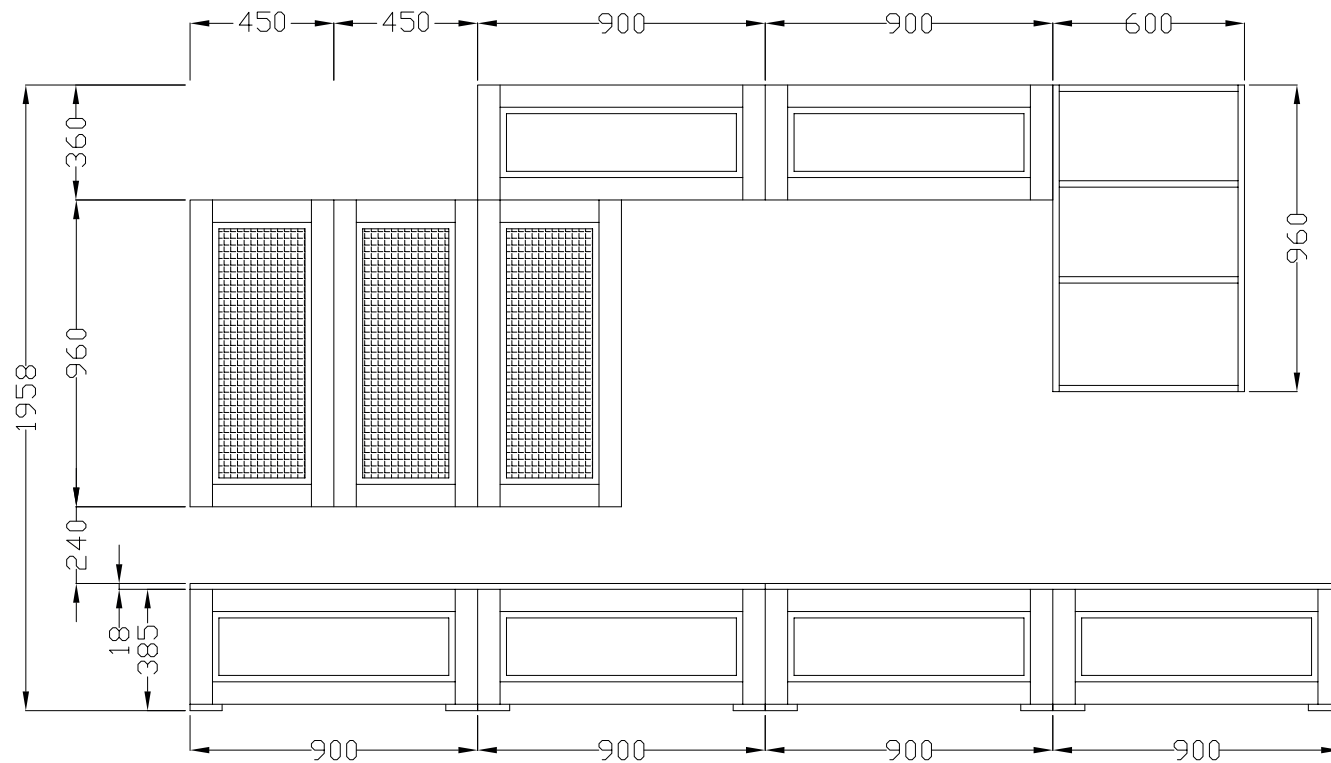

NR. ELEMENTI	DESCRIZIONE	CODICE	€ cad.
2	Pensile L 90 H 36 P 33,1 anta ribalta tip-on, 1 fianco come anta	E210091T	254
2	Pensile vetro L 45 H 96 P 33,1 apertura push-pull, ripiani vetro con luce, 1 fianco come anta	E1020451/2	293
1	Pensile vetro L 45 H 96 P 33,1 apertura push-pull, ripiani vetro con luce	E1020451/2	242
1	Pensile a giorno alluminio AIR HI-LINE L 60 H 96 P 31 ripiani vetro	E7805060	684
2	Base living L 90 H 36 P 50,1 cestone, 1 fianco come anta	EBL25900	276
2	Base living L 90 H 36 P 50,1 cestone	EBL25900	246
1	Top L 180+180 H 1,8 P 50,2 colore come anta	al ml TLM185A	73
6	Profilo led GLASS_8 Ital Pek per ripiano vetro L 45	08616263	56
1	Trasformatore per luce GLASS_8 Ital Pek 50W	08616192A	52
2	Asta appendipensili ml 2	al ml 08610501	9
<b>TOTALE</b>			<b>3.733</b>

No. of ELEMENTS	DESCRIPTION	CODE	€ each
2	Wall unit W 90 H 36 D 33,1 flap door tip-on, 1 side same as door	E210091T	254
2	Glass wall unit W 45 H 96 D 33,1 push-pull opening, glass shelves with light, 1 side same as door	E1020451/2	293
1	Glass wall unit W 45 H 96 D 33,1 push-pull opening, glass shelves with light	E1020451/2	242
1	Aluminium open wall unit AIR HI-LINE W 60 H 96 D 31 glass shelves	E7805060	684
2	Living base unit W 90 H 36 D 50,1 deep drawer, side same as door	EBL25900	276
2	Living base unit W 90 H 36 D 50,1 deep drawer	EBL25900	246
1	Worktop W 180+180 H 1,8 D 50,2 same colour as door	per lm TLM185A	73
6	Led profile GLASS_8 Ital Pek for glass shelf W 45	08616263	56
1	Power supply for light GLASS_8 Ital Pek 50W	08616192A	52
2	Wall unit fixing strip lm 2	per lm 08610501	9
<b>TOTAL</b>			<b>3.733</b>



## COMPOSIZIONE BASSA L 255 (con gola L 260)

LOW COMPOSITION W 255 (with finger rail W 260)



## COMPOSIZIONE BASSA L 300 (con gola L 305)

LOW COMPOSITION W 300 (with finger rail W 305)



**COMPOSIZIONE BASSA L 255 (con gola L 260)**

LOW COMPOSITION W 255 (with finger rail W 260)

(IVA e contributo RAEE esclusi)

(VAT and WEEE fee excluded)

COMPONENTI COMPONENTS	VERSIONI VERSIONS
<p><b>Colonna 60 frigo-freezer 230 classe A+</b> 60 cm column fridge-freezer 230 class "A+"</p> <p><b>Base 45 2 cassetti e cestone</b> 45 cm base unit with 2 drawers and deep drawer</p> <p><b>Base 60 forno statico inox con ventilazione tangenziale di raffreddamento</b> stainless steel static oven with orbital cooling ventilation 60 base unit</p> <p><b>Piano cottura 60 4 gas inox con valvola di sicurezza</b> 60 cm stainless steel hob with 4 gas burners with safety valve</p> <p><b>Sottolavello 90</b> 90 cm sink unit</p> <p><b>Lavello ad incasso 86x50 1 vasca inox prelucidato</b> 86x50 cm built-in sink with 1 stainless steel bowl</p> <p><b>Pensile 45 H 72</b> 45 cm wall unit H 72</p> <p><b>Cappa 60 aspirante estraibile H 63 2 motori</b> 60 cm hood slide-out ducting H 63 2 motors</p> <p><b>Scolapiatti 90 H 72</b> 90 cm plate rack H 72</p> <p><b>Top 195 P 61 in laminato H 4</b> 195 cm laminate worktop D 61 H 4</p> <p><b>Asta appendipensili ml 2</b> 2 lm wall unit fixing strip</p> <p style="text-align: center;"><b>(Elettrodomestici Indesit)</b> (Indesit appliances)</p>	<p><b>ALKORCELL</b></p> <p><b>BRIDGE</b> € 3.644</p> <p><b>NECK</b> € 4.059</p> <p><b>PET</b></p> <p><b>BRIDGE</b> € 3.906</p> <p><b>NECK</b> € 4.407</p>

**COMPOSIZIONE BASSA L 300 (con gola L 305)**

LOW COMPOSITION W 300 (with finger rail W 305)

(IVA e contributo RAEE esclusi)

(VAT and WEEE fee excluded)

COMPONENTI COMPONENTS	VERSIONI VERSIONS
<p><b>Colonna 60 frigo-freezer 230 classe A+</b> 60 cm column fridge-freezer 230 class "A+"</p> <p><b>Base 60 2 cassetti e cestone</b> 60 cm base unit with 2 drawers and deep drawer</p> <p><b>Base 60 forno statico inox con ventilazione tangenziale di raffreddamento</b> stainless steel static oven with orbital cooling ventilation 60 base unit</p> <p><b>Piano cottura 60 4 gas inox con valvola di sicurezza</b> 60 cm stainless steel hob with 4 gas burners with safety valve</p> <p><b>Base 60</b> 60 cm base unit</p> <p><b>Sottolavello 60</b> 60 cm sink unit</p> <p><b>Lavello ad incasso 86x50 1 vasca inox prelucidato</b> 86x50 cm built-in sink with 1 stainless steel bowl</p> <p><b>Pensile 60 H 72</b> 60 cm wall unit H 72</p> <p><b>Cappa 60 aspirante estraibile H 63 2 motori</b> 60 cm hood slide-out ducting H 63 2 motors</p> <p><b>Pensile 60 H 72</b> 60 cm wall unit H 72</p> <p><b>Scolapiatti 60 H 72</b> 60 cm plate rack H 72</p> <p><b>Top 240 P 61 in laminato H 4</b> 240 cm laminate worktop D 61 H 4</p> <p><b>Asta appendipensili ml 4</b> 4 lm wall unit fixing strip</p> <p style="text-align: center;"><b>(Elettrodomestici Indesit)</b> (Indesit appliances)</p>	<p><b>ALKORCELL</b></p> <p><b>BRIDGE</b> € 3.893</p> <p><b>NECK</b> € 4.339</p> <p><b>PET</b></p> <p><b>BRIDGE</b> € 4.177</p> <p><b>NECK</b> € 4.712</p>

## COMPOSIZIONE ALTA L 300 (con gola L 305)

HIGH COMPOSITION W 300 (with finger rail W 305)



## COMPOSIZIONE BASSA L 360 (con gola L 365)

LOW COMPOSITION W 360 (with finger rail W 365)



**COMPOSIZIONE ALTA L 300 (con gola L 305)**

HIGH COMPOSITION W 300 (with finger rail W 305)

(IVA e contributo RAEE esclusi)

(VAT and WEEE fee excluded)

COMPONENTI COMPONENTS	VERSIONI VERSIONS
<p><b>Colonna 60 frigo-freezer 230 classe A+</b> 60 cm column fridge-freezer 230 class "A+"</p> <p><b>Base 60 2 cassetti e cestone</b> 60 cm base unit with 2 drawers and deep drawer</p> <p><b>Base 60 forno statico inox con ventilazione tangenziale di raffreddamento</b> stainless steel static oven with orbital cooling ventilation 60 base unit</p> <p><b>Piano cottura 60 4 gas inox con valvola di sicurezza</b> 60 cm stainless steel hob with 4 gas burners with safety valve</p> <p><b>Base 60</b> 60 cm base unit</p> <p><b>Sottolavello 60</b> 60 cm sink unit</p> <p><b>Lavello ad incasso 86x50 1 vasca inox prelucidato</b> 86x50 cm built-in sink with 1 stainless steel bowl</p> <p><b>Pensile 60 H 72</b> 60 cm wall unit H 72</p> <p><b>Cappa 60 aspirante estraibile H 63 2 motori</b> 60 cm hood slide-out ducting H 63 2 motors</p> <p><b>Pensile 60 H 96</b> 60 cm wall unit H 96</p> <p><b>Scolapiatti 60 H 96</b> 60 cm plate rack H 96</p> <p><b>Top 240 P 61 in laminato H 4</b> 240 cm laminate worktop D 61 H 4</p> <p><b>Mensola 120 P 31 sp. 3,8</b> 120 cm shelf D 31 sp. 3,8</p> <p><b>Asta appendipensili ml 4</b> 4 lm wall unit fixing strip</p> <p style="text-align: center;"><b>(Elettrodomestici Indesit)</b> (Indesit appliances)</p>	<p><b>ALKORCELL</b></p> <p><b>BRIDGE</b> € 4.070</p> <p><b>NECK</b> € 4.543</p> <p><b>PET</b></p> <p><b>BRIDGE</b> € 4.372</p> <p><b>NECK</b> € 4.941</p>

**COMPOSIZIONE BASSA L 360 (con gola L 365)**

LOW COMPOSITION W 360 (with finger rail W 365)

(IVA e contributo RAEE esclusi)

(VAT and WEEE fee excluded)

COMPONENTI COMPONENTS	VERSIONI VERSIONS
<p><b>Colonna 60 frigo-freezer 230 classe A+</b> 60 cm column fridge-freezer 230 class "A+"</p> <p><b>Colonna 60 con cestone, forno statico inox con ventilazione tangenziale di raffreddamento</b> 60 column with deep drawer configured for stainless steel static oven with orbital cooling ventilation</p> <p><b>Base 90 2 cassetti + cestone predisposto P.C.</b> 90 cm base unit with 2 drawers + deep drawer configured for hob</p> <p><b>Piano cottura 60 4 gas inox con valvola di sicurezza</b> 60 cm stainless steel hob with 4 gas burners with safety valve</p> <p><b>Base 60</b> 60 cm base unit</p> <p><b>Sottolavello 90</b> 90 cm sink unit</p> <p><b>Lavello ad incasso 86x50 1 vasca inox prelucidato</b> 86x50 cm built-in sink with 1 stainless steel bowl</p> <p><b>Pensile 60 H 72</b> 60 cm wall unit H 72</p> <p><b>Cappa 90 sempione acciaio inox satinato + vetro</b> 90 cm sempione hood brushed stainless steel + glass</p> <p><b>Pensile 60 H 72</b> 60 cm wall unit H 72</p> <p><b>Scolapiatti 90 H 72</b> 90 cm plate rack H 72</p> <p><b>Top 240 P 61 in laminato H 4</b> 240 cm laminate worktop D 61 H 4</p> <p><b>Top 60 P 61 in laminato H 4</b> 60 cm laminate worktop D 61 H 4</p> <p><b>Asta appendipensili ml 4</b> 4 lm wall unit fixing strip</p> <p style="text-align: center;"><b>(Elettrodomestici Indesit)</b> (Indesit appliances)</p>	<p><b>ALKORCELL</b></p> <p><b>BRIDGE</b> € 4.314</p> <p><b>NECK</b> € 4.747</p> <p><b>PET</b></p> <p><b>BRIDGE</b> € 4.626</p> <p><b>NECK</b> € 5.139</p>

