



**MAGGIORAZIONE
SURCHARGE**

+ 8%

**DAL 23 GENNAIO 2023
FROM JANUARY 23, 2023**

REWIND moderno

CONDIZIONI GENERALI DI VENDITA

DECORRENZA

Il presente listino sostituisce ed annulla tutti i precedenti.

Non costituisce offerta e può essere modificato, con comunicazione scritta dell'AZIENDA al Cliente, in qualsiasi momento anche senza preavviso.

Le modificazioni o gli aggiornamenti avranno efficacia rispetto a tutti gli ordinativi pervenuti o trasmessi all'AZIENDA dopo la comunicazione scritta di cui sopra.

PREZZI DI LISTINO E CONDIZIONI DI PAGAMENTO

I prezzi sono quotati al pubblico I.V.A. e contributo RAEE esclusi e si intendono franco fabbrica.

Decorso il termine contrattuale di pagamento l'AZIENDA è autorizzata alla emissione di tratte a saldo di ogni suo avere maggiorate degli interessi, spese e di ogni altro onere accessorio, previa comunicazione al Cliente. In caso di pagamento oltre i termini contrattuali, saranno addebitati gli interessi ai sensi del D.lgs. 231/2002, oltre al recupero di eventuali sconti espressamente concessi in ragione del termine di pagamento.

In caso di mancato pagamento nei tempi contrattuali l'AZIENDA potrà sospendere l'evasione degli ordini in corso previa comunicazione al Cliente.

CONSEGNA

I termini di consegna vengono computati in giorni lavorativi con decorrenza dal perfezionamento del contratto di vendita, che comunque si intende perfezionato entro 8 giorni dall'invio dell'ordine o comunque entro 8 giorni dall'ultimo chiarimento (se richiesto) fornito dal Cliente. I termini di consegna saranno prorogati automaticamente in dipendenza di avvenimenti non imputabili all'AZIENDA o a cause di forza maggiore. Sono sempre ammesse consegne parziali.

PRODOTTO

I dati tecnici relativi ai prodotti illustrati nel presente listino sono puramente indicativi come indicativi. L'AZIENDA si riserva la facoltà di apportare tutte le modifiche tecnico-costruttive migliorative del prodotto, senza obbligo di preavviso. La merce potrà tuttavia presentare caratteristiche parzialmente difformi da quelle indicate nel listino e nel catalogo, e comunque non risultare del tutto identica ai campioni che eventualmente fossero stati visionati in occasione della effettuazione dell'ordine, dovendosi riconoscere margini di tolleranza per quanto concerne i colori e le tonalità. La conformità al campione non deve intendersi in senso tassativo. Ciò vale anche per gli elettrodomestici o altri accessori impiegati a corredo delle cucine; questi potranno risultare esteticamente leggermente difformi in base alle marche utilizzate diverse da quelle da catalogo, salvo la sostanziale conformità delle caratteristiche e delle funzioni. Il Cliente potrà richiedere elementi specifici indicandone la marca sempre nell'ambito del ventaglio di offerte dell'AZIENDA non assume alcuna responsabilità circa la tenuta dei supporti che dipendesse da insufficienza della parete a cui venissero applicati gli stessi poiché la verifica dell'idoneità della parete dovrà essere effettuata dal cliente.

CONSISTENZA FINITURE

Le finiture potrebbero subire nel tempo modificazioni di colore dovute all'esposizione alla luce, al calore, ai vapori e all'invecchiamento. È, pertanto, naturale che in caso di successivi completamenti, si potranno avere delle differenze di tonalità che comunque dovrebbero tendere ad attenuarsi nel tempo. Per i piani in marmo e granito, considerando che il taglio proviene da BLOCCHI NATURALI, non possiamo garantire l'uniformità del colore e della grana. Questi fattori non potranno costituire motivo di contestazione o di resa del prodotto.

TRASPORTO

La merce non viaggia mai con mezzi dell'AZIENDA e, di conseguenza, nel momento in cui questa viene affidata al vettore, a prescindere da chi lo abbia incaricato, o caricata nel mezzo del cliente tutti i rischi passano al cliente stesso. Il Cliente, anche tramite suoi incaricati, ha l'obbligo di controllare l'integrità della merce all'arrivo ed, eventualmente, fare le dovute contestazioni scritte al Vettore. Qualora il danno rende inutilizzabile la merce è opportuno non ritirarla dandone conto nel Documento di Trasporto, diversamente con l'apposizione della firma da parte del Cliente, senza alcuna contestazione e/o rilievo si attesta la perfetta integrità e conformità della merce.

INSTALLAZIONE E IMPIEGO

L'AZIENDA declina ogni responsabilità per l'errata o impropria installazione del prodotto fornito (mobili, piani di lavoro, elettrodomestici, impianti elettrici o idraulici ecc.) siano essi di sua fabbricazione o di terzi, sempre che non provveda essa stessa alle predette operazioni. L'acquirente non potrà in nessun caso richiedere il risarcimento dei danni eventualmente causati in occasione dell'installazione. L'AZIENDA si ritiene esonerata da qualsiasi responsabilità circa il funzionamento degli elettrodomestici e degli accessori fabbricati da terzi costruttori, per i quali venga fornito dal predetto fabbricante lo specifico libretto di uso e manutenzione; nel libretto si troverà indicato l'eventuale Ufficio Reclami o i Centri di Assistenza del terzo fabbricante. Per l'impropria e/o inadeguata manutenzione, nonché per l'improprio e/o inadeguato utilizzo dei prodotti venduti, l'AZIENDA rinvia ogni e qualsiasi responsabilità e/o onere al Cliente o all'Utilizzatore.

RECLAMI ED AZIONI

I vizi e i difetti devono essere denunciati all'AZIENDA nei termini di legge. Anche nel caso di contestazione i pagamenti non potranno essere sospesi.

La merce rimarrà di proprietà dell'AZIENDA sino al pagamento totale da parte del committente.

GARANZIA

La garanzia sui prodotti venduti opererà per il tempo che, di volta in volta, le leggi vigenti nel Paese del Cliente stabiliranno come minimo a favore dell'acquirente.

RESTITUZIONE DI MERCE

La restituzione delle merci vendute si accetta solo se espressamente autorizzata dalla LUBE INDUSTRIES s.r.l.. Verranno concordate modalità di reintegro e di accredito, solo qualora la restituzione sia dovuta a fatti imputabili alla LUBE INDUSTRIES s.r.l.. La merce restituita dovrà essere consegnata in perfette condizioni e adeguatamente imballata. La merce da sostituire dovrà essere restituita senza ritardo dal commerciante alla fabbricante. Nel caso in cui detta merce sia restituita tra i quattro e gli otto mesi dalla sostituzione la fabbricante accrediterà al commerciante il settanta per cento del valore della merce sostituita; qualora la restituzione avvenga tra gli otto ed i dodici mesi dalla sostituzione sarà accreditato al commerciante il cinquanta per cento del valore della merce sostituita; qualora la restituzione non sia compiuta nei dodici mesi vi sarà accreditato il venticinque per cento del valore della merce sostituita.

SPESE

Per i pagamenti a mezzo tratte o ricevute bancarie verranno addebitati tutti gli oneri accessori alla riscossione.

CONTROVERSIE

Per ogni controversia il Foro competente sarà esclusivamente quello di Macerata.

EFFICACIA

Il Cliente, con il solo fatto di conferire l'ordinativo, si dichiara edotto ed accetta tutte le condizioni di vendita che precedono, salvo espresso patto contrario.

MARCHIO

Il marchio  è un marchio commerciale registrato, la proprietà dei diritti di utilizzazione economica appartengono esclusivamente a l'AZIENDA o a terzi, pertanto è espressamente vietato l'utilizzo senza il preventivo consenso scritto del proprietario. L'utilizzo del marchio da parte dei clienti ai fini pubblicitari dovrà comunque essere preventivamente autorizzato dall'AZIENDA previa presa visione del materiale prima della pubblicazione. In ogni caso il logo non potrà subire alcuna modifica od alterazione nelle forme e nei colori ne potrà essere associato a prezzi o sconti promozionali.

GENERAL SALES CONDITIONS

VALIDITY

This price list replaces and annuls all previous versions.

It does not constitute an offer and may be subject to change following a written notification by COMPANY to the Customer, at any time and without prior notice.

Any modifications or updates shall apply to all orders received by or transmitted to COMPANY following the above-mentioned written notification.

RETAIL PRICES AND PAYMENT TERMS

The retail prices quoted are exclusive of VAT and the WEEE fee and are ex works.

Upon expiry of the agreed payment term, COMPANY shall be authorised to issue bills of exchange for any outstanding amounts on every item, plus interest, expenses and any other additional liability, prior notification to the Customer. In the event of payment after the agreed term, accrued interest shall be charged in compliance with Italian Legislative Decree no. 231/2002, while any discounts expressly granted in relation to the payment terms shall be recovered.

If payment is not received within the agreed terms, COMPANY shall be entitled to suspend fulfilment of current orders, prior notification to the Customer.

DELIVERY

The delivery term is calculated in working days and takes effect from the date on which the sales contract is stipulated. In any case, the contract is considered effective within 8 days from order transmission or, at all events, within 8 days from the most recent clarification (if requested) provided by the Customer. The delivery term shall be automatically extended should any events occur that are not imputable to COMPANY or that are due to force majeure. Partial deliveries can always be effected.

THE PRODUCT

Any technical data relating to the products illustrated in this price list is purely indicative. The COMPANY reserves the right to effect any technical or structural modifications to improve the product, without prior notice. The goods may differ to some extent from the specifications given in the price list and the catalogue, or not be identical in all aspects to the samples viewed at the time of the order, since tolerances in relation to colours and tonalities are inevitable. Conformity with the samples is not obligatory. This right extends to household appliances or other kitchen furniture accessories; the appearance of the latter may differ slightly depending on the brand in question (which may differ from that shown in the catalogue), without prejudice to the basic conformity of features and functions. The Client may request specific components of a given brand from the range of products offered by the COMPANY, which is not liable in any way for the load bearing capacity of supports depending on the characteristics of the walls to which they are mounted; the Client alone is responsible for ensuring that the walls are able to support the load.

CONSISTENCY OF THE FINISHES

The finishes may be subject to slight changes in colour over time as a result of exposure to light, heat, vapours and ageing. Therefore, in the event of completion orders, there may be shade differences that will tend to diminish over time. Regarding marble and granite worktops, we cannot guarantee uniformity of colour and vein pattern as the worktops are cut from NATURAL BLOCKS. These factors may not provide grounds for claims or return of products.

TRANSPORT

The goods never travel on vehicles owned by COMPANY; therefore, from the moment the goods are handed over to the forwarder and regardless of who entrusted the latter with the transport or loaded the goods into the customer's vehicle, all risks are transferred to the customer. The Customer - also through persons delegated by the latter - is obliged to check the integrity of the goods upon their arrival, and to notify written claims to the Forwarder. The Customer should not accept any damaged goods that are unsuitable for their intended use, and should notify the relevant claim on the transport document; otherwise, by signing the transport document without adding any claims and/or observations, the Customer certifies the integrity and conformity of the goods.

INSTALLATION AND USE

The COMPANY is not liable for incorrect or improper installation of the supplied product (units, tops, household appliances, electrical and plumbing systems, etc.), whether manufactured by the company or by third parties, unless the COMPANY itself does the installation. The purchaser may not claim for any damages caused during installation. Moreover, the COMPANY is not liable for the operation of household appliances and accessories manufactured by third parties, for which user and maintenance manuals are provided by the manufacturer in question; the manuals include information regarding the Claims Office or Technical Assistance Centres of the third party manufacturer. As regards improper and/or inadequate maintenance, or any improper and/or inadequate use of the products sold, the COMPANY transfers all liability and/or resulting costs to the Client or User.

CLAIMS

Any faults or defects must be reported to COMPANY within the terms specified by the law. Payment may not be suspended, even in the event of notification of claims.

The goods shall remain the property of COMPANY unless fully paid by customer.

WARRANTY

Warranty on sold products in favour of the purchaser shall apply for the minimum duration specified case-by-case by the laws in force in the Customer's country.

RETURN OF GOODS

Return of sold goods is only accepted if expressly authorised by LUBE INDUSTRIES s.r.l.. Replacement or reimbursement of said goods shall be mutually defined only if the goods return is due to events imputable to LUBE INDUSTRIES s.r.l.. The returned goods must be delivered in perfect conditions and suitably packaged.

The goods to be replaced must be returned from the retailer to the producer without delay. In the case that the goods are returned between four and eight months after replacing, the producer will credit the retailer 70% of the replaced goods value; if the return is between eight and twelve months after the replacement, will be credited to the retailer 70% of the replaced goods value; if the refund is not made within twelve months will be credited 25% of the replaced goods value.

EXPENSES

For payments effected through bill of exchange or cash order, all additional collection expenses shall be charged.

DISPUTES

The Court of Macerata shall have sole jurisdiction for any disputes that may arise.

EFFECTIVENESS

For the sole fact of conferring the order, the Customer declares to be informed and accepts all the aforementioned sale conditions, unless otherwise expressly agreed on.

BRAND

The trademark  is registered; the right of the commercial exploitation belongs only to the COMPANY or a third party, and the trademark may not be used without the owner's written consent. The client may only use the trademark for reasons of publicity if authorised in advance by COMPANY, following review of the material before publication.

In any case, the logo may not be modified or altered in form or colour, nor may it be associated with promotional prices or discounts.

INFORMAZIONI TECNICHE

TECHNICAL INFORMATION

Le misure indicate nel presente listino sono espresse in cm.

Le profondità delle basi si intendono comprensive di top.

Le profondità dei pensili e delle colonne si intendono comprensive di ante.

Le altezze delle basi e delle colonne si intendono comprensive di zoccolo

Il verso degli elementi è individuato dalla posizione delle cerniere. Fanno eccezione solo l'angolo base e la colonna ad angolo dove il verso viene individuato dalla posizione dell'anta rispetto al mobile.

Per gli elementi con il verso, è stato inserito il codice con entrambi i versi (ad esempio una base da cm 45 cod. E4010451/2).

Sarà quindi necessario specificare se l'ultima cifra dovrà essere "1" per il verso destro cioè E4010451 oppure "2" per il verso sinistro cioè E4010452.

Per i lavelli il verso dx o sx è individuato dalla posizione delle vasche.

I prezzi indicati sono espressi all'unità di euro e sono IVA e contributo RAEE esclusi

I prezzi delle basi e delle colonne sono comprensivi dello zoccolo standard.

Per tutti i mobili fuori misura ha valore il listino riportato nella pagina maggiorazioni fuori misura.

Nel caso vengano richieste maniglie con passo diverso da quello previsto dal modello, le ante verranno fornite senza fori maniglia.

I colori delle immagini riportate nel presente listino sono solamente indicativi e non possono essere utilizzati come riferimento.

The measurements appearing in this price list are expressed in cm.

The depths of base units are inclusive of the worktop.

The depths of the wall units and columns are inclusive of the doors.

The heights of the base units and columns are inclusive of the plinth.

The direction of the elements is determined by the position of the hinges. The only exceptions are the corner base unit and corner column, where the direction is determined by the position of the door in relation to the cabinet.

For elements that come with a direction, the code includes both directions (e.g. 45 cm base unit - code E4010451/2).

It is therefore necessary to specify the last figure - "1" for the RH direction, i.e. E4010451, or "2" for the LH direction, i.e. E4010452.

The RH or LH direction of the sinks is determined by the position of the bowls.

The prices indicated are expressed in units of Euro and exclude VAT and the WEEE fee.

Prices of the base units and columns are inclusive of the standard plinth.

The prices that apply to all custom-sized cabinets are indicated on the page "Surcharges for custom-sized elements".

In the event of handles requested with a different centre-to-centre distance compared to the standard for the model, the doors will be supplied without pre-drilled holes for the handles.

The colours in the pictures appearing in this price list are purely indicative and should not be used as reference.

COMPOSIZIONI SENZA ELETTRODOMESTICI E SENZA TOP

COMPOSITIONS WITHOUT HOUSEHOLD APPLIANCES AND WORKTOP

Tutte le composizioni richieste prive di elettrodomestici (frigo, forno, piano cottura, lavastoviglie o lavatrice), saranno aumentate di un importo netto pari a € 150 iva esclusa. Tale direttiva non si applica se la cucina contiene almeno due di questi elettrodomestici.

Tutte le composizioni richieste prive di top, saranno aumentate di un importo netto pari a € 100 iva esclusa.

All compositions requested without household appliances (fridge, oven, cooker hob, dishwasher or washing machine) shall be subject to a price increase of € 150 VAT excluded.

This measure does not apply if the kitchen contains at least two of the above-mentioned appliances.

All compositions requested without worktop shall be subject to a price increase of € 100 VAT excluded.

MAGGIORAZIONI PER ELEMENTI FUORI MISURA

SURCHARGES FOR CUSTOM-SIZED ELEMENTS

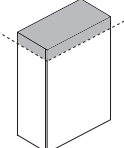
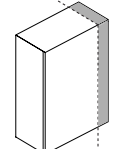
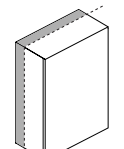
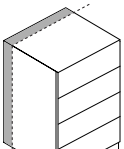
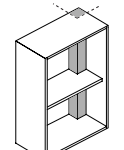
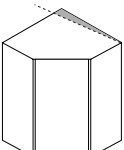
	DESCRIZIONE DESCRIPTION	MAGGIORAZIONE SURCHARGE		DESCRIZIONE DESCRIPTION	MAGGIORAZIONE SURCHARGE
	Riduzioni in altezza Height reduction			Basi angolo fuori squadra Out-of-plumb corner base units	
		Basi Base units + 25 %			
		Pensili Wall units + 25 %			
		Colonne Columns + 25 %			+ 28 %
	Riduzioni in larghezza Width reduction			Basi e sottolavelli con portabombola Base and sink base units with cylinder holder	
		Basi Base units + 28 %			
		Pensili Wall units + 28 %			
		Colonne Columns + 28 %			+ 20 €
	Riduzioni in profondità Depth reduction			Maggiorazioni per fianco scavato per inserimento piano cottura tra due basi (PPC opz. 011/012) Surcharge for digged side to insert cooking hob between two bases (PPC opt. 011/012)	
		Basi Base units + 18 %			
		Pensili Wall units + 18 %			
		Colonne Columns + 18 %			Cadauno each + 23 €
	Riduzioni per cassettera N.B.: modificabili solo in profondità fino a 31 cm al fianco Reductions for drawer unit Note: can only be modified depth-wise up to 31 cm on the side			Maggiorazioni per raggiatura top e mensola in laminato Surcharges for rounded edge on laminate worktop and shelf	
					Codice code T9STP + 35 €
	Taglio per pilastro N.B.: non realizzabile nei pensili con meccanismi Indent for pilaster Note: not feasible on wall units with mechanisms			Maggiorazione per inserimento tubo cappa (da sommare al prezzo del pensile) Surcharge for insertion of the hood pipe (to be added to the price of the wall unit)	
		Basi Base units Cod. T9SCB + 90 €			
		Pensili Wall units Cod. T9SCB + 90 €			
		Colonne Columns Cod. T9SCC + 130 €			+ 90 €
	Pensili angolo fuori squadra Out-of-plumb corner wall units			Maggiorazione per inserimento cappa non standard N.B.: verificare sempre la fattibilità dell'incasso con il nostro ufficio tecnico Surcharge for the insertion of a non-standard hood Note: always verify the feasibility of the installation	
					+ 90 €
					+ 28 %

La maggiorazione è da applicare al prezzo dell'elemento di serie più grande rispetto a quello delle dimensioni richieste.

Negli elementi fuori misura per motivi di lavorazione, l'estetica può risultare inferiore agli elementi di serie.

The surcharge applies to the price of the standard element that is next largest to that of the requested size.

Due to the processing involved, the aesthetic level of custom-sized elements may be slightly inferior to that of standard elements.

re≡ind

Rewind è il nuovo sistema cucina di Creo Kitchens. Ogni modello esprime possibilità diverse di vivere l'ambiente cucina, con un denominatore comune: la funzionalità estetica. Caratterizzata da un'infinita componibilità, il modello Rewind ha alcuni elementi che lo rendono unico e speciale, come le nuove maniglie di design create ad hoc dalla linea squadrata e le esclusive ante decorate artigianalmente.

Elementi a giorno tradizionali o in alluminio per uno stile più moderno, fianconi di spessore 76 mm dal design deciso, telai in alluminio costruiti per dare un frame continuo ai pensili chiusi sono solo alcuni dettagli distintivi di questa cucina pensata per il comfort e la praticità.

Tutte le ante hanno uno spessore di 22 mm e sono disponibili in nuove essenze: frassino creta, pine cipria, pine polar, faggio naturale, rovere gessato e noce, inediti e attuali colori anche per le laccature oltre alle possibilità classiche di Creo Kitchens.

La grande scelta di finiture e colori assicura la personalizzazione in configurazioni che si adattano a qualsiasi esigenza. Con Rewind ognuno può trovare il suo mondo: focolare domestico, esperienza sensoriale, luogo formale di ospitalità, spazio libero di condivisione.





CREO ECOLOGIC

IL GRUPPO LUBE HA SCELTO DI UTILIZZARE PER I COMPONENTI COSTITUENTI LE STRUTTURE DELLE CUCINE SOLO MATERIALE A BASSISSIMA EMISSIONE DI FORMALDEIDE: CONFORMI ALLO STANDARD F4STELLE SECONDO LA NORMA JIS, CERTIFICATO DAL MINISTERO GIAPPONESE, IL PIU' SEVERO IN MERITO ALLE NORMATIVE DI SALVAGUARDIA AMBIENTALE.

Regarding the production of its kitchen structure components, lube group has decided to only use materials featuring very low formaldehyde emissions complying with the 4-star standard, as defined by the jis regulation. This standard is certified by the japanese government-the most rigorous when it comes to environmental protection.

Rewind is the new kitchen system from Creo Kitchens. Each model expresses different ways of experiencing the kitchen, with one common denominator: aesthetic functionality. Characterised by limitless modularity, the Rewind model has several elements that make it special and unique, such as the new designer handles created ad hoc with a square form and exclusive hand-finished decoration.

Traditional or aluminium open elements for a more modern style, side panels 76 mm thick with a strong design and aluminium frames made to give a continuous frame to the closed wall units are just a few of the distinctive details of this kitchen, designed for comfort and practicality.

All the doors are 22 mm thick and are available in new woods: clay ash, pale pink pine, polar pine, natural beech, pinstriped oak and walnut, trendy and unusual colours for the lacquers too, as well as the classic Creo Kitchens colours. The great choice of finishes and colours ensures a high level of customisation and configurations to suit any requirement. With Rewind everyone can find their own world: domestic hearth, sensory experience, formal entertaining space or open space for sharing.

re≡ind melaminico

SP. 22 MM

N.B.: i prezzi sono espressi all'unità di euro (iva esclusa)

CARATTERISTICHE TECNICHE

ANTE E FRONTALI CASSETTI anta con cornice in massello di frassino tinto a poro aperto sp.22 mm e cartella in melaminico sp.18 mm nei colori: frassino creta (opz.2401), pine cipria (opz.3051), pine polar (opz.3052), faggio naturale (opz.1569), rovere grigio gessato (opz.5330), noce brown (opz.2371)

ANTE VETRO telaio in alluminio finitura titanio e brill sp.22 mm, vetro colorato sp.4 mm (per colori vedi pag.17)

GOLA tipo "ELLE"

N.B.: per le finiture gole vedi pag.23



MANIGLIE vedi pag.28-29

STRUTTURE
ANTE: PINE POLAR, FAGGIO NATURALE
 nobilitato perla d'oriente (opz.940), schiena e ripiano bianco (opz.001)

ANTA: PINE CIPRIA
 nobilitato visone (opz.948M) schiena e ripiano visone (opz.948M)

ANTE: FRASSINO CRETA, NOCE BROWN
 nobilitato fango (opz.8860) schiena e ripiano fango (opz.8860)

ANTA: ROVERE GRIGIO GESSATO
 nobilitato lavagna (opz.9620) schiena e ripiano lavagna (opz.9620)



MENSOLE
 di serie: altezza 3,8 cm in nobilitato perla d'oriente (opz.940), visone (opz.948M), fango (opz.8860), lavagna (opz.9620)
 a richiesta: altezza 3,8 cm in nobilitato frassino creta (opz.2401), pine cipria (opz.3051), pine polar (opz.3052), faggio naturale (opz.1569), rovere grigio gessato (opz.5330), noce brown (opz.2371)

ZOCCOLI
 di serie: altezza 13 cm in pvc ricoperti in melamina finitura acciaio (opz.407)
 a richiesta: altezza 13 cm in alluminio finitura brill (opz.412), titanio ossidato (opz.414), vedi maggiorazioni pag.31
 altezza 13 cm in alluminio verniciato a polvere finitura opaca nei colori vedi pag.31

TECHNICAL SPECIFICATIONS

DOORS AND DRAWERS FRONTS

door with frame in solid ash with an open pore finish, 22 mm thick with 18 mm thick melamine panel in the following colours: clay ash (opt.2401), pale pink pine (opt.3051), polar pine (opt.3052), natural beech (opt.1569), pinstripe grey oak (opt.5330), brown walnut (opt.2371)

GLASS DOORS

aluminium frame in titanium and brill finish, 22 mm thick, coloured glass 4 mm thick (for colours see page 17)

FINGER RAIL

"L" shaped

NOTE: for the finger rail finishes see page 23



HANDLES

see page 28-29

CARCASSES

DOORS: POLAR PINE, NATURAL BEECH
 oriental pearl (opt.940), white back panel and shelf (opt.001)

DOOR: PALE PINK PINE
 mink (opt.948M), mink back panel and shelf (opt.948M)

DOORS: CLAY ASH, BROWN WALNUT
 mud (opt.8860), mud back panel and shelf (opt.8860)

DOOR: PINSTRIPE GREY OAK
 slate grey (opt.9620), slate grey back panel and shelf (opt.9620)

SHELVES

standard: height 3.8 cm, in oriental pearl (opt.940), mink (opt.948M), mud (opt.8860), slate grey (opt.9620)

on request: height 3.8 cm, in clay ash (opt.2401), pale pink pine (opt.3051), polar pine (opt.3052), natural beech (opt.1569), pinstripe grey oak (opt.5330) and brown walnut (opt.2371)

PLINTHS

standard: height 13 cm, melamine-faced PVC with steel finish (opt.407)

on request: height 13 cm, in aluminium with brill finish (opt.412) oxidised titanium (opt.414), see surcharges on page 31
 height 13 cm, in matt powder-coated aluminium for colours see page 31



rewind melaminico melamine

Neck cod. **K36**
 Bridge cod. **K33**

ante con cornice in massello di frassino tinto a poro aperto e cartella in melaminico
 doors with frame in stained solid ash with open pore finish and melamine panel



frassino creta (opz.2401)
 clay ash (opt.2401)



pine cipria (opz.3051)
 pale pink pine (opt.3051)



noce brown (opz.2371)
 brown walnut (opt.2371)

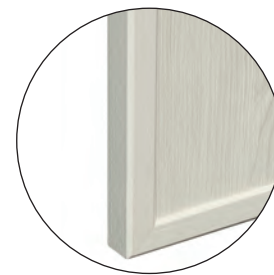

particolare anta anteriore
 front edge door detail



particolare anta posteriore
 rear edge door detail



faggio naturale (opz.1569)
 natural beech (opt.1569)



rovere grigio gessato (opz.5330)
 pinstripe grey oak (opt.5330)



pine polar (opz.3052)
 polar pine (opt.3052)

SP. 22 MM
 TH. 22 MM

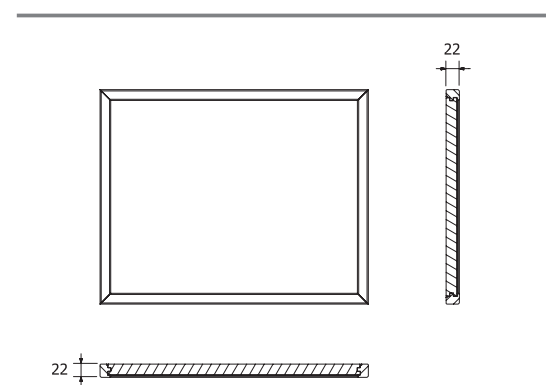

re≲ind laccato opaco

SP. 22 MM

N.B.: i prezzi sono espressi all'unità di euro (iva esclusa)

CARATTERISTICHE TECNICHE

ANTE E FRONTALI CASSETTI anta in mdf sp.22 mm pantografata e laccata con finitura opaca microstrutturata
N.B.: per i colori vedi pag.15

ANTE VETRO telaio in alluminio finitura titanio e brill sp.22 mm, vetro colorato sp.4 mm (per colori vedi pag.17)

GOLA tipo "ELLE"
N.B.: per le finiture gole vedi pag.23



MANIGLIE
vedi pag.28-29

STRUTTURE

ANTE: PLATINO, NOCCIOLA
 nobilitato perla d'oriente (opz.940), schiena e ripiano bianco (opz.001)

ANTA: CUOIO
 nobilitato fango (opz.8860) schiena e ripiano fango (opz.8860)

ANTA: GRIGIO PIOMBO
 nobilitato lavagna (opz.9620) schiena e ripiano lavagna (opz.9620)

ANTA: POLVERE
 nobilitato bianco (opz.001) schiena e ripiano bianco (opz.001)

ANTA: CANAPA
 nobilitato devalè finitura grafis (opz.796) schiena e ripiano bianco (opz.001)



MENSOLE altezza 3,8 cm laccate come ante

ZOCCOLI

di serie: altezza 13 cm in pvc ricoperti in melamina finitura acciaio (opz.407)

a richiesta: altezza 13 cm in alluminio finitura brill (opz.412), titanio ossidato (opz.414), **vedi maggiorazioni pag.31**
 altezza 13 cm in alluminio verniciato a polvere finitura opaca nei colori **vedi pag.31**

re≡ind matt lacquered

Neck cod. **K37**
Bridge cod. **K34**

TH. 22 MM

Note: the prices are expressed in units of euro (vat excluded)

TECHNICAL SPECIFICATIONS

DOORS AND DRAWERS FRONTS

22 mm thick MDF door with micro-structured matt lacquer finish

NOTE: for the colours see page 15

GLASS DOORS

aluminium frame in titanium and brill finish, 22 mm thick, coloured glass 4 mm thick (for colours see page 17)

FINGER RAIL

"L" shaped

NOTE: for the finger rail finishes see page 23



HANDLES

see page 28-29

CARCASSES

DOORS: PLATINUM, HAZEL
oriental pearl (opt.940), white back panel and shelf (opt.001)

DOOR: LEATHER
mud (opt.8860), mud back panel and shelf (opt.8860)

DOOR: LEAD GREY
slate grey (opt.9620), slate grey back panel and shelf (opt.9620)

DOOR: POWDER
white (opt.001), white back panel and shelf (opt.001)

DOOR: HEMP
devalè with grafis finish (opt.796), white back panel and shelf (opt.001)

SHELVES

height 3.8 cm, lacquered in same finish as doors

PLINTHS

standard: height 13 cm, melamine-faced PVC with steel finish (opt.407)

on request: height 13 cm, in aluminium with brill finish (opt. 412) oxidised titanium (opt. 414), see surcharges on page 31
height 13 cm, in matt powder-coated aluminium for colours see page 31



rewind

laccato opaco

matt lacquered

Neck cod. **K37**
 Bridge cod. **K34**

ante laccate con finitura opaca microstrutturata

lacquered doors with matt micro-structured finish

N.B.: i colori riportati di seguito sono quelli consigliati per gli abbinamenti con le ante in melaminico

Note.: the colours given below are those recommended for matching with melamine doors



cuoio opaco (opz.8897)
 in abbinamento con
frassino creta (opz.2401)
 matt leather (opt.8897)
 in combination with
 clay ash (opt.2401)



polvere opaco (opz.9539)
 in abbinamento con
pine cipria (opz.3051)
 matt powder (opt.9539)
 in combination with
 pale pink pine (opt.3051)



canapa opaco (opz.8531)
 in abbinamento con
noce brown (opz.2371)
 matt hemp (opt. 8531)
 in combination with
 brown walnut (opt.2371)

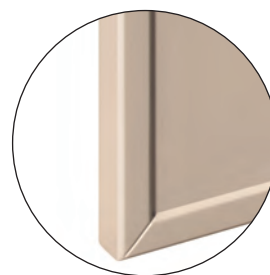

particolare anta anteriore
 front edge door detail

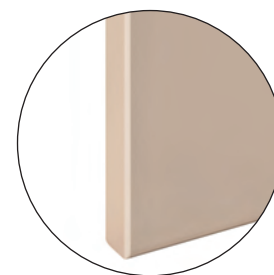

particolare anta posteriore
 rear edge door detail



nocciola opaco (opz.7775)
 in abbinamento con
faggio naturale (opz.1569)
 matt hazel (opt.7775)
 in combination with
 natural beech (opt. 1569)



grigio piombo opaco (opz.9537)
 in abbinamento con
rovere grigio gessato (opz.5330)
 matt lead grey
 (opt.9537)
 in combination with
 pinstripe grey oak (opt.5330)



platino opaco (opz.7773)
 in abbinamento con
pine polar (opz.3052)
 matt platinum (opt.7773)
 in combination with
 polar pine (opt.3052)

SP. 22 MM
TH. 22 MM

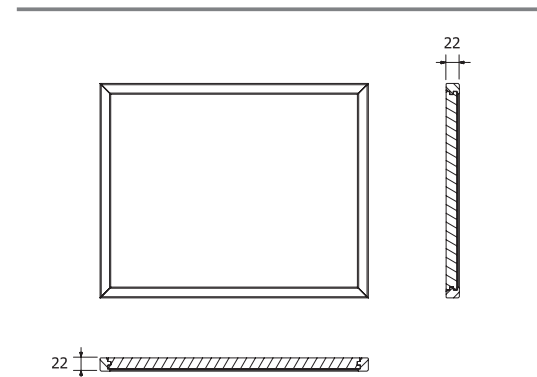

N.B.: ante disponibili anche in tutti i colori laccato opaco della Tabella laccati Creo Kitchens (vedi inserto allegato)

Note: doors are also available in all matt lacquer colours on the Creo Kitchens colour chart (see insert attached)



re∑ind vetro glass

ante vetro con telaio alluminio finitura brill e titanio
glass doors with aluminium frame in brill and titanium finish

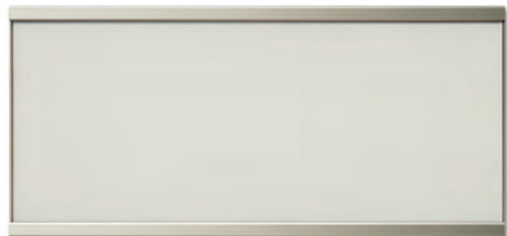

anta centrale (opz.C)
central door (opt.C)

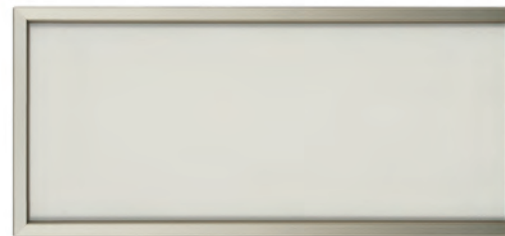

anta laterale sx (opz.S)
LH side door (opt.S)



anta laterale dx (opz.D)
RH side door (opt.D)

N.B.: anta centrale (di serie) utilizzabile singolarmente o in combinazione con le ante laterali sx/dx
Note: central door (as standard) can be used individually or in combination with LH/RH side doors

telaio frame



brill
brill



titanio
titanium

N.B.: ante laterali sx/dx da utilizzare esclusivamente inizio/fine composizione
Note: LH/RH side doors to be used exclusively at the start/end of the composition

colori vetri satinati satin glasses colours



vetro creta
- telaio brill (opz.BRCR_)
- telaio titanio (opz.TRCR_)
in abbinamento con frassino creta (opz.2401)
clay glass
- brill frame (opt.BRCR_)
- titanium frame (opt.TRCR_)
in combination with clay ash (opt.2401)

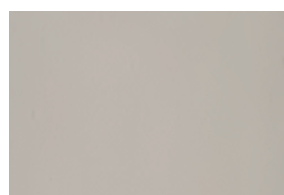

vetro cipria
- telaio brill (opz.BRCI_)
- telaio titanio (opz.TRCI_)
in abbinamento con pine cipria (opz.3051)
pale pink glass
- brill frame (opt.BRCI_)
- titanium frame (opt.TRCI_)
in combination with pale pink pine (opt.3051)



vetro natur
- telaio brill (opz.BRNA_)
- telaio titanio (opz.TRNA_)
in abbinamento con faggio naturale (opz.1569)
natural glass
- brill frame (opt.BRNA_)
- titanium frame (opt.TRNA_)
in combination with natural beech (opt.1569)



vetro arena
- telaio brill (opz.BRAR_)
- telaio titanio (opz.TRAR_)
in abbinamento con rovere grigio gessato (opz.5330)
arena glass
- brill frame (opt.BRAR_)
- titanium frame (opt.TRAR_)
in combination with pinstripe grey oak (opt.5330)



vetro polar
- telaio brill (opz.BRPO_)
- telaio titanio (opz.TRPO_)
in abbinamento con pine polar (opz.3052)
polar glass
- brill frame (opt.BRPO_)
- titanium frame (opt.TRPO_)
in combination with polar pine (opt.3052)

colori vetri semitrasparenti semi-transparent glasses colours



vetro bronzato
- telaio brill (opz.BRBR_)
- telaio titanio (opz.TRBR_)
in abbinamento con noce brown (opz.2371)
bronzed glass
- brill frame (opt.BRBR_)
- titanium frame (opt.TRBR_)
in combination with brown walnut (opt.2371)

SP. 22 MM
TH. 22 MM

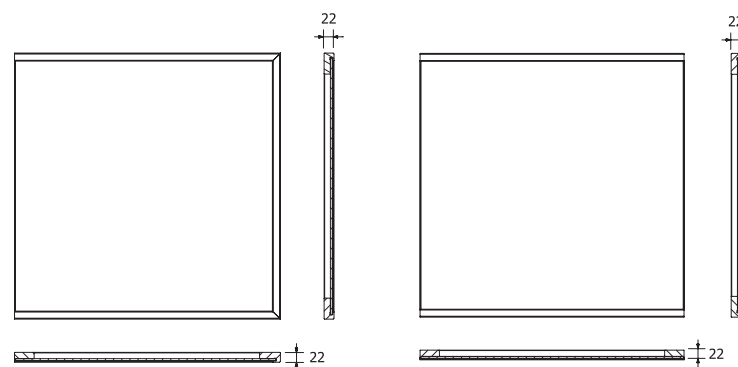

anta MODULO LATERALE
door SIDE MODULE

anta MODULO CENTRALE
door CENTRAL MODULE

N.B.: i prezzi sono espressi all'unità di euro (iva esclusa)
Note: the prices are expressed in units of euro (vat excluded)

CARATTERISTICHE TECNICHE

ANTE CON DECORO anta in mdf sp.22 mm verniciata con colori acrilici su una superficie materica costituita da calce e polvere di marmo protetti da trasparente poliuretano. Retro laccato opaco in tinta.

MANIGLIA senza maniglia

STRUTTURE
nobilitato perla d'oriente (opz.940), schiena e ripiano bianco (opz.001)
nobilitato visone (opz.948M) schiena e ripiano visone (opz.948M)
nobilitato fango (opz.8860) schiena e ripiano fango (opz.8860)
nobilitato lavagna (opz.9620) schiena e ripiano lavagna (opz.9620)



MENSOLE altezza 3,8 cm in nobilitato perla d'oriente (opz.940), visone (opz.948M), fango (opz.8860), lavagna (opz.9620)

ZOCCOLI
di serie: altezza 13 cm in pvc ricoperti in melamina finitura acciaio (opz.407)
a richiesta: altezza 13 cm in alluminio finitura brill (opz.412), titanio ossidato (opz.414), [vedi maggiorazioni pag.31](#)
altezza 13 cm in alluminio verniciato a polvere finitura opaca nei colori [vedi pag.31](#)

TECHNICAL SPECIFICATIONS

DOORS W/DECORATION
22 mm thick MDF door with acrylic colours on a textured surface made from lime and marble dust protected with a transparent polyurethane coating. Matching matt lacquered rear panel

HANDLE without handle

CARCASSES
oriental pearl (opt.940), white back panel and shelf (opt.001)
mink (opt.948M), mink back panel and shelf (opt.948M)
mud (opt.8860), mud back panel and shelf (opt.8860)
slate grey (opt.9620), slate grey back panel and shelf (opt.9620)

SHELVES
height 3.8 cm, in oriental pearl (opt.940), mink (opt.948M), mud (opt.8860), slate grey (opt.9620)

PLINTHS
standard: height 13 cm, melamine-faced PVC with steel finish (opt.407)
on request: height 13 cm, in aluminium with brill finish (opt. 412) oxidised titanium (opt. 414), [see surcharges on page 31](#)
height 13 cm, in matt powder-coated aluminium in the following colours [see page 31](#)

IN ABBINAMENTO ALL'ANTA FRASSINO CRETA DOOR COMBINATION CLAY ASH



TIPO "A" creta + retro laccato cuoio opaco (opz.2401A)
TYPE "A" clay + rear panel in matt leather lacquer (opt.2401A)



TIPO "B" creta + retro laccato cuoio opaco (opz.2401B)
TYPE "B" clay + rear panel in matt leather lacquer (opt.2401B)

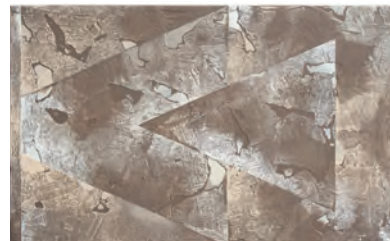

TIPO "C" creta + retro laccato cuoio opaco (opz.2401C)
TYPE "C" clay + rear panel in matt leather lacquer (opt.2401C)

IN ABBINAMENTO ALL'ANTA PINE CIPRIA DOOR COMBINATION PALE PINK PINE



TIPO "A" cipria + retro laccato polvere opaco (opz.3051A)
TYPE "A" pale pink + rear panel in matt powder lacquer (opt.3051A)



TIPO "B" cipria + retro laccato polvere opaco (opz.3051B)
TYPE "B" pale pink + rear panel in matt powder lacquer (opt.3051B)



TIPO "C" cipria + retro laccato polvere opaco (opz.3051C)
TYPE "C" pale pink + rear panel in matt powder lacquer (opt.3051C)

IN ABBINAMENTO ALL'ANTA FAGGIO NATURALE DOOR COMBINATION NATURAL BEECH



TIPO "A" natur + retro laccato nocciola opaco (opz.1569A)
TYPE "A" natural + rear panel in matt hazel lacquer (opt.1569A)



TIPO "B" natur + retro laccato nocciola opaco (opz.1569B)
TYPE "B" natural + rear panel in matt hazel lacquer (opt.1569B)



TIPO "C" natur + retro laccato nocciola opaco (opz.1569C)
TYPE "C" natural + rear panel in matt hazel lacquer (opt.1569C)

IN ABBINAMENTO ALL'ANTA ROVERE GRIGIO GESSATO DOOR COMBINATION PINSTRIPE GREY OAK



TIPO "A" arena + retro laccato piombo opaco (opz.5330A)
TYPE "A" sand + rear panel in matt lead lacquer (opt.5330A)

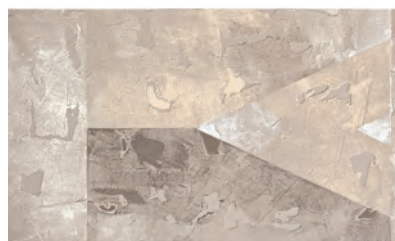

TIPO "B" arena + retro laccato piombo opaco (opz.5330B)
TYPE "B" sand + rear panel in matt lead lacquer (opt.5330B)



TIPO "C" arena + retro laccato piombo opaco (opz.5330C)
TYPE "C" sand + rear panel in matt lead lacquer (opt.5330C)

IN ABBINAMENTO ALLE ANTE PINE POLAR E NOCE BROWN DOORS COMBINATION PINE POLAR AND WALNUT BROWN



TIPO "A" polar + retro laccato platino opaco (opz.3052A)
TYPE "A" polar + rear panel in matt platinum lacquer (opt.3052A)



TIPO "B" polar + retro laccato platino opaco (opz.3052B)
TYPE "B" polar + rear panel in matt platinum lacquer (opt.3052B)



TIPO "C" polar + retro laccato platino opaco (opz.3052C)
TYPE "C" polar + rear panel in matt platinum lacquer (opt.3052C)

TIPOLOGIE DI DECORO DECORATION TYPES

Tipo "A" Type "A"

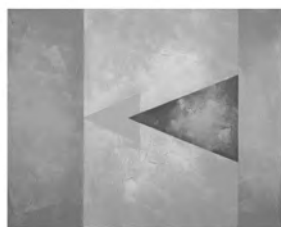

357X447

Tipo "B" Type "B"



357X447

Tipo "C" Type "C"



357X447

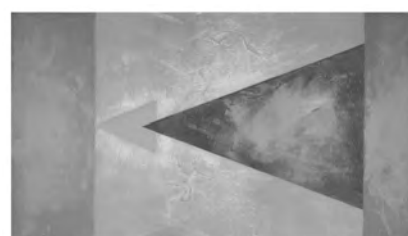

357X597



357X597



357X597

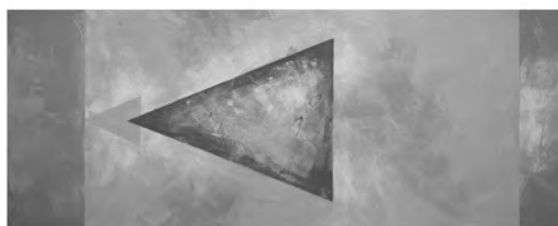

357X897



357X897



357X897

TIPOLOGIE DI DECORO DECORATION TYPES

Tipo "A" Type "A"

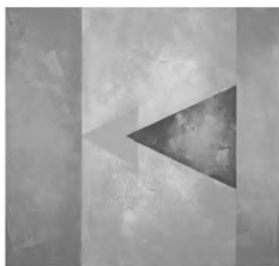

477X447

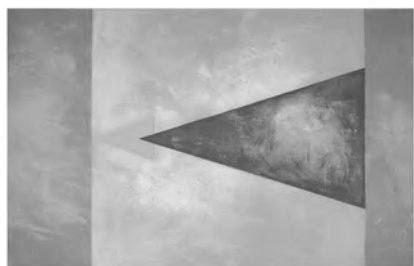

477X597

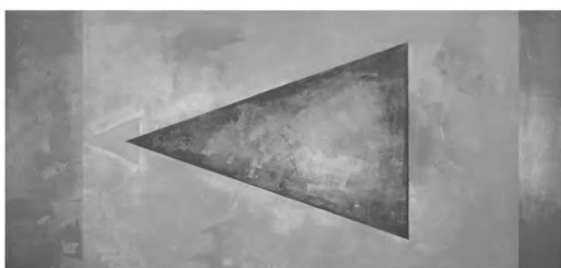

477X897

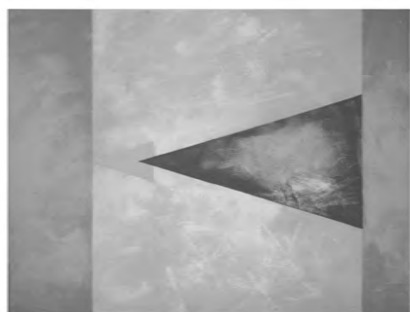

597X597

Tipo "B" Type "B"



477X447



477X597



477X897



597X597

Tipo "C" Type "C"



477X447

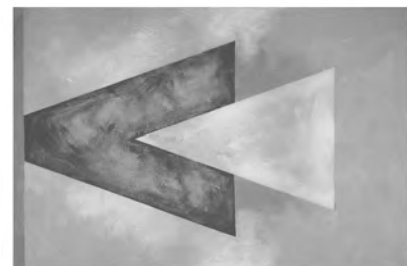

477X597



477X897



597X597



Neck

FINITURE GOLE

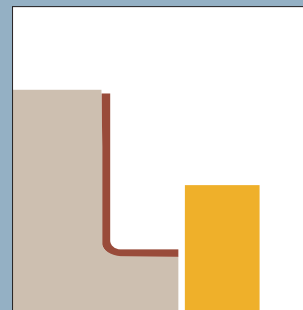

GOLA TIPO "ELLE"

"ELLE" TYPE FINGER RAIL

FINITURE GOLE SPAZZOLATE FINGER RAILS BRUSHED FINISHES

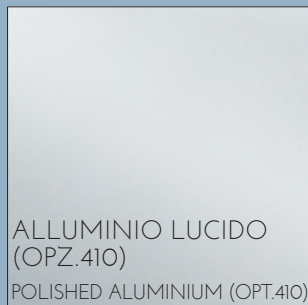

ALLUMINIO LUCIDO
(OPZ.410)
POLISHED ALUMINIUM (OPT.410)



TITANIO OSSIDATO
(OPZ.414)
TITANIUM OXIDIZED (OPT.414)

FINITURE GOLE VERNICIATE A POLVERE OPACHE MATT FINGER RAILS POWDER COATED FINISHES

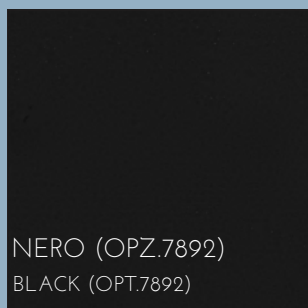

NERO (OPZ.7892)
BLACK (OPT.7892)

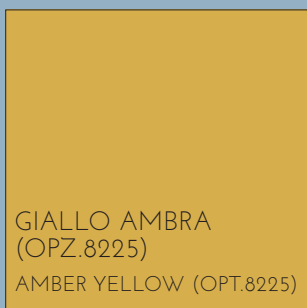

GIALLO AMBRA
(OPZ.8225)
AMBER YELLOW (OPT.8225)

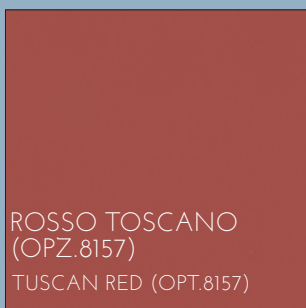

ROSSO TOSCANO
(OPZ.8157)
TUSCAN RED (OPT.8157)

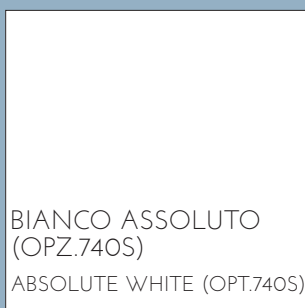

BIANCO ASSOLUTO
(OPZ.740S)
ABSOLUTE WHITE (OPT.740S)

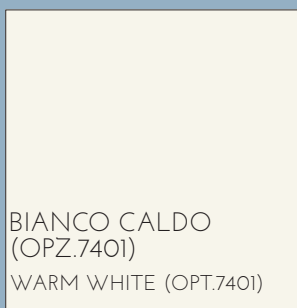

BIANCO CALDO
(OPZ.7401)
WARM WHITE (OPT.7401)



BLU FIORDALISO
(OPZ.8377)
CORNFLOWER BLUE (OPT.8377)

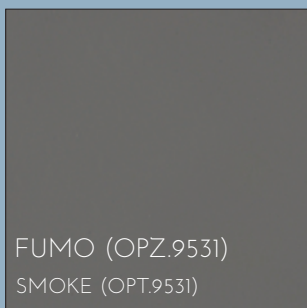

FUMO (OPZ.9531)
SMOKE (OPT.9531)

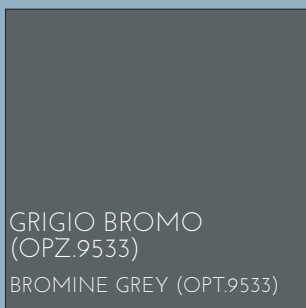

GRIGIO BROMO
(OPZ.9533)
BROMINE GREY (OPT.9533)

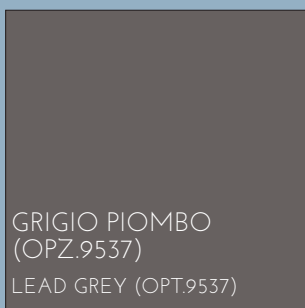

GRIGIO PIOMBO
(OPZ.9537)
LEAD GREY (OPT.9537)



VERDE POSITANO
(OPZ.8471)
POSITANO GREEN (OPT.8471)



CASTORO (OPZ.8907)
BEAVER (OPT.8907)

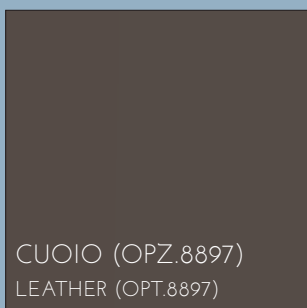

CUOIO (OPZ.8897)
LEATHER (OPT.8897)

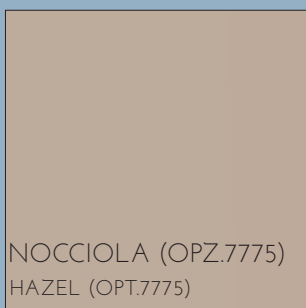

NOCCIOLA (OPZ.7775)
HAZEL (OPT.7775)

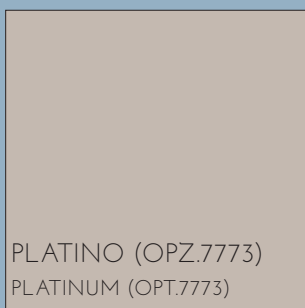

PLATINO (OPZ.7773)
PLATINUM (OPT.7773)







POLVERE (OPZ.9539)
DUST (OPT.9539)



TERRA DI SIENA
(OPZ.8161)
SIENA EARTH (OPT.8161)

GOLA "ELLE" ORIZZONTALE SOTTOTOP

UNDERMOUNT HORIZONTAL "ELLE" FINGER RAIL

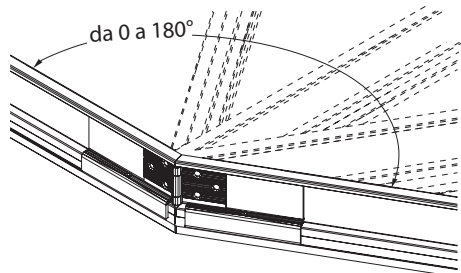
	COD.	€		COD.	€	
<p>Gola sottotop tipo "A" N.B.: costo gola già compreso nel prezzo delle basi Type "A" undermount finger rail Note: finger rail cost already included in base unit price</p> 			<p>Angolo interno a 90° per gola tipo "A" N.B.: costo angolare già compreso nel prezzo delle basi angolo 90° interior corner for "A" type finger rail Note: corner piece cost already included in corner unit price</p> 			
	al ml per lm	G950010		23	cadauno each	G950050
<p>Terminale aperto dx o sx per gola tipo "A" da utilizzare a fine composizione RH or LH open end for type "A" finger rail to be placed at the end of the composition</p> 			<p>Angolare con snodo per unione fuori squadra per gola tipo "A" Corner piece with joint for out-of-plumb joining for type "A" finger rail</p> 			
	in alluminio aluminium					
	terminale DX RH end	G950021		23		
	terminale SX LH end	G950022		23		
	in plastica (solo finitura opz.410) plastic (only finish opt.410)					
	terminale DX RH end	G950041		8		
terminale SX LH end	G950042	8				
<p>Terminale chiuso dx o sx per gola tipo "A" da utilizzare solo tra basi e colonne RH or LH closure for type "A" finger rail to be placed only between base units and column</p> 			<p>da 0 a 180°</p> 			
	in alluminio aluminium					
	terminale DX RH end	G950031		23		
	terminale SX LH end	G950032		23		
	in plastica (solo finitura opz.410) plastic (only finish opt.410)					
	terminale DX RH end	G950045		8		
terminale SX LH end	G950046	8				
				G950060	57	



GOLA "ELLE" ORIZZONTALE INTERMEDIA

INTERMEDIATE HORIZONTAL "ELLE" FINGER RAIL

GOLE "ELLE" VERTICALI PER COLONNE

VERTICAL "ELLE" FINGER RAILS FOR COLUMNS

	COD.	€
<p>Gola intermedia tipo "B" N.B.: costo gola già compreso nel prezzo delle basi con cassetti o cestoni Type "B" intermediate finger rail Note: finger rail cost already included in price base unit with drawers or deep drawers</p> 	G950110	33
<p>Terminale aperto dx o sx per gola tipo "B" da utilizzare a fine composizione RH or LH open end for type "B" finger rail to be placed at the end of the composition</p> 		
<p>in alluminio aluminium</p> <p>terminale DX RH end</p> <p>terminale SX LH end</p>	G950121	28
	G950122	28
<p>in plastica (solo finitura opz.410) plastic (only finish opt.410)</p> <p>terminale DX RH end</p> <p>terminale SX LH end</p>	G950141	8
	G950142	8
<p>Terminale chiuso dx o sx per gola tipo "B" da utilizzare solo tra cassettiere e lavastoviglie/colonne RH or LH closure for type "B" finger rail to be placed only between drawer units and dishwasher/columns</p> 		
<p>in alluminio aluminium</p> <p>terminale DX RH end</p> <p>terminale SX LH end</p>	G950131	28
	G950132	28
<p>in plastica (solo finitura opz.410) plastic (only finish opt.410)</p> <p>terminale DX RH end</p> <p>terminale SX LH end</p>	G950145	8
	G950146	8

	COD.	€
<p>Mezza gola verticale tipo "C" (completa di distanziale) Type "C" half vertical finger rail (complete with spacer)</p>  <p>sezione mezza gola tipo "C" cross section of type "C" finger rail</p>		
<p>pie di H 13 feet H 13</p> <p>H 96</p> <p>H 132</p> <p>H 204</p> <p>H 228</p>	G950310	63
	G950330	83
	G950350	123
	G950370	136
<p>Gola verticale intermedia tipo "D" (completa di distanziale) Type "D" intermediate vertical finger rail (complete with spacer)</p>  <p>sezione gola tipo "D" cross section of type "D" finger rail</p>		
<p>pie di H 13 feet H 13</p> <p>H 96</p> <p>H 132</p> <p>H 204</p> <p>H 228</p>	G950410	63
	G950430	83
	G950450	123
	G950470	136
<p>Gola verticale laterale tipo "E" (completa di distanziale) Type "E" lateral vertical finger rail (complete with spacer)</p>  <p>sezione gola tipo "E" cross section of type "E" finger rail</p>		
<p>pie di H 13 feet H 13</p> <p>H 96</p> <p>H 132</p> <p>H 204</p> <p>H 228</p>	G950510	63
	G950530	83
	G950550	123
	G950570	136

NOZIONI UTILI - gole "elle" orizzontali per basi

USEFUL INFORMATION - HORIZONTAL "ELLE" FINGER RAILS FOR BASE UNITS

VISTA FRONTALE ZOCCOLO H 13 PER BASI H 88

FRONT VIEW PLINTH H 13 FOR BASE UNITS H 88

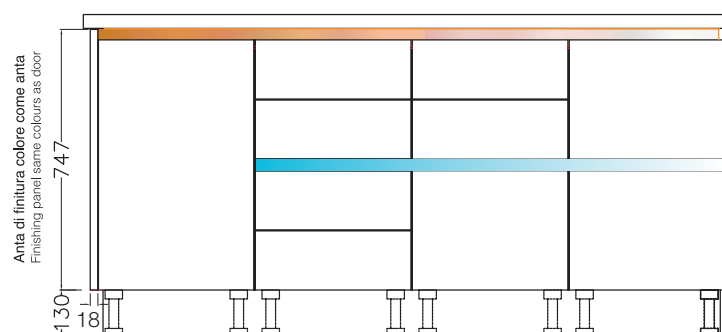
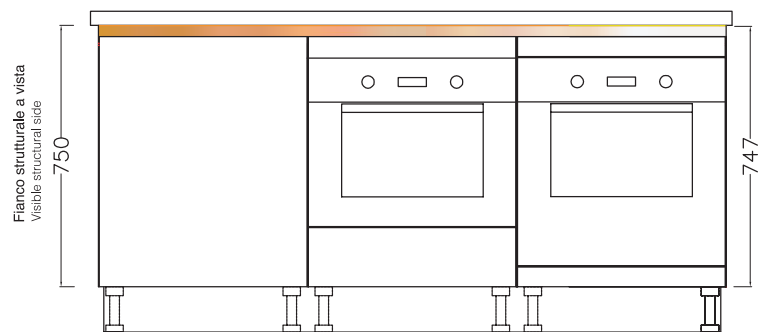

VISTA LATERALE (sezione) ZOCCOLO H 13 PER BASI H 88

SIDE VIEW (CROSS SECTION) PLINTH H 13 FOR BASE UNITS H 88

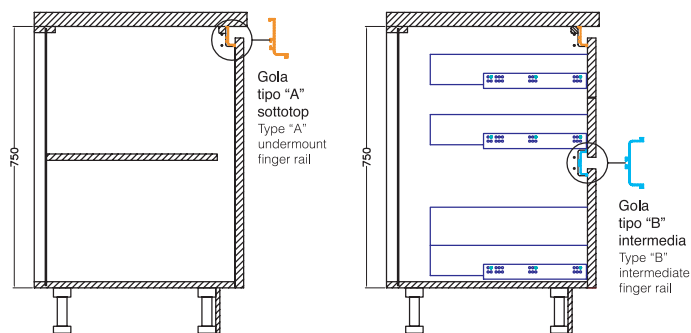

VISTA DALL'ALTO

TOP VIEW

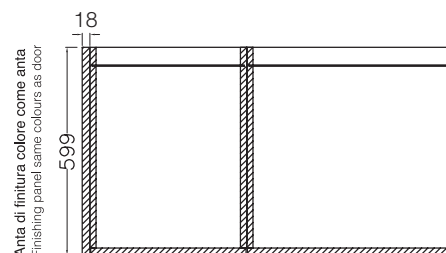
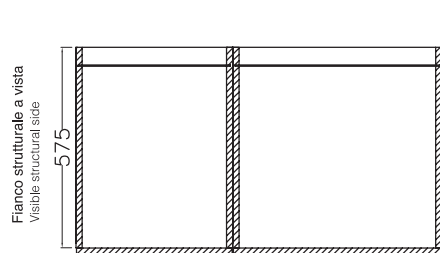

Composizione con ante di finitura laterali: alla dimensione finale della cucina, sommare sempre lo spessore delle ante di finitura (ogni anta 18 mm)

Composition with side finishing panels: to the final size of the kitchen, always add the thickness of the finishing panels (each panel 18 mm)

NOZIONI UTILI - gole "elle" verticali per colonne

USEFUL INFORMATION - VERTICAL "ELLE" FINGER RAILS FOR COLUMNS

VISTA FRONTALE ZOCCOLO H 13

FRONT VIEW PLINTH H 13

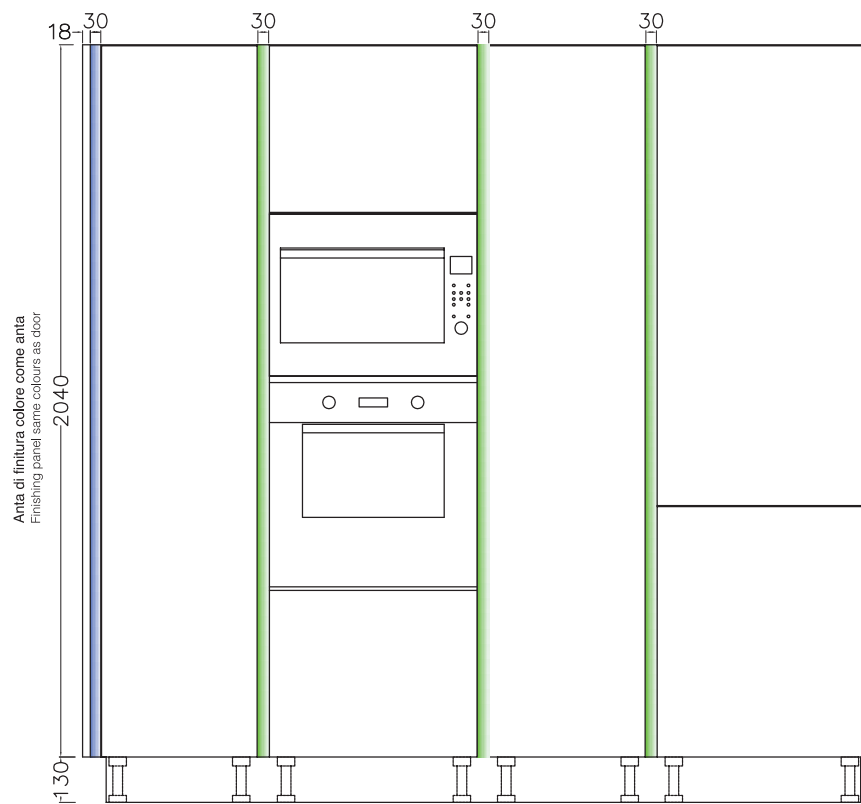

VISTA DALL'ALTO

TOP VIEW

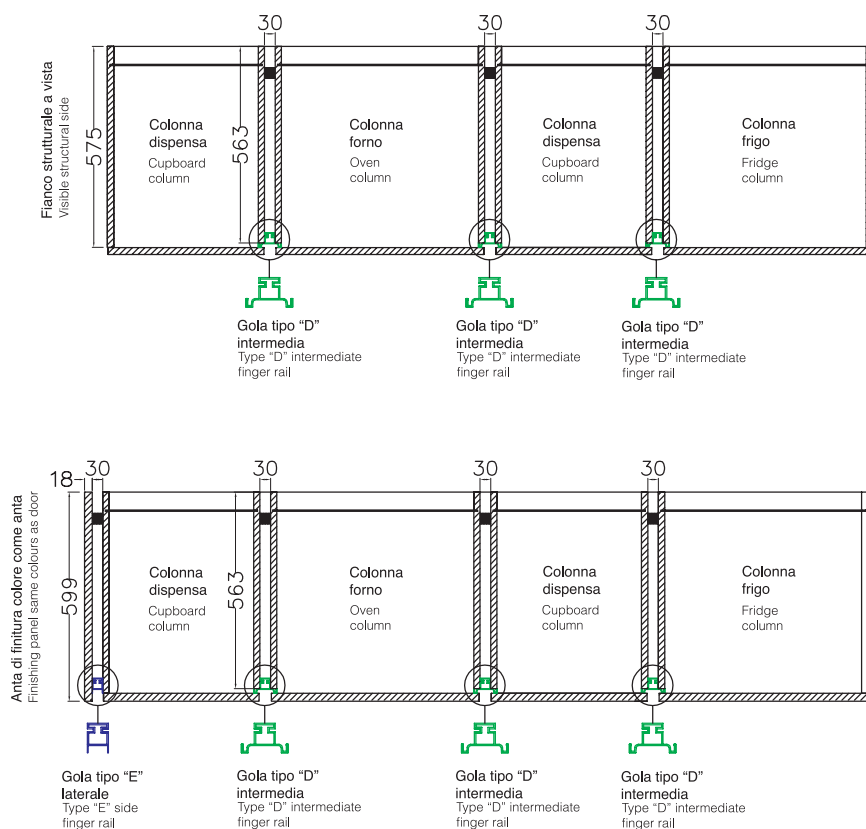

Composizione fianco strutturale a vista come anta: alla dimensione finale della cucina, sommare sempre lo spessore dei distanziali tra le colonne (ogni distanziale 3 cm)

Composition with visible side panel to match door: to the final size of the kitchen, always add the thickness of the spacers between the two columns (each spacer 3 cm)

Composizione con ante di finitura laterali, alla dimensione finale della cucina, sommare sempre lo spessore dei distanziali tra le colonne (ogni distanziale 3 cm) e lo spessore delle ante di finitura (ogni anta 18 mm)

Composition with side finishing panels to the final size of the kitchen, always add the thickness of the spacer between the two columns (each spacer 3 cm) and the thickness of the finishing panels (each panel 18 mm)

DI SERIE STANDARD



Maniglia 587 finitura titanio
 anta da L 30 a L 90 → passo 160 mm
N.B.: per gli elementi da 15 utilizzare la maniglia KL passo 32 mm (vedi pag.29)

Handle 587 titanium finish
 door from W 30 to W 90 → centre-to-centre distance 160 mm
NOTE: use KL handle with centre-to-centre distance 32 mm for 15 cm elements (see page 29)

A RICHIESTA ON REQUEST



Maniglia 588 finitura cromo opaco
 elementi da L 15 → Pomo
 anta da L 30 a L 60 → passo 160 mm
 anta L 90 → passo 320 mm

Handle 588 matt chrome finish
 elements W 15 → Knob hole
 door from W 30 to W 60 → centre-to-centre distance 160 mm
 door W 90 → centre-to-centre distance 320 mm



Maniglia K03 finitura acciaio satinato
 anta L 15 → passo 32 mm
 anta da L 30 a L 90 → passo 160 mm

Handle K03 satin steel finish
 door W 15 → centre-to-centre distance 32 mm
 door from W 30 to W 90 → centre-to-centre distance 160 mm



Maniglia 58FC finitura supporti nichel satinato
 inserto in tinta con anta frassino creta
 anta L 15 → passo 64 mm
 anta da L 30 a L 60 → passo 160 mm
 anta L 90 → passo 320 mm

Handle 58FC satin nickel finish supports
 insert match with clay ash door
 door W 15 → centre-to-centre distance 64 mm
 door from W 30 to W 60 → centre-to-centre distance 160 mm
 door W 90 → centre-to-centre distance 320 mm



Maniglia 58FN finitura supporti nichel satinato
 inserto in tinta con anta faggio naturale
 anta L 15 → passo 64 mm
 anta da L 30 a L 60 → passo 160 mm
 anta L 90 → passo 320 mm

Handle 58FN satin nickel finish supports
 insert match with natural beech door
 door W 15 → centre-to-centre distance 64 mm
 door from W 30 to W 60 → centre-to-centre distance 160 mm
 door W 90 → centre-to-centre distance 320 mm



Maniglia 58NB finitura supporti nichel satinato
 inserto in tinta con anta noce brown
 anta L 15 → passo 64 mm
 anta da L 30 a L 60 → passo 160 mm
 anta L 90 → passo 320 mm

Handle 58NB satin nickel finish supports
 insert match with brown walnut door
 door W 15 → centre-to-centre distance 64 mm
 door from W 30 to W 60 → centre-to-centre distance 160 mm
 door W 90 → centre-to-centre distance 320 mm



Maniglia 58PC finitura supporti nichel satinato
 inserto in tinta con anta pine cipria
 anta L 15 → passo 64 mm
 anta da L 30 a L 60 → passo 160 mm
 anta L 90 → passo 320 mm

Handle 58PC satin nickel finish supports
 insert match with pale pink pine door
 door W 15 → centre-to-centre distance 64 mm
 door from W 30 to W 60 → centre-to-centre distance 160 mm
 door W 90 → centre-to-centre distance 320 mm



Maniglia 58PP finitura supporti nichel satinato
 inserto in tinta con anta pine polar
 anta L 15 → passo 64 mm
 anta da L 30 a L 60 → passo 160 mm
 anta L 90 → passo 320 mm

Handle 58PP satin nickel finish supports
 insert match with polar pine door
 door W 15 → centre-to-centre distance 64 mm
 door from W 30 to W 60 → centre-to-centre distance 160 mm
 door W 90 → centre-to-centre distance 320 mm



Maniglia 58RG finitura supporti nichel satinato
 inserto in tinta con anta rovere grigio gessato
 anta L 15 → passo 64 mm
 anta da L 30 a L 60 → passo 160 mm
 anta L 90 → passo 320 mm

Handle 58RG satin nickel finish supports
 insert match with pinstripe grey oak door
 door W 15 → centre-to-centre distance 64 mm
 door from W 30 to W 60 → centre-to-centre distance 160 mm
 door W 90 → centre-to-centre distance 320 mm

SCHEMA MANIGLIA "KL" "KL" HANDLE DIAGRAM



Maniglia KL finitura titanio
passo 32 mm

Handle KL titanium finish
centre-to-centre distance 32 mm



Maniglia KL finitura titanio

Handle KL titanium finish

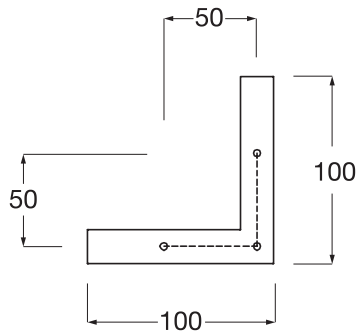
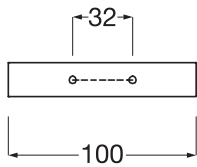

PENSILE / WALL UNIT

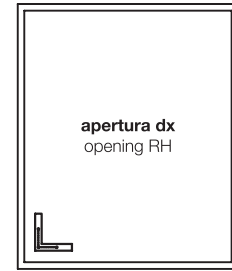
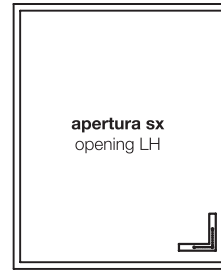

BASE / BASE UNIT

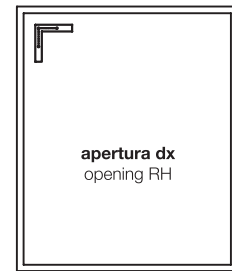

RIBALTA - APERTURA VERTICALE OBLIQUA FLAP DOOR - OBLIQUE VERTICAL OPENING

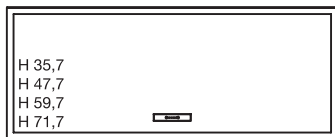

H 35,7
H 47,7
H 59,7
H 71,7

PENSILE WALL UNIT

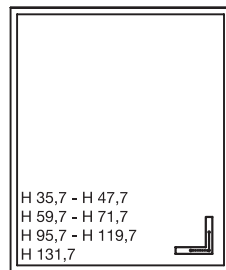

H 35,7 - H 47,7
H 59,7 - H 71,7
H 95,7 - H 119,7
H 131,7

BASE BASE UNIT

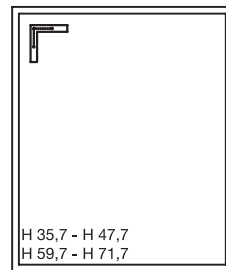

H 35,7 - H 47,7
H 59,7 - H 71,7

ANTA LAVASTOVIGLIE ANTA CESTELLO ESTRAIBILE DISHWASHER DOOR PULL-OUT BASKET DRAWER DOOR

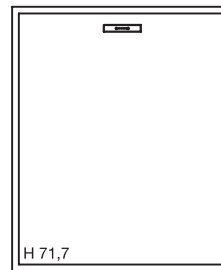

H 71,7

CASSETTO E CESTONE DRAWER AND DEEP DRAWER

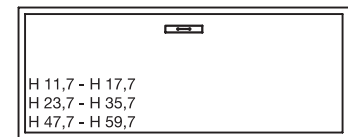

H 11,7 - H 17,7
H 23,7 - H 35,7
H 47,7 - H 59,7

COLONNA 1 ANTA COLUMN DOOR

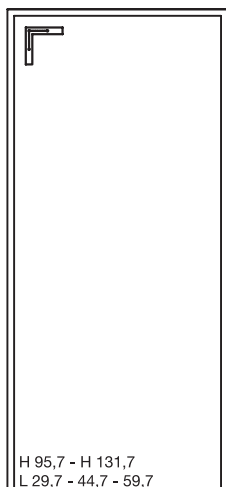

H 95,7 - H 131,7
L 29,7 - 44,7 - 59,7

COLONNA ANTA CESTELLO ESTRAIBILE COLUMN PULL-OUT BASKET DRAWER DOOR

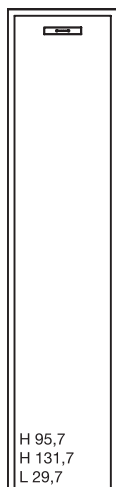

H 95,7
H 131,7
L 29,7

COLONNA MONOPORTA FRIGO - DISPENSA COLUMN SINGLE DOOR FRIDGE - CABINET

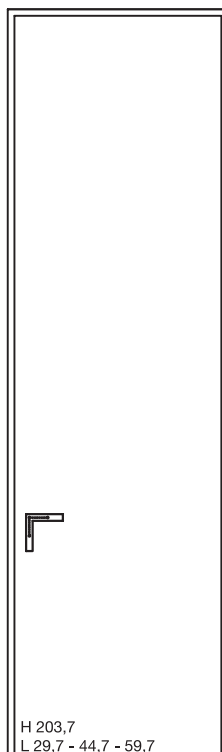

H 203,7
L 29,7 - 44,7 - 59,7

COLONNA ANTA CESTELLO ESTRAIBILE COLUMN PULL-OUT BASKET DRAWER DOOR

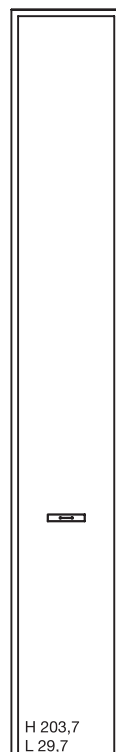

H 203,7
L 29,7

COLONNA FRIGO - DISPENSA COLUMN FRIDGE - CABINET

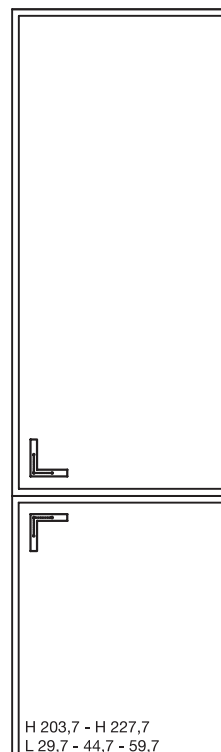

H 203,7 - H 227,7
L 29,7 - 44,7 - 59,7

COLONNA FORNO OVEN COLUMN

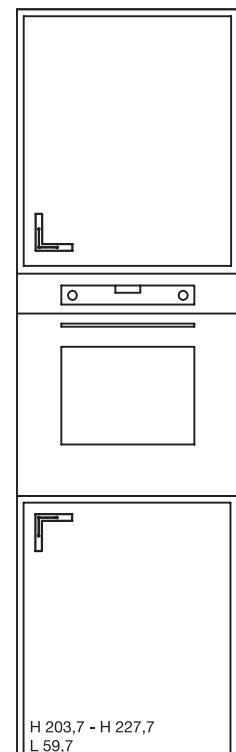

H 203,7 - H 227,7
L 59,7

strutture carcasses



bianco (opz.001)
schiena e ripiano bianco
(opz.001)
white (opt.001)
white back panel and shelf
(opt.001)



perla d'oriente (opz.940)
schiena e ripiano bianco
(opz.001)
oriental pearl (opt.940)
white back panel and shelf
(opt.001)



visone (opz.948M)
schiena e ripiano visone
(opz.948M)
mink (opt.948M)
mink back panel and shelf
(opt.948M)



devalè finitura grafis
(opz.796) schiena e ripiano
bianco (opz.001)
devalè with grafis finish
(opt.796)
white back panel and shelf
(opt.001)

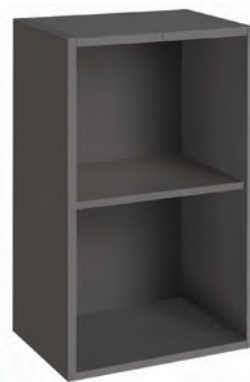

lavagna (opz.9620)
schiena e ripiano lavagna
(opz.9620)
slate grey (opt.9620)
slate grey back panel
and shelf (opt.9620)



fango (opz.8860)
schiena e ripiano fango
(opz.8860)
mud (opt.8860)
mud back panel and shelf
(opt.8860)



CREO ECOLOGIC

IL GRUPPO LUBE HA SCELTO DI UTILIZZARE PER I COMPONENTI COSTITUENTI LE STRUTTURE DELLE CUCINE SOLO MATERIALE A BASSISSIMA EMISSIONE DI FORMALDEIDE: CONFORMI ALLO STANDARD FASTELLE SECONDO LA NORMA JIS, CERTIFICATO DAL MINISTERO GIAPPONESE, IL PIU' SEVERO IN MERITO ALLE NORMATIVE DI SALVAGUARDIA AMBIENTALE.

LUBE GROUP HAS CHOSEN TO EXCLUSIVELY USE MATERIALS WITH VERY LOW FORMALDEHYDE EMISSIONS FOR THE COMPONENTS MAKING UP THE KITCHEN CARCASSES: THESE ELEMENTS COMPLY WITH THE F4 STAR STANDARD ACCORDING TO JIS, CERTIFIED BY THE JAPANESE GOVERNMENT - THE MOST STRINGENT WHEN IT COMES TO ENVIRONMENTAL PROTECTION.

mensole in nobilitato P 31-61 SP.3,8 come strutture same colours as carcasses melamine coated shelves D 31-61 Th.3,8



bianco (opz.001)
white (opt.001)



perla d'oriente (opz.940)
oriental pearl (opt.940)

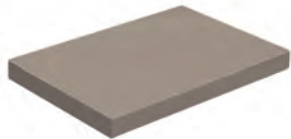

visone (opz.948M)
mink (opt.948M)

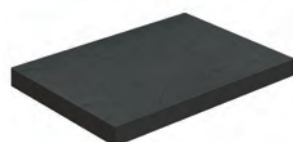

lavagna (opz.9620)
slate grey (opt.9620)

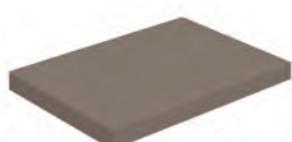

fango (opz.8860)
mud (opt.8860)



devalè finitura grafis (opz.796)
devalè with grafis finish (opt.796)

mensole laccate lacquered shelves

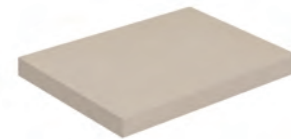

N.B.: disponibili in tutti i colori
opachi della tabella laccati
Creo Kitchens (vedi inserto allegato)

Note: available in all matt colours
on the Creo Kitchens lacquered
colour chart (see insert attached)

mensole in nobilitato P 31-61 SP.3,8 come ante melaminico laminated shelves same as melamine coated doors D 31-61 Th.3,8



frassino creta (opz.2401)
clay ash (opt.2401)



pine cipria (opz.3051)
pale pink pine (opt.3051)



noce brown (opz.2371)
brown walnut (opt.2371)



faggio naturale (opz.1569)
natural beech (opt.1569)



rovere grigio gessato
(opz.5330)
pinstripe grey oak (opt.5330)



pine polar (opz.3052)
polar pine (opt.3052)

zoccoli in pvc H 13 pvc plinths H 13

di serie
standard



acciaio (opz.407)
steel (opt.407)

zoccoli in alluminio H 13 aluminium plinths H 13

magg. rispetto allo zoccolo standard
surcharges compared to standard plinth



alluminio
finitura brill
(opz.412)
aluminium
brill finish (opt.412)



alluminio finitura titanio
ossidato (opz.414)
aluminium titanium
oxidized finish (opt.414)

al ml per lm cod.092125 +20 €
code

angolare cod.0923933 +2 €
angular code

zoccoli in alluminio H 13 verniciati a polvere finitura opaca aluminum plinth height H 13 powder coated matt finish

magg. rispetto allo zoccolo standard
surcharges compared to standard plinth



alluminio finitura
cuoio (opz.8897)
aluminium leather
finish (opt.8897)



alluminio finitura
grigio piombo
(opz.9537)
aluminium lead
grey finish (opt.9537)



alluminio finitura
nocciola (opz.7775)
aluminium hazel
finish (opt.7775)



alluminio finitura
canapa (opz.8531)
aluminium hemp
finish (opt.8531)

al ml per lm cod.092125 +35 €
code

angolare cod.0923933 +4 €
angular code



alluminio finitura
platino (opz.7773)
aluminium platinum
finish (opt.7773)



alluminio finitura
polvere (opz.9539)
aluminium dust
finish (opt.9539)



alluminio finitura
bianco assoluto
(opz.740S)
aluminium absolute
white finish (opt.740S)



alluminio finitura
bianco caldo
(opz.7401)
aluminium warm
white finish (opt.7401)



alluminio finitura
blu fiordaliso
(opz.8377)
aluminium cornflower
blue finish (opt.8377)



alluminio finitura
grigio bromo
(opz.9533)
aluminium bromine
grey finish (opt.9533)

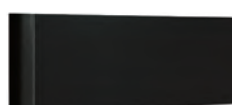

alluminio finitura
nero (opz.7892)
aluminium
black finish
(opt.7892)



alluminio finitura
terra di siena
(opz.8161)
aluminium siena
earth finish
(opt.8161)



alluminio finitura
castoro (opz.8907)
aluminium beaver
finish (opt.8907)



alluminio finitura
fumo (opz.9531)
aluminium smoke
finish (opt.9531)



alluminio finitura
giallo ambra
(opz.8225)
aluminium amber
yellow finish (opt.8225)



alluminio finitura
rosso toscano
(opz.8157)
aluminium tuscan
red finish (opt.8157)



alluminio finitura
verde positano
(opz.8471)
aluminium positano
green finish (opt.8471)

abbinamento colori consigliati
recommended colour combinations

ante melaminico
melamine doors



pine cipria (opz.3051)
pale pink pine (opt.3051)



pine polar (opz.3052)
polar pine (opt.3052)



rovere grigio gessato (opz.5330)
pinstripe grey oak (opt.5330)

ante laccate
lacquered doors



polvere opaco (opz.9539)
matt powder (opt.9539)



platino opaco (opz.7773)
matt platinum (opt.7773)



grigio piombo opaco (opz.9537)
matt lead grey (opt.9537)

elementi a giorno
open units

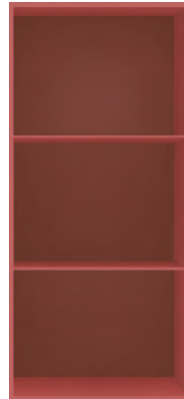

rosso toscano (opz.8157)
tuscan red (opt.8157)

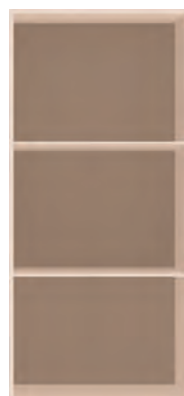

rosa quarzo (opz.8171)
quartz pink (opt.8171)

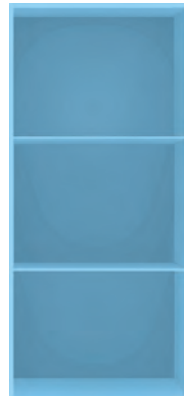

blu fiordaliso (opz.8377)
cornflower blue (opt.8377)

top
worktops

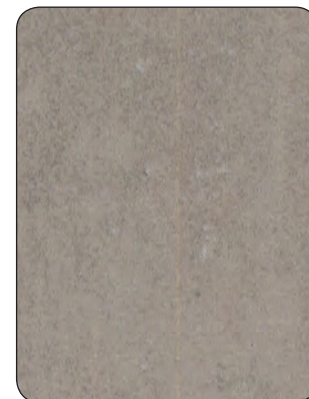

top laminato ABS1 malta visone vintage finitura plamky (opz.5568)
laminato ABS1 worktop vintage mink mortar with plamky finish (opt.5568)



top laminato ABS1 tortora finitura plamky (opz.1027)
laminato ABS1 worktop dove grey with plamky finish (opt.1027)



top laminato ABS1 bianco finitura velvet (opz.800)
laminato ABS1 worktop white with velvet finish (opt.800)

abbinamento colori consigliati
recommended colour combinations

ante melaminico
melamine doors



frassino creta (opz.2401)
clay ash (opt.2401)



faggio naturale (opz.1569)
natural beech (opt.1569)



noce brown (opz.2371)
brown walnut (opt.2371)

ante laccate
lacquered doors



cuoio opaco (opz.8897)
matt leather (opt.8897)



nocciola opaco (opz.7775)
matt hazel (opt.7775)



canapa opaco (opz.8531)
matt hemp (opt.8531)

elementi a giorno
open units



rosso toscano (opz.8157)
tuscan red (opt.8157)

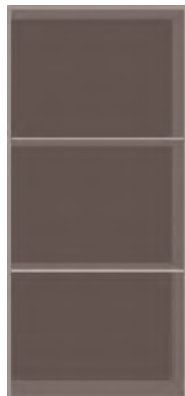

cuoio (opz.8897)
leather (opt.8897)



giallo ambra (opz.8225)
amber yellow (opt.8225)

top
worktops



**top laminato ABS1 peltro
finitura ossidata (opz.L934)**
lamine ABS1 worktop
pewter with oxidized finish
(opt.L934)

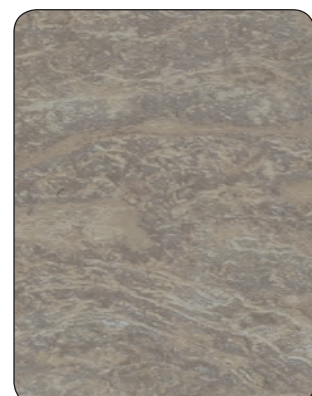

**top laminato ABS1 grigio
cemento finitura touch
(opz.786)**
lamine ABS1 worktop
cement grey touch finish
(opt.786)

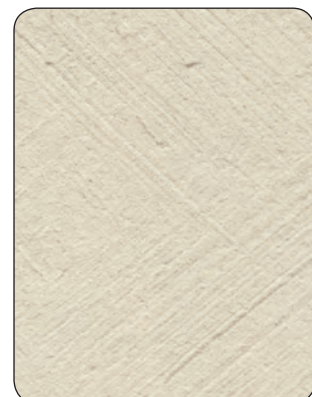

**top laminato ABS1 calce
finitura wraky (opz.814)**
lamine ABS1 worktop
whitewash with wraky finish
(opt.814)

MODULARITÀ E COMPONENTIBILITÀ MODULARITY AND FITTING SOLUTIONS

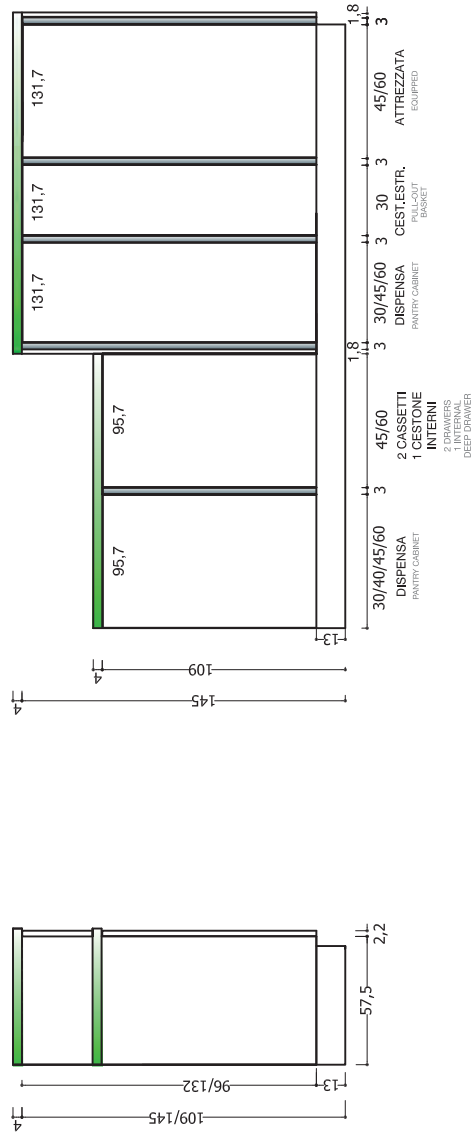

COLONNE COLUMNS

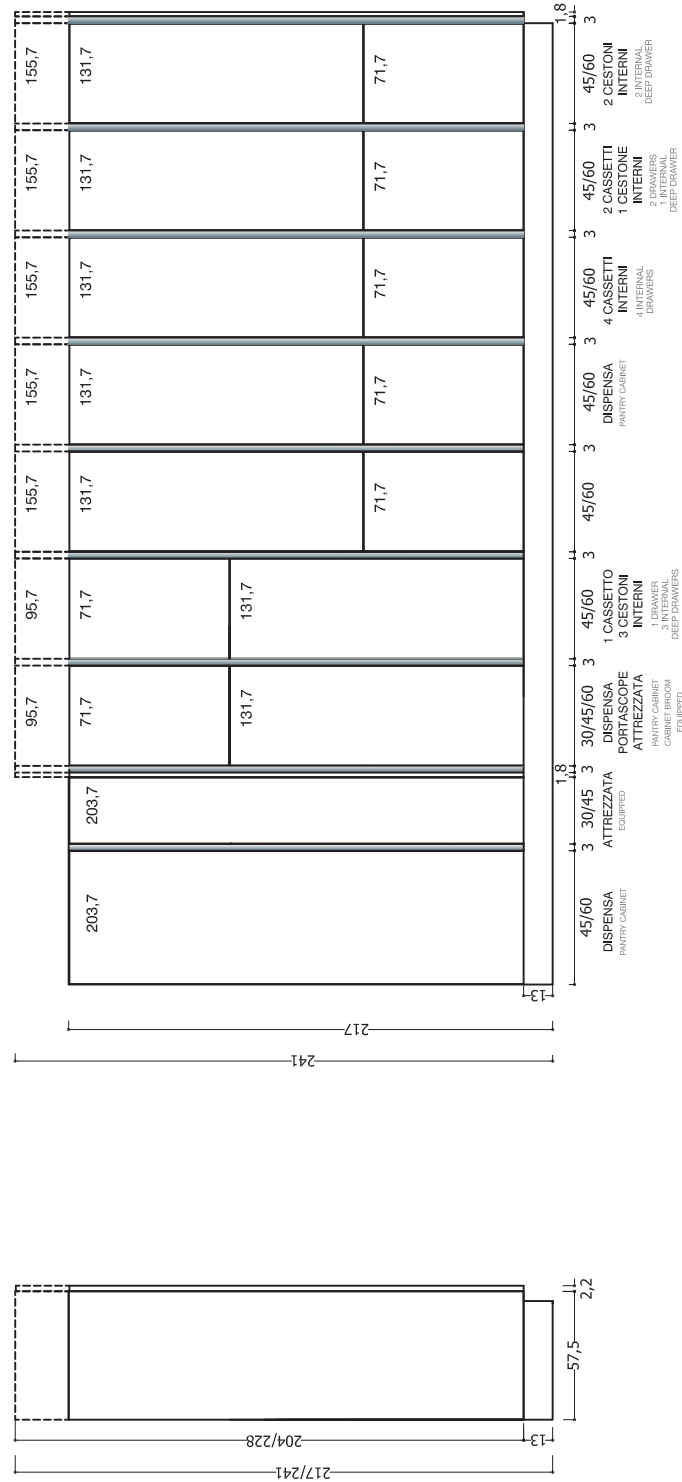



MODULARITÀ E COMPONIBILITÀ MODULARITY AND FITTING SOLUTIONS

COLONNE FRIGO
FRIDGE COLUMNS

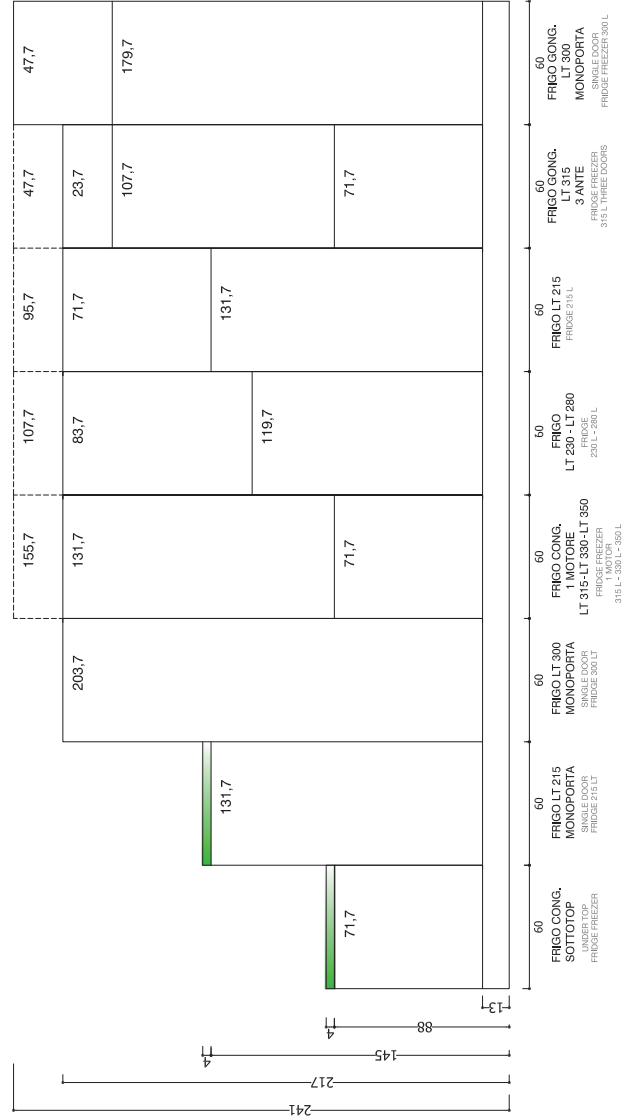
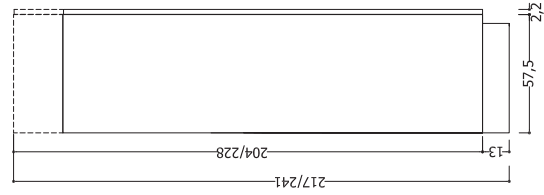



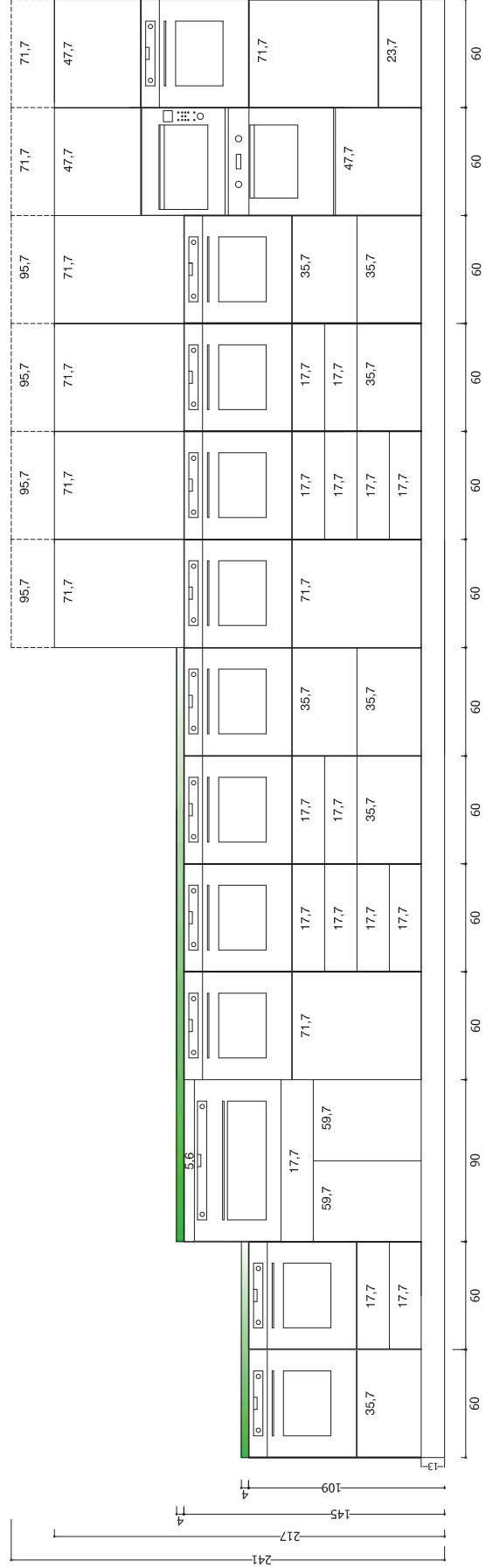
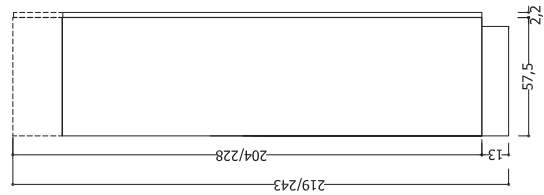



COLONNE FORNO
OVEN COLUMNS













N.B.: cerniere ammortizzate di serie
Note: standard blumotion hinges

		COD.	MELAMI- NICO K36	LACCATO OPACO K37	DECORO K39			
 <p>1 anta H 36 1 door H 36</p>	L 45	G2030451/2	140	152	236			
	L 60	G2030601/2	153	160	268			
	L 65	G2030651/2	158	167	—			
 <p>1 anta H 48 1 door H 48</p>	L 45	G2040451/2	154	160	277			
	L 60	G2040601/2	172	178	379			
	L 65	G2040651/2	178	185	—			
 <p>1 anta H 60 1 door H 60</p>	L 45	G2060451/2	169	172	—			
	L 60	G2060601/2	185	194	408			
 <p>1 anta H 72 1 door H 72</p>	L 15	G2010151/2	143	132	—			
	L 30	G2010301/2	160	157	—			
	L 40	G2010401/2	170	174	—			
	L 45	G2010451/2	175	181	—			
	L 60	G2010601/2	192	206	—			
	L 65	G2010651/2	203	234	—			
 <p>1 anta H 96 1 door H 96</p>	L 15	G2020151/2	165	158	—			
	L 30	G2020301/2	190	183	—			
	L 40	G2020401/2	204	207	—			
	L 45	G2020451/2	212	216	—			
	L 60	G2020601/2	239	257	—			
	L 65	G2020651/2	246	273	—			
 <p>1 anta H 120 1 door H 120</p>	L 30	G2145301/2	264	261	—			
	L 45	G2145451/2	286	296	—			
	L 60	G2145601/2	323	350	—			
 <p>1 anta H 132 1 door H 132</p>	L 30	G2141301/2	273	264	—			
	L 45	G2141451/2	305	314	—			

N.B.: cerniere ammortizzate di serie Note: standard blumotion hinges		COD.	MELAMI- NICO	LACCATO OPACO	DECORO			
			K36	K37	K39			
 <p>2 ante H 36 2 doors H 36</p>	L 90	G2030900	241	266	439			
		G2040900	264	276	514			
 <p>2 ante H 48 2 doors H 48</p>	L 90	G2060900	289	295	—			
		G2010600	272	266	—			
 <p>2 ante H 72 2 doors H 72</p>	L 60	G2010800	293	302	—			
	L 80	G2010900	303	314	—			
	L 90	G2020600	323	310	—			
 <p>2 ante H 96 2 doors H 96</p>	L 60	G2020800	351	358	—			
	L 80	G2020900	368	375	—			
	L 90							
 <p>cestello estraibile chiusura soft pull-out basket unit soft-closing system</p>	H 72 L 15	G2010150	181	169	—			
	H 96 L 15	G2020150	216	209	—			
 <p>fascia tamponamento L da 3 a 10 N.B.: da L 3 a 5 è realizzata in massello liscio, superiore a L 5 è realizzata con cornice come anta filler panel size from 3 to 10 Note: realized in smooth solid wood from W 3 to 5, up to W 5 realized with frame as door</p>	H 60	G2790000	131	140	—			
	H 72	G2800000	131	140	—			
	H 96	G2810000	147	179	—			
 <p>Apertura senza maniglia, presa sul fondo Grip on bottom opening, without handle</p> <p>Anta Door Fondo pensile Wall unit bottom</p>								

N.B.: cerniere ammortizzate di serie Note: standard blumotion hinges		COD.	MELAMI- NICO	LACCATO OPACO	DECORO			
			K36	K37	K39			
 <p>angolo H 72 1 anta diagonale corner unit H 72 1 diagonal door</p>	65X65	G2400651/2	246	251	—			
		 <p>angolo H 96 1 anta diagonale corner unit H 96 1 diagonal door</p>	65X65	G2410651/2	294	298	—	
 <p>angolo H 72 2 ante a libretto N.B.: fuori squadra realizzabili da 88° a 92° corner unit H 72 2 folding doors Note: out-of-plumb units available from 88° to 92°</p>	65X65			G2450651/2	347	362	—	
		 <p>angolo H 96 2 ante a libretto N.B.: fuori squadra realizzabili da 88° a 92° corner unit H 96 2 folding doors Note: out-of-plumb units available from 88° to 92°</p>	65X65	G2460651/2	427	422	—	
 <p>copriboiler H 72 1 anta boiler housing H 72 1 door</p>	L 60 P 33,4 L 60 P 47,4 L 60 P 59,9			G2150601/2	186	200	—	
		G2160601/2	235	250	—			
		G2170601/2	235	250	—			
 <p>copriboiler H 96 1 anta boiler housing H 96 1 door</p>	L 60 P 33,4 L 60 P 47,4 L 60 P 59,9	G2210601/2	220	240	—			
		G2220601/2	281	304	—			
		G2230601/2	281	304	—			
 <p>jolly pensile H 72 L da 10 a 30 jolly wall unit H 72 size from 10 to 30</p>	colore come struttura same colour as carcass melaminico come anta melamine same as door laccato come anta lacquered same as door	G2700000	53	53	—			
		G2700030	160	—	—			
		G2740000	—	321	—			
 <p>jolly pensile H 96 L da 10 a 30 jolly wall unit H 96 size from 10 to 30</p>	colore come struttura same colour as carcass melaminico come anta melamine same as door laccato come anta lacquered same as door	G2710000	61	61	—			
		G2710030	199	—	—			
		G2750000	—	408	—			

PENSILE CON APERTURA A RIBALTA

Le ante aprendosi verso l'alto consentono di avere un' ampia visione d'insieme all'interno del mobile. In questo modo è possibile un comodo accesso agli oggetti contenuti al suo interno e, dal punto di vista ergonomico, molto vantaggioso. La regolazione della forza di apertura può essere impostata in modo esatto in base al peso del frontale. Grazie all'arresto progressivo le ante si fermano in qualsiasi posizione; in questo modo la maniglia è sempre facilmente raggiungibile. La chiusura è ammortizzata di serie.

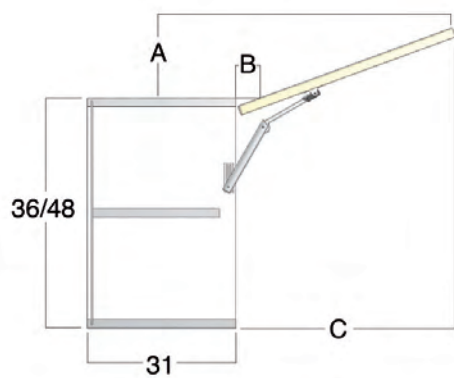

WALL UNIT WITH FLAP DOOR

The doors that open upwards guarantee ample overall visibility inside the cabinet. In this way, all objects housed inside the cabinet can be comfortably accessed, making the system highly advantageous from an ergonomic perspective. The opening force can be adjusted precisely according to the weight of the front. The doors stop in any position thanks to the gradual stopping movement; in this way, the handle is always easily accessible. The closing movement is cushioned standard



	A	B	C
H 36	7	4	37
H 48	11	4	49

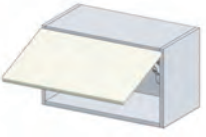

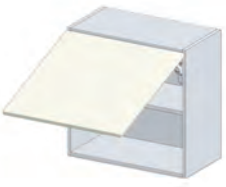
N.B.: sovrapponibili solo con le ribalte tip-on
 Note: overlapping only with tip-on flap doors

	COD.	MELAMI- NICO K36	LACCATO OPACO K37	DECORO K39			
anta ribalta H 36 flap door H 36 	L 45	G2100450	165	177	264		
	L 60	G2100600	173	180	287		
	L 65	G2100650	185	194	—		
	L 90	G2100900	215	214	406		
anta ribalta H 48 flap door H 48 	L 45	G2120450	180	186	306		
	L 60	G2120600	204	211	411		
	L 65	G2120650	217	225	—		
	L 90	G2120900	243	249	554		
anta ribalta H 60 flap door H 60 	L 60	G212560C	249	258	473		
	L 90	G212590C	314	329	—		

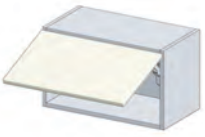

Grazie al meccanismo TIP-ON, le ante a ribalta senza maniglia possono essere aperte semplicemente con un leggero tocco. Per chiudere l'anta a ribalta, è sufficiente esercitare una leggera pressione, che grazie ad una piastrina di bloccaggio, applicata sul lato interno del frontale, ne assicura la perfetta chiusura.

Thanks to TIP-ON mechanism, the flap doors without handles can be opened with a simple touch. To close the flap door, just exercise light pressure, thanks to the locking plate, applied on the inner side of the front panel ensures a perfect closure.

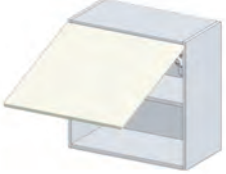
		COD.	MELAMINICO K36	LACCATO OPACO K37	DECORO K39			
 <p>anta ribalta TIP-ON H 36 flap door TIP-ON H 36</p>	L 45	G210046T	165	177	271			
	L 60	G210061T	173	179	293			
	L 65	G210066T	185	194	—			
	L 90	G210091T	215	214	409			
 <p>anta ribalta TIP-ON H 48 flap door TIP-ON H 48</p>	L 45	G212046T	176	182	312			
	L 60	G212061T	202	208	418			
	L 65	G212066T	215	223	—			
	L 90	G212091T	241	247	558			
 <p>anta ribalta TIP-ON H 60 flap door TIP-ON H 60</p>	L 60	G212561T	250	259	480			
	L 90	G212591T	316	329	—			

APERTURA VERTICALE OBLIQUA

I pensili con questo tipo di meccanismo necessitano per l'apertura di poco spazio libero sopra il mobile grazie al movimento basculante dell'anta che si apre senza difficoltà applicando poca forza anche in presenza di frontali pesanti. Con l'arresto progressivo le ante si fermano in qualsiasi posizione; in questo modo la maniglia è sempre facilmente raggiungibile. La chiusura è ammortizzata ed è possibile regolare la forza di tenuta in base al peso del frontale.

VERTICAL OPENING OBLIQUE

Wall units that mount this type of mechanism require little clearance above the cabinet thanks to the swivelling movement of the door that can be easily opened by applying slight pressure, even with heavy fronts. The doors stop in any position thanks to the gradual stopping movement; in this way, the handle is always easily accessible. The closing movement is cushioned and the closing force can be adjusted according to the weight of the front door.

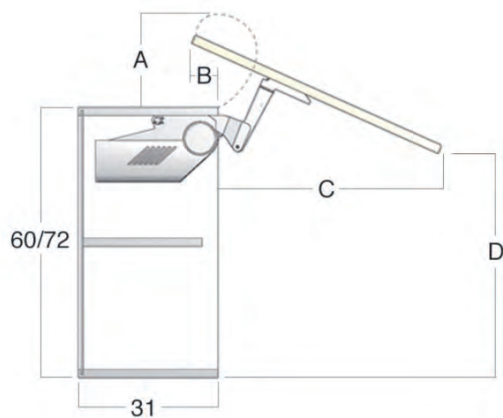

	A	B	C	D
H 60	18	9,6	46,5	53,5
H 72	18	9,6	57	61

PENSILE CON APERTURA ANTE A PACCHETTO

Il meccanismo d'apertura ante a pacchetto è idoneo sia sul pensile H 72 che H 96; la regolazione della forza di apertura può essere impostata in modo esatto in base ai pesi dei frontali, la chiusura è ammortizzata e la cerniera centrale clip si contraddistingue per l'innovativa tecnologia che garantisce la sicurezza per le dita.

WALL UNIT WITH LIFT-UP FOLDING DOORS

The lift-up folding door opening mechanism is suitable for wall units with H 72 or H 96; the opening force can be adjusted precisely according to the weight of the fronts, while the closing movement is cushioned and the central clip-on hinge features innovative technology for safeguarding the fingers.



H 72



H 96

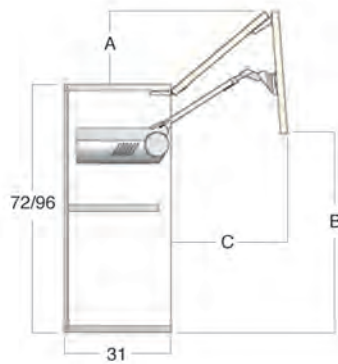

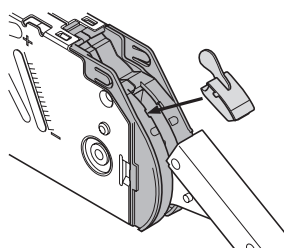
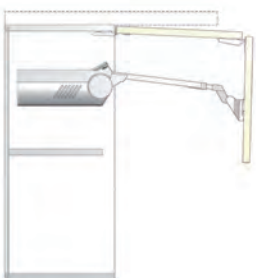

	A	B	C
H 72	16,5	54	41
H 96	20	69	53

**SCHEMA MONTAGGIO
LIMITATORE
LIMITER INSTALLATION
DIAGRAM**

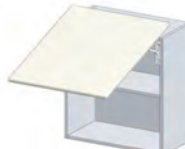
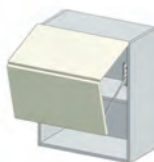

Per evitare l'interferenza dell'anta in fase di apertura con cornici o mensole, si può richiedere il limitatore dell'angolo di apertura cod. 5620005 € 10

In order to avoid that the door interferes with cornices or shelves during the opening movement, it is possible to request an opening angle limiter: code 5620005 € 10





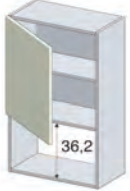

	COD.	MELAMI- NICO K36	LACCATO OPACO K37	DECORO K39			
<p>anta apertura verticale obliqua H 60 door with oblique vertical opening H 60</p> 	L 60	G2135600	290	300	514		
	L 90	G2135900	338	353	—		
<p>anta apertura verticale obliqua H 72 door with oblique vertical opening H 72</p> 	L 60	G2130600	303	317	—		
	L 90	G2130900	350	376	—		
<p>pensile H 72 apertura a pacchetto 2 ante H 36 wall unit H 72 lift-up folding door 2 doors H 36</p> 	L 45	G2070450	351	376	—		
	L 60	G2070600	376	390	—		
	L 65	G2070650	383	400	—		
	L 90	G2070900	434	432	—		
<p>pensile H 96 apertura a pacchetto 2 ante H 48 wall unit H 96 lift-up folding door 2 doors H 48</p> 	L 45	G2090450	380	392	—		
	L 60	G2090600	411	425	—		
	L 65	G2090650	419	435	—		
	L 90	G2090900	486	498	—		

N.B.: cerniere ammortizzate di serie





Note: standard blumotion hinges





	COD.	MELAMI- NICO K36	LACCATO OPACO K37	DECORO K39			
<p>pensile H 72 1 anta ribalta H 36 apertura TIP-ON vano per micro Whirlpool wall unit H 72 1 flap door H 36 TIP-ON opening housing for Whirlpool microwave</p> 							
	L 60 GPM20600	186	190	—			
<p>pensile H 96 1 anta H 60 apertura push-pull vano per micro Whirlpool wall unit H 96 1 door H 60 push-pull opening housing for Whirlpool microwave</p> 							
	L 60 GPM25601/2	217	227	—			



N.B.: cerniere ammortizzate di serie
 Note: standard blumotion hinges



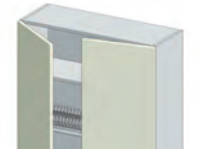

		COD.	MELAMI- NICO K36	LACCATO OPACO K37	DECORO K39			
 <p>soprapensile H 36 1 anta top unit H 36 1 door</p>	L 45	G2063451/2	192	206	—			
	L 60	G2063601/2	194	212	—			
 <p>soprapensile H 48 1 anta top unit H 48 1 door</p>	L 45	G2064451/2	228	236	—			
	L 60	G2064601/2	236	243	—			
 <p>soprapensile H 60 1 anta top unit H 60 1 door</p>	L 45	G2065451/2	237	242	—			
	L 60	G2065601/2	243	254	—			
 <p>soprapensile H 36 2 ante top unit H 36 2 doors</p>	L 90	G2063900	296	322	—			
 <p>soprapensile H 48 2 ante top unit H 48 2 doors</p>	L 90	G2064900	344	357	—			
 <p>soprapensile H 60 2 ante top unit H 60 2 doors</p>	L 90	G2065900	363	370	—			

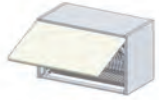
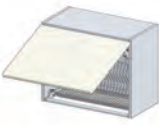
N.B.: cerniere ammortizzate di serie
 Note: standard blumotion hinges

	COD.	MELAMI- NICO K36	LACCATO OPACO K37	DECORO K39			
1 anta H 60 1 door H 60 	L 60 G3060601/2	194	204	417			
		+84	+84	+84			
1 anta H 72 1 door H 72 	L 45 G3010451/2	186	191	—			
	L 60 G3010601/2	201	215	—			
	L 65 G3010651/2	235	266	—			
		+84	+84	—			
1 anta H 96 1 door H 96 	L 45 G3020451/2	223	226	—			
	L 60 G3020601/2	252	271	—			
	L 65 G3020651/2	278	304	—			
		+84	+84	—			
1 anta H 120 1 door H 120 	L 45 G3067451/2	291	301	—			
	L 60 G3067601/2	323	351	—			
		+84	+84	—			



N.B.: cerniere ammortizzate di serie Note: standard blumotion hinges		COD.	MELAMI- NICO K36	LACCATO OPACO K37	DECORO K39			
	2 ante H 60 2 doors H 60	L 90	G3060900	308	314	—		
	mag.griglie con luce led surcharge grilles with led light			+84	+84	—		
		2 ante H 72 2 doors H 72	L 80	G3010800	312	321	—	
L 90		G3010900	324	334	—			
mag.griglie con luce led surcharge grilles with led light				+84	+84	—		
	2 ante H 96 2 doors H 96	L 80	G3020800	368	376	—		
	L 90	G3020900	387	394	—			
	mag.griglie con luce led surcharge grilles with led light			+84	+84	—		
	angolo H 72 2 ante a libretto N.B.: non si effettuano fuori squadra corner unit H 72 2 folding doors Note: out-of-plumb units unavailable	65X65	G3450651/2	487	510	—		
		angolo H 96 2 ante a libretto N.B.: non si effettuano fuori squadra corner unit H 96 2 folding doors Note: out-of-plumb units unavailable	65X65	G3460651/2	573	568	—	

	COD.	MELAMINICO K36	LACCATO OPACO K37	DECORO K39				
<p>anta ribalta H 36 flap door H 36</p> 	L 60 G3100600	178	191	291				
	L 90 G3100900	225	225	413				
	mag.griglie con luce led surcharge grilles with led light		+84	+84	+84			
<p>anta ribalta H 48 flap door H 48</p> 	L 60 G3120600	199	206	405				
	L 90 G3120900	241	247	549				
	mag.griglie con luce led surcharge grilles with led light		+84	+84	+84			
<p>anta ribalta H 60 flap door H 60</p> 	L 60 G312260C	249	259	471				
	L 90 G312290C	318	333	—				
	mag.griglie con luce led surcharge grilles with led light		+84	+84	+84			

		COD.	MELAMI- NICO K36	LACCATO OPACO K37	DECORO K39				
 <p>anta apertura verticale obliqua H 60 door with vertical oblique opening H 60</p>	L 60	G3123600	292	302	519				
	L 90	G3123900	343	358	—				
				+84	+84	+84			
			mag.griglie con luce led surcharge grilles with led light						
 <p>anta apertura verticale obliqua H 72 door with vertical oblique opening H 72</p>	L 60	G3125600	304	318	—				
	L 90	G3125900	353	380	—				
				+84	+84	—			
			mag.griglie con luce led surcharge grilles with led light						
 <p>scolapiatti H 72 apertura a pacchetto 2 ante H 36 plate rack unit H 72 lift-up folding door 2 doors H 36</p>	L 60	G3081600	377	394	—				
	L 90	G3081900	438	436	—				
				+84	+84	—			
			mag.griglie con luce led surcharge grilles with led light						
 <p>scolapiatti H 96 apertura a pacchetto 2 ante H 48 plate rack unit H 96 lift-up folding door 2 doors H 48</p>	L 60	G3094600	413	426	—				
	L 90	G3094900	490	502	—				
				+84	+84	—			
			mag.griglie con luce led surcharge grilles with led light						

N.B.: cerniere ammortizzate di serie

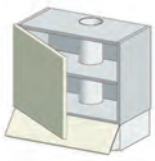
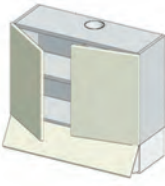
Note: standard blumotion hinges

		COD.	MELAMINICO K36	LACCATO OPACO K37	DECORO K39			
 <p>cappa estraibile 2 motori portata 275 m³/h con laterali in metallo, 1 anta apertura push-pull N.B.: posizionare la cappa ad una distanza non inferiore ai 65 cm dal piano cottura</p> <p>slide-out hood 2 motors air flow rate 275 m³/h with metal sides, 1 door push-pull opening Note: position the hood at least 65 cm from the cooker hob</p>	H 63 L 60	G3600601/2	324	348	—			
	H 87 L 60	G3610601/2	347	378	—			
	n° 2 filtri carbone attivo 2 active carbon filters		+24	+24	—			
 <p>cappa estraibile 2 motori portata 275 m³/h con laterali in metallo, 2 ante apertura push-pull N.B.: posizionare la cappa ad una distanza non inferiore ai 65 cm dal piano cottura</p> <p>slide-out hood 2 motors air flow rate 275 m³/h with metal sides, 2 doors push-pull opening Note: position the hood at least 65 cm from the cooker hob</p>	H 63 L 90	G3600900	438	466	—			
	H 87 L 90	G3610900	480	506	—			
	n° 2 filtri carbone attivo 2 active carbon filters		+24	+24	—			
 <p>cappa "Mod. F" integrata totale con frontalino vetro estraibile portata 415 m³/h con faretti a led 1 anta N.B.: posizionare la cappa ad una distanza non inferiore ai 55 cm dal piano cottura</p> <p>"Mod. F" fully integrated hood with glass pull-out frontal panel air flow rate 415 m³/h, with led lights 1 door Note: position the hood at least 55 cm from the cooker hob</p>	H 60 L 60	GPC90461/2	529	536	751			
	H 72 L 60	GPC90561/2	540	551	—			
	H 96 L 60	GPC90661/2	585	602	—			
	n° 2 filtri carbone attivo 2 active carbon filters	08750894	+28	+28	+28			
 <p>cappa "Mod. F" integrata totale con frontalino vetro estraibile portata 415 m³/h con faretti a led 2 ante N.B.: posizionare la cappa ad una distanza non inferiore ai 55 cm dal piano cottura</p> <p>"Mod. F" fully integrated hood with glass pull-out front panel air flow rate 415 m³/h with led lights 2 doors Note: position the hood at least 55 cm from the cooker hob</p>	H 60 L 90	GPC90490	658	662	—			
	H 72 L 90	GPC90590	676	684	—			
	H 96 L 90	GPC90690	738	743	—			
	n° 2 filtri carbone attivo 2 active carbon filters	08750894	+28	+28	—			

N.B.: cerniere ammortizzate di serie

Note: standard blumotion hinges

cappa "Mod. F" integrata totale con frontalino vetro estraibile portata 415 m³/h con faretti a led 1 anta apertura a ribalta

N.B.: posizionare la cappa ad una distanza non inferiore ai 55 cm dal piano cottura

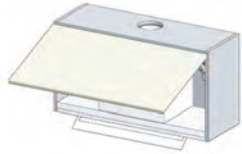

"Mod. F" fully integrated hood with glass pull-out front panel
air flow rate 415 m³/h with led lights
1 flap door

Note: position the hood at least 55 cm from the cooker hob

H 36 L 60

GPC80260

524

528

636

H 36 L 90

GPC80290

590

588

771

H 48 L 60

GPC80360

560

555

775

H 48 L 90

GPC80390

628

631

938

H 60 L 60

GPC80460

676

687

819

H 60 L 90

GPC80490

777

792

—

n° 2 filtri carbone attivo
2 active carbon filters

08750894

+28

+28

+28

cappa "Mod. F" integrata totale con frontalino vetro estraibile portata 415 m³/h con faretti a led 2 ante apertura a pacchetto

N.B.: posizionare la cappa ad una distanza non inferiore ai 55 cm dal piano cottura

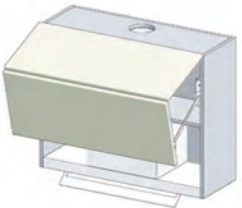

"Mod. F" fully integrated hood with glass pull-out front panel
air flow rate 415 m³/h with led lights
2 lift-up folding doors

Note: position the hood at least 55 cm from the cooker hob

H 72 L 60

GPC83560

717

729

—

H 72 L 90

GPC83590

799

796

—

H 96 L 60

GPC83660

756

766

—

H 96 L 90

GPC83690

854

864

—

n° 2 filtri carbone attivo
2 active carbon filters

08750894

+28

+28

—

cappa "Mod. F" integrata totale con frontalino vetro estraibile portata 450 m³/h 1 anta apertura verticale obliqua

N.B.: posizionare la cappa ad una distanza non inferiore ai 55 cm dal piano cottura

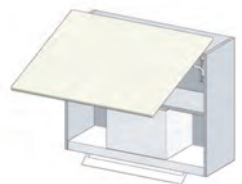

"Mod. F" fully-integrated hood with glass pull-out front panel
flow rate 415 m³/h with led lights
1 door with vertical oblique opening

Note: position the hood at least 55 cm from the cooker hob

H 60 L 60

GPC86460

642

650

865

H 60 L 90

GPC86490

715

728

—

H 72 L 60

GPC86560

658

670

—

H 72 L 90

GPC86590

729

753

—

n° 2 filtri carbone attivo
2 active carbon filters

08750894

+28

+28

+28

Maggiorazione cappa "ILMA" incasso pensile consigliata per piano cottura ad induzione

Surcharge

"ILMA" built in hood
recommended for induction cooker hob

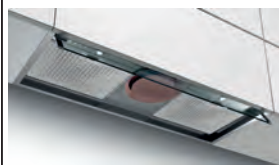

L 60

opz.003

+691

+691

+691

L 90

opz.003

+720

+720

+720

filtro carbone attivo
active carbon filter







08750889



+71

+71

+71

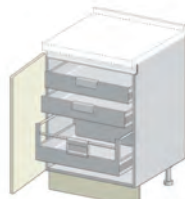
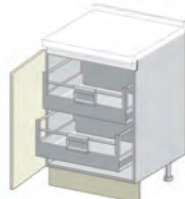
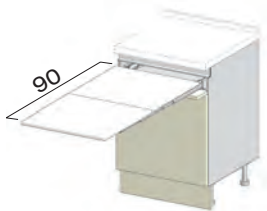
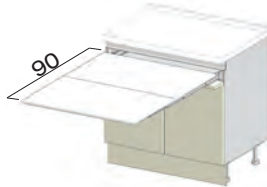

Le basi non sono comprensive di top - N.B.: cerniere ammortizzate di serie The base units do not include the tops - Note: standard blumotion hinges		COD.	MELAMINICO K36	LACCATO OPACO K37				
 <p>fascia tamponamento N.B.: da L 3 a 5 è realizzata in massello liscio, superiore a L 5 è realizzata con cornice come anta filler panel Note: realized in smooth solid wood from W 3 to 5, up to W 5 realized with frame as door</p>	L da 3 a 10 size from 3 to 10	G4800000	115	132				
 <p>jolly base L da 10 a 30 jolly base unit size from 10 to 30</p>		G4700000	94	75				
	colore come struttura same colour as carcass	G4700030	200	—				
	melaminico come anta melamine same as door	G4720000	—	390				
	laccato come anta lacquered same as door							
 <p>1 anta 1 door</p>	L 15	G4010151/2	165	154				
	L 30	G4010301/2	181	178				
	L 40	G4010401/2	194	199				
	L 45	G4010451/2	205	211				
	L 60	G4010601/2	229	243				
	L 65	G4010651/2	245	276				
 <p>2 ante 2 doors</p>	L 60	G4010600	303	297				
	L 80	G4010800	333	342				
	L 90	G4010900	350	361				
 <p>cestello estraibile chiusura soft pull-out basket unit soft-closing system</p>	L 15	G4150150	193	181				
	L 30	G4150300	247	244				
	L 45	G4150450	273	278				
 <p>4 cassetti H 16,9 4 drawers H 16,9</p>	L 30	G4100300	467	467				
	L 40	G4100400	530	480				
	L 45	G4100450	515	505				
	L 60	G4100600	594	550				
 <p>2 cassetti H 16,9 1 cestone H 34,2 2 drawers H 16,9 1 deep drawer H 34,2</p>	L 45	G4130450	434	443				
	L 60	G4130600	493	473				
	L 90	G4130900	599	571				

Le basi non sono comprensive di top - N.B.: cassetti e cestoni ad estrazione totale con blumotion The base units do not include the tops - Note: fully extending drawers and deep drawers with blumotion system		COD.	MELAMINICO K36	LACCATO OPACO K37					
 <p>4 cassetti H 16,9 1 cestone H 34,2 4 drawers H 16,9 1 deep drawer H 34,2</p>	L 90	G4300900	775	768					
	<p>portaposate in plastica per cassetti plastic cutlery tray for drawers</p> 	L 30	08700030X	10	10				
	L 40	08700040X	10	10					
	L 45	08700050X	10	10					
	L 60	08700060X	11	11					
	L 90	08700070X	32	32					
			divisori regolabili L 90 adjustable separatories						
 <p>2 cestoni H 34,2 2 deep drawers H 34,2</p>	L 45	G4170450	363	391					
	L 60	G4170600	409	412					
	L 90	G4170900	501	496					
 <p>1 anta 2 cassetti interni 1 cestone interno posizionare a 5 cm dalla parete laterale 1 door 2 internal drawers 1 internal deep drawer place at 5 cm from the side wall</p>	L 45	G4210461/2	414	416					
	L 60	G4210611/2	450	460					
 <p>1 anta 2 cestoni interni posizionare a 5 cm dalla parete laterale 1 door 2 internal deep drawers place at 5 cm from the side wall</p>	L 45	G4210471/2	362	364					
	L 60	G4210621/2	395	406					
 <p>base tavolo estraibile LUNCH portata 60 kg 1 anta H 54,5 apertura push-pull 1 frontale H 16,9 base unit with pull-out table LUNCH load capacity kg 60 1 door H 54,5 push-pull opening 1 front H 16,9</p>	L 60	G4230601/2	747	739					
	L 90	G4230900	861	841					
 <p>base tavolo estraibile LUNCH portata 60 kg 2 ante H 54,5 apertura push-pull 1 frontale H 16,9 base unit with pull-out table LUNCH load capacity kg 60 2 doors H 54,5 push-pull opening 1 front H 16,9</p>	L 90	G4230900	861	841					

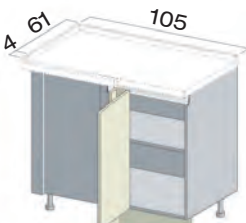
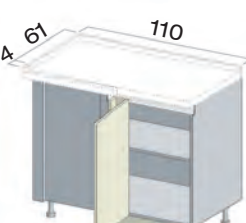
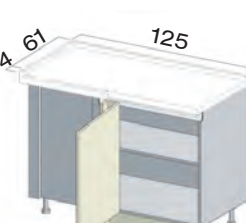
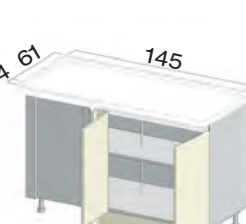
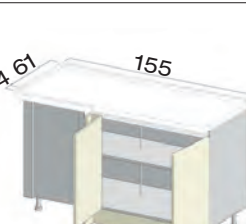
Le basi non sono comprensive di top - N.B.: cerniere ammortizzate di serie The base units do not include the tops - Note: standard blumotion hinges		COD.	MELAMI- NICO K36	LACCATO OPACO K37				
 <p>angolo L 95 1 ripiano 1 anta L 30 (cerniere a pilastro) cassone 90 corner unit W 95 1 shelf 1 door W 30 (pillar hinges) structure 90</p> <p>verso dx RH version</p>	95x65	G4400951/2	403	415				
 <p>angolo L 105 1 ripiano 1 anta L 40 (cerniere a pilastro) cassone 90 corner unit W 105 1 shelf 1 door W 40 (pillar hinges) structure 90</p> <p>verso dx RH version</p>	105x65	G4401041/2	413	432				
 <p>angolo L 110 1 ripiano 1 anta L 45 (cerniere a pilastro) cassone 105 corner unit W 110 1 shelf 1 door W 45 (pillar hinges) structure 105</p> <p>verso dx RH version</p>	110x65	G4401091/2	433	453				
 <p>angolo L 125 1 ripiano 1 anta L 60 (cerniere a pilastro) cassone 120 corner unit W 125 1 shelf 1 door W 60 (pillar hinges) structure 120</p> <p>verso dx RH version</p>	125x65	G4401241/2	456	484				
 <p>angolo L 145 1 ripiano 2 ante L 40 (cerniere a pilastro) cassone 140 con tirante corner unit W 145 1 shelf 2 doors W 40 (pillar hinges) structure 140 with tie beam</p> <p>verso dx RH version</p>	145x65	G4401451/2	558	582				
 <p>angolo L 155 1 ripiano 2 ante L 45 (cerniere a pilastro) cassone 150 con tirante corner unit W 155 1 shelf 2 doors W 45 (pillar hinges) structure 150 with tie beam</p> <p>verso dx RH version</p>	155x65	G4401551/2	570	596				

BASI ANGOLO

CORNER BASE UNITS

H 88 P 65



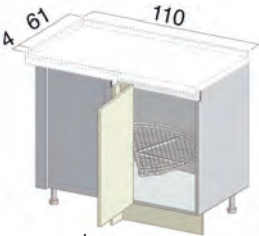
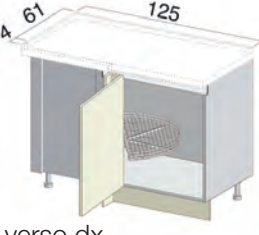
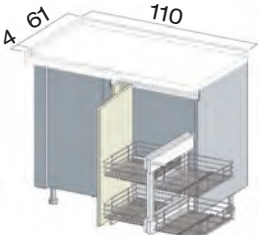
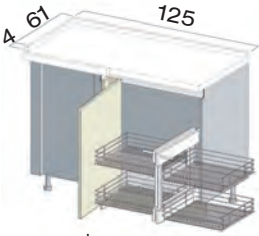
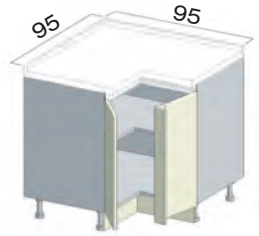
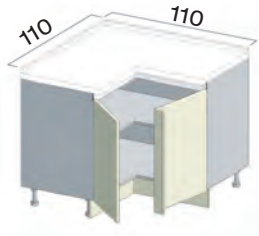

Le basi non sono comprensive di top - N.B.: cerniere ammortizzate di serie
 The base units do not include the tops - Note: standard blumotion hinges

	COD.	MELAMI- NICO K36	LACCATO OPACO K37				
 <p>angolo L 110 cestello mezzaluna 1 anta L 45 (cerniere a pilastro) cassone 105 corner unit W 110 crescent-shaped wire basket unit 1 door W 45 (pillar hinges) structure 105</p> <p>verso dx RH version</p>							
	<p>1 cestello 110x65 1 basket drawer</p> <p>2 cestelli 110x65 2 basket drawers</p>	G4401101/2	433	453			
 <p>angolo L 125 cestello mezzaluna 1 anta L 60 (cerniere a pilastro) cassone 120 corner unit W 125 crescent-shaped wire basket units 1 door W 60 (pillar hinges) structure 120</p> <p>verso dx RH version</p>							
	<p>1 cestello 125x65 1 basket drawer</p> <p>2 cestelli 125x65 2 basket drawers</p>	G4401251/2	456	484			
 <p>angolo L 110 4 cestelli estraibili indipendenti dall'anta 1 anta L 45 (cerniere a pilastro) cassone 105 corner unit W 110 4 pull-out basket units opening independently from door 1 door W 45 (pillar hinges) structure 105</p> <p>verso dx RH version</p>							
	<p>110x65</p>	G4451101/2	943	963			
 <p>angolo L 125 4 cestelli estraibili indipendenti dall'anta 1 anta L 60 (cerniere a pilastro) cassone 120 corner unit W 125 4 pull-out basket units opening independently from door 1 door W 60 (pillar hinges) structure 120</p> <p>verso dx RH version</p>							
	<p>125x65</p>	G4451251/2	1.016	1.044			
 <p>angolo 95x95 1 ripiano 2 ante L 30 (cerniere 180°) angolare unito all'anta dx corner unit 95x95 1 shelf 2 doors W 30 (180° hinges) angular filler attached to the RH door</p>							
	<p>95x95</p>	G4480950	797	816			
 <p>angolo 110x110 1 ripiano 2 ante L 45 (cerniere 180°) angolare unito all'anta dx corner unit 110x110 1 shelf 2 doors W 45 (180° hinges) angular filler attached to the RH door</p>							
	<p>110x110</p>	G4481100	854	696			



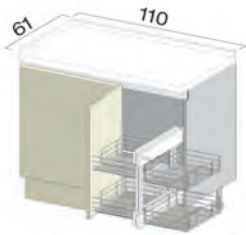
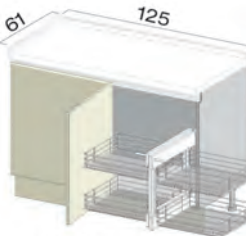

BASI ANGOLO PANNELLO COME ANTA

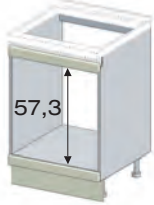

H 88 P 61

CORNER BASE UNITS PANEL AS DOOR

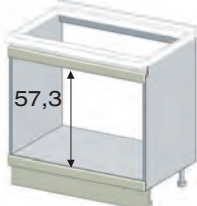
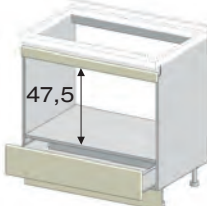



LE BASI NON SONO COMPRENSIVE DI TOP THE BASE UNITS DO NOT INCLUDE THE TOPS		COD.	MELAMINICO K36	LACCATO OPACO K37				
 <p>angolo L 110 1 ripiano 1 anta L 45 pannello come anta (impiallacciato per la versione melaminico) cassone 110 corner unit W 110 1 shelf 1 door W 45 panel as door (veneered panel for melamine version) structure 110</p> <p>verso dx RH version</p>	110x61	G4403091/2	507	499				
 <p>angolo L 125 1 ripiano 1 anta L 60 pannello come anta (impiallacciato per la versione melaminico) cassone 125 corner unit W 125 1 shelf 1 door W 60 panel as door (veneered panel for melamine version) structure 125</p> <p>verso dx RH version</p>	125x61	G4403241/2	513	513				
 <p>angolo L 110 4 cestelli estraibili indipendenti dall'anta 1 anta L 45 pannello come anta (impiallacciato per la versione melaminico) cassone 110 corner unit W 110 4 pull-out basket units opening independently from door 1 door W 45 panel as door (veneered panel for melamine version) structure 110</p> <p>verso dx RH version</p>	110x61	G4453101/2	1.037	1.029				
 <p>angolo L 125 4 cestelli estraibili indipendenti dall'anta 1 anta L 60 pannello come anta (impiallacciato per la versione melaminico) cassone 125 corner unit W 125 4 pull-out basket units opening independently from door 1 door W 60 panel as door (veneered panel for melamine version) structure 125</p> <p>verso dx RH version</p>	125x61	G4453251/2	1.103	1.103				
 <p>angolo L 110 2 cestelli mezzaluna 1 anta L 45 pannello come anta (impiallacciato per la versione melaminico) cassone 110 corner unit W 110 2 crescent-shaped wire basket units 1 door W 45 panel as door (veneered panel for melamine version) structure 110</p> <p>verso dx RH version</p>	110x61	G4403111/2	527	519				
 <p>angolo L 125 2 cestelli mezzaluna 1 anta L 60 pannello come anta (impiallacciato per la versione melaminico) cassone 125 corner unit W 125 2 crescent-shaped wire basket units 1 door W 60 panel as door (veneered panel for melamine version) structure 125</p> <p>verso dx RH version</p>	125x61	G4403261/2	543	543				

Le basi non sono comprensive di top - N.B.: cassetti ad estrazione totale con blumotion
 The base units do not include the tops - Note: fully extending drawers with blumotion system

	COD.	MELAMINICO K36	LACCATO OPACO K37				
 <p>base per forno elettrico e gas H 60 fascia superiore e inferiore H 5,7 electric and gas oven base unit H 60 upper and lower panel H 5,7</p>	L 60	G5510600	240	270			
 <p>base per forno elettrico H 46 fascia superiore H 8,9 cassetto inferiore H 16,9 presa su fondo electric oven base unit H 46 upper panel H 8,9 lower drawer H 16,9 grip on bottom opening</p>	L 60	G5530600	250	305			
 <p>base per maxiforno H 60 fascia superiore e inferiore H 5,7 maxi-oven base unit H 60 upper and lower panel H 5,7</p>	L 90	G5510900	314	298			
 <p>base per maxiforno H 48 fascia superiore H 6,7 cassetto inferiore H 16,9 presa su fondo maxi-oven base unit H 48 upper panel H 6,7 lower drawer H 16,9 grip on bottom opening</p>	L 90	G5530900	317	371			
 <p>kit raccordo base angolo junction kit for corner base unit</p>	110x110	G5471100	305	314			
 <p>kit raccordo base angolo per inserimento lavastoviglie a destra o sinistra junction kit for corner base unit for dishwasher placed on the right or the left side</p> <p>verso dx RH version</p>	110x110	G5471151/2	338	347			

Le basi non sono comprensive di top The base units do not include the tops		COD.	MELAMI- NICO K36	LACCATO OPACO K37				
 <p>base predisposta piano cottura 1 anta base unit configured for cooker hob 1 door</p>	<p>L 60</p> <p>mag.base piano cottura ad induzione surcharge base unit for induction cooker hob</p>	G5500601/2	237	243				
		opz.101	+55	+55				
 <p>base predisposta piano cottura 2 ante base unit configured for cooker hob 2 doors</p>	<p>L 90</p> <p>mag.base piano cottura ad induzione surcharge base unit for induction cooker hob</p>	G5500900	358	361				
		opz.101	+55	+55				
 <p>Maggiorazione per base predisposta piano cottura ad induzione con lamierino di protezione N.B.: realizzabile su base 2 cassetti+1 cestone, base 2 cestoni e base 4 cassetti Surcharge for base unit configured for induction cooker hob with protection metal sheet Note: available on base unit 2 drawers+1 deep drawer, base unit 2 deep drawers and base unit 4 drawers</p>		opz.101	+55	+55				

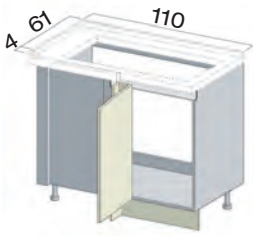
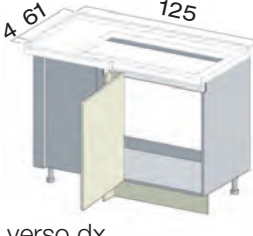
Le basi non sono comprensive di top - N.B.: cerniere ammortizzate di serie
 The base units do not include the tops - Note: standard blumotion hinges

	COD.	MELAMINICO K36	LACCATO OPACO K37					
 <p>sottolavello 1 anta sink base unit 1 door</p>	L 45	G5010451/2	203	211				
	L 60	G5010601/2	225	242				
 <p>sottolavello 2 ante sink base unit 2 doors</p>	L 60	G5010600	297	295				
	L 80	G5010800	329	344				
	L 90	G5010900	342	359				
	L 120	G5011200	390	423				
 <p>sottolavello 2 cestoni H 34,2 cestone superiore sagomato con vaschette sink base unit 2 deep drawers H 34,2 contoured upper deep drawer with trays</p>	L 60	G5200600	445	448				
	L 90	G5200900	531	526				
 <p>sottolavello angolo L 110 1 anta L 45 (cerniere pilastro) cassone 105 corner sink base unit W 110 1 door W 45 (pillar hinges) structure 105</p> <p>verso dx RH version</p>	110x65	G4421101/2	406	425				
 <p>sottolavello angolo L 125 1 anta L 60 (cerniere pilastro) cassone 120 corner sink base unit W 125 1 door W 60 (pillar hinges) structure 120</p> <p>verso dx RH version</p>	125x65	G4421251/2	432	460				
 <p>sottolavello angolo L 145 2 ante L 40 (cerniere pilastro) cassone 140 corner sink base unit W 145 2 doors W 40 (pillar hinges) structure 140</p> <p>verso dx RH version</p>	145x65	G4421451/2	523	546				

Le basi non sono comprensive di top - N.B.: cerniere ammortizzate di serie
 The base units do not include the tops - Note: standard blumotion hinges

COD.

MELAMI-
NICO
K36

LACCATO
OPACO
K37



verso dx
RH version

sottolavello angolo L 155
2 ante L 45 (cerniere pilastro)
cassone 150

corner sink base unit W 155
 2 doors W 45 (pillar hinges)
 structure 150

155x65

G4421551/2

543

568

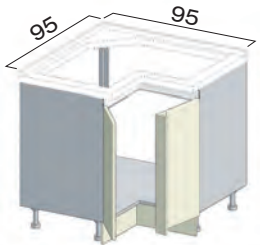

sottolavello angolo 95x95
2 ante L 30 (cerniere 180°)
angolare unito all'anta dx

corner sink base unit 95x95
 2 doors W 30 (180° hinges)
 angular filler attached to the RH door

95x95

G5020950

711

725

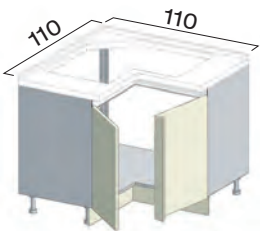

sottolavello angolo 110x110
2 ante L 45 (cerniere 180°)
angolare unito all'anta dx

corner sink base unit 110x110
 2 doors W 45 (180° hinges)
 angular filler attached to the RH door

110x110

G5021100

714





745





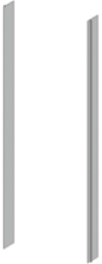
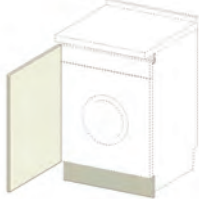
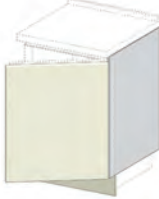

NELLE INTERRUZIONI DI GOLA, AGGIUNGERE
SEMPRE I RELATIVI TERMINALI
 ADD. THE ASSOCIATED CLOSURES TO ANY
 INTERRUPTIONS IN THE FINGER RAIL

BASI PER ELETTRODOMESTICI SOTTOTOP

H 88 P 61

BASE UNITS FOR UNDER-TOP APPLIANCES

Le basi non sono comprensive di top The base units do not include the tops		COD.	MELAMINICO K36	LACCATO OPACO K37				
 <p>anta per lavastoviglie scomparsa totale completa di kit protezione fianchi door for fully integrated dishwasher with protection kit for side panels</p>	L 45	G4490080	163	155				
	L 60	G4490090	172	174				
 <p>anta per lavastoviglie a scomparsa totale estetica 2 cestoni completa di kit protezione fianchi door for aesthetic fully integrated dishwasher 2 deep drawers with protection kit for side panels</p>	L 60	G4490300	353	360				
	 <p>kit protezione fianchi per lavastoviglie protection kit for side panels for dishwasher</p> 							
 <p>anta per lavabiancheria scomparsa totale door for fully integrated washing machine</p>	L 60	G4490011/2	158	174				
	 <p>anta con fianco per frigo e congelatore sottotop door with side panel for under-top fridge and freezer</p>	L 60	G4490151/2	197	199			
 <p>anta per frigo e congelatore sottotop door for under-top fridge and freezer</p>		L 60	G4490181/2	172	174			
	 <p>fianco per elettrodomestici a fine composizione side panel for appliances placed at the end of the composition</p>	<p>in nobilitato melamine coated H 88x59,9x1,8 zoccolo H 13 plinth</p>		G94612	29	29		
<p>come anta same as door H 88x59,9x1,8 zoccolo H 13 plinth</p>		G94712	133	183				



Le basi non sono comprensive di top - N.B.: cerniere ammortizzate di serie The base units do not include the tops - Note: standard blumotion hinges		COD.	MELAMI- NICO K36	LACCATO OPACO K37				
 <p>base H 76 1 anta base unit H 76 1 door</p>	L 45	G4030451/2	204	207				
	L 60	G4030601/2	230	240				
	L 90	G4030900	349	355				
 <p>base H 76 2 ante base unit H 76 2 doors</p>	L 45	G4255450	419	413				
	L 60	G4255600	481	457				
	L 90	G4255900	578	553				
 <p>base H 76 1 cassetto H 22,2 2 cassetti H 16,9 base unit H 76 1 drawer H 22,2 2 drawers H 16,9</p>	L 45	G4260450	339	352				
	L 60	G4260600	384	383				
	L 90	G4260900	466	466				
 <p>base H 76 1 cassetto H 22,2 1 cassetto H 34,2 base unit H 76 1 drawer H 22,2 1 deep drawer H 34,2</p>	L 45	G5540600	241	270				
	L 60	G5540600	241	270				
	L 90	G5540600	241	270				
 <p>base H 76 predisposta per forno elettrico compatto H 46 1 fascia superiore H 7,4 1 fascia inferiore H 5,5 base unit H 76 configured for compact electric oven H 46 1 upper panel H 7,4 1 lower panel H 5,5</p>	L 45	G4590600	419	425				
	L 60	G4590600	419	425				
	L 90	G4590600	419	425				
 <p>base H 76 predisposta per lavastoviglie Electrolux ESL 2450 RO 1 anta H 42,2 1 fascia H 5,9 e 1 cassetto H 10,9 base unit H 76 configured for Electrolux ESL 2450 RO dishwasher 1 door H 42,2 1 panel H 5,9 and 1 drawer H 10,9</p>	L 45	G4590600	419	425				
	L 60	G4590600	419	425				
	L 90	G4590600	419	425				







SOTTOLAVELLI H 76

H 76 P 61

SINK BASE UNITS H 76

Le basi non sono comprensive di top - N.B.: cerniere ammortizzate di serie
 The base units do not include the tops - Note: standard blumotion hinges





	COD.	MELAMINICO K36	LACCATO OPACO K37					
 <p>sottolavello H 76 1 anta sink base unit H 76 1 door</p>	L 45	G5060451/2	214	214				
	L 60	G5060601/2	236	242				
 <p>sottolavello H 76 2 ante sink base unit H 76 2 doors</p>	L 90	G5060900	355	357				
	L 120	G5061200	402	418				
 <p>sottolavello H 76 1 cestone H 59,7 con scarico salvaspazio sink base unit H 76 1 deep drawer H 59,7 with space-saver drain piping</p>	L 60	G5260600	307	313				
	L 90	G5260900	368	380				
<p>NELLE INTERRUZIONI DI GOLA, AGGIUNGERE SEMPRE I RELATIVI TERMINALI ADD.THE ASSOCIATED CLOSURES TO ANY INTERRUPTIONS IN THE FINGER RAIL</p>								

Le basi non sono comprensive di top - N.B.: cerniere ammortizzate di serie The base units do not include the tops - Note: standard blumotion hinges		COD.	MELAMI-NICO	LACCATO OPACO				
			K36	K37				
 <p>base H 37,5 1 anta H 34,2 base unit H 37,5 1 door H 34,2</p>								
	L 45	G4321451/2	201	217				
	L 60	G4321601/2	218	221				
 <p>base H 51 1 anta H 47,7 base unit H 51 1 door H 47,7</p>								
	L 45	G4320451/2	212	218				
	L 60	G4320601/2	233	239				
 <p>base H 63 1 anta H 59,7 base unit H 63 1 door H 59,7</p>								
	L 45	G4322451/2	222	225				
	L 60	G4322601/2	241	251				
 <p>base H 37,5 2 ante H 34,2 base unit H 37,5 2 doors H 34,2</p>								
	L 90	G4321900	302	334				
	L 120	G4322200	340	347				
 <p>base H 51 2 ante H 47,7 base unit H 51 2 doors H 47,7</p>								
	L 90	G4320900	327	340				
	L 120	G4321200	376	389				
 <p>base H 63 2 ante H 59,7 base unit H 63 2 doors H 59,7</p>								
	L 90	G4322900	350	356				

BASI SOSPESSE con Attaccaglie e Barre Fissaggio a parete

H 37,5 - 51 - 63 P 61

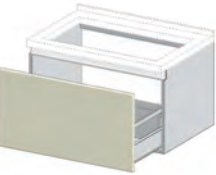
HANGING BASE UNITS with Hangers and Rods for wall mounting

Le basi non sono comprensive di top - N.B.: cassetti e cestoni ad estrazione totale con blumotion The base units do not include the tops - Note: fully extending drawers and deep drawers with blumotion system		COD.	MELAMINICO K36	LACCATO OPACO K37				
 <p>base H 37,5 1 cestone H 34,2 base H 37,5 1 deep drawer H 34,2</p>	L 45	G4311450	246	262				
	L 60	G4311600	266	270				
	L 90	G4311900	319	318				
 <p>base H 51 1 cestone H 47,7 base unit H 51 1 deep drawer H 47,7</p>	L 45	G4310450	250	256				
	L 60	G4310600	272	279				
	L 90	G4310900	327	333				
 <p>base H 63 1 cestone H 59,7 1 cassetto interno base unit H 63 1 deep drawer H 59,7 1 internal drawer</p>	L 45	G4312450	357	360				
	L 60	G4312600	385	394				
	L 90	G4312900	456	472				
 <p>sottolavello H 51 1 cestone sagomato H 47,7 scarico salvaspazio sink base unit H 51 1 contoured deep drawer H 47,7 space-saver drain piping</p>	L 90	G5240900	373	375				
 <p>sottolavello H 63 1 cestone H 59,7 scarico salvaspazio sink base unit H 63 1 deep drawer H 59,7 with space-saver drain piping</p>	L 60	G5250600	325	331				
	L 90	G5250900	376	387				

COMPOSIZIONE CON ELEMENTI INCLINATI

COMPOSITION WITH INCLINED ELEMENTS

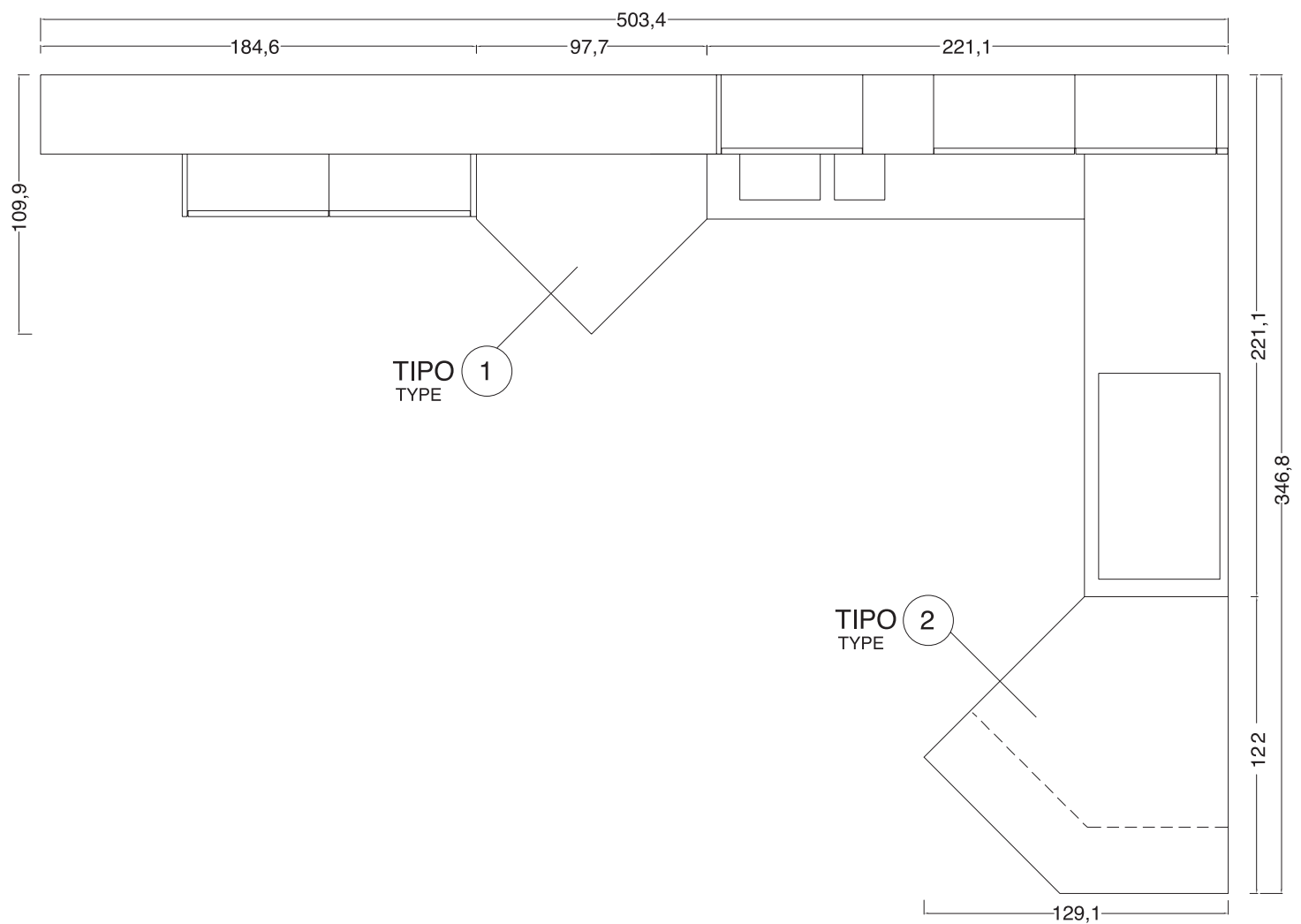
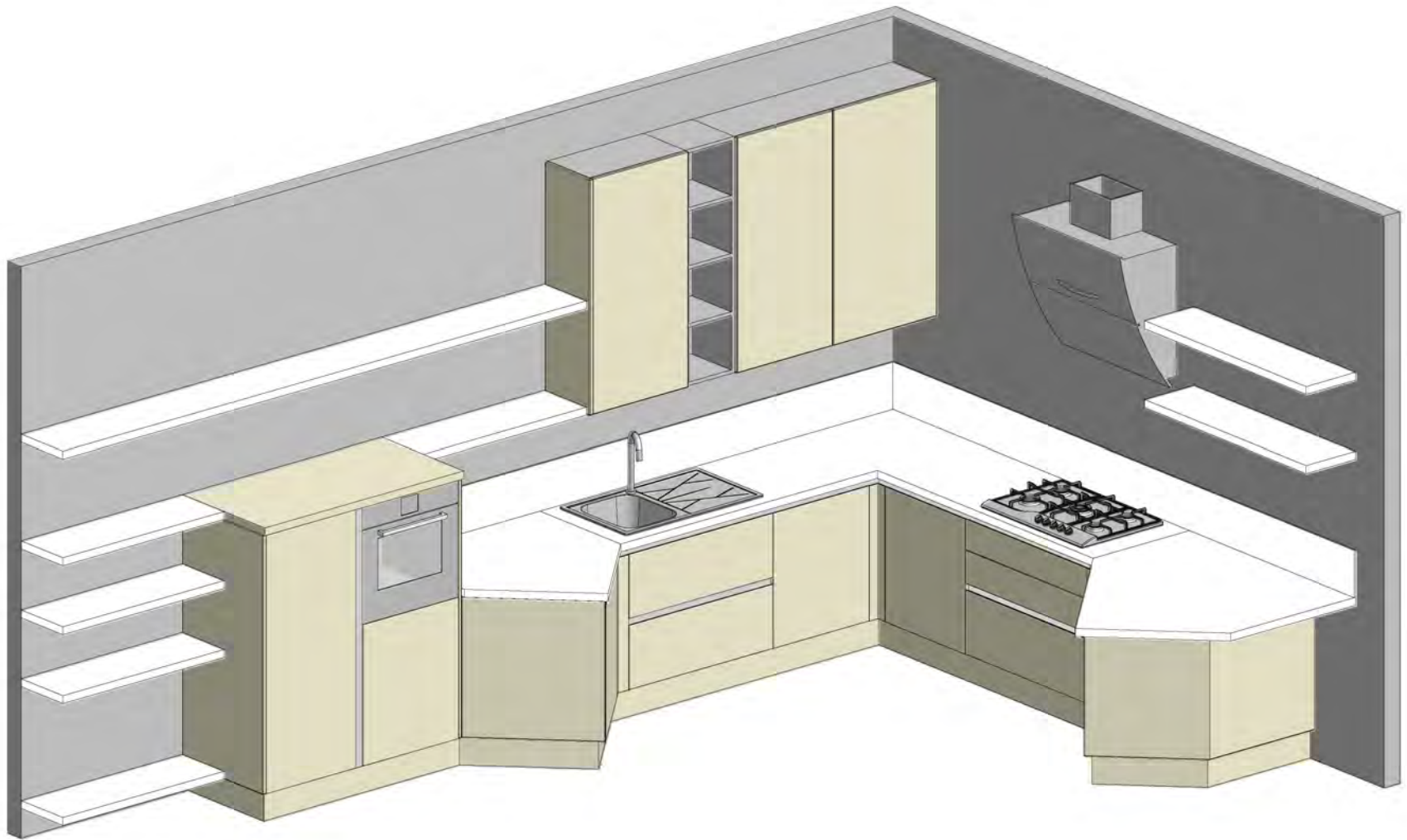

BASE INCLINATA "TIPO 1"

INCLINED BASE UNIT "TYPE 1"

LE BASI NON SONO COMPRENSIVE DI TOP
THE BASE UNITS DO NOT INCLUDE THE TOPS

kit base inclinata "tipo 1" per vano L 60 (pannelli senza cornice)

inclined base unit "type 1" kit W 60
(panels without frame)

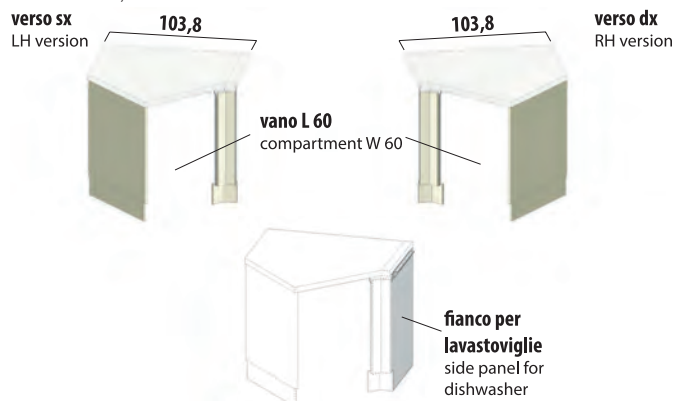

kit "tipo 1"
"type 1" kit

mag. inserimento fianco per lavastoviglie dx o sx
surcharge for dishwasher side panel placed on RH or LH side

top per base inclinata "tipo 1"

worktop for inclined base unit "type 1"

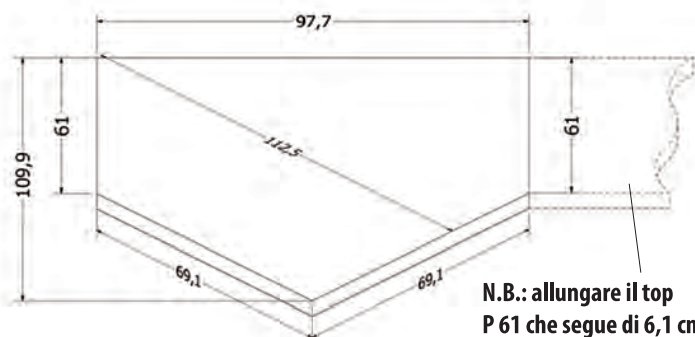

verso sx
LH version

N.B.: allungare il top P 61 che segue di 6,1 cm
Note: add. 6,1 cm to the worktop next to the inclined base unit

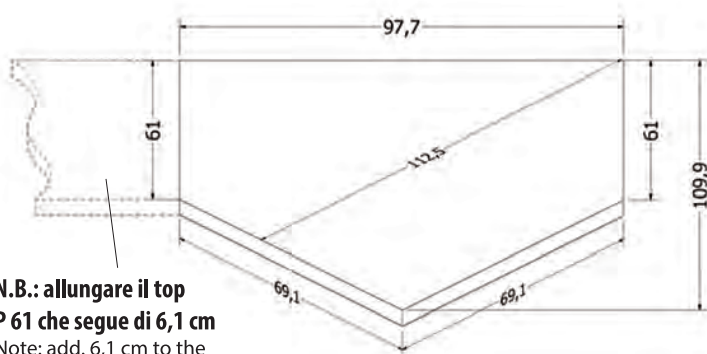

verso dx
RH version

N.B.: allungare il top P 61 che segue di 6,1 cm
Note: add. 6,1 cm to the worktop next to the inclined base unit

97,7x109,9 lamin.bordo ABS1

H 4

T9062621/2

422

422

97,7x109,9 laminato Fenix
NTM

H 2

TFEN2681/2

428

428

H 4

TFEN4681/2

428

428

97,7x109,9 quarzo pasta piena
profilo P

H 2

TQRP2681/2

fascia "A"

840

840

fascia "B"

896

896

fascia "C"

968

968

H 3

TQRP3681/2

fascia "A"

859

859

fascia "B"

952

952

fascia "C"

1.024

1.024

97,7x109,9 quarzo bordo
quarzo profilo P

H 4

TQRP4681/2

fascia "A"

1.002

1.002

fascia "B"

1.096

1.096

fascia "C"

1.168

1.168

BASE INCLINATA SNACK "TIPO 2"

INCLINED SNACK BASE UNIT "TYPE 2"

LE BASI NON SONO COMPRENSIVE DI TOP
THE BASE UNITS DO NOT INCLUDE THE TOPS

COD.

MELAMI-
NICO
K36

LACCATO
OPACO
K37

kit base snack "tipo 2" per vano L 60 (pannelli senza cornice)

inclined snack base unit "type 2" kit W 60
(panels without frame)

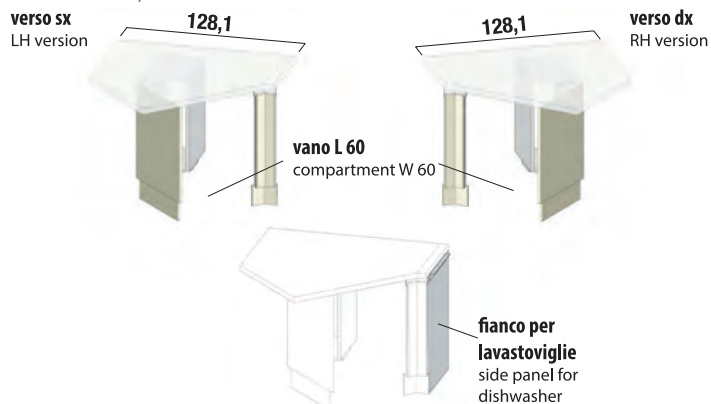

kit "tipo 2"
"type 2" kit

G4910071/2

300

504

opz.002

+40

+40

mag. inserimento fianco per lavastoviglie dx o sx
surcharge for dishwasher side panel placed on RH or LH side

top per base snack "tipo 2"

worktop for inclined snack base unit "type 2"

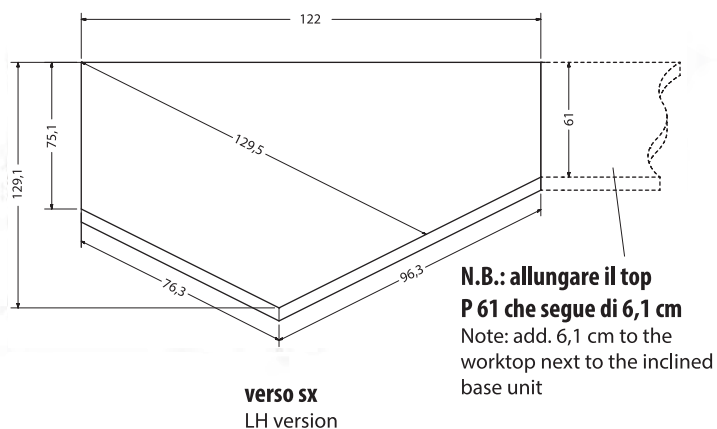

verso sx
LH version

N.B.: allungare il top P 61 che segue di 6,1 cm
Note: add. 6,1 cm to the worktop next to the inclined base unit

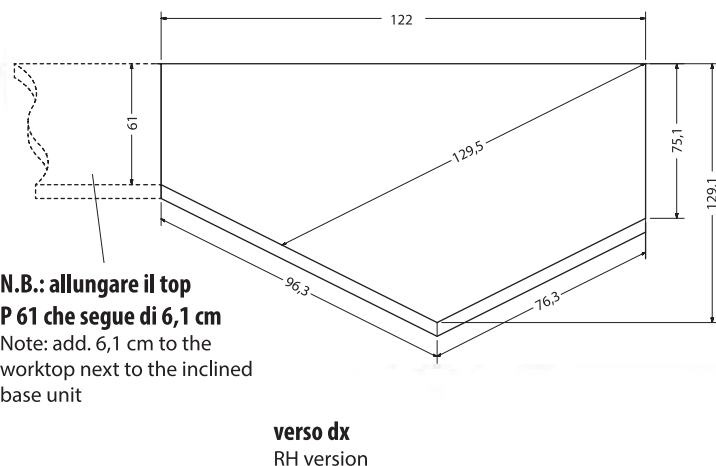

verso dx
RH version

N.B.: allungare il top P 61 che segue di 6,1 cm
Note: add. 6,1 cm to the worktop next to the inclined base unit

122x129,1 lamin.bordo ABS1

H 4

T9062631/2

429

429

122x129,1 laminato Fenix
NTM

H 2

TFEN2691/2

519

519

H 4

TFEN4691/2

519

519

122x129,1 quarzo pasta
piena profilo P

H 2

TQRP2691/2

fascia "A"

865

865

fascia "B"

959

959

fascia "C"

1.030

1.030

H 3

TQRP3691/2

fascia "A"

885

885

fascia "B"

975

975

fascia "C"

1.044

1.044

Foro rettangolare

T9FRE

85

85

122x129,1 quarzo bordo
quarzo profilo P

H 4

TQRP4691/2

fascia "A"

1.065

1.065

fascia "B"

1.158

1.158

fascia "C"

1.230

1.230

Foro rettangolare

T9FRE

85

85



GOLE PER COLONNE

COLUMNS FINGER RAILS

NELLE COLONNE PER L'APERTURA DELLE ANTE E' OBBLIGATORIO L'INSERIMENTO DELLE GOLE VERTICALI
VERTICAL FINGER RAILS MUST BE FITTED TO COLUMNS WITH OPENING DOORS

COD.

MELAMI-
NICO
K36

LACCATO
OPACO
K37

mezza gola elle verticale tipo "C"
 elle half finger rail type "C"

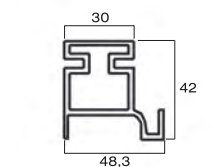

Sezione gola tipo "C"
 Type "C" finger rail section

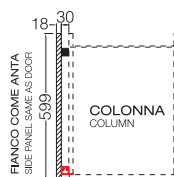

gola
 finger rail

H 96	G950310	63	63
H 132	G950330	83	83
H 204	G950350	123	123
H 228	G950370	136	136
*gola con fianco come anta montato *finger rail mounted on side panel same as door			
H 96	G950319	199	228
H 132	G950339	261	306
H 204	G950359	361	458
H 228	G950379	395	518

gola elle verticale intermedia tipo "D"
 elle vertical intermediate finger rail type "D"

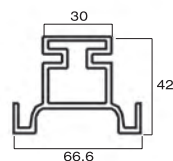

Sezione gola tipo "D"
 Type "D" finger rail section

gola
 finger rail

H 96	G950410	63	63
H 132	G950430	83	83
H 204	G950450	123	123
H 228	G950470	136	136

gola elle verticale laterale tipo "E"
 elle vertical lateral finger rail type "E"

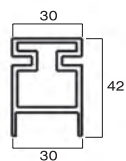



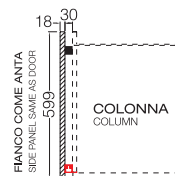





Sezione gola tipo "E"
 Type "E" finger rail section







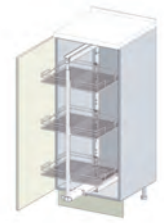





gola
 finger rail

H 96	G950510	63	63
H 132	G950530	83	83
H 204	G950550	123	123
H 228	G950570	136	136
*gola con fianco come anta montato *finger rail mounted on side panel same as door			
H 96	G950519	199	228
H 132	G950539	261	306
H 204	G950559	361	458
H 228	G950579	395	518



Le colonne non sono comprensive di top - N.B.: cerniere ammortizzate di serie The columns do not include the tops - Note: standard blumotion hinges		COD.	MELAMINICO K36	LACCATO OPACO K37				
 <p>fascia tamponamento da 5 a 10 N.B.: realizzata con cornice come anta filler panel size from 5 to 10 Note: realized with frame as door</p>								
	<p>in nobilitato melamine coated</p>	G6000010	50	50				
	<p>come anta con supporto same as door with support</p>	G6000140	142	151				
 <p>1 anta 1 door</p>								
	L 30	G6040301/2	236	231				
	L 40	G6040401/2	254	259				
	L 45	G6040451/2	264	269				
	L 60	G6040601/2	297	318				
 <p>*1 anta (cerniere 180°) 2 cassetti interni 1 cestone interno *1 door (180° hinges) 2 internal drawers 1 internal deep drawer</p>								
	L 45	G6041461/2	461	466				
	L 60	G6041611/2	495	516				
 <p>jolly colonna L da 10 a 30 jolly column size from 10 to 30</p>								
	colore come struttura same colour as carcass	E6000900	175	175				
	melaminico come anta melamine same as door	E6000930	253	—				
	laccato come anta lacquered same as door	E6006050	—	579				
<p>NELLE COLONNE PER L'APERTURA DELLE ANTE E' OBBLIGATORIO L'INSERIMENTO DELLE GOLE VERTICALI VERTICAL FINGER RAILS MUST BE FITTED TO COLUMNS WITH OPENING DOORS</p>								
<p>*LE COLONNE CON CASSETTI E CESTONI INTERNI VANNO SEMPRE POSIZIONATE A 5 CM DALLA PARETE LATERALE *COLUMNS WITH INTERNAL DRAWERS AND DEEP DRAWERS SHOULD ALWAYS BE PLACED 5 CM FROM THE SIDE WALL</p>								





Le colonne non sono comprensive di top - N.B.: cerniere ammortizzate di serie The columns do not include the tops - Note: standard blumotion hinges		COD.	MELAMINICO K36	LACCATO OPACO K37				
 <p>fascia tamponamento da 5 a 10 N.B.: realizzata con cornice come anta filler panel size from 5 to 10 Note: realized with frame as door</p>								
	<p>in nobilitato melamine coated</p>	G6000020	51	51				
	<p>come anta con supporto same as door with support</p>	G6000150	144	187				
 <p>1 anta 1 door</p>								
	L 30	G6050301/2	281	272				
	L 45	G6050451/2	318	328				
 <p>1 anta integrata al gruppo cestelli estraibili in filo cromati chiusura soft 1 door incorporated into the chromed wire pull-out basket units soft-closing system</p>								
	L 60	G6050601/2	356	383				
	L 30	G6150300	517	508				
 <p>1 anta gruppo cestelli estraibili in filo cromati chiusura soft 1 door chromed wire pull-out basket units soft-closing system</p>								
	L 45	G6150451/2	557	567				
	L 60	G6150601/2	609	634				
 <p>angolo 2 ripiani con tirante 1 anta (cerniere a pilastro) pannello come anta sp.2,2 (impiallacciato per la versione melaminico) corner unit 2 shelves with tie beam 1 door (hinges pillar) panel as door Th. 2,2 (veneered panel for melamine version)</p>								
	L 110	G6336101/2	700	689				
	L 125	G6336251/2	725	700				
 <p>jolly colonna L da 10 a 30 jolly column size from 10 to 30</p>								
	<p>colore come struttura same colour as carcass</p>	E6001000	203	203				
	<p>melaminico come anta melamine same as door</p>	E6001030	315	—				
	<p>laccato come anta lacquered same as door</p>	E6006100	—	759				







N.B.: cerniere ammortizzate di serie Note: standard blumotion hinges		COD.	MELAMINICO K36	LACCATO OPACO K37				
 <p>204</p> <p>fascia tamponamento da 5 a 10 N.B.: realizzata con cornice come anta filler panel size from 5 to 10 Note: realized with frame as door</p>								
	in nobilitato melamine coated	G6000050	58	58				
	come anta con supporto same as door with support	G6000200	235	307				
 <p>2 ante anta superiore H 72 anta inferiore H 132 2 doors upper door H 72 lower door H 132</p>	L 45 P 33,4	G6013451/2	431	446				
	L 60 P 33,4	G6013601/2	492	535				
 <p>2 ante anta superiore H 72 anta inferiore H 132 2 doors upper door H 72 lower door H 132</p>	L 30 P 59,9	G6060301/2	429	416				
	L 45 P 59,9	G6063451/2	481	496				
	L 60 P 59,9	G6063601/2	550	593				
 <p>2 ante anta superiore H 132 anta inferiore H 72 2 doors upper door H 132 lower door H 72</p>	L 45 P 33,4	G6010451/2	431	446				
	L 60 P 33,4	G6010601/2	492	535				
 <p>2 ante anta superiore H 132 anta inferiore H 72 2 doors upper door H 132 lower door H 72</p>	L 45 P 59,9	G6060451/2	481	496				
	L 60 P 59,9	G6060601/2	550	593				
<p>NELLE COLONNE PER L'APERTURA DELLE ANTE E' OBBLIGATORIO L'INSERIMENTO DELLE GOLE VERTICALI VERTICAL FINGER RAILS MUST BE FITTED TO COLUMNS WITH OPENING DOORS</p>								



N.B.: cerniere ammortizzate di serie Note: standard blumotion hinges		COD.	MELAMI-	LACCATO				
			NICO	OPACO				
			K36	K37				
 <p>portascoppe 2 ante anta superiore H 72 anta inferiore H 132 broom cabinet 2 doors upper door H 72 lower door H 132</p>	L 30	G6100301/2	428	415				
	L 45	G6100451/2	472	488				
 <p>portascoppe con ripiani 2 ante anta superiore H 72 anta inferiore H 132 broom cabinet with shelves 2 doors upper door H 72 lower door H 132</p>	L 60	G6100601/2	560	603				
 <p>1 anta H 204 1 door H 204</p>	L 45	G6061451/2	470	489				
	L 60	G6061601/2	517	601				
 <p>portascoppe 1 anta H 204 broom cabinet 1 door H 204</p>	L 45	G6100461/2	450	469				
 <p>portascoppe con ripiani 1 anta H 204 broom cabinet with shelves 1 door H 204</p>	L 60	G6100611/2	525	609				
 <p>anta H 204 integrata al gruppo cestelli estraibili in filo cromati chiusura soft door H 204 incorporated into the chromed wire pull-out basket unit soft-closing system</p>	L 30	G6163300	710	705				
	L 45	G6163450	779	796				

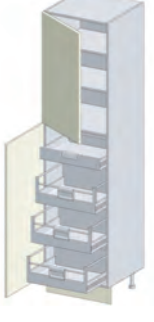

N.B.: cerniere ammortizzate di serie Note: standard blumotion hinges		COD.	MELAMI- NICO K36	LACCATO OPACO K37					
	1 anta superiore H 72 1 anta H 132 integrata al gruppo cestelli estraibili in filo cromati chiusura soft 1 upper door H 72 1 door H 132 incorporated into the chromed wire pull-out basket units soft-closing system	L 30	G6160301/2	653	641				
		1 anta superiore H 72 1 anta inferiore H 132 gruppo cestelli estraibili in filo cromati chiusura soft 1 upper door H 72 1 lower door H 132 chromed wire pull-out basket units soft-closing system	L 45	G6160451/2	710	725			
L 60		G6160601/2	778	817					
		*1 anta superiore H 72 (cerniere 100°) 1 anta inferiore H 132 (cerniere 180°) 1 cassetto interno 3 cestoni interni *1 upper door H 72 (100° hinges) 1 lower door H 132 (180° hinges) 1 internal drawer 3 internal deep drawers	L 45	G6080481/2	715	719			
	L 60	G6080631/2	782	808					
		*1 anta superiore H 132 (cerniere 100°) 1 anta inferiore H 72 (cerniere 180°) 4 cassetti interni *1 upper door H 132 (100° hinges) 1 lower door H 72 (180° hinges) 4 internal drawers	L 45	G6065451/2	690	715			
L 60		G6065601/2	757	811					
		*1 anta superiore H 132 (cerniere 100°) 1 anta inferiore H 72 (cerniere 180°) 2 cassetti interni 1 cestone interno *1 upper door H 132 (100° hinges) 1 lower door H 72 (180° hinges) 2 internal drawers 1 internal deep drawer	L 45	G6065461/2	639	664			
	L 60	G6065611/2	699	752					
		*1 anta superiore H 132 (cerniere 100°) 1 anta inferiore H 72 (cerniere 180°) 2 cestoni interni *1 upper door H 132 (100° hinges) 1 lower door H 72 (180° hinges) 2 internal deep drawers	L 45	G6066451/2	587	612			
L 60		G6066601/2	646	699					

N.B.: cerniere ammortizzate di serie Note: standard blumotion hinges		COD.	MELAMINICO K36	LACCATO OPACO K37				
 <p>angolo 4 ripiani con tirante 1 anta superiore H 72 1 anta inferiore H 132 (cerniere a pilastro) pannello come anta sp.2,2 (impiallacciato per la versione melaminico) corner unit 4 shelves with tie beam 1 upper door H 72 1 lower door H 132 (pillar hinges) panel as door Th. 2,2 (veneered panel for melamine version)</p>	L 110	G6306101/2	1.035	1.023				
	L 125	G6306251/2	1.045	1.038				
 <p>angolo 8 cestelli estraibili 1 anta superiore H 72 1 anta inferiore H 132 pannello come anta sp.2,2 (impiallacciato per la versione melaminico) corner unit 8 pull-out basket units 1 upper door H 72 1 lower door H 132 panel as door Th. 2,2 (veneered panel for melamine version)</p>	L 110	G6308101/2	1.607	1.595				
	L 125	G6308251/2	1.617	1.610				
 <p>jolly colonna L da 15 a 30 jolly column size from 15 to 30</p>								
		colore come struttura same colour as carcass	E6002000	239	239			
		melaminico come anta melamine same as door	E6002030	428	—			
	laccato come anta lacquered same as door	E6006200	—	1.101				
<p>NELLE COLONNE PER L'APERTURA DELLE ANTE E' OBBLIGATORIO L'INSERIMENTO DELLE GOLE VERTICALI VERTICAL FINGER RAILS MUST BE FITTED TO COLUMNS WITH OPENING DOORS</p>								
<p>*LE COLONNE CON CASSETTI E CESTONI INTERNI VANNO SEMPRE POSIZIONATE A 5 CM DALLA PARETE LATERALE *COLUMNS WITH INTERNAL DRAWERS AND DEEP DRAWERS SHOULD ALWAYS BE PLACED 5 CM FROM THE SIDE WALL</p>								

N.B.: cerniere ammortizzate di serie Note: standard blumotion hinges		COD.	MELAMINICO K36	LACCATO OPACO K37				
 <p>fascia tamponamento da 5 a 10 N.B.: realizzata con cornice come anta filler panel size from 5 to 10 Note: realized with frame as door</p> <p>228</p>	in nobilitato melamine coated	G6000100	58	58				
	come anta con supporto same as door with support	G6000250	250	307				
 <p>2 ante anta superiore H 96 anta inferiore H 132 2 doors upper door H 96 lower door H 132</p>	L 45 P 33,4	G6023451/2	504	526				
	L 60 P 33,4	G6023601/2	577	640				
 <p>2 ante anta superiore H 96 anta inferiore H 132 2 doors upper door H 96 lower door H 132</p>	L 30 P 59,9	G6070301/2	471	454				
	L 45 P 59,9	G6073451/2	528	551				
	L 60 P 59,9	G6073601/2	610	674				
 <p>2 ante anta superiore H 156 anta inferiore H 72 2 doors upper door H 156 lower door H 72</p>	L 45 P 33,4	G6020451/2	512	526				
	L 60 P 33,4	G6020601/2	581	640				
 <p>2 ante anta superiore H 156 anta inferiore H 72 2 doors upper door H 156 lower door H 72</p>	L 45 P 59,9	G6070451/2	536	551				
	L 60 P 59,9	G6070601/2	614	674				
<p>NELLE COLONNE PER L'APERTURA DELLE ANTE E' OBBLIGATORIO L'INSERIMENTO DELLE GOLE VERTICALI VERTICAL FINGER RAILS MUST BE FITTED TO COLUMNS WITH OPENING DOORS</p>								

N.B.: cassetti e cestoni ad estrazione totale con blumotion Note: fully extending drawers and deep drawers with blumotion system		COD.	MELAMI-	LACCATO					
			NICO	OPACO					
			K36	K37					
 <p>portascope 1 anta superiore H 96 1 anta inferiore H 132 broom cabinet 1 upper door H 96 1 lower door H 132</p>	L 30	G6110301/2	468	451					
	L 45	G6110451/2	520	534					
 <p>portascope con ripiani 1 anta superiore H 96 1 anta inferiore H 132 broom cabinet with shelves 1 upper door H 96 1 lower door H 132</p>	L 60	G6110601/2	606	655					
 <p>1 anta superiore H 96 1 anta H 132 integrata al gruppo cestelli estraibili in filo cromati chiusura soft 1 upper door H 96 1 door H 132 incorporated into the chromed wire pull-out basket units soft-closing system</p>	L 30	G6170301/2	690	675					
 <p>1 anta superiore H 96 1 anta inferiore H 132 gruppo cestelli estraibili in filo cromati chiusura soft 1 upper door H 96 1 lower door H 132 chromed wire pull-out basket units soft-closing system</p>	L 45	G6170451/2	754	767					
	L 60	G6170601/2	833	877					
 <p>*1 anta superiore H 96 (cerniere 100°) 1 anta inferiore H 132 (cerniere 180°) 1 cassetto interno 3 cestoni interni *1 upper door H 96 (100° hinges) 1 lower door H 132 (180° hinges) 1 internal drawer 3 internal deep drawers</p>	L 45	G6082481/2	758	750					
	L 60	G6082631/2	836	853					
 <p>*1 anta superiore H 156 (cerniere 100°) 1 anta inferiore H 72 (cerniere 180°) 4 cassetti interni *1 upper door H 156 (100° hinges) 1 lower door H 72 (180° hinges) 4 internal drawers</p>	L 45	G6075451/2	741	770					
	L 60	G6075601/2	809	884					



N.B.: cassetti e cestoni ad estrazione totale con blumotion Note: fully extending drawers and deep drawers with blumotion system		COD.	MELAMINICO K36	LACCATO OPACO K37				
 <p> *1 anta superiore H 156 (cerniere 100°) 1 anta inferiore H 72 (cerniere 180°) 2 cassetti interni 1 cestone interno *1 upper door H 156 (100° hinges) 1 lower door H 72 (180° hinges) 2 internal drawers 1 internal deep drawer </p>	L 45	G6075461/2	689	718				
	L 60	G6075611/2	756	831				
 <p> *1 anta superiore H 156 (cerniere 100°) 1 anta inferiore H 72 (cerniere 180°) 2 cestoni interni *1 upper door H 156 (100° hinges) 1 lower door H 72 (180° hinges) 2 deep drawers H 36 </p>	L 45	G6076451/2	638	667				
	L 60	G6076601/2	703	778				
<p> NELLE COLONNE PER L'APERTURA DELLE ANTE E' OBBLIGATORIO L'INSERIMENTO DELLE GOLE VERTICALI VERTICAL FINGER RAILS MUST BE FITTED TO COLUMNS WITH OPENING DOORS </p>								
<p> *LE COLONNE CON CASSETTI E CESTONI INTERNI VANNO SEMPRE POSIZIONATE A 5 CM DALLA PARETE LATERALE *COLUMNS WITH INTERNAL DRAWERS AND DEEP DRAWERS SHOULD ALWAYS BE PLACED 5 CM FROM THE SIDE WALL </p>								

N.B.: cerniere ammortizzate di serie Note: standard blumotion hinges		COD.	MELAMINICO K36	LACCATO OPACO K37					
 <p>angolo 5 ripiani con tirante 1 anta superiore H 96 1 anta inferiore H 132 (cerniere a pilastro) pannello come anta sp. 2,2 (impiallacciato per la versione melaminico) corner unit 5 shelves with tie beam 1 upper door H 96 1 lower door H 132 (pillar hinges) panel as door Th. 2,2 (veneered panel for melamine version)</p>	L 110	G6316101/2	1.152	1.125					
	L 125	G6316251/2	1.172	1.158					
 <p>angolo 8 cestelli estraibili indipendenti all'anta 1 anta superiore H 96 1 anta inferiore H 132 pannello come anta sp. 2,2 (impiallacciato per la versione melaminico) corner unit 8 pull-out basket units independent from door 1 upper door H 96 1 lower door H 132 panel as door Th. 2,2 (veneered panel for melamine version)</p>	L 110	G6318101/2	1.724	1.697					
	L 125	G6318251/2	1.744	1.730					
 <p>jolly colonna L da 15 a 30 jolly column size from 15 to 30</p>									
		colore come struttura same colour as carcass	E6003000	267	267				
		melaminico come anta melamine same as door	E6003030	460	—				
	laccato come anta lacquered same as door	E6006250	—	1.230					
<p>NELLE COLONNE PER L'APERTURA DELLE ANTE E' OBBLIGATORIO L'INSERIMENTO DELLE GOLE VERTICALI VERTICAL FINGER RAILS MUST BE FITTED TO COLUMNS WITH OPENING DOORS</p>									

COLONNE H 109 - 128 PER FORNO

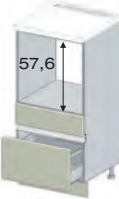

P 59,9

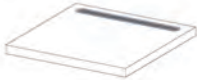
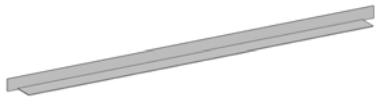
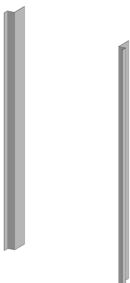
OVEN COLUMNS H 109 - 128

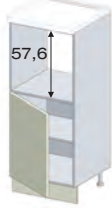
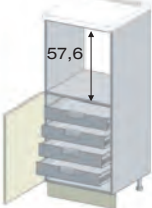
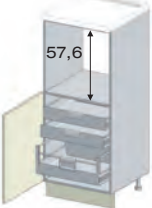
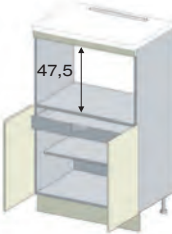

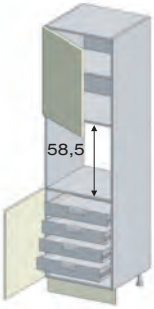
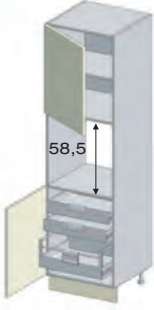
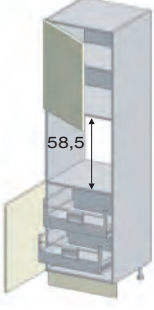
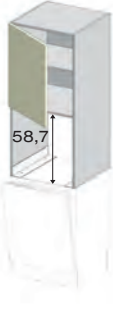

Le colonne non sono comprensive di top - N.B.: cassetti e cestoni ad estrazione totale con blumotion The columns do not include the tops - Note: fully extending drawers and deep drawers with blumotion system		COD.	MELAMINICO K36	LACCATO OPACO K37				
<p>colonna H 109 per forno 1 cestone chiuso H 35,7 oven column H 109 1 full deep drawer H 35,7</p> 								
	L 60	G6501600	290	294				
<p>colonna H 128 per forno con gola orizzontale 1 cassetto H 16,9 1 cestone H 34,2 oven column H 128 with horizontal finger rail 1 drawer H 16,9 1 deep drawer H 34,2</p> <p>N.B.: colonna da utilizzare con basi cestoni Note: column to use with deep drawer base units</p>  								
	L 60	G6510600	441	434				
<p>top H 1,8 come anta P 59,9 per colonne worktop H 1,8 same as door D 59,9 for columns</p> 								
		melaminico al ml melamine per 1m	TLE189	77	—			
		laccato al ml lacquered per 1m	TLC189	—	215			
		mag.griglia di areazione cad. surcharge for ventilation grille each	T9FGA	30	30			
<p>profilo in acciaio a "L" per rifinire il ripiano del forno e microonde L-shaped steel finishing profile for shelf of oven and microwave</p> 								
	L 60							
	inox stainless steel	08660100	9	9				
	nero black	08660101	9	9				
	bianco white	08660102	9	9				
L 90								
inox stainless steel	08660105	12	12					
<p>kit protezione fianchi per forno protection kit sides for oven</p> 								
	coppia couple	08630095	16	16				

Le colonne non sono comprensive di top - N.B.: cerniere ammortizzate di serie The columns do not include the tops - Note: standard blumotion hinges		COD.	MELAMI- NICO K36	LACCATO OPACO K37				
 <p>colonna H 145 per forno 1 anta H 72 apertura push-pull oven column H 145 1 door H 72 push-pull opening</p>	L 60	G6520601/2	299	313				
	<p>*colonna H 145 per forno 1 anta H 72 apertura push-pull (cerniere 180°) 4 cassetti interni oven column H 145 1 door H 72 push-pull opening (180°hinges) 4 internal drawers</p>							
 <p>*colonna H 145 per forno 1 anta H 72 apertura push-pull (cerniere 180°) 4 cassetti interni oven column H 145 1 door H 72 push-pull opening (180°hinges) 4 internal drawers</p>	L 60	G6521611/2	541	554				
	<p>*colonna H 145 per forno 1 anta H 72 apertura push-pull (cerniere 180°) 2 cassetti interni 1 cestone interno *oven column H 145 1 door H 72 push-pull opening (180°hinges) 2 internal drawers 1 internal deep drawer</p>							
 <p>*colonna H 145 per forno 1 anta H 72 apertura push-pull (cerniere 180°) 2 cassetti interni *oven column H 145 1 door H 72 push-pull opening (180°hinges) 2 internal drawers</p>	L 60	G6521621/2	487	501				
	<p>*colonna H 145 per forno 1 anta H 72 apertura push-pull (cerniere 180°) 2 cestoni interni *oven column H 145 1 door H 72 push-pull opening (180°hinges) 2 internal deep drawers</p>							
 <p>*colonna H 145 per forno per maxiforno H 48 1 cassetto interno 2 ante H 72 apertura push-pull (cerniere 180°) *oven column H 145 for maxi-oven H 48 1 internal drawer 2 doors H 72 push-pull opening (180°hinges)</p>	L 90	G6521950	690	686				
	<p>*LE COLONNE CON CASSETTI E CESTONI INTERNI VANNO SEMPRE POSIZIONATE A 5 CM DALLA PARETE LATERALE *COLUMNS WITH INTERNAL DRAWERS AND DEEP DRAWERS SHOULD ALWAYS BE PLACED 5 CM FROM THE SIDE WALL</p>							

N.B.: cassetti e cestoni ad estrazione totale con blumotion
 Note: fully extending drawers and deep drawers with blumotion system

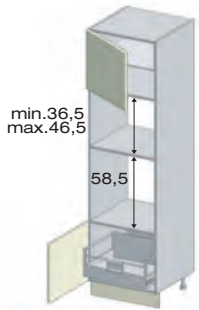
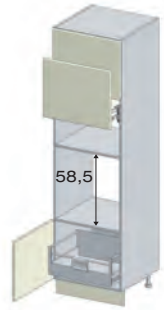
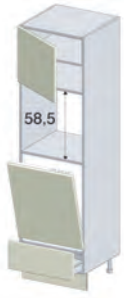

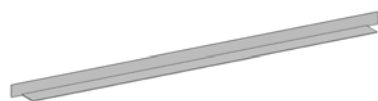

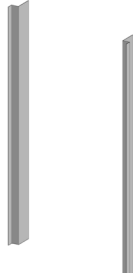
		MELAMI- NICO K36	LACCATO OPACO K37					
 <p>colonna per forno apertura push-pull 1 anta superiore H 72 1 anta inferiore H 72 oven column push-pull opening 1 upper door H 72 1 lower door H 72</p>	L 60	G6530601/2	468	496				
	 <p>*colonna per forno apertura push-pull 1 anta superiore H 72 1 anta inferiore H 72 (cerniere 180°) 4 cassetti interni *oven column push-pull opening 1 upper door H 72 1 lower door H 72 (180° hinges) 4 internal drawers</p>	L 60	G6531611/2	728	755			
 <p>*colonna per forno apertura push-pull 1 anta superiore H 72 1 anta inferiore H 72 (cerniere 180°) 2 cassetti interni 1 cestone interno *oven column push-pull opening 1 upper door H 72 1 lower door H 72 (180° hinges) 2 internal drawers 1 internal deep drawer</p>		L 60	G6531621/2	674	702			
	 <p>*colonna per forno apertura push-pull 1 anta superiore H 72 1 anta inferiore H 72 (cerniere 180°) 2 cestoni interni *oven column push-pull opening 1 upper door H 72 1 lower door H 72 (180° hinges) 2 internal deep drawers</p>	L 60	G6531631/2	621	648			
 <p>colonna forno sospesa H 132 per lavastoviglie 1 anta H 72 N.B.: inserire base lavastoviglie L 60 della versione Bridge hanging oven column H 132 for dishwasher 1 door H 72 Note: do insert dishwasher base unit for the Bridge version</p>		L 60	G6576601/2	329	344			
	 <p>fianco per colonna sospesa a fine composizione side panel for hanging column placed at the end of the composition</p>							
			T94370	236	271			

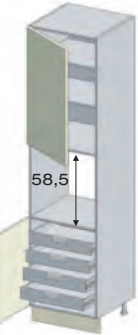
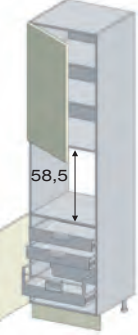
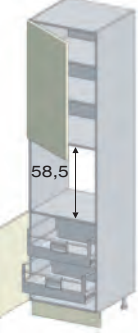

come anta
 same as door
 H 217x59,9x1,8 zoccolo H 13
 plinth

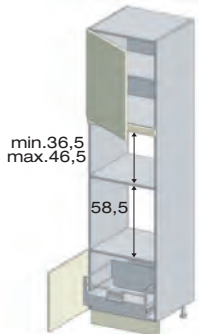
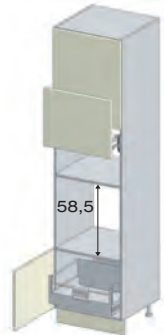
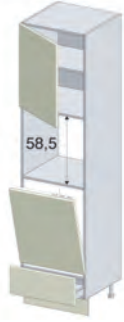
N.B.: cassetti e cestoni ad estrazione totale con blumotion Note: fully extending drawers and deep drawers with blumotion system		COD.	MELAMI-NICO K36	LACCATO OPACO K37					
 <p>*colonna per forno e micro apertura push-pull 1 anta superiore H 48 1 anta inferiore H 48 (cerniere 180°) 1 cestone interno vano micro da H 36,5 a 46,5</p> <p><i>*oven and microwave column</i> push-pull opening 1 upper door H 48 1 lower door H 48 (180° hinges) 1 internal deep drawer microwave compartment H 36,5 to 46,5</p>	L 60	G6551611/2	693	683					
	 <p>*colonna per forno 1 anta superiore H 48 1 anta H 48 sollevamento verticale 1 anta inferiore H 48 (cerniere 180°) 1 cestone interno</p> <p>N.B.: in base alla composizione è obbligatorio inserire nella colonna con anta sollevamento verticale, gola tipo "D" o "C" per permettere l'apertura della stessa</p> <p><i>*oven column</i> 1 upper door H 48 1 door H 48 vertical opening 1 lower door H 48 (180° hinges) 1 internal deep drawer</p> <p>Note: based on the composition, a type "D" or "C" finger rail must be fitted to the column with vertical opening door to allow it to open</p>	L 60	G6554601/2	762	783				
 <p>colonna per forno e lavastoviglie Electrolux TTC 1003 1 anta superiore H 48 1 anta lavastoviglie H 72 1 cassetto H 24</p> <p>N.B.: in base alla composizione è obbligatorio inserire nella colonna con lavastoviglie, gola tipo "D" o "C" per permettere l'apertura della stessa</p> <p><i>column for oven and Electrolux TTC 1003 dishwasher</i> 1 upper door H 48 1 dishwasher door H 72 1 drawer H 24</p> <p>Note: based on the composition, a type "D" or "C" finger rail must be fitted to the column with dishwasher to allow it to open</p>	L 60	G6573601/2	561	570					
	 <p>profilo in acciaio a "L" per rifinire il ripiano del forno e microonde L-shaped steel finishing profile for shelf of oven and microwave</p> 	L 60							
			inox stainless steel	08660100	9	9			
			nero black	08660101	9	9			
			bianco white	08660102	9	9			
 <p>kit protezione fianchi per forno protection kit sides for oven</p> 									
			coppia couple	08630095	16	16			

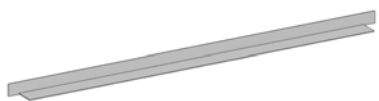

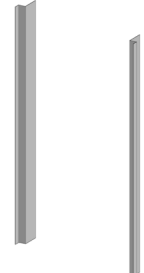

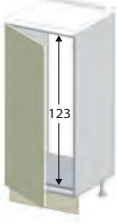
N.B.: cassetti e cestoni ad estrazione totale con blumotion
 Note: fully extending drawers and deep drawers with blumotion system

	COD.	MELAMINICO K36	LACCATO OPACO K37				
 <p>colonna per forno apertura push-pull 1 anta superiore H 96 1 anta inferiore H 72 oven column push-pull opening 1 upper door H 96 1 lower door H 72</p>	L 60	G6540601/2	525	559			
 <p>*colonna per forno apertura push-pull 1 anta superiore H 96 1 anta inferiore H 72 (cerniere 180°) 4 cassetti interni *oven column push-pull opening 1 upper door H 96 1 lower door H 72 (180° hinges) 4 internal drawers</p>	L 60	G6541611/2	783	815			
 <p>*colonna per forno apertura push-pull 1 anta superiore H 96 1 anta inferiore H 72 (cerniere 180°) 2 cassetti interni 1 cestone interno *oven column push-pull opening 1 upper door H 96 1 lower door H 72 (180° hinges) 2 internal drawers 1 internal deep drawer</p>	L 60	G6541621/2	729	762			
 <p>*colonna per forno apertura push-pull 1 anta superiore H 96 1 anta inferiore H 72 (cerniere 180°) 2 cestoni interni *oven column push-pull opening 1 upper door H 96 1 lower door H 72 (180° hinges) 2 internal deep drawers</p>	L 60	G6541631/2	676	709			
<p>NELLE COLONNE PER L'APERTURA DELLE ANTE E' OBBLIGATORIO L'INSERIMENTO DELLE GOLE VERTICALI VERTICAL FINGER RAILS MUST BE FITTED TO COLUMNS WITH OPENING DOORS</p>							
<p>*LE COLONNE CON CASSETTI E CESTONI INTERNI VANNO SEMPRE POSIZIONATE A 5 CM DALLA PARETE LATERALE *COLUMNS WITH INTERNAL DRAWERS AND DEEP DRAWERS SHOULD ALWAYS BE PLACED 5 CM FROM THE SIDE WALL</p>							

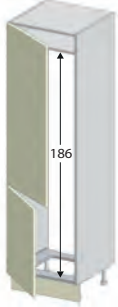
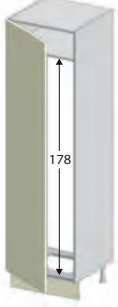
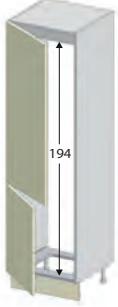
N.B.: cassetti e cestoni ad estrazione totale con blumotion Note: fully extending drawers and deep drawers with blumotion system		COD.	MELAMI- NICO K36	LACCATO OPACO K37				
 <p>*colonna per forno e micro apertura push-pull 1 anta superiore H 72 1 anta inferiore H 48 (cerniere 180°) 1 cestone interno vano micro da H 36,5 a 46,5 *oven and microwave column push-pull opening 1 upper door H 72 1 lower door H 48 (180° hinges) 1 internal deep drawer microwave compartment H 36,5 to 46,5</p>	L 60	G6561611/2	721	719				
 <p>*colonna per forno 1 anta superiore H 72 1 anta H 48 sollevamento verticale 1 anta inferiore H 48 (cerniere 180°) 1 cestone interno N.B.: in base alla composizione è obbligatorio inserire nella colonna con anta sollevamento verticale, gola tipo "D" per permettere l'apertura della stessa *oven column 1 upper door H 72 1 door H 48 vertical opening 1 lower door H 48 (180° hinges) 1 internal deep drawer Note: based on the composition, a type "D" finger rail must be fitted to the column with vertical opening door to allow it to open</p>	L 60	G6564601/2	776	804				
 <p>colonna per forno e lavastoviglie Electrolux TTC 1003 1 anta superiore H 72 1 anta lavastoviglie H 72 1 cassetto H 24 N.B.: in base alla composizione è obbligatorio inserire nella colonna con lavastoviglie, gola tipo "D" per permettere l'apertura della stessa column for oven and Electrolux TTC 1003 dishwasher 1 upper door H 72 1 dishwasher door H 72 1 drawer H 24 Note: based on the composition, a type "D" finger rail must be fitted to the column with dishwasher to allow it to open</p>	L 60	G6575601/2	595	618				
 <p>profilo in acciaio a "L" per rifinire il ripiano del forno e microonde L-shaped steel finishing profile for shelf of oven and microwave</p> 	L 60							
	inox stainless steel	08660100	9	9				
	nero black	08660101	9	9				
	bianco white	08660102	9	9				
 <p>kit protezione fianchi per forno protection kit sides for oven</p> 	coppia couple	08630095	16	16				



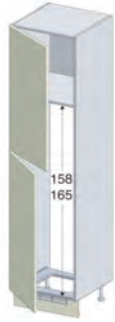



<p>Le colonne non sono comprensive di top The columns do not include the tops</p>	COD.	MELAMINICO K36	LACCATO OPACO K37						
 <p>colonna H 145 per frigo 215 monoporta column H 145 for single-door fridge 215</p>	L 60	G6452151/2	352	378					
 <p>colonna H 217 per frigo 215 monoporta 1 anta superiore H 72 1 anta inferiore H 132 column H 217 for 215 single-door fridge 1 upper door H 72 lower door H 132</p>	L 60	G6462151/2	525	495					
 <p>colonna H 217 per frigo-freezer 230 1 anta superiore H 84 1 anta inferiore H 120 column H 217 for 230 fridge-freezer 1 upper door H 84 1 lower door H 120</p>	L 60	G6462311/2	525	495					
 <p>colonna H 217 per frigo-freezer 280 1 anta superiore H 84 1 anta inferiore H 120 column H 217 for 280 fridge-freezer 1 upper door H 84 1 lower door H 120</p>	L 60	G6462861/2	525	495					
 <p>colonna H 217 per frigo-congelatore 315 1 anta superiore H 132 1 anta inferiore H 72 column H 217 for 315 fridge-freezer 1 upper door H 132 1 lower door H 72</p>	L 60	G6463151/2	525	495					
<p>NELLE COLONNE PER L'APERTURA DELLE ANTE E' OBBLIGATORIO L'INSERIMENTO DELLE GOLE VERTICALI VERTICAL FINGER RAILS MUST BE FITTED TO COLUMNS WITH OPENING DOORS</p>									









	COD.	MELAMI-NICO K36	LACCATO OPACO K37					
 <p>colonna H 217 per frigo-congelatore 315 3 ante anta superiore H 24 anta centrale H 108 anta inferiore H 72 column H 217 for 315 fridge-freezer 3 doors upper door H 24 central door H 108 lower door H 72</p>	L 60	G6463161/2	556	539				
 <p>colonna H 217 per frigo-congelatore 330 1 anta superiore H 132 1 anta inferiore H 72 column H 217 for 330 fridge-freezer 1 upper door H 132 1 lower door H 72</p>	L 60	G6463301/2	525	495				
 <p>colonna H 217 per frigo-freezer 300 monoporta 1 anta H 204 column H 217 for 300 single-door fridge-freezer 1 door H 204</p>	L 60	G6463001/2	525	495				
 <p>colonna H 217 per frigo-congelatore 350 1 anta superiore H 132 1 anta inferiore H 72 column H 217 for 350 fridge-freezer 1 upper door H 132 1 lower door H 72</p>	L 60	G6463501/2	525	495				
		Whirlpool - Hotpoint						
<p>NELLE COLONNE PER L'APERTURA DELLE ANTE E' OBBLIGATORIO L'INSERIMENTO DELLE GOLE VERTICALI VERTICAL FINGER RAILS MUST BE FITTED TO COLUMNS WITH OPENING DOORS</p>								





	COD.	MELAMINICO K36	LACCATO OPACO K37					
 <p>colonna H 241 per frigo 215 monoporta 1 anta superiore H 96 1 anta inferiore H 132 column H 241 for 215 single-door fridge 1 upper door H 96 1 lower door H 132</p>	L 60	G6472151/2	560	553				
 <p>colonna H 241 per frigo-freezer 230 1 anta superiore H 108 1 anta inferiore H 120 column H 241 for 230 fridge-freezer 1 upper door H 108 1 lower door H 120</p>	L 60	G6472311/2	560	553				
 <p>colonna H 241 per frigo-freezer 280 1 anta superiore H 108 1 anta inferiore H 120 column H 241 for 280 fridge-freezer 1 upper door H 108 1 lower door H 120</p>	L 60	G6472861/2	560	553				
 <p>colonna H 241 per frigo-congelatore 315 1 anta superiore H 156 1 anta inferiore H 72 column H 241 for 315 fridge-freezer 1 upper door H 156 1 lower door H 72</p>	L 60	G6473151/2	560	553				
<p>NELLE COLONNE PER L'APERTURA DELLE ANTE E' OBBLIGATORIO L'INSERIMENTO DELLE GOLE VERTICALI VERTICAL FINGER RAILS MUST BE FITTED TO COLUMNS WITH OPENING DOORS</p>								



N.B.: cerniere ammortizzate di serie
 Note: standard blumotion hinges

		COD.	MELAMI- NICO K33	LACCATO OPACO K34				
 <p>1 anta H 36 1 door H 36</p>	L 45	E2030451/2	130	142				
	L 60	E2030601/2	143	150				
	L 65	E2030651/2	148	157				
 <p>1 anta H 48 1 door H 48</p>	L 45	E2040451/2	144	150				
	L 60	E2040601/2	162	168				
	L 65	E2040651/2	168	175				
 <p>1 anta H 60 1 door H 60</p>	L 45	E2060451/2	159	162				
	L 60	E2060601/2	175	184				
 <p>1 anta H 72 1 door H 72</p>	L 15	E2010151/2	133	122				
	L 30	E2010301/2	150	147				
	L 40	E2010401/2	160	164				
	L 45	E2010451/2	165	171				
	L 60	E2010601/2	182	196				
	L 65	E2010651/2	193	224				
 <p>1 anta H 96 1 door H 96</p>	L 15	E2020151/2	155	148				
	L 30	E2020301/2	180	173				
	L 40	E2020401/2	194	197				
	L 45	E2020451/2	202	206				
	L 60	E2020601/2	229	247				
	L 65	E2020651/2	236	263				
 <p>1 anta H 120 1 door H 120</p>	L 30	E2145301/2	254	251				
	L 45	E2145451/2	276	286				
	L 60	E2145601/2	313	340				
 <p>1 anta H 132 1 door H 132</p>	L 30	E2141301/2	263	254				
	L 45	E2141451/2	295	304				

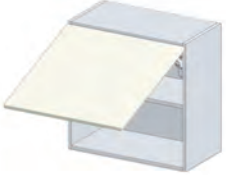

N.B.: cerniere ammortizzate di serie Note: standard blumotion hinges		COD.	MELAMI- NICO	LACCATO OPACO					
			K33	K34					
 <p>angolo H 72 1 anta diagonale corner unit H 72 1 diagonal door</p>	65X65	E2400651/2	236	241					
		 <p>angolo H 96 1 anta diagonale corner unit H 96 1 diagonal door</p>	65X65	E2410651/2	284	288			
 <p>angolo H 72 2 ante a libretto N.B.: fuori squadra realizzabili da 88° a 92° corner unit H 72 2 folding doors Note: out-of-plumb units available from 88° to 92°</p>	65X65			E2450651/2	337	352			
		 <p>angolo H 96 2 ante a libretto N.B.: fuori squadra realizzabili da 88° a 92° corner unit H 96 2 folding doors Note: out-of-plumb units available from 88° to 92°</p>	65X65	E2460651/2	417	412			
 <p>copriboiler H 72 1 anta boiler housing H 72 1 door</p>	L 60 P 33,2 L 60 P 47,2 L 60 P 59,7			E2150601/2	176	190			
		E2160601/2	225	240					
		E2170601/2	225	240					
 <p>copriboiler H 96 1 anta boiler housing H 96 1 door</p>	L 60 P 33,4 L 60 P 47,4 L 60 P 59,9	E2210601/2	210	230					
		E2220601/2	271	294					
		E2230601/2	271	294					
 <p>jolly pensile H 72 L da 10 a 30 jolly wall unit H 72 size from 10 to 30</p>									
		colore come struttura same colour as carcass	G2700000	53	53				
		melaminico come anta melamine same as door	G2700030	160	—				
		laccato come anta lacquered same as door	G2740000	—	321				
 <p>jolly pensile H 96 L da 10 a 30 jolly wall unit H 96 size from 10 to 30</p>									
		colore come struttura same colour as carcass	G2710000	61	61				
		melaminico come anta melamine same as door	G2710030	199	—				
		laccato come anta lacquered same as door	G2750000	—	408				





	COD.	MELAMINICO K33	LACCATO OPACO K34					
<p>anta ribalta H 36 flap door H 36</p> 	L 45	E2100450	155	167				
	L 60	E2100600	163	170				
	L 65	E2100650	175	184				
	L 90	E2100900	205	204				
<p>anta ribalta H 48 flap door H 48</p> 	L 45	E2120450	170	176				
	L 60	E2120600	194	201				
	L 65	E2120650	207	215				
	L 90	E2120900	233	239				
<p>anta ribalta H 60 flap door H 60</p> 	L 60	E212560C	239	248				
	L 90	E212590C	304	319				
<p>pensile H 72 2 ante ribalta H 36 wall unit H 72 2 flap doors H 36</p> 	L 45	EP213450	288	314				
	L 60	EP213600	306	320				
	L 65	EP213650	313	330				
	L 90	EP213900	383	381				
<p>pensile H 96 2 ante ribalta H 48 wall unit H 96 2 flap doors H 48</p> 	L 45	EP223450	323	336				
	L 60	EP223600	368	382				
	L 65	EP223650	377	392				
	L 90	EP223900	442	453				

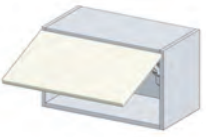

Grazie al meccanismo TIP-ON, le ante a ribalta senza maniglia possono essere aperte semplicemente con un leggero tocco. Per chiudere l'anta a ribalta, è sufficiente esercitare una leggera pressione, che grazie ad una piastrina di bloccaggio, applicata sul lato interno del frontale, ne assicura la perfetta chiusura.

Thanks to TIP-ON mechanism, the flap doors without handles can be opened with a simple touch. To close the flap door, just exercise light pressure, thanks to the locking plate, applied on the inner side of the front panel ensures a perfect closure.

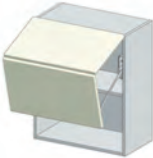
		COD.	MELAMINICO K33	LACCATO OPACO K34				
 <p>anta ribalta TIP-ON H 36 flap door TIP-ON H 36</p>	L 45	E210046T	165	177				
	L 60	E210061T	173	179				
	L 65	E210066T	185	194				
	L 90	E210091T	215	214				
 <p>anta ribalta TIP-ON H 48 flap door TIP-ON H 48</p>	L 45	E212046T	176	182				
	L 60	E212061T	202	208				
	L 65	E212066T	215	223				
	L 90	E212091T	241	247				
 <p>anta ribalta TIP-ON H 60 flap door TIP-ON H 60</p>	L 60	E212561T	250	259				
	L 90	E212591T	316	329				

		COD.	MELAMI- NICO K33	LACCATO OPACO K34					
 <p>anta apertura verticale obliqua H 60 door with oblique vertical opening H 60</p>	L 60	E2135600	280	290					
	L 90	E2135900	328	343					
 <p>anta apertura verticale obliqua H 72 door with oblique vertical opening H 72</p>	L 60	E2130600	293	307					
	L 90	E2130900	340	366					
 <p>pensile H 72 apertura a pacchetto 2 ante H 36 wall unit H 72 lift-up folding door 2 doors H 36</p>	L 45	E2070450	341	366					
	L 60	E2070600	366	380					
	L 65	E2070650	373	390					
	L 90	E2070900	424	422					
 <p>pensile H 96 apertura a pacchetto 2 ante H 48 wall unit H 96 lift-up folding door 2 doors H 48</p>	L 45	E2090450	370	382					
	L 60	E2090600	401	415					
	L 65	E2090650	409	425					
	L 90	E2090900	476	488					

N.B.: cerniere ammortizzate di serie
 Note: standard blumotion hinges

COD.

MELAMI-
NICO
K33

LACCATO
OPACO
K34



pensile H 72
1 anta ribalta H 36
vano per micro Whirlpool
 wall unit H 72
 1 flap door H 36
 housing for Whirlpool microwave



L 60

EPM20600

195

198

pensile H 96
1 anta H 60
vano per micro Whirlpool
 wall unit H 96
 1 door H 60
 housing for Whirlpool microwave

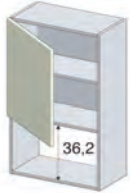





L 60





EPM25601/2





207





217



N.B.: cerniere ammortizzate di serie
 Note: standard blumotion hinges

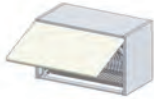
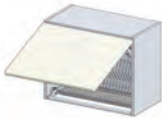

		COD.	MELAMINICO K33	LACCATO OPACO K34				
 <p>soprapensile H 36 1 anta top unit H 36 1 door</p>	L 45	E2063451/2	182	196				
	L 60	E2063601/2	184	202				
 <p>soprapensile H 48 1 anta top unit H 48 1 door</p>	L 45	E2064451/2	218	226				
	L 60	E2064601/2	226	233				
 <p>soprapensile H 60 1 anta top unit H 60 1 door</p>	L 45	E2065451/2	227	232				
	L 60	E2065601/2	233	244				
 <p>soprapensile H 36 2 ante top unit H 36 2 doors</p>	L 90	E2063900	276	302				
	L 90	E2064900	324	337				
 <p>soprapensile H 48 2 ante top unit H 48 2 doors</p>	L 90	E2065900	343	350				
	L 90	E2065900	343	350				

gli scolapiatti sono realizzabili anche con apertura senza maniglia con presa sul fondo (opz.997) plate-rack units are feasible also without handle, grip on bottom opening (opt. 997)		COD.	MELAMI- NICO K33	LACCATO OPACO K34					
 <p>1 anta H 60 1 door H 60</p>	L 60	E3060601/2	194	204					
			mag.griglie con luce led surcharge grilles with led light	+84	+84				
	 <p>1 anta H 72 1 door H 72</p>	L 45	E3010451/2	186	191				
L 60		E3010601/2	201	215					
L 65		E3010651/2	235	266					
		mag.griglie con luce led surcharge grilles with led light	+84	+84					
 <p>1 anta H 96 1 door H 96</p>	L 45	E3020451/2	223	226					
	L 60	E3020601/2	252	271					
	L 65	E3020651/2	278	304					
			mag.griglie con luce led surcharge grilles with led light	+84	+84				
 <p>1 anta H 120 1 door H 120</p>	L 45	E3067451/2	291	301					
	L 60	E3067601/2	323	351					
			mag.griglie con luce led surcharge grilles with led light	+84	+84				

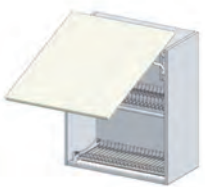
<p>gli scolapiatti sono realizzabili anche con apertura senza maniglia con presa sul fondo (opz.997) plate-rack units are feasible also without handle, grip on bottom opening (opt. 997)</p>	COD.	MELAMINICO K33	LACCATO OPACO K34					
<p>2 ante H 60 2 doors H 60</p> 	L 90 E3060900	308	314					
<p>mag.griglie con luce led surcharge grilles with led light</p>		+84	+84					
<p>2 ante H 72 2 doors H 72</p> 	L 80 E3010800	312	321					
<p>L 90 E3010900</p> <p>mag.griglie con luce led surcharge grilles with led light</p>		324	334					
<p>mag.griglie con luce led surcharge grilles with led light</p>		+84	+84					
<p>2 ante H 96 2 doors H 96</p> 	L 80 E3020800	368	376					
<p>L 90 E3020900</p> <p>mag.griglie con luce led surcharge grilles with led light</p>		387	394					
<p>mag.griglie con luce led surcharge grilles with led light</p>		+84	+84					
<p>angolo H 72 2 ante a libretto N.B.: non si effettuano fuori squadra corner unit H 72 2 folding doors Note: out-of-plumb units unavailable</p> 	65X65 E3450651/2	487	510					
<p>angolo H 96 2 ante a libretto N.B.: non si effettuano fuori squadra corner unit H 96 2 folding doors Note: out-of-plumb units unavailable</p> 	65X65 E3460651/2	573	568					

	COD.	MELAMI- NICO K33	LACCATO OPACO K34					
<p>anta ribalta H 36 flap door H 36</p> 								
	L 60	E3100600	178	191				
	L 90	E3100900	225	225				
			+84	+84				
mag.griglie con luce led surcharge grilles with led light								
<p>anta ribalta H 48 flap door H 48</p> 								
	L 60	E3120600	199	206				
	L 90	E3120900	241	247				
			+84	+84				
mag.griglie con luce led surcharge grilles with led light								
<p>anta ribalta H 60 flap door H 60</p> 								
	L 60	E312260C	249	259				
	L 90	E312290C	318	333				
			+84	+84				
mag.griglie con luce led surcharge grilles with led light								
<p>scolapiatti H 72 2 ante ribalta H 36 plate rack unit H 72 2 flap doors H 36</p> 								
	L 60	EP313600	325	340				
	L 90	EP313900	409	408				
			+84	+84				
mag.griglie con luce led surcharge grilles with led light								
<p>scolapiatti H 96 2 ante ribalta H 48 plate rack unit H 96 2 flap doors H 48</p> 								
	L 60	EP323600	371	385				
	L 90	EP323900	447	460				
			+84	+84				
mag.griglie con luce led surcharge grilles with led light								

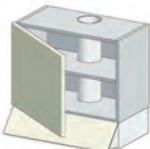
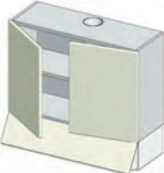

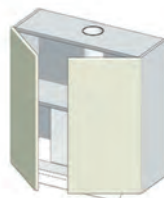



	COD.	MELAMINICO K33	LACCATO OPACO K34					
<p>anta apertura verticale obliqua H 60 door with vertical oblique opening H 60</p> 	L 60	E3123600	292	302				
	L 90	E3123900	343	358				
			+84	+84				
mag.griglie con luce led surcharge grilles with led light								
<p>anta apertura verticale obliqua H 72 door with vertical oblique opening H 72</p> 	L 60	E3125600	304	318				
	L 90	E3125900	353	380				
			+84	+84				
mag.griglie con luce led surcharge grilles with led light								
<p>scolapiatti H 72 apertura a pacchetto 2 ante H 36 plate rack unit H 72 lift-up folding door 2 doors H 36</p> 	L 60	E3081600	377	394				
	L 90	E3081900	438	436				
			+84	+84				
mag.griglie con luce led surcharge grilles with led light								
<p>scolapiatti H 96 apertura a pacchetto 2 ante H 48 plate rack unit H 96 lift-up folding door 2 doors H 48</p> 	L 60	E3094600	413	426				
	L 90	E3094900	490	502				
			+84	+84				
mag.griglie con luce led surcharge grilles with led light								

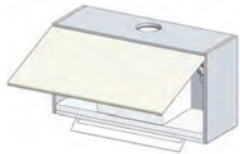
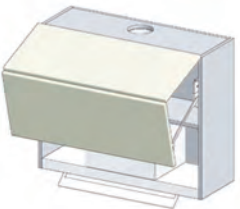
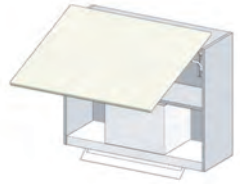
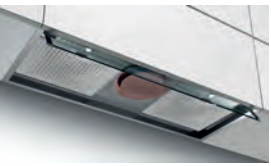





N.B.: cerniere ammortizzate di serie Note: standard blumotion hinges		COD.	MELAMI- NICO K33	LACCATO OPACO K34				
	cappa estraibile 2 motori portata 275 m³/h con laterali in metallo, 1 anta							
	N.B.: posizionare la cappa ad una distanza non inferiore ai 65 cm dal piano cottura							
	slide-out hood 2 motors air flow rate 275 m³/h with metal sides, 1 door Note: position the hood at least 65 cm from the cooker hob							
	H 63 L 60 H 87 L 60 n° 2 filtri carbone attivo 2 active carbon filters	E3600601/2 E3610601/2 +24	324 347 +24	348 378 +24				
	cappa estraibile 2 motori portata 275 m³/h con laterali in metallo, 2 ante							
	N.B.: posizionare la cappa ad una distanza non inferiore ai 65 cm dal piano cottura							
	slide-out hood 2 motors air flow rate 275 m³/h with metal sides, 2 doors Note: position the hood at least 65 cm from the cooker hob							
	H 63 L 90 H 87 L 90 n° 2 filtri carbone attivo 2 active carbon filters	E3600900 E3610900 +24	438 480 +24	466 506 +24				
	cappa "Mod. F" integrata totale con frontalino vetro estraibile portata 415 m³/h con faretti a led 1 anta							
	N.B.: posizionare la cappa ad una distanza non inferiore ai 55 cm dal piano cottura							
	N.B.: realizzabile anche con apertura senza maniglia presa sul fondo (opz.997)							
	"Mod. F" fully integrated hood with glass pull-out frontal panel air flow rate 415 m³/h, with led lights 1 door Note: position the hood at least 55 cm from the cooker hob Note: feasible even with grip on bottom opening (opz.997)	H 60 L 60 H 72 L 60 H 96 L 60 n° 2 filtri carbone attivo 2 active carbon filters	EPC90461/2 EPC90561/2 EPC90661/2 08750894	529 540 585 +28	536 551 602 +28			
	cappa "Mod. F" integrata totale con frontalino vetro estraibile portata 415 m³/h con faretti a led 2 ante							
	N.B.: posizionare la cappa ad una distanza non inferiore ai 55 cm dal piano cottura							
	N.B.: realizzabile anche con apertura senza maniglia presa sul fondo (opz.997)							
	"Mod. F" fully integrated hood with glass pull-out front panel air flow rate 415 m³/h with led lights 2 doors Note: position the hood at least 55 cm from the cooker hob Note: feasible even with grip on bottom opening (opz.997)	H 60 L 90 H 72 L 90 H 96 L 90 n° 2 filtri carbone attivo 2 active carbon filters	EPC90490 EPC90590 EPC90690 08750894	658 676 738 +28	662 684 743 +28			

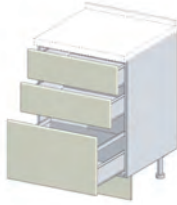

N.B.: cerniere ammortizzate di serie

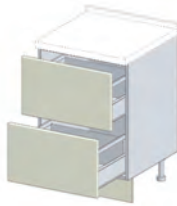
Note: standard blumotion hinges

	COD.	MELAMINICO K33	LACCATO OPACO K34					
 <p>cappa "Mod. F" integrata totale con frontalino vetro estraibile portata 415 m³/h con faretti a led 1 anta apertura a ribalta N.B.: posizionare la cappa ad una distanza non inferiore ai 55 cm dal piano cottura N.B.: realizzabile anche con apertura senza maniglia presa sul fondo (opz.997)</p> <p>"Mod. F" fully integrated hood with glass pull-out front panel air flow rate 415 m³/h with led lights 1 flap door Note: position the hood at least 55 cm from the cooker hob Note: feasible even with grip on bottom opening (opz.997)</p>	H 36 L 60	EPC80260	524	528				
	H 36 L 90	EPC80290	590	588				
	H 48 L 60	EPC80360	550	555				
	H 48 L 90	EPC80390	628	631				
	H 60 L 60	EPC80460	676	687				
	H 60 L 90	EPC80490	777	792				
	n° 2 filtri carbone attivo 2 active carbon filters	08750894	+28	+28				
	 <p>cappa "Mod. F" integrata totale con frontalino vetro estraibile portata 415 m³/h con faretti a led 2 ante apertura a pacchetto N.B.: posizionare la cappa ad una distanza non inferiore ai 55 cm dal piano cottura N.B.: realizzabile anche con apertura senza maniglia presa sul fondo (opz.997)</p> <p>"Mod. F" fully integrated hood with glass pull-out front panel air flow rate 415 m³/h with led lights 2 lift-up folding doors Note: position the hood at least 55 cm from the cooker hob Note: feasible even with grip on bottom opening (opz.997)</p>	H 72 L 60	EPC83560	717	729			
H 72 L 90		EPC83590	799	796				
H 96 L 60		EPC83660	756	766				
H 96 L 90		EPC83690	854	864				
n° 2 filtri carbone attivo 2 active carbon filters		08750894	+28	+28				
 <p>cappa "Mod. F" integrata totale con frontalino vetro estraibile portata 450 m³/h 1 anta apertura verticale obliqua N.B.: posizionare la cappa ad una distanza non inferiore ai 55 cm dal piano cottura N.B.: realizzabile anche con apertura senza maniglia presa sul fondo (opz.997)</p> <p>"Mod. F" fully-integrated hood with glass pull-out front panel flow rate 415 m³/h with led lights 1 door with vertical oblique opening Note: position the hood at least 55 cm from the cooker hob Note: feasible even with grip on bottom opening (opz.997)</p>		H 60 L 60	EPC86460	642	650			
	H 60 L 90	EPC86490	715	728				
	H 72 L 60	EPC86560	658	670				
	H 72 L 90	EPC86590	729	753				
	n° 2 filtri carbone attivo 2 active carbon filters	08750894	+28	+28				
	<p>Maggiorazione cappa "ILMA" incasso pensile consigliata per piano cottura ad induzione</p> <p>Surcharge "ILMA" built in hood recommended for induction cooker hob</p> 	L 60	opz.003	+691	+691			
L 90		opz.003	+720	+720				
filtra carbone attivo active carbon filter		08750889	+71	+71				

Le basi non sono comprensive di top - N.B.: cerniere ammortizzate di serie The base units do not include the tops - Note: standard blumotion hinges		COD.	MELAMINICO K33	LACCATO OPACO K34				
 <p>fascia tamponamento N.B.: da L 3 a 5 è realizzata in massello liscio, superiore a L 5 è realizzata con cornice come anta filler panel Note: realized in smooth solid wood from W 3 to 5, up to W 5 realized with frame as door</p>	L da 3 a 10 size from 3 to 10	E4800000	115	132				
 <p>jolly base L da 10 a 30 jolly base unit size from 10 to 30</p>								
	colore come struttura same colour as carcass	E4700000	75	75				
	melaminico come anta melamine same as door	E4700030	200	—				
	laccato come anta lacquered same as door	E4720000	—	390				
 <p>1 anta 1 door</p>	L 15	E4010151/2	157	145				
	L 30	E4010301/2	171	168				
	L 40	E4010401/2	182	186				
	L 45	E4010451/2	190	195				
	L 60	E4010601/2	210	224				
	L 65	E4010651/2	223	254				
 <p>2 ante 2 doors</p>	L 60	E4010600	291	285				
	L 80	E4010800	316	325				
	L 90	E4010900	331	342				
 <p>cestello estraibile chiusura soft pull-out basket unit soft-closing system</p>	L 15	E4150150	185	173				
	L 30	E4150300	232	229				
	L 45	E4150450	253	258				
 <p>4 cassetti H 18 4 drawers H 18</p>	L 30	E4101300	455	459				
	L 40	E4101400	511	466				
	L 45	E4101450	495	489				
	L 60	E4101600	564	524				

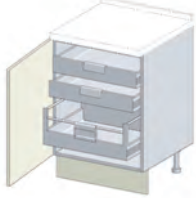
Le basi non sono comprensive di top - N.B.: cassetti e cestoni ad estrazione totale con blumotion The base units do not include the tops - Note: fully extending drawers and deep drawers with blumotion system		COD.	MELAMI- NICO	LACCATO OPACO					
			K33	K34					
 <p>2 cassetti H 18 1 cestone H 36 2 drawers H 18 1 deep drawer H 36</p>	L 45	E4131450	419	432					
	L 60	E4131600	467	451					
	L 90	E4131900	556	532					
 <p>4 cassetti H 18 1 cestone H 36 4 drawers H 18 1 deep drawer H 36</p>	L 90	E4300900	752	746					
	 <p>2 cestoni H 36 2 deep drawers H 36</p>	L 45	E4171450	342	374				
L 60		E4171600	376	384					
L 90		E4171900	452	452					
 <p>1 cassetto H 12 1 anta H 60 1 drawer H 12 1 door H 60</p>	L 45	E4021451/2	291	292					
	L 60	E4021601/2	324	322					
	L 90	E4021900	458	444					
 <p>1 cassetto H 12 2 ante H 60 1 drawer H 12 2 doors H 60</p>	L 30	08700030X	10	10					
	L 40	08700040X	10	10					
	L 45	08700050X	10	10					
	L 60	08700060X	11	11					
	L 90	08700070X	32	32					
 <p>portaposate in plastica per cassetti plastic cutlery tray for drawers</p>	divisori regolabili L 90 adjustable separators								

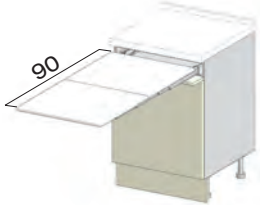
Le basi non sono comprensive di top - N.B.: cassetti e cestoni ad estrazione totale con blumotion The base units do not include the tops - Note: fully extending drawers and deep drawers with blumotion system		COD.	MELAMI- NICO K33	LACCATO OPACO K34				
 <p>1 anta 2 cassetti interni 1 cestone interno posizionare a 5 cm dalla parete laterale 1 door 2 internal drawers 1 internal deep drawer place at 5 cm from the side wall</p>	L 45	E4236461/2	391	397				
	L 60	E4236611/2	424	437				
 <p>1 anta 2 cestoni interni posizionare a 5 cm dalla parete laterale 1 door 2 internal deep drawers place at 5 cm from the side wall</p>	L 45	E4236471/2	339	345				
	L 60	E4236621/2	370	384				
 <p>base tavolo estraibile LUNCH portata 60 kg 1 anta H 60 1 frontale H 12 base unit with pull-out table LUNCH load capacity kg 60 1 door H 60 1 front H 12</p>	L 60	E4230601/2	716	714				
	L 90	E4230900	846	832				

BASI ANGOLO

CORNER BASE UNITS

H 85 P 65

Le basi non sono comprensive di top - N.B.: cerniere ammortizzate di serie
 The base units do not include the tops - Note: standard blumotion hinges

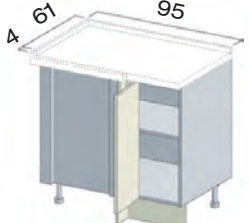
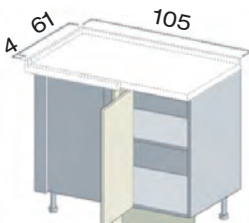
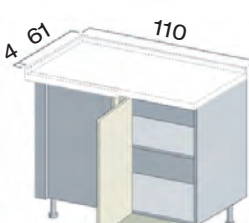
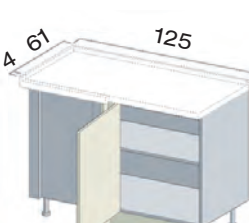
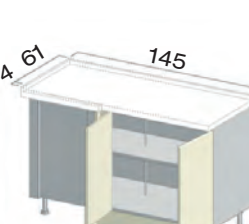
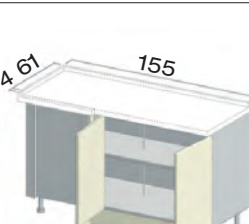
	COD.	MELAMI- NICO K33	LACCATO OPACO K34				
 <p>angolo L 95 1 ripiano 1 anta L 30 (cerniere a pilastro) cassone 90 corner unit W 95 1 shelf 1 door W 30 (pillar hinges) structure 90</p> <p>verso dx RH version</p>	95x65	E4400951/2	344	356			
 <p>angolo L 105 1 ripiano 1 anta L 40 (cerniere a pilastro) cassone 90 corner unit W 105 1 shelf 1 door W 40 (pillar hinges) structure 90</p> <p>verso dx RH version</p>	105x65	E4401041/2	350	369			
 <p>angolo L 110 1 ripiano 1 anta L 45 (cerniere a pilastro) cassone 105 corner unit W 110 1 shelf 1 door W 45 (pillar hinges) structure 105</p> <p>verso dx RH version</p>	110x65	E4401091/2	369	389			
 <p>angolo L 125 1 ripiano 1 anta L 60 (cerniere a pilastro) cassone 120 corner unit W 125 1 shelf 1 door W 60 (pillar hinges) structure 120</p> <p>verso dx RH version</p>	125x65	E4401241/2	389	417			
 <p>angolo L 145 1 ripiano 2 ante L 40 cassone 140 con tirante corner unit W 145 1 shelf 2 doors W 40 structure 140 with tie beam</p> <p>verso dx RH version</p>	145x65	E4401451/2	512	535			
 <p>angolo L 155 1 ripiano 2 ante L 45 cassone 150 con tirante corner unit W 155 1 shelf 2 doors W 45 structure 150 with tie beam</p> <p>verso dx RH version</p>	155x65	E4401551/2	522	548			

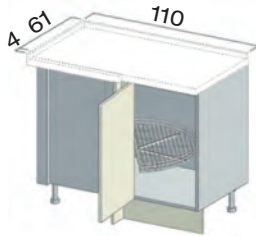
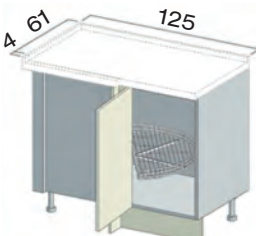
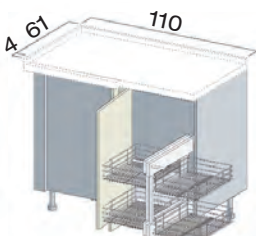
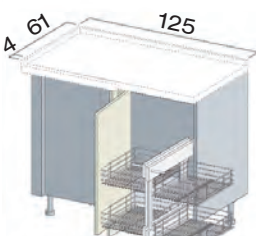
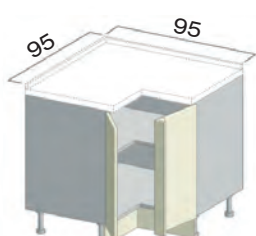
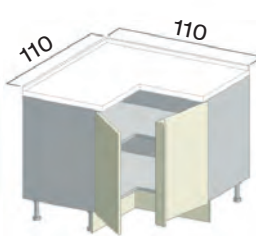
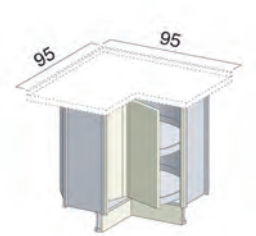
Le basi non sono comprensive di top - N.B.: cerniere ammortizzate di serie The base units do not include the tops - Note: standard blumotion hinges		COD.	MELAMI-NICO K33	LACCATO OPACO K34				
 <p>angolo L 110 cestello mezzaluna 1 anta L 45 (cerniere a pilastro) cassone 105 corner unit W 110 crescent-shaped wire basket unit 1 door W 45 (pillar hinges) structure 105</p> <p>verso dx RH version</p>	<p>1 cestello 110x65 1 basket drawer</p>	E4401101/2	369	389				
	<p>2 cestelli 110x65 2 basket drawers</p>	E4401111/2	396	416				
 <p>angolo L 125 cestello mezzaluna 1 anta L 60 (cerniere a pilastro) cassone 120 corner unit W 125 crescent-shaped wire basket unit 1 door W 60 (pillar hinges) structure 120</p> <p>verso dx RH version</p>	<p>1 cestello 125x65 1 basket unit</p>	E4401251/2	389	417				
	<p>2 cestelli 125x65 2 basket units</p>	E4401261/2	415	443				
 <p>angolo L 110 4 cestelli estraibili indipendenti dall'anta 1 anta L 45 (cerniere a pilastro) cassone 105 corner unit W 110 4 pull-out basket unit opening independently from door 1 door W 45 (pillar hinges) structure 105</p> <p>verso dx RH version</p>	<p>110x65</p>	E4451101/2	860	899				
 <p>angolo L 125 4 cestelli estraibili indipendenti dall'anta 1 anta L 60 (cerniere a pilastro) cassone 120 corner unit W 125 4 pull-out basket units opening independently from door 1 door W 60 (pillar hinges) structure 120</p> <p>verso dx RH version</p>	<p>125x65</p>	E4451251/2	923	977				
 <p>angolo 95x95 1 ripiano 2 ante L 30 (cerniere 180°) angolare unito all'anta dx corner unit 95x95 1 shelf 2 doors W 30 (180° hinges) angular filler attached to the RH door</p>	<p>95x95</p>	E4481950	727	737				
 <p>angolo 110x110 1 ripiano 2 ante L 45 (cerniere 180°) angolare unito all'anta dx corner unit 110x110 1 shelf 2 doors W 45 (180° hinges) angular filler attached to the RH door</p>	<p>110x110</p>	E4482100	789	817				
 <p>angolo 95x95 ante girevoli N.B.: non è possibile inserire elettrodomestici corner unit 95x95 swivel doors Note: household appliances cannot be inserted</p>	<p>95x95</p>	E4470950	1.075	1.063				

BASI ANGOLO PANNELLO COME ANTA



H 85 P 61

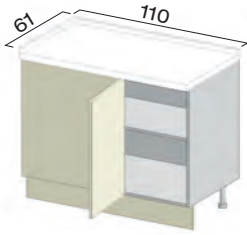
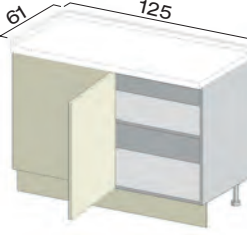
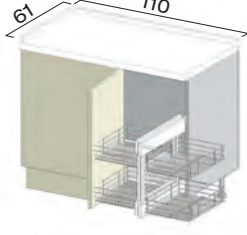
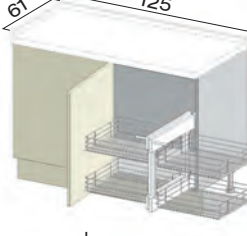
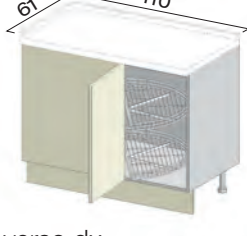
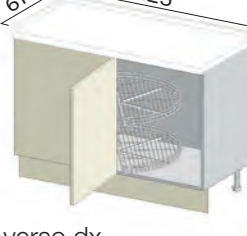

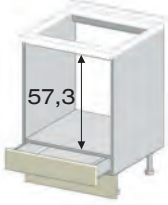
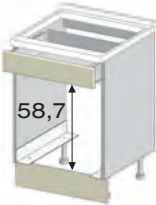
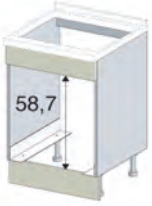
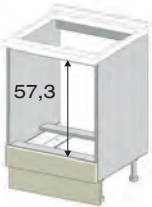
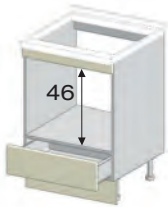
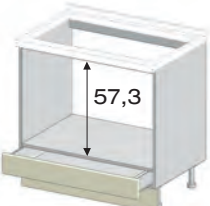
CORNER BASE UNITS PANEL AS DOOR

LE BASI NON SONO COMPRENSIVE DI TOP THE BASE UNITS DO NOT INCLUDE THE TOPS		COD.	MELAMINICO K33	LACCATO OPACO K34				
 <p>angolo L 110 1 ripiano 1 anta L 45 pannello come anta (impiallacciato per la versione melaminico) cassone 110 corner unit W 110 1 shelf 1 door W 45 panel as door (veneered panel for melamine version) structure 110</p> <p>verso dx RH version</p>	110x61	E4403091/2	432	424				
 <p>angolo L 125 1 ripiano 1 anta L 60 pannello come anta (impiallacciato per la versione melaminico) cassone 125 corner unit W 125 1 shelf 1 door W 60 panel as door (veneered panel for melamine version) structure 125</p> <p>verso dx RH version</p>	125x61	E4403241/2	440	440				
 <p>angolo L 110 4 cestelli estraibili indipendenti dall'anta 1 anta L 45 pannello come anta (impiallacciato per la versione melaminico) cassone 110 corner unit W 110 4 pull-out basket units opening independently from door 1 door W 45 panel as door (veneered panel for melamine version) structure 110</p> <p>verso dx RH version</p>	110x61	E4453101/2	962	954				
 <p>angolo L 125 4 cestelli estraibili indipendenti dall'anta 1 anta L 60 pannello come anta (impiallacciato per la versione melaminico) cassone 125 corner unit W 125 4 pull-out basket units opening independently from door 1 door W 60 panel as door (veneered panel for melamine version) structure 125</p> <p>verso dx RH version</p>	125x61	E4453251/2	1.030	1.030				
 <p>angolo L 110 2 cestelli mezzaluna 1 anta L 45 pannello come anta (impiallacciato per la versione melaminico) cassone 110 corner unit W 110 2 crescent-shaped wire basket units 1 door W 45 panel as door (veneered panel for melamine version) structure 110</p> <p>verso dx RH version</p>	110x61	E4403111/2	452	444				
 <p>angolo L 125 2 cestelli mezzaluna 1 anta L 60 pannello come anta (impiallacciato per la versione melaminico) cassone 125 corner unit W 125 2 crescent-shaped wire basket units 1 door W 60 panel as door (veneered panel for melamine version) structure 125</p> <p>verso dx RH version</p>	125x61	E4403261/2	470	470				

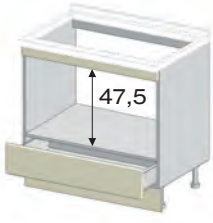

Le basi non sono comprensive di top - N.B.: cassetti ad estrazione totale con blumotion The base units do not include the tops - Note: fully extending drawers with blumotion system		COD.	MELAMI- NICO K33	LACCATO OPACO K34				
 <p>base per forno elettrico H 60 cassetto H 12 inferiore electric oven base unit H 60 lower drawer H 12</p>	L 60	E5510607	233	221				
	 <p>base per forno elettrico H 60 cassetto H 12 superiore electric oven base unit H 60 upper drawer H 12</p>	L 60	E5510608	233	221			
 <p>base per forno elettrico H 60 frontale superiore fisso H 12 N.B.: da utilizzare per top H 2 e per P.C. filo top electric oven base unit H 60 fixed upper front H 12 Note: to be used in conjunction with tops H 2 and flush hobs</p>		L 60	E5510620	170	156			
	 <p>base per forno gas H 60 frontale inferiore fisso H 12 gas oven base unit H 60 fixed lower front H 12</p>	L 60	E5520600	171	159			
 <p>base per forno elettrico H 46 fascia superiore H 8,1 cassetto H 18 electric oven base unit H 46 upper filler H 8,1 drawer H 18</p>		L 60	E5530600	297	302			
	 <p>base per maxiforno H 60 cassetto H 12 maxi-oven base unit H 60 drawer H 12</p>	L 90	E5510907	285	264			

Le basi non sono comprensive di top - N.B.: cassetti ad estrazione totale con blumotion
 The base units do not include the tops - Note: fully extending drawers with blumotion system

	COD.	MELAMI- NICO K33	LACCATO OPACO K34					
 <p>base per maxiforno H 48 fascia superiore H 5,9 cassetto H 18 maxi-oven base unit H 48 upper filler H 5,9 drawer H 18</p>	L 90	E5510920	357	339				
 <p>kit raccordo base angolo junction kit corner base unit</p>	110x110	E5471100	194	203				
 <p>kit raccordo base angolo per inserimento lavastoviglie a destra o sinistra junction kit for corner base unit for dishwasher placed on the right or the left side</p> <p>verso dx RH version</p>	110x110	E5471151/2	227	236				

Le basi non sono comprensive di top - N.B.: cassetti e cestoni ad estrazione totale con blumotion The base units do not include the tops - Note: fully extending drawers and deep drawers with blumotion system		COD.	MELAMI- NICO K33	LACCATO OPACO K34				
 <p>base predisposta piano cottura 1 anta base unit configured for cooker hob 1 door</p>	<p>L 60</p> <p>mag.base piano cottura ad induzione surcharge base unit for induction cooker hob</p>	E5500601/2	210	224				
		opz.101	+55	+55				
 <p>base predisposta piano cottura 2 ante base unit configured for cooker hob 2 doors</p>	<p>L 90</p> <p>mag.base piano cottura ad induzione surcharge base unit for induction cooker hob</p>	E5500900	331	342				
		opz.101	+55	+55				
 <p>Maggiorazione per base predisposta piano cottura ad induzione con lamierino di protezione N.B.: realizzabile su base 2 cassetti+1 cestone, base 2 cestoni e base 4 cassetti Surcharge for base unit configured for induction cooker hob with protection metal sheet Note: available on base unit 2 drawers+1 deep drawer, base unit 2 deep drawers and base unit 4 drawers</p>		opz.101	+55	+55				

Le basi non sono comprensive di top - N.B.: cerniere ammortizzate di serie
 The base units do not include the tops - Note: standard blumotion hinges

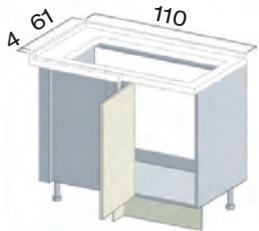
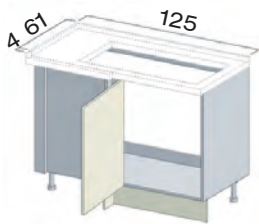
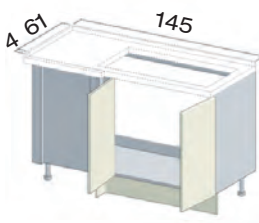
	COD.	MELAMINICO K33	LACCATO OPACO K34					
 <p>sottolavello 1 anta sink base unit 1 door</p>	L 45	E5010451/2	188	197				
	L 60	E5010601/2	206	224				
 <p>sottolavello 2 ante sink base unit 2 doors</p>	L 60	E5010600	285	283				
	L 80	E5010800	311	326				
	L 90	E5010900	321	337				
	L 120	E5011200	363	396				
 <p>sottolavello 2 cestoni H 36 cestone superiore sagomato con vaschette sink base unit 2 deep drawers H 36 contoured upper deep drawer with trays</p>	L 60	E5200600	418	426				
	L 90	E5200900	485	484				
 <p>sottolavello angolo L 110 1 anta L 45 (cerniere pilastro) cassone 105 corner sink base unit W 110 1 door W 45 (pillar hinges) structure 105</p> <p>verso dx RH version</p>	110x65	E4421101/2	343	362				
 <p>sottolavello angolo L 125 1 anta L 60 (cerniere pilastro) cassone 120 corner sink base unit W 125 1 door W 60 (pillar hinges) structure 120</p> <p>verso dx RH version</p>	125x65	E4421251/2	365	393				
 <p>sottolavello angolo L 145 2 ante L 40 (cerniere pilastro) cassone 140 corner sink base unit W 145 2 doors W 40 (pillar hinges) structure 140</p> <p>verso dx RH version</p>	145x65	E4421451/2	464	487				

Le basi non sono comprensive di top - N.B.: cerniere ammortizzate di serie
 The base units do not include the tops - Note: standard blumotion hinges

COD.

MELAMI-
NICO
K33

LACCATO
OPACO
K34

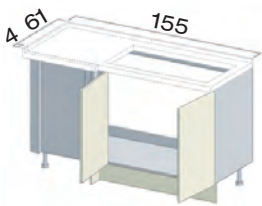

verso dx
RH version

sottolavello angolo L 155
2 ante L 45 (cerniere pilastro)
cassone 150

corner sink base unit W 155
 2 doors W 45 (pillar hinges)
 structure 150

155x65

E4421551/2

477

502

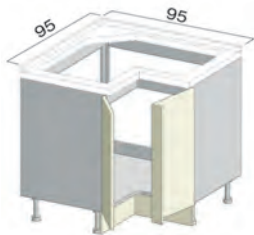

sottolavello angolo 95x95
2 ante L 30 (cerniere 180°)
angolare unito all'anta dx

corner sink base unit 95x95
 2 doors W 30 (180° hinges)
 angular filler attached to the RH door

95x95

E5021950

668

682

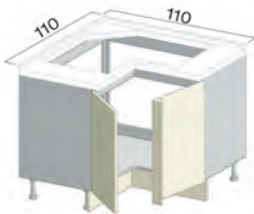

sottolavello angolo 110x110
2 ante L 45 (cerniere 180°)
angolare unito all'anta dx

corner sink base unit 110x110
 2 doors W 45 (180° hinges)
 angular filler attached to the RH door





110x110

E5022100

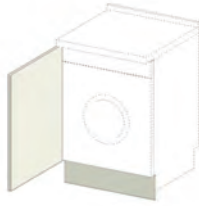



678

696

Le basi non sono comprensive di top The base units do not include the tops		COD.	MELAMINICO K33	LACCATO OPACO K34					
	anta per lavastoviglie scomparsa totale completa di kit protezione fianchi door for fully integrated dishwasher with protection kit for side panels	L 45 L 60	E4490080 E4490090	136 153	128 154				
	anta per lavastoviglie scomparsa totale estetica 2 cestoni completa di kit protezione fianchi door for fully integrated dishwasher 2 deep drawers aesthetic with protection kit for side panels	L 60	E4490100	232	248				
	anta per lavastoviglie comandi a vista completa di kit protezione fianchi door for dishwasher with visible controls with protection kit for side panels	L 45 L 60	E4490050 E4490060	107 123	110 134				
	kit protezione fianchi per lavastoviglie protection kit for side panels for dishwasher								
	anta per lavabiancheria scomparsa totale door for fully integrated washing machine	L 60	E4490011/2	153	154				

Le basi non sono comprensive di top The base units do not include the tops		COD.	MELAMI- NICO K33	LACCATO OPACO K34				
 <p>anta con fianco per frigo e congelatore sottotop door with side panel for under-top fridge and freezer</p>	L 60	E4490151/2	178	179				
	 <p>anta per frigo e congelatore sottotop door for under-top fridge and freezer</p>	L 60	E4490181/2	153	154			
 <p>frontali per frigo a cassettoni fronts for drawer fridge</p>		L 90	E4490900	259	257			
	 <p>fianco per elettrodomestici a fine composizione side panel for appliances placed at the end of the composition</p>							
<p>in nobilitato melamine coated H 85x59,9x1,8 zoccolo H 13 plinth</p>		T94613	25	25				
<p>come anta as door H 85x59,9x1,8 zoccolo H 13 plinth</p>		T94683	133	183				

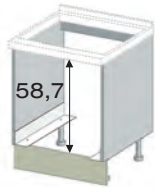
Le basi non sono comprensive di top - N.B.: cerniere ammortizzate di serie
 The base units do not include the tops - Note: standard blumotion hinges

	COD.	MELAMI- NICO K33	LACCATO OPACO K34					
 <p>base H 73 1 anta base unit H 73 1 door</p>	L 45	E4030451/2	189	192				
	L 60	E4030601/2	209	219				
 <p>base H 73 2 ante base unit H 73 2 doors</p>	L 90	E4030900	325	332				
	L 120	E4031200	365	385				
 <p>base H 73 2 cassetti H 18 1 cassetto H 24 base unit H 73 2 drawers H 18 1 drawer H 24</p>	L 45	E4250450	403	397				
	L 60	E4250600	458	433				
	L 90	E4250900	538	514				
 <p>base H 73 predisposta per forno H 60 base unit H 73 configured for oven H 60</p>	L 60	E5540600	115	115				
 <p>base H 73 predisposta per lavastoviglie Electrolux ESL 2450 RO 1 anta H 41,4 1 fascia H 5,9 e 1 cassetto H 12 base unit H 73 configured for Electrolux ESL 2450 RO dishwasher 1 door H 41,4 1 panel H 5,9 and 1 drawer H 12</p>	L 60	E4590600	445	449				

SOTTOLAVELLI H 73

H 73 P 61

SINK BASE UNITS H 73

LE BASI NON SONO COMPRENSIVE DI TOP
THE BASE UNITS DO NOT INCLUDE THE TOPS

COD.

MELAMI-
NICO
K33

LACCATO
OPACO
K34

sottolavello H 73
1 anta
sink base unit H 73
1 door



L 45

E5060451/2

185

192

L 60

E5060601/2

203

216

sottolavello H 73
2 ante
sink base unit H 73
2 doors



L 90

E5060900

311

323

L 120

E5061200

353

388

sottolavello H 73
1 cestone H 60 con scarico salvaspazio
sink base unit H 73
1 deep drawer H 60 with space-saver drain piping

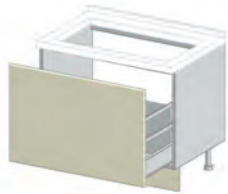

L 60

E5260600

292

302

L 90

E5260900

339







354



BASI SOSPENSE con Attaccaglie e Barre Fissaggio a parete

H 36 - 48 - 60 P 61

HANGING BASE UNITS with Hangers and Rods for wall mounting

Le basi non sono comprensive di top - N.B.: cerniere ammortizzate di serie
 The base units do not include the tops - Note: standard blumotion hinges

		COD.	MELAMINICO K33	LACCATO OPACO K34				
 <p>base H 36 1 anta base unit H 36 1 door</p>	L 45	E4321451/2	164	180				
	L 60	E4321601/2	179	183				
 <p>base H 48 1 anta base unit H 48 1 door</p>	L 45	E4320451/2	186	192				
	L 60	E4320601/2	203	210				
 <p>base H 60 1 anta base unit H 60 1 door</p>	L 45	E4322451/2	206	209				
	L 60	E4322601/2	221	231				
 <p>base H 36 2 ante base unit H 36 2 doors</p>	L 90	E4321900	263	294				
	L 120	E4322200	298	305				
 <p>base H 48 2 ante base unit H 48 2 doors</p>	L 90	E4320900	298	310				
	L 120	E4321200	339	352				
 <p>base H 60 2 ante base unit H 60 2 doors</p>	L 90	E4322900	329	335				

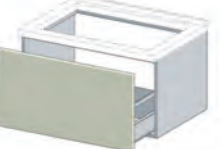
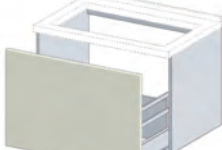
Le basi non sono comprensive di top - N.B.: cassetti e cestoni ad estrazione totale con blumotion The base units do not include the tops - Note: fully extending drawers and deep drawers with blumotion system		COD.	MELAMI- NICO K33	LACCATO OPACO K34					
	base H 36 1 cestone base H 36 1 deep drawer	L 45	E4311450	210	227				
	L 60	E4311600	227	231					
	L 90	E4311900	267	267					
		base H 48 1 cestone base unit H 48 1 deep drawer	L 45	E4310450	224	231			
L 60		E4310600	244	250					
L 90		E4310900	291	297					
	base H 60 1 cestone 1 cassetto interno base unit H 60 1 deep drawer 1 internal drawer	L 45	E4312450	343	347				
	L 60	E4312600	365	375					
	L 90	E4312900	432	447					
	sottolavello H 48 1 cestone sagomato scarico salvaspazio sink base unit H 48 1 contoured deep drawer space-saver drain piping	L 90	E5240900	358	364				
		sottolavello H 60 1 cestone scarico salvaspazio sink base unit H 60 1 deep drawer with space-saver drain piping	L 60	E5250600	313	323			
L 90		E5250900	358	373					

COMPOSIZIONE CON ELEMENTI INCLINATI

COMPOSITION WITH INCLINED ELEMENTS

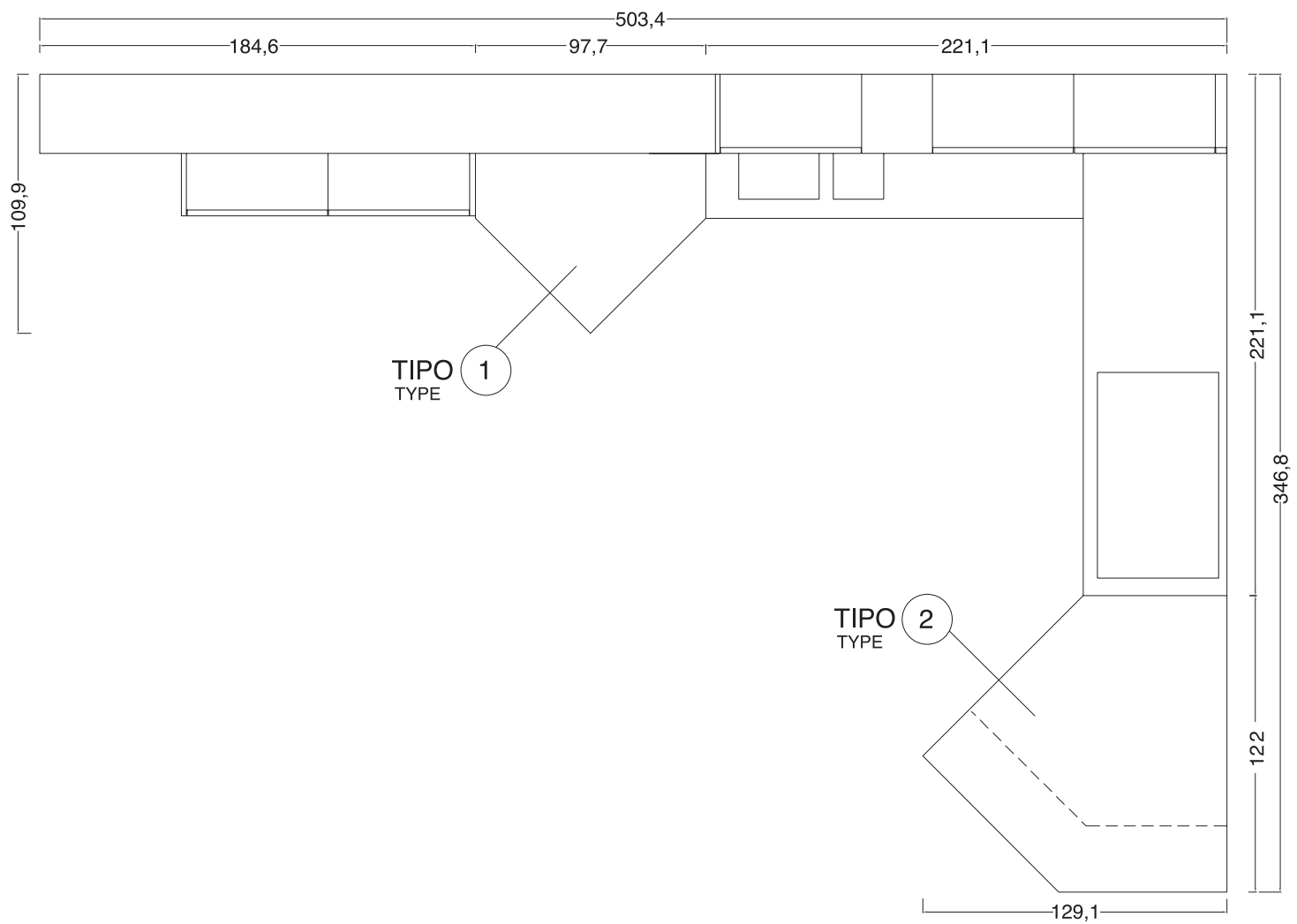
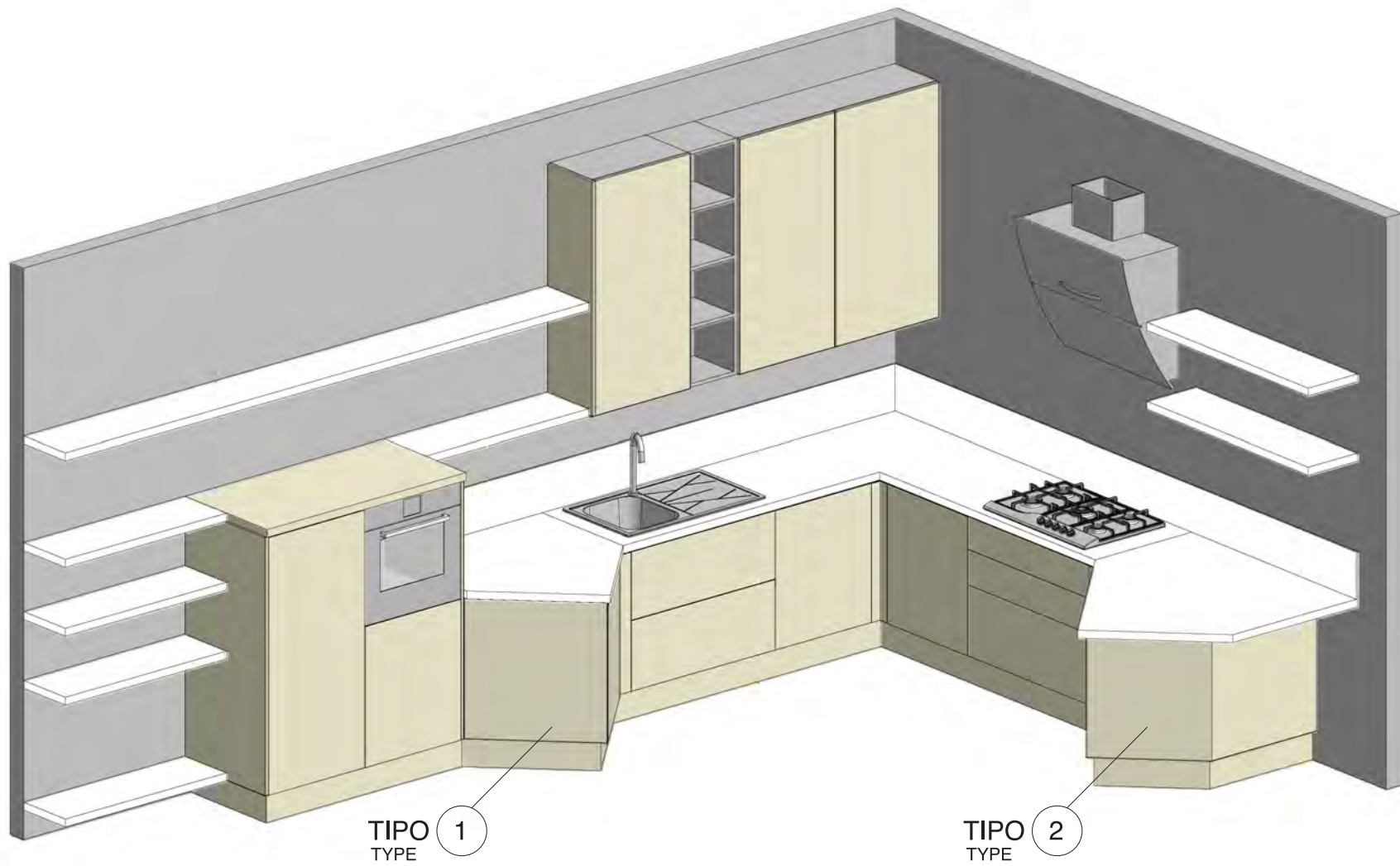

BASE INCLINATA "TIPO 1"

INCLINED BASE UNIT "TYPE 1"

LE BASI NON SONO COMPRENSIVE DI TOP
THE BASE UNITS DO NOT INCLUDE THE TOPS

kit base inclinata "tipo 1" per vano L 60
inclined base unit "type 1" kit W 60



kit "tipo 1"
"type 1" kit

mag. inserimento fianco per lavastoviglie dx o sx
surcharge for dishwasher side panel placed on RH or LH side

top per base inclinata "tipo 1"
worktop for inclined base unit "type 1"

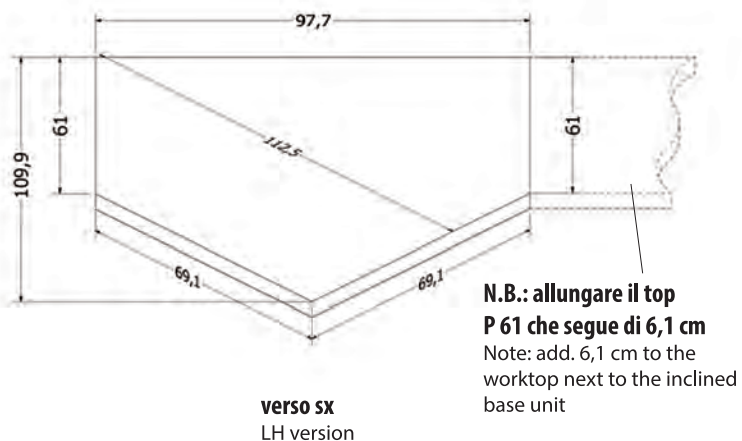

verso sx
LH version

N.B.: allungare il top P 61 che segue di 6,1 cm
Note: add 6,1 cm to the worktop next to the inclined base unit

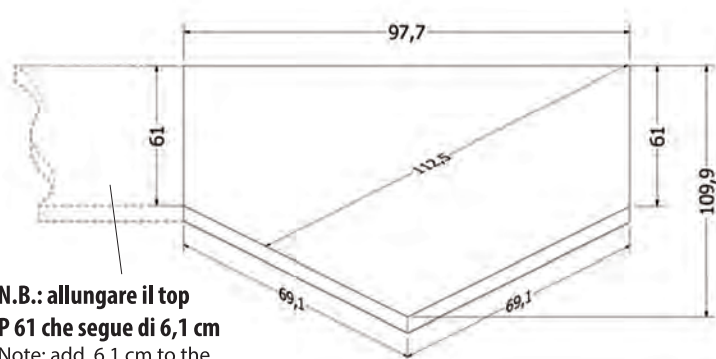

verso dx
RH version

97,7x109,9 lamin.bordo ABS1

H 4

T9062621/2

422

422

97,7x109,9 laminato Fenix
NTM

H 2

TFEN2681/2

428

428

H 4

TFEN4681/2

428

428

97,7x109,9 quarzo pasta piena
profilo P

H 2

TQRP2681/2

840

840

fascia "A"

840

840

fascia "B"

896

896

fascia "C"

968

968

H 3

TQRP3681/2

859

859

fascia "A"

859

859

fascia "B"

952

952

fascia "C"

1.024

1.024

97,7x109,9 quarzo bordo
quarzo profilo P

H 4

TQRP4681/2

1.002

1.002

fascia "A"

1.002

1.002

fascia "B"

1.096

1.096

fascia "C"

1.168

1.168

BASE INCLINATA SNACK "TIPO 2"

INCLINED SNACK BASE UNIT "TYPE 2"

LE BASI NON SONO COMPRENSIVE DI TOP
THE BASE UNITS DO NOT INCLUDE THE TOPS

kit base snack "tipo 2" per vano L 60
inclined snack base unit "type 2" kit W 60

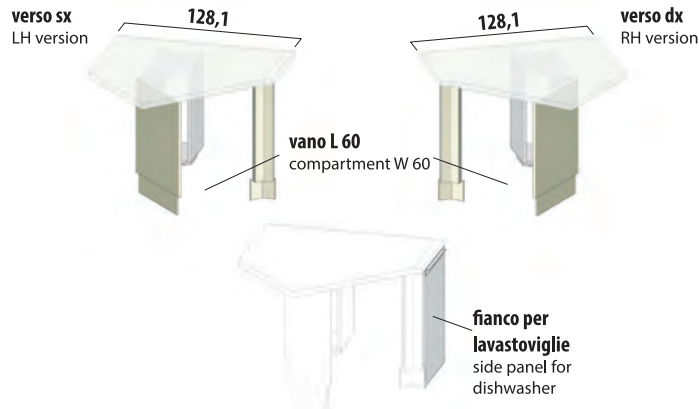

kit "tipo 2"
"type 2" kit

mag. inserimento fianco per lavastoviglie dx o sx
surcharge for dishwasher side panel placed on RH or LH side

top per base snack "tipo 2"
worktop for inclined snack base unit "type 2"

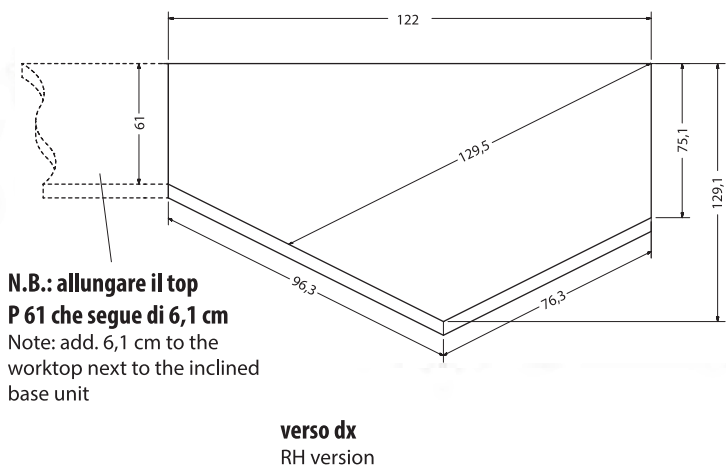
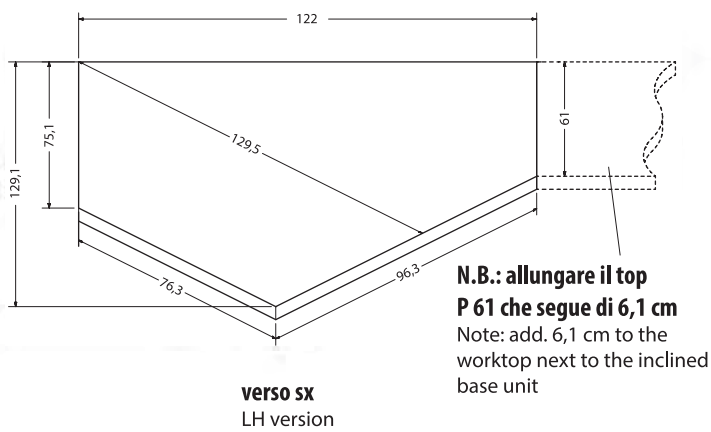

122x129,1 lamin.bordo ABS1

H 4

T9062631/2

429

429

122x129,1 laminato Fenix NTM

H 2

TFEN2691/2

519

519

H 4

TFEN4691/2

519

519

122x129,1 quarzo pasta piena profilo P

H 2

TQRP2691/2

fascia "A"

865

865

fascia "B"

959

959

fascia "C"

1.030

1.030

H 3

TQRP3691/2

fascia "A"

885

885

fascia "B"

975

975

fascia "C"

1.044

1.044

Foro rettangolare

T9FRE

85

85

122x129,1 quarzo bordo quarzo profilo P

H 4

TQRP4691/2

fascia "A"

1.065

1.065

fascia "B"

1.158

1.158

fascia "C"

1.230







1.230





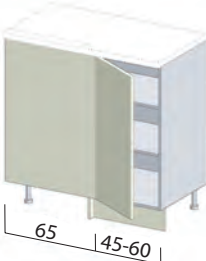

Foro rettangolare







T9FRE

85







85







Le colonne non sono comprensive di top - N.B.: cerniere ammortizzate di serie The columns do not include the tops - Note: standard blumotion hinges		COD.	MELAMINICO K33	LACCATO OPACO K34				
 <p>fascia tamponamento da 5 a 10 N.B.: realizzata con cornice come anta filler panel size from 5 to 10 Note: realized with frame as door</p>								
	<p>in nobilitato melamine coated</p>	E6000010	50	50				
	<p>come anta con supporto same as door with support</p>	E6000140	142	151				
 <p>1 anta 1 door</p>								
	L 30	E6040301/2	243	237				
	L 40	E6040401/2	261	266				
	L 45	E6040451/2	271	276				
	L 60	E6040601/2	303	325				
 <p>2 ante 2 ripiani con tirante centrale 2 doors 2 shelves with central tie beam</p>								
	L 90	E6041900	462	471				
 <p>1 cassetto H 24 2 cestoni H 36 1 drawer H 24 2 deep drawers H 36</p>								
	L 60	E6031620	533	538				
 <p>predisposta per lavastoviglie Electrolux TT C 1003 configured for Electrolux TT C 1003 dishwasher</p>								
	L 60	E6570600	372	381				
 <p>angolo 2 ripiani con tirante centrale 1 anta (cerniere a pilastro) pannello come anta sp. 2,2 (impiallacciato per la versione melaminico) corner unit 2 shelves with central tie beam 1 door (pillar hinges) panel as door Th. 2,2 (veneered panel for melamine version)</p>								
	L 110	E6327101/2	573	561				
	L 125	E6327251/2	583	572				
 <p>jolly colonna L da 10 a 30 jolly column size from 10 to 30</p>								
	<p>colore come struttura same colour as carcass</p>	E6000900	175	175				
	<p>melaminico come anta melamine same as door</p>	E6000930	253	—				
	<p>laccato come anta lacquered same as door</p>	E6006050	—	579				





Le colonne non sono comprensive di top - N.B.: cerniere ammortizzate di serie The columns units do not include the tops - Note: standard blumotion hinges		COD.	MELAMINICO K33	LACCATO OPACO K34				
 <p>fascia tamponamento da 5 a 10 N.B.: realizzata con cornice come anta filler panel size from 5 to 10 Note: realized with frame as door</p>								
	<p>in nobilitato melamine coated</p>	E6000020	51	51				
	<p>come anta con supporto same as door with support</p>	E6000150	144	187				
 <p>1 anta 1 door</p>								
	L 30	E6050301/2	288	279				
	L 45	E6050451/2	325	335				
L 60	E6050601/2	363	390					
 <p>2 ante 2 ripiani con tirante centrale 2 doors 2 shelves with central tie beam</p>								
	L 90	E6050900	570	589				
 <p>1 anta integrata al gruppo cestelli estraibili in filo cromati chiusura soft 1 door incorporated into the chromed wire pull-out basket units soft-closing system</p>								
	L 30	E6150300	523	514				
 <p>1 anta gruppo cestelli estraibili in filo cromati chiusura soft 1 door chromed wire pull-out basket units soft-closing system</p>								
	L 45	E6150451/2	564	573				
	L 60	E6150601/2	616	641				
 <p>angolo 2 ripiani con tirante centrale 1 anta (cerniere a pilastro) pannello come anta sp.2,2 (impiallacciato per la versione melaminico) corner unit 2 shelves with central tie beam 1 door (hinges pillar) panel as door Th. 2,2 (veneered panel for melamine version)</p>								
	L 110	E6336101/2	706	695				
L 125	E6336251/2	716	708					
 <p>jolly colonna L da 10 a 30 jolly column size from 10 to 30</p>								
	<p>colore come struttura same colour as carcass</p>	E6001000	203	203				
	<p>melaminico come anta melamine same as door</p>	E6001030	315	—				
<p>laccato come anta lacquered same as door</p>	E6006100	—	759					







N.B.: cerniere ammortizzate di serie Note: standard blumotion hinges		COD.	MELAMI- NICO K33	LACCATO OPACO K34				
 <p>204</p> <p>fascia tamponamento da 5 a 10 N.B.: realizzata con cornice come anta filler panel size from 5 to 10 Note: realized with frame as door</p>								
	in nobilitato melamine coated	E6000050	58	58				
	come anta con supporto same as door with support	E6000200	235	307				
 <p>2 ante anta superiore H 72 anta inferiore H 132 2 doors upper door H 72 lower door H 132</p>	L 45 P 33,4	E6013451/2	445	460				
	L 60 P 33,4	E6013601/2	506	549				
 <p>2 ante anta superiore H 72 anta inferiore H 132 2 doors upper door H 72 lower door H 132</p>	L 30 P 59,9	E6060301/2	443	431				
	L 45 P 59,9	E6063451/2	495	510				
	L 60 P 59,9	E6063601/2	564	607				
 <p>2 ante anta superiore H 132 anta inferiore H 72 2 doors upper door H 132 lower door H 72</p>	L 45 P 33,4	E6010451/2	445	460				
	L 60 P 33,4	E6010601/2	506	549				
 <p>2 ante anta superiore H 132 anta inferiore H 72 2 doors upper door H 132 lower door H 72</p>	L 45 P 59,9	E6060451/2	495	510				
	L 60 P 59,9	E6060601/2	564	607				
 <p>4 ante 2 ante superiori H 132 2 ante inferiori H 72 4 ripiani con tirante centrale 4 doors 2 upper doors H 132 2 lower doors H 72 4 shelves with central tie beam</p>	L 90 P 59,9	E6060900	853	883				

N.B.: cassetti e cestoni ad estrazione totale con blumotion
 Note: fully extending drawers and deep drawers with blumotion system







		COD.	MELAMINICO K33	LACCATO OPACO K34				
 <p>portascope 2 ante anta superiore H 72 anta inferiore H 132 broom cabinet 2 doors upper door H 72 lower door H 132</p>	L 30	E6100301/2	442	429				
	L 45	E6100451/2	486	502				
 <p>portascope con ripiani 2 ante anta superiore H 72 anta inferiore H 132 broom cabinet with shelves 2 doors upper door H 72 lower door H 132</p>	L 60	E6100601/2	575	618				
 <p>1 anta H 204 1 door H 204</p>	L 45	E6061451/2	477	496				
	L 60	E6061601/2	512	595				
 <p>2 ante H 204 4 ripiani con tirante centrale 2 doors H 204 4 shelves with central tie beam</p>	L 90	E6061900	821	858				
 <p>portascope 1 anta H 204 broom cabinet 1 door H 204</p>	L 45	E6100461/2	457	476				
 <p>portascope con ripiani 1 anta H 204 broom cabinet with shelves 1 door H 204</p>	L 60	E6100611/2	533	616				



N.B.: cassetti e cestoni ad estrazione totale con blumotion Note: fully extending drawers and deep drawers with blumotion system		COD.	MELAMI-	LACCATO					
			NICO	OPACO					
			K33	K34					
 <p>1 anta H 132 4 cassetti H 18 1 door H 132 4 drawers H 18</p>	L 45	E6065451/2	756	759					
	L 60	E6065601/2	852	836					
 <p>1 anta H 132 2 cassetti H 18 1 cestone H 36 1 door H 132 2 drawers H 18 1 deep drawer H 36</p>	L 45	E6065461/2	679	701					
	L 60	E6065611/2	758	767					
 <p>1 anta H 132 2 cestoni H 36 1 door H 132 2 deep drawers H 36</p>	L 45	E6066451/2	602	643					
	L 60	E6066601/2	664	697					
 <p>anta H 204 integrata al gruppo cestelli estraibili in filo cromati chiusura soft door H 204 incorporated into the chromed wire pull-out basket unit soft-closing system</p>	L 30	E6163300	720	715					
	L 45	E6163450	786	803					
 <p>1 anta superiore H 72 1 anta H 132 integrata al gruppo cestelli estraibili in filo cromati chiusura soft 1 upper door H 72 1 door H 132 incorporated into the chromed wire pull-out basket unit soft-closing system</p>	L 30	E6160301/2	667	654					
	 <p>1 anta superiore H 72 1 anta inferiore H 132 gruppo cestelli estraibili in filo cromati chiusura soft 1 upper door H 72 1 lower door H 132 chromed wire pull-out basket units soft-closing system</p>	L 45	E6160451/2	723	738				
L 60		E6160601/2	791	830					

N.B.: cassetti e cestoni ad estrazione totale con blumotion Note: fully extending drawers and deep drawers with blumotion system		COD.	MELAMINICO K33	LACCATO OPACO K34				
 <p> 1 anta superiore H 72 (cerniere 100°) 1 anta inferiore H 132 (cerniere 180°) 1 cassetto interno 3 cestoni interni posizionare sempre a 5 cm dalla parete laterale 1 upper door H 72 (100° hinges) 1 lower door H 132 (180° hinges) 1 internal drawer 3 internal deep drawers should always be placed at 5 cm from the side wall </p>	L 45	E6086481/2	728	742				
	L 60	E6086631/2	796	835				
 <p> jolly colonna L da 15 a 30 jolly column size from 15 to 30 </p>								
		E6002000	239	239				
	colore come struttura same colour as carcass melaminico come anta melamine same as door laccato come anta lacquered same as door		E6002030	428	—			
		E6006200	—	1.101				
 <p> angolo 4 ripiani con tirante centrale 1 anta superiore H 72 1 anta inferiore H 132 (cerniere a pilastro) pannello come anta sp.2,2 (impiallacciato per la versione melaminico) corner unit 4 shelves with central tie beam 1 upper door H 72 1 lower door H 132 (pillar hinges) panel as door Th. 2,2 (veneered panel for melamine version) </p>	L 110	E6306101/2	1.048	1.035				
	L 125	E6306251/2	1.068	1.053				
 <p> angolo 1 anta H 204 cerniere 135° 2 fianchi sp. 3,8 come struttura N.B.: fornita smontata corner 1 door H 204 135° hinges 2 side panels Th.3,8 same as carcass Note: supplied unassembled </p>	105,5x105,5	E6341051/2	1.103	1.181				

N.B.: cerniere ammortizzate di serie Note: standard blumotion hinges		COD.	MELAMI- NICO K33	LACCATO OPACO K34				
 <p>fascia tamponamento da 5 a 10 N.B.: realizzata con cornice come anta filler panel size from 5 to 10 Note: realized with frame as door</p>								
	in nobilitato melamine coated	E6000100	58	58				
	come anta con supporto same as door with support	E6000250	250	307				
 <p>2 ante anta superiore H 96 anta inferiore H 132 2 doors upper door H 96 lower door H 132</p>	L 45 P 33,4	E6023451/2	518	532				
	L 60 P 33,4	E6023601/2	591	640				
 <p>2 ante anta superiore H 96 anta inferiore H 132 2 doors upper door H 96 lower door H 132</p>	L 30 P 59,9	E6070301/2	483	466				
	L 45 P 59,9	E6073451/2	542	556				
	L 60 P 59,9	E6073601/2	624	673				
 <p>2 ante anta superiore H 156 anta inferiore H 72 2 doors upper door H 156 lower door H 72</p>	L 45 P 33,4	E6020451/2	526	540				
	L 60 P 33,4	E6020601/2	595	655				
 <p>2 ante anta superiore H 156 anta inferiore H 72 2 doors upper door H 156 lower door H 72</p>	L 45 P 59,9	E6070451/2	551	565				
	L 60 P 59,9	E6070601/2	628	688				
 <p>4 ante 2 ante superiori H 156 2 ante inferiori H 72 4 ripiani con tirante centrale 4 doors 2 upper doors H 156 2 lower doors H 72 4 shelves with central tie beam</p>	L 90 P 59,7	E6070900	949	976				

N.B.: cassetti e cestoni ad estrazione totale con blumotion
 Note: fully extending drawers and deep drawers with blumotion system

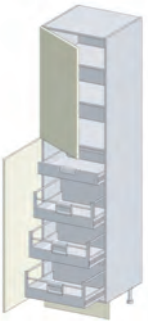
		MELAMI- NICO K33	LACCATO OPACO K34					
 <p>portascope 1 anta superiore H 96 1 anta inferiore H 132 broom cabinet 1 upper door H 96 1 lower door H 132</p>	L 30	E6110301/2	482	465				
	L 45	E6110451/2	534	548				
	L 60	E6110601/2	621	669				
 <p>portascope con ripiani 1 anta superiore H 96 1 anta inferiore H 132 broom cabinet with shelves 1 upper door H 96 1 lower door H 132</p>	L 60	E6110601/2	621	669				
	L 45	E6075451/2	807	808				
	L 60	E6075601/2	909	908				
 <p>1 anta H 156 4 cassetti H 18 1 door H 156 4 drawers H 18</p>	L 45	E6075451/2	807	808				
	L 60	E6075601/2	909	908				
	L 45	E6075461/2	730	750				
 <p>1 anta H 156 2 cassetti H 18 1 cestone H 36 1 door H 156 2 drawers H 18 1 deep drawer H 36</p>	L 60	E6075611/2	815	838				
	L 45	E6075461/2	730	750				
	L 60	E6075611/2	815	838				
 <p>1 anta H 156 2 cestoni H 36 1 door H 156 2 deep drawers H 36</p>	L 45	E6076451/2	652	692				
	L 60	E6076601/2	721	769				
	L 30	E6170301/2	703	688				
 <p>1 anta superiore H 96 1 anta H 132 integrata al gruppo cestelli estraibili in filo cromati chiusura soft 1 upper door H 96 1 door H 132 incorporated into the chromed wire pull-out basket units soft-closing system</p>	L 30	E6170301/2	703	688				

N.B.: cassetti e cestoni ad estrazione totale con blumotion Note: fully extending drawers and deep drawers with blumotion system		COD.	MELAMI- NICO K33	LACCATO OPACO K34				
	1 anta superiore H 96 1 anta inferiore H 132 gruppo cestelli estraibili in filo cromati chiusura soft 1 upper door H 96 1 lower door H 132 chromed wire pull-out basket units soft-closing system	L 45	E6170451/2	768	780			
		L 60	E6170601/2	846	890			
	1 anta superiore H 96 (cerniere 100°) 1 anta inferiore H 132 (cerniere 180°) 1 cassetto interno 3 cestoni interni posizionare sempre a 5 cm dalla parete laterale 1 upper door H 96 (100° hinges) 1 lower door H 132 (180° hinges) 1 internal drawer 3 internal deep drawers should always be placed at 5 cm from the side wall	L 45	E6088481/2	772	784			
		L 60	E6088631/2	850	893			
	jolly colonna L da 15 a 30 jolly column size from 15 to 30							
	colore come struttura same colour as carcass	E6003000	267	267				
	melaminico come anta melamine same as door	E6003030	460	—				
laccato come anta lacquered same as door	E6006250	—	1.230					

N.B.: cerniere ammortizzate di serie
 Note: standard blumotion hinges

COD.

MELAMI- NICO K33	LACCATO OPACO K34
------------------------	-------------------------



angolo 5 ripiani con tirante centrale
1 anta superiore H 96
1 anta inferiore H 132
(cerniere a pilastro)
pannello come anta sp. 2,2
(impiallacciato per la versione melaminico)
 corner unit 5 shelves with central tie beam
 1 upper door H 96
 1 lower door H 132
 (pillar hinges)
 panel as door Th. 2,2
 (veneered panel for melamine version)

L 110

E6316101/2

1.164

1.138

L 125

E6316251/2

1.185

1.174



angolo 1 anta H 228 (156+72) cerniere 135°
2 fianchi sp. 3,8 come struttura
N.B.: fornita smontata
 corner 1 door H 228 (156+72) 135° hinges
 2 side panels Th.3,8 same as carcass
Note: supplied unassembled

105,5x105,5

E6342051/2







1.247

1.248

COLONNE PER FORNO H 109

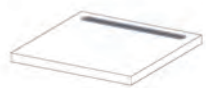
P 59,9

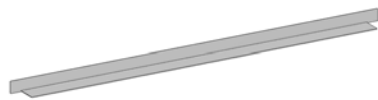
OVEN COLUMNS H 109

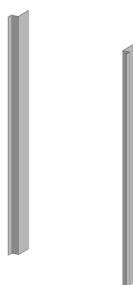



Le colonne non sono comprensive di top - N.B.: cassetti e cestoni ad estrazione totale con blumotion The columns do not include the tops - Note: fully extending drawers and deep drawers with blumotion system		COD.	MELAMINICO K33	LACCATO OPACO K34				
 <p>colonna H 109 per forno 2 cassetti H 18 oven column H 109 2 drawers H 18</p>	L 60	E6501660	380	359				
	 <p>colonna H 109 per forno 1 cassetto H 12 1 cassetto H 24 oven column H 109 1 drawer H 12 1 drawer H 24</p>	L 60	E6501650	390	373			
 <p>colonna H 109 per forno 1 cestone chiuso H 36 oven column H 109 1 full deep drawer H 36</p>		L 60	E6501600	285	289			
	 <p>top H 1,8 come anta P 59,9 per colonne worktop H 1,8 same as door D 59,9 for columns</p>							
melaminico al ml melamine per lm		TLE189	77	—				
laccato al ml lacquered per lm		TLC189	—	215				
mag.griglia di areazione cad. surcharge for ventilation grille each		T9FGA	30	30				
 <p>profilo in acciaio a "L" per rifinire il ripiano del forno e microonde L-shaped steel finishing profile for shelf of oven and microwave</p> 	L 60							
	inox stainless steel	08660100	9	9				
	nero black	08660101	9	9				
bianco white	08660102	9	9					
 <p>kit protezione fianchi per forno protection kit sides for oven</p> 	L 90							
	inox stainless steel	08660105	12	12				
	coppia couple	08630095	16	16				

COLONNE PER FORNO H 145

P 59,9

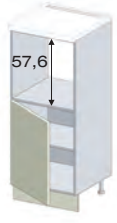
OVEN COLUMNS H 145

Le colonne non sono comprensive di top - N.B.: cerniere ammortizzate di serie
 The columns do not include the tops - Note: standard blumotion hinges

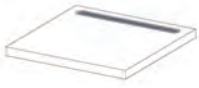





	COD.	MELAMINICO K33	LACCATO OPACO K34				
 <p>colonna H 145 per forno 1 anta H 72 oven column H 145 1 door H 72</p>	L 60	E6520601/2	299	313			
 <p>colonna H 145 per forno 4 cassetti H 18 oven column H 145 4 drawers H 18</p>	L 60	E6521610	635	594			
 <p>colonna H 145 per forno 2 cassetti H 18 1 cestone H 36 oven column H 145 2 drawers H 18 1 deep drawer H 36</p>	L 60	E6521620	541	524			
 <p>colonna H 145 per forno 2 cestoni H 36 oven column H 145 2 deep drawers H 36</p>	L 60	E6521630	450	458			
 <p>colonna H 145 per forno per maxiforno H 48 1 cassetto H 18 2 ante H 60 oven column H 145 for maxi-oven H 48 1 drawer H 18 2 doors H 60</p>	L 90	E6521910	617	537			
 <p>top H 1,8 come anta P 59,9 per colonne worktop H 1,8 same as door D 59,9 for columns</p>							
<p>melaminico al ml melamine per 1m</p>		TLE189	77	—			
<p>laccato al ml lacquered per 1m</p>		TLC189	—	215			
<p>mag.griglia di areazione cad. surcharge for ventilation grille each</p>		T9FGA	30	30			

COLONNE PER FORNO H 217





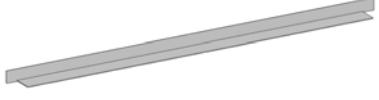

P 59,9

OVEN COLUMNS H 217

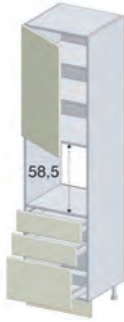

N.B.: cassetti e cestoni ad estrazione totale con blumotion
 Note: fully extending drawers and deep drawers with blumotion system

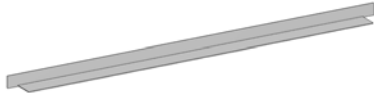

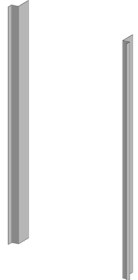
	COD.	MELAMI- NICO K33	LACCATO OPACO K34				
 <p>colonna per forno 1 anta superiore H 72 1 anta inferiore H 72 oven column 1 upper door H 72 1 lower door H 72</p>	L 60	E6530601/2	481	510			
 <p>colonna per forno 1 anta H 72 4 cassetti H 18 oven column 1 door H 72 4 drawers H 18</p>	L 60	E6531611/2	828	801			
 <p>colonna per forno 1 anta H 72 2 cassetti H 18 1 cestone H 36 oven column 1 door H 72 2 drawers H 18 1 deep drawer H 36</p>	L 60	E6531621/2	733	731			
 <p>colonna per forno 1 anta H 72 2 cestoni H 36 oven column 1 door H 72 2 deep drawers H 36</p>	L 60	E6531631/2	639	661			
 <p>profilo in acciaio a "L" per rifinire il ripiano del forno e microonde L-shaped steel finishing profile for shelf of oven and microwave</p>	L 60						
	inox stainless steel	08660100	9	9			
	nero black	08660101	9	9			
	bianco white	08660102	9	9			
 <p>kit protezione fianchi per forno protection kit sides for oven</p>	coppia couple	08630095	16	16			

N.B.: cassetti e cestoni ad estrazione totale con blumotion
 Note: fully extending drawers and deep drawers with blumotion system



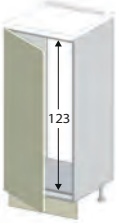
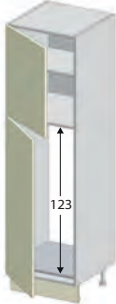
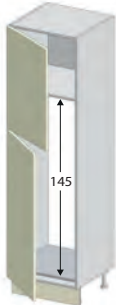
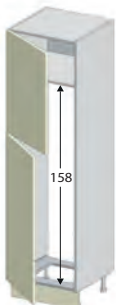

	COD.	MELAMI-NICO K33	LACCATO OPACO K34				
 <p>colonna per forno 1 anta superiore H 96 1 anta inferiore H 72 oven column 1 upper door H 96 1 lower door H 72</p>	L 60	E6540601/2	539	572			
 <p>colonna per forno 1 anta H 96 4 cassetti H 18 oven column 1 door H 96 4 drawers H 18</p>	L 60	E6541611/2	883	861			
 <p>colonna per forno 1 anta superiore H 96 2 cassetti H 18 1 cestone H 36 oven column 1 upper door H 96 2 drawers H 18 1 deep drawer H 36</p>	L 60	E6541621/2	789	791			
 <p>colonna per forno 1 anta superiore H 96 2 cestoni H 36 oven column 1 upper door H 96 2 deep drawers H 36</p>	L 60	E6541631/2	694	721			
 <p>profilo in acciaio a "L" per rifinire il ripiano del forno e microonde L-shaped steel finishing profile for shelf of oven and microwave</p> 	L 60						
	inox stainless steel	08660100	9	9			
	nero black	08660101	9	9			
	bianco white	08660102	9	9			
 <p>kit protezione fianchi per forno protection kit sides for oven</p> 	coppia couple	08630095	16	16			

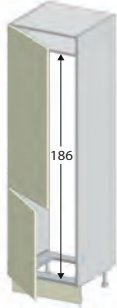
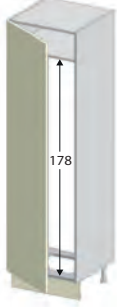
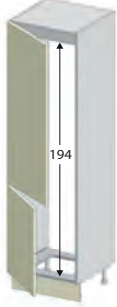

N.B.: cassetti e cestoni ad estrazione totale con blumotion
 Note: fully extending drawers and deep drawers with blumotion system

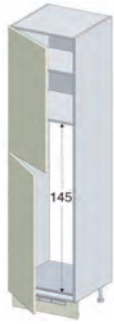
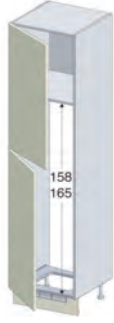

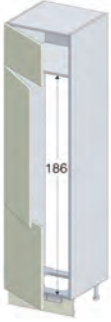
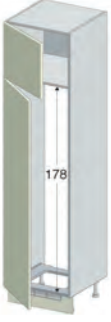

	COD.	MELAMINICO K33	LACCATO OPACO K34					
 <p>colonna per forno e micro 1 anta superiore H 72 vano micro da H 36,5 a 46,5 cestone H 48 oven and microwave column 1 upper door H 72 microwave compartment H 36,5 to 46,5 deep drawer H 48</p> <p>min. 36,5 max. 46,5 58,5</p>	L 60	E6561601/2	695	693				
	 <p>colonna per forno 1 anta superiore H 72 1 anta H 48 sollevamento verticale 1 cestone H 48 oven column 1 upper door H 72 1 door H 48 vertical opening 1 deep drawer H 48</p> <p>58,5</p>	L 60	E6564601/2	758	786			
 <p>colonna per forno e lavastoviglie Electrolux TT C 1003 1 anta superiore H 72 1 anta lavastoviglie H 72 1 cassetto H 24 column for oven and Electrolux TT C 1003 dishwasher 1 upper door H 72 1 dishwasher door H 72 1 drawer H 24</p> <p>58,5</p>		L 60	E6575601/2	604	627			

Le colonne non sono comprensive di top The columns do not include the tops		COD.	MELAMI- NICO K33	LACCATO OPACO K34				
 <p>colonna H 145 per frigo 215 monoporta column H 145 for single-door fridge 215</p>								
	L 60	E6452151/2	360	386				
 <p>colonna H 217 per frigo 215 monoporta 1 anta superiore H 72 1 anta inferiore H 132 column H 217 for 215 single-door fridge 1 upper door H 72 1 lower door H 132</p>								
	L 60	E6462151/2	516	507				
 <p>colonna H 217 per frigo-freezer 230 1 anta superiore H 84 1 anta inferiore H 120 column H 217 for 230 fridge-freezer 1 upper door H 84 1 lower door H 120</p>								
	L 60	E6462311/2	516	507				
 <p>colonna H 217 per frigo-freezer 280 1 anta superiore H 84 1 anta inferiore H 120 column H 217 for 280 fridge-freezer 1 upper door H 84 1 lower door H 120</p>								
	L 60	E6462861/2	516	507				
 <p>colonna H 217 per frigo-congelatore 315 1 anta superiore H 132 1 anta inferiore H 72 column H 217 for 315 fridge-freezer 1 upper door H 132 1 lower door H 72</p>								
	L 60	E6463151/2	516	507				
 <p>colonna H 217 per frigo-congelatore 315 1 anta superiore H 24 1 anta centrale H 108 1 anta inferiore H 72 column H 217 for 315 fridge-freezer 1 upper door H 24 1 central door H 108 1 lower door H 72</p>								
	L 60	E6463161/2	580	560				





	COD.	MELAMINICO K33	LACCATO OPACO K34					
 <p>colonna H 217 per frigo-congelatore 330 1 anta superiore H 132 1 anta inferiore H 72 column H 217 for 330 fridge-freezer 1 upper door H 132 1 lower door H 72</p>	L 60	E6463301/2	516	507				
	 <p>colonna H 217 per frigo-freezer 300 monoporta 1 anta H 204 column H 217 for 300 single-door fridge-freezer 1 door H 204</p>	L 60	E6463001/2	516	507			
 <p>colonna H 217 per frigo-congelatore 350 1 anta superiore H 132 1 anta inferiore H 72 column H 217 for 350 fridge-freezer 1 upper door H 132 1 lower door H 72</p>								
	Whirlpool - Hotpoint	L 60	E6463511/2	516	507			

		COD.	MELAMI- NICO K33	LACCATO OPACO K34					
 <p>colonna H 241 per frigo 215 monoporta 1 anta superiore H 96 1 anta inferiore H 132 column H 241 for 215 single-door fridge 1 upper door H 96 1 lower door H 132</p>									
	L 60	E6472151/2	564	566					
 <p>colonna H 241 per frigo-freezer 230 1 anta superiore H 108 1 anta inferiore H 120 column H 241 for 230 fridge-freezer 1 upper door H 108 1 lower door H 120</p>									
	L 60	E6472311/2	564	566					
 <p>colonna H 241 per frigo-freezer 280 1 anta superiore H 108 1 anta inferiore H 120 column H 241 for 280 fridge-freezer 1 upper door H 108 1 lower door H 120</p>									
	L 60	E6472861/2	564	566					
 <p>colonna H 241 per frigo-congelatore 315 1 anta superiore H 156 1 anta inferiore H 72 column H 241 for 315 fridge-freezer 1 upper door H 156 1 lower door H 72</p>									
	L 60	E6473151/2	564	566					
 <p>colonna H 241 per frigo-congelatore 315 1 anta superiore H 48 1 anta centrale H 108 1 anta inferiore H 72 column H 241 for 315 fridge-freezer 1 upper door H 48 1 central door H 108 1 lower door H 72</p>									
	L 60	E6473161/2	609	597					
 <p>colonna H 241 per frigo-congelatore 330 1 anta superiore H 156 1 anta inferiore H 72 column H 241 for 330 fridge-freezer 1 upper door H 156 1 lower door H 72</p>									
	L 60	E6473301/2	564	566					



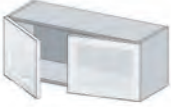

	COD.	MELAMINICO K33	LACCATO OPACO K34					
 <p>colonna H 241 per frigo-congelatore 330 1 anta superiore H 36 1 anta centrale H 120 1 anta inferiore H 72 column H 241 for 330 fridge-freezer 1 upper door H 36 1 central door H 120 1 lower door H 72</p>								
	L 60	E6473361/2	609	597				
 <p>colonna H 241 per frigo-congelatore 300 monoporta 1 anta superiore H 48 1 anta inferiore H 180 column H 241 for 300 single-door fridge-freezer 1 upper door H 48 1 lower door H 180</p>								
	L 60	E6473001/2	564	566				
 <p>colonna H 241 per frigo-congelatore 350 1 anta superiore H 156 1 anta inferiore H 72 column H 241 for 350 fridge-freezer 1 upper door H 156 1 lower door H 72</p>								
	Whirlpool Everest L 60	E6473511/2	564	566				



N.B.: apertura presa sul fondo o push-pull Note: grip on bottom or push-pull opening		COD.	NECK	BRIDGE				
 <p>1 anta H 36 1 door H 36</p>								
	L 45	G/E1032451/2	160	160				
	L 60	G/E1032601/2	178	178				
 <p>1 anta H 48 1 door H 48</p>								
	L 45	G/E1042451/2	186	186				
	L 60	G/E1042601/2	208	208				
 <p>1 anta H 60 1 door H 60</p>								
	L 60	G/E1062601/2	220	220				
 <p>1 anta H 72 1 door H 72</p>								
	L 45	G/E1012451/2	205	205				
	L 60	G/E1012601/2	234	234				
 <p>1 anta H 96 1 door H 96</p>								
	L 45	G/E1022451/2	250	250				
	L 60	G/E1022601/2	290	290				





N.B.: apertura presa sul fondo o push-pull
 Note: grip on bottom or push-pull opening



	COD.	NECK	BRIDGE					
<p>2 ante H 36 2 doors H 36</p> 	L 90	G/E1032905	288	288				
<p>2 ante H 48 2 doors H 48</p> 	L 90	G/E1042900	332	332				
<p>2 ante H 72 2 doors H 72</p> 	L 90	G/E1012900	373	373				
<p>2 ante H 96 2 doors H 96</p> 	L 90	G/E1022900	453	453				

ELEMENTI ANTA
 TELAIO ALLUMINIO
 ELEMENTS
 WITH ALUMINIUM FRAME

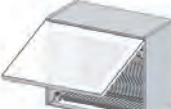
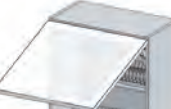

N.B.: apertura presa sul fondo Note: grip on bottom opening		COD.	NECK	BRIDGE				
 <p>anta ribalta H 36 N.B.: sovrapponibili solo con le ribalte tip-on flap door H 36 Note: overlapping only with tip-on flap doors</p>								
	L 45	G/E1102450	179	179				
	L 60	G/E1102600	196	196				
	L 90	G/E1102900	247	247				
 <p>anta ribalta H 48 N.B.: sovrapponibili solo con le ribalte tip-on flap door H 48 Note: overlapping only with tip-on flap doors</p>								
	L 45	G/E1122450	198	198				
	L 60	G/E1122600	234	234				
	L 90	G/E1122900	280	280				
 <p>anta ribalta H 60 N.B.: sovrapponibili solo con le ribalte tip-on flap door H 60 Note: overlapping only with tip-on flap doors</p>								
	L 60	G/E1132600	287	287				
	L 90	G/E1132900	366	366				
 <p>anta apertura verticale obliqua H 60 door with oblique vertical opening H 60</p>								
	L 60	G/E1207600	351	351				
	L 90	G/E1207900	414	414				
 <p>anta apertura verticale obliqua H 72 door with oblique vertical opening H 72</p>								
	L 60	G/E1202600	373	373				
	L 90	G/E1202900	436	436				

	COD.	NECK	BRIDGE					
 <p>anta ribalta TIP-ON H 36 flap door TIP-ON H 36</p>								
	L 45	G110246T	189	189				
	L 60	G110261T	207	207				
	L 90	G110291T	257	257				
 <p>anta ribalta TIP-ON H 48 flap door TIP-ON H 48</p>								
	L 45	G112246T	204	204				
	L 60	G112261T	239	239				
	L 90	G112291T	290	290				
 <p>anta ribalta TIP-ON H 60 flap door TIP-ON H 60</p>								
	L 60	G113261T	298	298				
	L 90	G113291T	376	376				

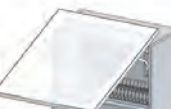
griglie inox stainless steel grilles	COD.	NECK	BRIDGE				
1 anta H 60 1 door H 60 	L 60	G/E3262601/2	238	238			
			+84	+84			
			mag.griglie con luce led surcharge grilles with led light				
1 anta H 72 1 door H 72 	L 45	G/E3212451/2	225	225			
	L 60	G/E3212601/2	253	253			
			+84	+84			
			mag.griglie con luce led surcharge grilles with led light				
1 anta H 96 1 door H 96 	L 45	G/E3222451/2	270	270			
	L 60	G/E3222601/2	313	313			
			+84	+84			
			mag.griglie con luce led surcharge grilles with led light				
2 ante H 72 2 doors H 72 	L 90	G/E3212900	403	403			
			+84	+84			
			mag.griglie con luce led surcharge grilles with led light				
2 ante H 96 2 doors H 96 	L 90	G/E3222900	482	482			
			+84	+84			
			mag.griglie con luce led surcharge grilles with led light				



griglie inox stainless steel grilles		COD.	NECK	BRIDGE					
 <p>anta ribalta H 36 flap door H 36</p>	L 60	G/E3132600	210	210					
	L 90	G/E3132900	268	268					
				+84	+84				
			mag.griglie con luce led surcharge grilles with led light						
 <p>anta ribalta H 48 flap door H 48</p>	L 60	G/E3142600	267	267					
	L 90	G/E3142900	314	314					
				+84	+84				
			mag.griglie con luce led surcharge grilles with led light						
 <p>anta ribalta H 60 flap door H 60</p>	L 60	G/E3152600	347	347					
	L 90	G/E3152900	458	458					
				+84	+84				
			mag.griglie con luce led surcharge grilles with led light						
 <p>anta apertura verticale obliqua H 60 door with vertical oblique opening H 60</p>	L 60	G/E3207600	347	347					
	L 90	G/E3207900	410	410					
				+84	+84				
			mag.griglie con luce led surcharge grilles with led light						
 <p>anta apertura verticale obliqua H 72 door with vertical oblique opening H 72</p>	L 60	G3202600	368	368					
	L 90	G3202900	431	431					
				+84	+84				
			mag.griglie con luce led surcharge grilles with led light						

Per la modulistica completa dei pensili P 33,4 consultare la sezione "Pensili"
 For complete modularity of wall units D 33,4 see "Wall units" section

	COD.	NECK	BRIDGE				
 <p>persile H 36 apertura a vasistas con push-pull (opz.996) wall unit H 36 flap door with push-pull opening (code 996)</p>	L 60	G1107600	237	237			
	L 90	G1107900	335	335			
 <p>persile H 48 apertura a vasistas con push-pull (opz.996) wall unit H 48 flap door with push-pull opening (code 996)</p>	L 60	G1125600	327	327			
	L 90	G1125900	373	373			

FIANCHI DI FINITURA



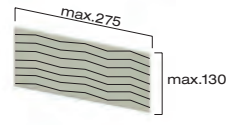
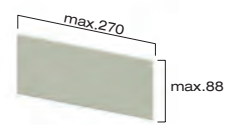

FINISHING SIDE PANELS

	COD.	NECK / BRIDGE						
		MELAMINICO	LACCATO OPACO					
<p>maggiorazione per fianchi di struttura come anta (cadauno) venatura verticale e tinta unita surcharge for carcass sides same finish as door (each) vertical grain and full colour</p> 								
	PENSILE WALL UNIT							
	36x31	+24	—					
	48x31	+26	—					
	60x31	+29	—					
	72x31	+34	—					
	96x31	+40	—					
	120x31	+42	—					
	132x31	+45	—					
	BASE NECK NECK BASE UNIT							
	37,5x57,5	+30	—					
	51x57,5	+33	—					
	63x57,5	+36	—					
	75x57,5	+39	—					
	BASE BRIDGE BRIDGE BASE UNIT							
	36x57,5	+30	—					
	48x57,5	+33	—					
	60x57,5	+36	—					
	72x57,5	+39	—					
	COLONNA COLUMN							
	132x31	+45	—					
	204x31	+55	—					
	228x31	+63	—					
	96x57,5	+44	—					
	132x57,5	+52	—					
	204x57,5	+64	—					
	228x57,5	+67	—					
	<p>pannello di finitura SP. 1,8 finitura come anta venature verticali (senza cornice) N.B.: quantità minima fatturabile 0,5 mq finishing panel TH. 1,8 same finish as door vertical grains (without frame) Note: 0,5 square meter, min.quantity that can be invoiced</p> 							
melaminico al mq melamine per m ²		094506V	114	—				
<p>pannello di finitura SP. 1,8 finitura come anta venature orizzontali (senza cornice) N.B.: quantità minima fatturabile 0,5 mq finishing panel TH. 1,8 same finish as door horizontal grains (without frame) Note: 0,5 square meter, min.quantity that can be invoiced</p> 								
	melaminico al mq melamine per m ²	094506	114	—				
<p>pannello di finitura SP. 1,8 come anta (senza cornice) N.B.: quantità minima fatturabile 0,5 mq finishing panel TH. 1,8 same finish as door (without frame) Note: 0,5 square meter, min.quantity that can be invoiced</p> 								
	laccato al mq lacquered per m ²	094528	—	381				

ANTE DI FINITURA
FINISHING DOORS

COPRIFIANCHI LACCATI



LACQUERED SIDE PANELS

	COD.	NECK						
		MELAMINICO K36	LACCATO OPACO K37					
 <p>Coprifianco LACCATO sp.1 mm per rifinire i fianchi a vista LACQUERED side panel th. 1 mm for visible sides finishing</p>								
	PENSILE WALL UNIT							
	36x31	T98340	—	47				
	48x31	T98345	—	48				
	60x31	T98350	—	50				
	72x31	T98355	—	54				
	96x31	T98360	—	65				
	120x31	T98365	—	78				
132x31	T98367	—	98					
 <p>Coprifianco LACCATO sp.1 mm per rifinire i fianchi a vista LACQUERED side panel th. 1 mm for visible sides finishing</p>								
	COLONNA COLUMN							
	132x31	T98367	—	98				
	204x31	T98375	—	130				
	228x31	T98380	—	132				
	96x57,5	T98320	—	92				
	132x57,5	T98325	—	136				
	204x57,5	T98330	—	201				
228x57,5	T98335	—	227					
 <p>coprifianco per base laccato colore come anta per rifinire i fianchi a vista scasso superiore per gola lacquered side panel for base unit same finish as doors for visible sides finishing upper cut-out for finger rail</p>								
	tipo "A" 1 gola type "A" 1 finger rail							
	H 37,5x57,5	T984101/2	—	78				
	H 51x57,5	T984151/2	—	95				
	H 63x57,5	T984201/2	—	98				
H 75x57,5	T984251/2	—	100					
 <p>coprifianco per base laccato colore come anta per rifinire i fianchi a vista scasso superiore ed intermedio per gola lacquered side panel for base unit same finish as doors for visible sides finishing upper and intermediate cut-out for finger rail</p>								
	tipo "B" 2 gole type "B" 2 finger rails							
	H 63x57,5	T984231/2	—	98				
H 75x57,5	T984271/2	—	100					
 <p>coprifianco per base laccato colore come anta per rifinire i fianchi a vista scasso intermedio per gola lacquered side panel for base unit same finish as doors for visible sides finishing intermediate cut-out for finger rail</p>								
	tipo "C" 1 gola type "C" 1 finger rail							
H 55x57,5	T984171/2	—	93					

ANTE DI FINITURA LATERALI

LATERAL FINISHING DOORS

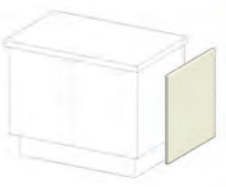
* Per il codice sostituire le XXX con il codice della versione corrispondente
 * Replace XXX with the concerning code version

	*COD.	NECK						
		MELAMI-NICO K36	LACCATO OPACO K37					
<p>ante di finitura laterali sp. 1,8 lateral finishing doors th. 1,8</p> 								
	PENSILE WALL UNIT							
	H 36 (35,7x33,4)	1XXX4045	68	75				
	H 48 (47,7x33,4)	1XXX4046	78	86				
	H 60 (59,7x33,4)	1XXX4047	84	97				
	H 72 (71,7x33,4)	1XXX405	90	101				
	H 96 (95,7x33,4)	1XXX406	103	106				
	H 120 (119,7x33,4)	1XXX407	125	127				
	H 132 (131,7x33,4)	1XXX408	132	139				
	<p>ante di finitura laterali sp. 1,8 senza gola lateral finishing doors th. 1,8 without finger rail</p> 							
BASE BASE UNIT								
H 50,5 (37,2x59,9)		1XXX3952	90	94				
H 64 (50,7x59,9)		1XXX3963	97	106				
H 76 (62,7x59,9)		1XXX3983	106	120				
H 88 (74,7x59,9)		1XXX4003	121	151				
ISOLA ISLAND								
H 76 (62,7x62,1)		1XXX4023	107	122				
H 88 (74,7x62,1)		1XXX4033	119	179				
H 88 (74,7x93,3)		1XXX4034	145	185				
COLONNA COLUMN								
H 109 (95,7x59,9)		1XXX409	136	165				
H 145 (131,7x59,9)		1XXX410	178	223				
H 217 (203,7x59,9)		1XXX411	238	335				
H 241 (227,7x59,9)		1XXX412	259	382				
<p>fianconi d'accosto sp. 7,6 N.B.: da usare a fine composizione side panels th. 7,6 Note: use only at the end of composition</p> 								
	BASE BASE UNIT							
	88x59,9	1K364881/2	166	—				
	ISOLA ISLAND							
	88x62,1	1K364883	168	—				
	88x93,3	1K364885	211	—				
	COLONNA COLUMN							
217x59,9	1K364891/2	323	—					

ANTE DI FINITURA POSTERIORI

REAR FINISHING DOORS

* Per il codice sostituire le XXX con il codice della versione corrispondente
 * Replace XXX with the concerning code version

*COD.

NECK
 MELAMI-
 NICO
 K36 LACCATO
 OPACO
 K37

ante di finitura posteriori sp.2,2

senza gola

rear finishing doors th. 2,2

without finger rail



BASE

BASE UNIT

L 45 (62,7x44,7)

1XXX4243

98

115

L 60 (62,7x59,7)

1XXX4263

107

135

L 90 (62,7x89,7)

1XXX4283

135

165

L 30 (74,7x29,7)

1XXX4303

95

113

L 40 (74,7x39,7)

1XXX4323

100

122

L 45 (74,7x44,7)

1XXX4343

105

127

L 60 (74,7x59,7)

1XXX4363

120

145

L 90 (74,7x89,7)

1XXX4403

145

197

BASE ANGOLO

CORNER BASE UNIT

L 65 (74,7x64,7)

1XXX4383

126

175

ante di finitura posteriori sp.2,2 per basi uso
 penisola-isola

con gola

rear finishing doors th. 2,2 for base units used as peninsula-
 island

with finger rail

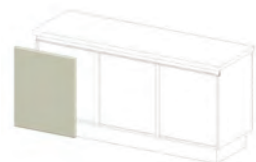

BASE

BASE UNIT

L 45 (59,7x44,7)

1XXX424

108

116

L 60 (59,7x59,7)

1XXX426

120

136

L 90 (59,7x89,7)

1XXX428

153

176

L 30 (71,7x29,7)

1XXX430

102

105

L 40 (71,7x39,7)

1XXX432

110

120

L 45 (71,7x44,7)

1XXX434

114

125

L 60 (71,7x59,7)

1XXX436

126

147

L 90 (71,7x89,7)

1XXX440

161

199

BASE ANGOLO

CORNER BASE UNIT

L 65 (71,7x64,7)



1XXX438

135

176

COPRIFIANCHI LACCATI

LACQUERED SIDE PANELS



	COD.	BRIDGE						
		MELAMI- NICO K33	LACCATO OPACO K34					
<p>coprifianco LACCATO sp.1 mm per rifinire i fianchi a vista LACQUERED side panel th. 1 mm for visible sides finishing</p> 								
	PENSILE WALL UNIT							
	36x31	T98340	—	47				
	48x31	T98345	—	48				
	60x31	T98350	—	50				
	72x31	T98355	—	54				
	96x31	T98360	—	65				
	120x31	T98365	—	78				
	132x31	T98367	—	98				
	<p>coprifianco LACCATO sp.1 mm per rifinire i fianchi a vista LACQUERED side panel th. 1 mm for visible sides finishing</p> 							
BASE BASE UNIT								
36x57,5		T98300	—	50				
48x57,5		T98305	—	63				
60x57,5		T98310	—	73				
72x57,5		T98315	—	86				
COLONNA COLUMN								
132x31		T98367	—	98				
204x31		T98375	—	130				
228x31		T98380	—	132				
96x57,5		T98320	—	92				
132x57,5		T98325	—	136				
204x57,5		T98330	—	201				
228x57,5		T98335	—	227				

ANTE DI FINITURA LATERALI

LATERAL FINISHING DOORS

* Per il codice sostituire le XXX con il codice della versione corrispondente

* Replace XXX with the concerning code version

	*COD.	BRIDGE						
		MELAMI- NICO K33	LACCATO OPACO K34					
<p>ante di finitura laterali sp. 1,8 lateral finishing doors th. 1,8</p> 								
	PENSILE WALL UNIT							
	H 36 (35,7x33,4)	1XXX4045	68	75				
	H 48 (47,7x33,4)	1XXX4046	78	86				
	H 60 (59,7x33,4)	1XXX4047	84	97				
	H 72 (71,7x33,4)	1XXX405	90	101				
	H 96 (95,7x33,4)	1XXX406	103	106				
	H 120 (119,7x33,4)	1XXX407	125	127				
	H 132 (131,7x33,4)	1XXX408	132	139				
<p>ante di finitura laterali sp. 1,8 lateral finishing doors th. 1,8</p> 								
	BASE BASE UNIT							
	H 49 (35,7x59,9)	1XXX395	89	94				
	H 61 (47,7x59,9)	1XXX396	95	103				
	H 73 (59,7x59,9)	1XXX398	103	115				
	H 85 (71,7x59,9)	1XXX400	110	125				
	ISOLA ISLAND							
	H 73 (59,7x62,1)	1XXX402	101	117				
	H 85 (71,7x62,1)	1XXX403	116	150				
	COLONNA COLUMN							
	H 109 (95,7x59,9)	1XXX409	136	165				
	H 145 (131,7x59,9)	1XXX410	178	223				
H 217 (203,7x59,9)	1XXX411	238	335					
H 241 (227,7x59,9)	1XXX412	259	382					
<p>fianconi d'accosto sp. 7,6 N.B.: da usare a fine composizione side panels th. 7,6 Note: use only at the end of composition</p> 								
	BASE BASE UNIT							
	85x59,9	1K334871/2	166	—				
	ISOLA ISLAND							
	85x62,1	1K334873	168	—				
85x93,3	1K334875	211	—					
COLONNA COLUMN								
217x59,9	1K334891/2	323	—					

ANTE DI FINITURA POSTERIORI

REAR FINISHING DOORS

* Per il codice sostituire le XXX con il codice della versione corrispondente

* Replace XXX with the concerning code version

**ante di finitura posteriori
per basi uso penisola-isola sp.2,2**
rear finishing doors th. 2,2
for base units used as peninsula-island



BASE

BASE UNIT

L 45 (59,7x44,7)

L 60 (59,7x59,7)

L 90 (59,7x89,7)

L 30 (71,7x29,7)

L 40 (71,7x39,7)

L 45 (71,7x44,7)

L 60 (71,7x59,7)

L 90 (71,7x89,7)

BASE ANGOLO

CORNER BASE UNIT

L 65 (71,7x64,7)

*COD.

BRIDGE

MELAMI-
NICO
K33



LACCATO
OPACO
K34







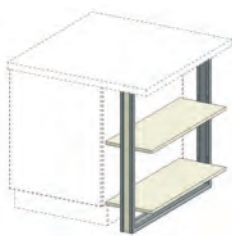

TERMINALI A GIORNO













OPEN END UNITS



		COD.	MELAMINICO	LACCATO OPACO					
 <p>terminale a giorno L 30 per base struttura in alluminio brill o titanio 2 ripiani sp.1,8 finitura come anta open end unit W 30 for base unit stainless steel structure brill or titanium 2 shelves th.1,8 same finish as door</p>	brill	P 57,5 H 85	E7870575	667	924				
		H 88	E7871575	667	924				
	titanio titanium	P 57,5 H 85	E7880575	667	924				
		H 88	E7881575	667	924				
	 <p>terminale a giorno L 30 per isola struttura in alluminio brill o titanio 2 ripiani sp.1,8 finitura come anta open end unit W 30 for island stainless steel structure brill or titanium 2 shelves th.1,8 same finish as door</p>	brill	P 88,5 H 85	E7870885	739	1.062			
			H 88	E7871885	739	1.062			
titanio titanium		P 88,5 H 85	E7880885	739	1.062				
		H 88	E7881885	739	1.062				
 <p>terminale a giorno L 30 per colonna struttura in alluminio brill o titanio 4 ripiani sp.1,8 finitura come anta open end unit W 30 for column stainless steel structure brill or titanium 4 shelves th.1,8 same finish as door</p>		brill	P 57,5 H 145	E7873575	814	1.180			
			titanio titanium	P 57,5 H 145	E7883575	814	1.180		

		COD.	MELAMINICO					
 <p>elemento L 90 H 36 con 2 vani unit W 90 H 36 with 2 compartments</p>	L 90 H 36	E7700225	380					
 <p>elemento L 90 H 48 con 3 vani unit W 90 H 48 with 3 compartments</p>	L 90 H 48	E7700245	427					
 <p>elemento L 90 H 60 con 5 vani unit W 90 H 60 with 5 compartments</p>	L 90 H 60	E7700260	503					
 <p>elemento L 120 H 36 con 3 vani unit W 120 H 36 with 3 compartments</p>	L 120 H 36	E7700230	442					
 <p>elemento L 120 H 48 con 5 vani unit W 120 H 48 with 5 compartments</p>	L 120 H 48	E7700250	516					
 <p>elemento L 120 H 60 con 6 vani unit W 120 H 60 with 6 compartments</p>	L 120 H 60	E7700265	583					
 <p>elemento L 180 H 36 con 4 vani unit W 180 H 36 with 4 compartments</p>	L 180 H 36	E7700235	594					













ELEMENTI A GIORNO OPEN UNITS

		COD.	MELAMI-NICO	LACCATO OPACO	DECORO			
 <p>base H 18 1 cassetto base unit H 18 1 drawer</p>		L 60	EBA13600	205	193	—		
		L 90	EBA13900	243	228	—		
 <p>base H 24 1 cassetto base unit H 24 1 drawer</p>		L 45	EBA23450	198	192	—		
		L 60	EBA23600	221	214	—		
		L 90	EBA23900	260	258	—		
 <p>base H 36 2 cassetti H 18 base unit H 36 2 drawers H 18</p>		L 60	EBA33600	343	320	—		
		L 90	EBA33900	408	380	—		
 <p>base H 36 1 cestone base unit H 36 1 deep drawer</p>		L 45	EBA35450	222	232	—		
		L 60	EBA35600	247	252	—		
 <p>base H 48 1 cestone base unit H 48 1 deep drawer</p>		L 45	EBA45450	226	229	—		
 <p>base H 36 1 anta base unit H 36 1 door</p>		L 45	EBA31451/2	173	182	—		
		L 60	EBA31601/2	197	201	—		

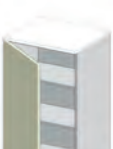





MOBILI IN APPOGGIO PER LIVING

H 48 - 72 - 96 - 120 - 132 P 50,4

LIVING RESTING FURNITURE



			COD.	MELAMINICO	LACCATO OPACO	DECORO			
 <p>base H 48 1 anta base unit H 48 1 door</p>		L 45	EBA41451/2	195	198	319			
 <p>base H 72 1 anta base unit H 72 1 door</p>		L 45	EBA61451/2	207	212	—			
		L 60	EBA61601/2	213	227	—			
 <p>base H 72 1 cassetto H 12 apertura TIP-ON 1 anta H 60 apertura push-pull N.B.: per la versione Decoro il cassetto viene realizzato melaminico o laccato base unit H 72 1 drawer H 12 TIP-ON opening 1 door H 60 push-pull opening Note: drawer realized in melamine or lacquered for Decor version</p>		L 60	EBA62601/2	342	352	573			
 <p>colonna H 96 1 anta column H 96 1 door</p>		L 45	EBA71451/2	288	294	—			
		L 60	EBA71601/2	298	310	—			
 <p>colonna H 120 2 ante H 60 column H 120 2 doors H 60</p>		L 45	EBA81451/2	399	406	—			
		L 60	EBA81601/2	406	427	891			
 <p>colonna H 132 1 anta superiore H 60 apertura push-pull 1 cassetto centrale H 12 apertura TIP-ON 1 anta inferiore H 60 apertura push-pull N.B.: per la versione Decoro il cassetto viene realizzato melaminico o laccato column H 132 1 upper door H 60 push-pull opening 1 central drawer H 12 TIP-ON opening 1 lower door H 60 push-pull opening Note: drawer realized in melamine or lacquered for Decor version</p>		L 60	EBA92601/2	560	587	1.030			

MOBILI IN APPOGGIO RESTING FURNITURES

ante apertura push-pull doors with push-pull opening	COD.	VETRO TELAIO ALLUM.					
 <p>base H 48 1 anta base unit H 48 1 door</p>	L 45	EBA41461/2	229				
 <p>base H 72 1 anta base unit H 72 1 door</p>	L 45	EBA61461/2	251				
	L 60	EBA61611/2	270				
 <p>base H 72 1 cassetto H 12 apertura TIP-ON 1 anta H 60 N.B.: per la versione Vetro il cassetto viene realizzato melaminico o laccato base unit H 72 1 drawer H 12 TIP-ON opening 1 door H 60 Note: drawer realized in melamine or lacquered for Glass version</p>	L 60	EBA62611/2	394				
 <p>colonna H 96 1 anta column H 96 1 door</p>	L 45	EBA71461/2	345				
	L 60	EBA71611/2	361				
 <p>colonna H 120 2 ante H 60 column H 120 2 doors H 60</p>	L 60	EBA81611/2	508				
 <p>colonna H 132 1 anta superiore H 60 1 cassetto centrale H 12 apertura TIP-ON 1 anta inferiore H 60 N.B.: per la versione Vetro il cassetto viene realizzato melaminico o laccato column H 132 1 upper door H 60 1 central drawer H 12 TIP-ON opening 1 lower door H 60 Note: drawer realized in melamine or lacquered for Glass version</p>	L 60	EBA92611/2	648				

MOBILI IN APPOGGIO PER LIVING

LIVING RESTING FURNITURE

	COD.	MELAMINICO	LACCATO OPACO	DECORO				
<p>top living come anta H 1,8 P 50,4 al ml living worktop same finish as door H 1,8 D 50,4 per lm</p> 								
	<p>melaminico L max 275 melamine</p> <p>laccato L max 310 lacquered</p>	TLE187	68	—	—			
<p>fianco living P 50,4 sp.1,8 al ml lateral finish panel for living base unit D 50,4 th.1,8 per lm</p> 								
	<p>melaminico melamine</p> <p>laccato lacquered</p>	TLE187F	68	—	—			
<p>basamento in ferro finitura brill o titanio, inserti finitura come anta melaminico o laccato H 13 P 48 iron basament in brill or titanium finishing with melamine or lacquered insert, same colour as door H 13 D 48</p>  <p>inserto finitura come anta insert same finish as door</p>								
	brill							
	L 74	T92530	647	647	—			
	L 104	T92531	745	745	—			
	L 134	T92532	843	843	—			
	L 164	T92533	925	925	—			
	titanio titanium							
	L 74	T92535	647	647	—			
	L 104	T92536	745	745	—			
	L 134	T92537	843	843	—			
L 164	T92538	925	925	—				





LIVING

Spazi coordinati per avere un solo ambiente per cucinare, ricevere gli amici, pranzare e rilassarsi è una soluzione al desiderio di vivere la casa più liberamente, secondo stili di vita contemporanei, integrando cucina e living all'insegna di un nuovo linguaggio progettuale.

Coordinated spaces that create a single environment in which to cook, receive friends and relax is a solution that allows you to experience the home more freely.

In line with contemporary lifestyles, this solution integrates the kitchen and living area to create a new design language















Per la modulistica completa dei pensili P 33,4 consultare la sezione "Pensili" For complete modularity of wall units D 33,4 see "Wall units" section		COD.	MELAMINICO	LACCATO OPACO	DECORO			
 <p>pensile H 36 apertura a vasistas con push-pull (opz.996) wall unit H 36 flap door with push-pull opening (code 996)</p>	L 60	E/G2106600	204	211	325			
	L 90	E/G2106900	296	295	491			
 <p>pensile H 48 apertura a vasistas con push-pull (opz.996) wall unit H 48 flap door with push-pull opening (code 996)</p>	L 60	E/G2123600	286	292	498			
	L 90	E/G2123900	325	331	639			
 <p>mensola in appoggio per pensile finitura come anta support shelf for wall unit same finish as door</p>								
 <p>maggiorazione per fianchi di struttura come anta (cadauno) surcharge for carcass sides same finish as door (each)</p>								
 <p>coprifianco LACCATO sp.1 mm per rifinire i fianchi a vista LACQUERED side panel th.1 mm for visible sides finishing</p>								

BASI LIVING con piedi cromati H 2

H 22,2 - 39,5 - 53 P 50,4

LIVING AREA BASE UNITS with chromed feet H 2







Le basi non sono comprensive di top - N.B.: cerniere ammortizzate di serie The base units do not include the tops - Note: standard blumotion hinges		COD.	MELAMI- NICO	LACCATO OPACO				
			K36	K37				
 <p>base H 22,2 1 cassetto H 16,9 base unit H 22,2 1 drawer H 16,9</p>	L 45	GBL03450	207	203				
	L 60	GBL03600	231	219				
	L 90	GBL03900	270	255				
 <p>base H 39,5 1 anta H 34,2 base unit H 39,5 1 door H 34,2</p>	L 45	GBL21451/2	189	202				
	L 60	GBL21601/2	204	205				
 <p>base H 39,5 2 ante H 34,2 base unit H 39,5 2 doors H 34,2</p>	L 90	GBL21900	307	336				
	L 120	GBL22200	350	352				
 <p>base H 39,5 1 cestone H 34,2 base unit H 39,5 1 deep drawer H 34,2</p>	L 45	GBL25450	234	247				
	L 60	GBL25600	261	262				
	L 90	GBL25900	310	307				
 <p>base H 39,5 2 cassetti H 16,9 base unit H 39,5 2 drawers H 16,9</p>	L 45	GBL23450	307	301				
	L 60	GBL23600	350	327				
	L 90	GBL23900	411	384				
 <p>base H 53 1 anta H 47,7 base unit H 53 1 door H 47,7</p>	L 45	GBL31451/2	208	212				
	L 60	GBL31601/2	219	223				







Le basi non sono comprensive di top - N.B.: cerniere ammortizzate di serie The base units do not include the tops - Note: standard blumotion hinges		COD.	MELAMI-NICO	LACCATO OPACO				
			K36	K37				
 <p>base H 37,5 1 anta H 34,2 base unit H 37,5 1 door H 34,2</p>	L 45	GBL71451/2	190	203				
	L 60	GBL71601/2	208	209				
 <p>base H 37,5 2 ante H 34,2 base unit H 37,5 2 doors H 34,2</p>	L 90	GBL71900	304	333				
	L 120	GBL72200	349	351				
 <p>base H 37,5 1 cestone H 34,2 base H 37,5 1 deep drawer H 34,2</p>	L 45	GBL75450	237	250				
	L 60	GBL75600	259	260				
	L 90	GBL75900	312	309				
 <p>base H 51 1 anta H 47,7 base unit H 51 1 door H 47,7</p>	L 45	GBL81451/2	210	213				
	L 60	GBL81601/2	218	223				
 <p>base H 51 2 ante H 47,7 base unit H 51 2 doors H 47,7</p>	L 90	GBL81900	316	326				
	L 120	GBL82200	368	376				
 <p>base H 51 1 cestone H 47,7 base unit H 51 1 deep drawer H 47,7</p>	L 45	GBL85450	241	244				
	L 60	GBL85600	265	269				
	L 90	GBL85900	324	328				

BASI LIVING CON ZOCCOLO

H 33,2 - 50,5 - 64 P 59,9

LIVING AREA BASE UNITS WITH PLINTH







Le basi non sono comprensive di top - N.B.: cassetti e cestoni ad estrazione totale con blumotion The base units do not include the tops - Note: fully extending drawers and deep drawers with blumotion system		COD.	MELAMI- NICO	LACCATO OPACO					
			K36	K37					
 <p>base H 33,2 1 cassetto H 16,9 base unit H 33,2 1 drawer H 16,9</p>	L 45	G4203450	187	186					
	L 60	G4203600	216	206					
	L 90	G4203900	262	249					
 <p>base H 50,5 1 anta H 34,2 base unit H 50,5 1 door H 34,2</p>	L 45	G4026451/2	192	208					
	L 60	G4026601/2	218	221					
 <p>base H 50,5 2 ante H 34,2 base unit H 50,5 2 doors H 34,2</p>	L 90	G4026900	319	351					
	L 120	G4027200	366	372					
 <p>base H 50,5 1 cestone H 34,2 base unit H 50,5 1 deep drawer H 34,2</p>	L 45	G4204450	223	239					
	L 60	G4204600	250	253					
	L 90	G4204900	303	302					
 <p>base H 50,5 2 cassetti H 16,9 base unit H 50,5 2 drawers H 16,9</p>	L 45	G4204460	303	300					
	L 60	G4204610	347	327					
	L 90	G4204910	414	389					
 <p>base H 64 1 anta H 47,7 base unit H 64 1 door H 47,7</p>	L 45	G4028451/2	196	202					
	L 60	G4028601/2	224	230					

Le basi non sono comprensive di top - N.B.: cerniere ammortizzate di serie The base units do not include the tops - Note: standard blumotion hinges		COD.	MELAMI- NICO K33	LACCATO OPACO K34					
 <p>base H 20 1 cassetto H 18 base unit H 20 1 drawer H 18</p>	L 45	EBL03450	185	181					
	L 60	EBL03600	210	198					
	L 90	EBL03900	260	236					
	 <p>base H 26 1 cassetto H 24 base unit H 26 1 drawer H 24</p>	L 45	EBL13450	199	193				
L 60		EBL13600	225	218					
L 90		EBL13900	267	265					
 <p>base H 38 1 anta H 36 base unit H 38 1 door H 36</p>		L 45	EBL21451/2	180	189				
	L 60	EBL21601/2	199	203					
	 <p>base H 38 2 ante H 36 base unit H 38 2 doors H 36</p>	L 90	EBL21900	298	320				
L 120		EBL22200	344	353					
 <p>base H 38 1 cestone H 36 base unit H 38 1 deep drawer H 36</p>		L 45	EBL25450	227	237				
	L 60	EBL25600	251	255					
	L 90	EBL25900	292	289					
 <p>base H 38 2 cassetti H 18 base unit H 38 2 drawers H 18</p>	L 45	EBL23450	307	301					
	L 60	EBL23600	347	324					
	L 90	EBL23900	407	379					







BASI LIVING con piedi cromati H 2







H 50 P 50,4

LIVING AREA BASE UNITS with chromed feet H 2

Le basi non sono comprensive di top - N.B.: cerniere ammortizzate di serie The base units do not include the tops - Note: standard blumotion hinges		COD.	MELAMINICO	LACCATO					
			K33	OPACO					
 <p>base H 50 1 anta H 48 base unit H 50 1 door H 48</p>	L 45	EBL31451/2	202	205					
	L 60	EBL31601/2	209	213					
 <p>base H 50 2 ante H 48 base unit H 50 2 doors H 48</p>	L 90	EBL31900	309	318					
	L 120	EBL32200	355	363					
 <p>base H 50 1 cestone H 48 base unit H 50 1 deep drawer H 48</p>	L 45	EBL35450	231	235					
	L 60	EBL35600	257	261					
	L 90	EBL35900	304	307					
 <p>top living H 1,8 P 50,4 living worktop H 1,8 D 50,4</p>									
		P 50,4 sp.1,8 al ml D 50,4 th.1,8 per lm melaminico L max 270 melamine laccato L max 310 lacquered	TLE187	68	—				
			TLC187	—	181				
 <p>maggiorazione per fianchi di struttura come anta (cadauno) surcharge for carcass sides same finish as door (each)</p>									
		BASI							
		BASE UNITS							
		18X48		+30	—				
		26X48		+30	—				
	36X48		+30	—					
	48X48		+33	—					
 <p>fianco living lateral finish panel for living base unit</p>									
		laccato lacquered P 50,4 sp.1,8 al ml D 50,4 th.1,8 per ml	TLC187F	—	181				

Le basi non sono comprensive di top - N.B.: cerniere ammortizzate di serie
 The base units do not include the tops - Note: standard blumotion hinges

		COD.	MELAMINICO K33	LACCATO OPACO K34					
 <p>base H 36 1 ante base unit H 36 1 door</p>	L 45	EBL71451/2	181	191					
	L 60	EBL71601/2	203	207					
 <p>base H 36 2 ante base unit H 36 2 doors</p>	L 90	EBL71900	288	310					
	L 120	EBL72200	331	340					
 <p>base H 36 1 cestone base H 36 1 deep drawer</p>	L 45	EBL75450	230	240					
	L 60	EBL75600	253	258					
	L 90	EBL75900	294	292					
 <p>base H 48 1 ante base unit H 48 1 door</p>	L 45	EBL81451/2	203	207					
	L 60	EBL81601/2	213	217					
 <p>base H 48 2 ante base unit H 48 2 doors</p>	L 90	EBL81900	305	315					
	L 120	EBL82200	349	358					
 <p>base H 48 1 cestone base unit H 48 1 deep drawer</p>	L 45	EBL85450	234	238					
	L 60	EBL85600	260	264					
	L 90	EBL85900	307	310					

Le basi non sono comprensive di top - N.B.: cassetti e cestoni ad estrazione totale con blumotion The base units do not include the tops - Note: fully extending drawers and deep drawers with blumotion system		COD.	MELAMI-NICO	LACCATO OPACO					
			K33	K34					
 <p>base H 31 1 cassetto H 18 base unit H 31 1 drawer H 18</p>	L 45	E4023450	173	171					
	L 60	E4023600	198	187					
	L 90	E4023900	245	232					
 <p>base H 37 1 cassetto H 24 base unit H 37 1 drawer H 24</p>	L 45	E4025450	181	178					
	L 60	E4025600	210	206					
	L 90	E4025900	260	260					
 <p>base H 49 1 anta H 36 base unit H 49 1 door H 36</p>	L 45	E4026451/2	159	175					
	L 60	E4026601/2	178	191					
 <p>base H 49 2 ante H 36 base unit H 49 2 doors H 36</p>	L 90	E4026900	284	315					
	L 120	E4027200	329	336					
 <p>base H 49 1 cestone H 36 base unit H 49 1 deep drawer H 36</p>	L 45	E4204450	193	209					
	L 60	E4204600	213	217					
	L 90	E4204900	265	265					
 <p>base H 49 2 cassetti H 18 base unit H 49 2 drawers H 18</p>	L 45	E4204460	270	267					
	L 60	E4204610	307	286					
	L 90	E4204910	371	346					

LIVING KRW-1



ANTE
doors



FRASSINO CRETA
clay ash



LACCATO CUOIO
OPACO
matt lacquered
leather

ELEMENTI A GIORNO
open units



ROSSO TOSCANO
tuscan red

STRUTTURE
carcasses

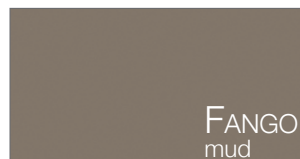

FANGO
mud

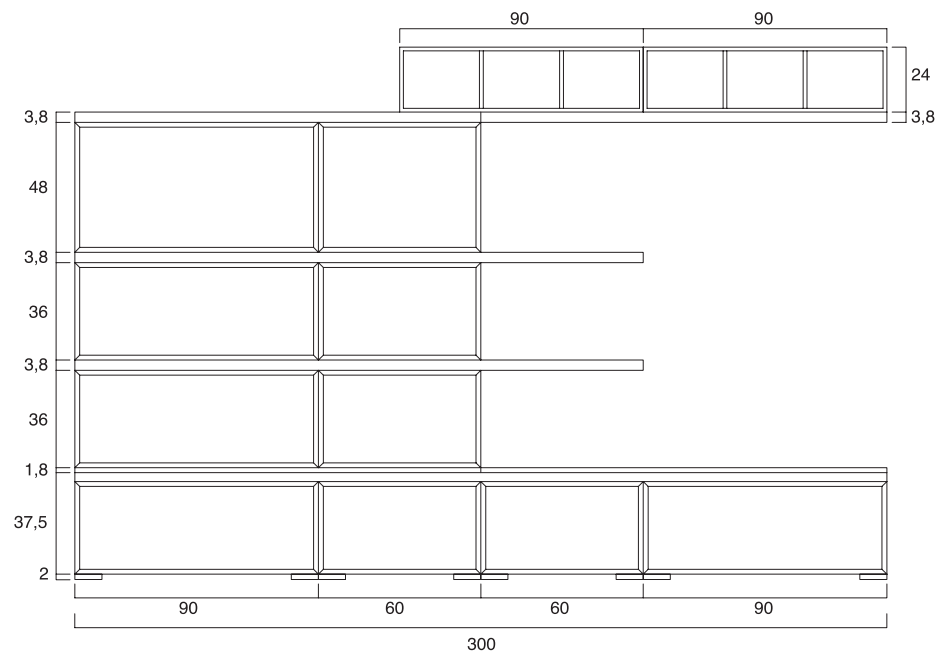

NR. ELEMENTI	DESCRIZIONE	CODICE	€ cad.
1	Pensile L 90 H 48 P 33,4 ribalta apertura tip-on	G212091T	247
1	Pensile L 60 H 48 P 33,4 ribalta apertura tip-on	G212061T	208
1	Coprifianco H 48 P 31 laccato come anta	T98345	48
2	Pensile L 90 H 36 P 33,4 apertura vasistas	G2106900	295
2	Pensile L 60 H 36 P 33,4 apertura vasistas	G2106600	211
2	Coprifianco H 36 P 31 laccato come anta	T98340	47
1	Base living L 90 H 39,5 P 50,4, 1 cestone	GBL25900	310
2	Base living L 60 H 39,5 P 50,4, 1 cestone	GBL25600	261
1	Base living L 90 H 39,5 P 50,4, 1 cestone, 1 fianco come anta	GBL25900	340
2	Elemento a giorno L 90 H 24 P 31, 3 vani laccato opaco	E7701707	270
2	Mensola melaminico L 150 P 33,4 SP. 3,8 colore come anta	al ml 091527	92
2	Mensola melaminico L 210 P 33,4 SP. 3,8 colore come anta	al ml 091527	92
2	Top melaminico L 150 P 50,4 SP. 1,8 colore come anta	al ml TLE187	68
3	Asta appendipensili ml 2	08610501	9
TOTALE			4.215

No. of ELEMENTS	DESCRIPTION	CODE	€ each
1	Wall unit W 90 H 48 D 33,4 flap door, tip-on opening	G212091T	247
1	Wall unit W 60 H 48 D 33,4 flap door, tip-on opening	G212061T	208
1	Lacquered side panel H 48 D 31 same colour as door	T98345	48
2	Wall unit W 90 H 36 D 33,4 flap door opening	G2106900	295
2	Wall unit W 60 H 36 D 33,4 flap door opening	G2106600	211
2	Lacquered side panel H 36 D 31 same colour as door	T98340	47
1	Living base unit W 90 H 39,5 D 50,4, 1 deep drawer	GBL25900	310
2	Living base unit W 60 H 39,5 D 50,4, 1 deep drawer	GBL25600	261
1	Living base unit W 90 H 39,5 D 50,4, 1 deep drawer, 1 side same as door	GBL25900	340
2	Matt lacquered open unit W 90 H 24 D 31, 3 compartments	E7701707	270
2	Melamine shelf W 150 D 33,4 TH. 3,8 same colour as door	per lm 091527	92
2	Melamine shelf W 210 D 33,4 TH. 3,8 same colour as door	per lm 091527	92
2	Melamine worktop W 150 D 50,4 TH. 1,8 same colour as door	per lm TLE187	68
3	Wall unit fixing strip 1m 2	per lm 08610501	9
TOTAL			4.215

LIVING KRW-2



ANTE
doors

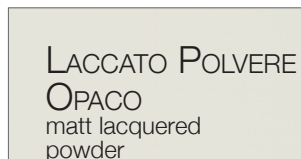

ANTA VETRO
glass door

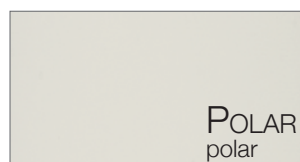

STRUTTURE
carcasses

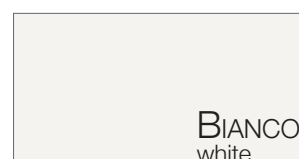

LIVING KRW-2

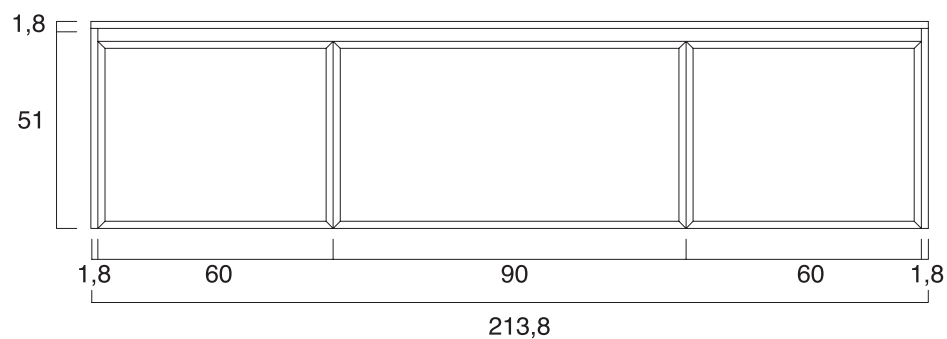
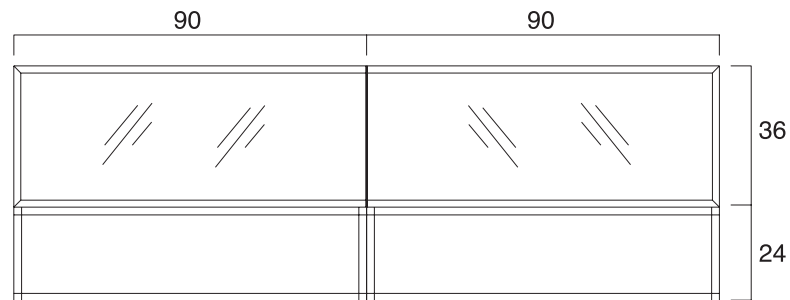

NR. ELEMENTI	DESCRIZIONE	CODICE	€ cad.
2	Pensile vetro telaio alluminio L 90 H 36 P 33,4 ribalta tip-on, fianco come anta	G110291T	281
2	Elemento a giorno alluminio L 90 H 24 P 31, ripiani in vetro	E7861090	298
2	Base living sospesa L 60 H 51 P 50,4 1 cestone	GBL85600	265
1	Base living sospesa L 90 H 51 P 50,4 1 cestone	GBL85900	328
1	Top melaminico L 213,8 P 50,4 SP. 1,8 colore come anta	al ml TLE187	68
2	Fianco melaminico H 51 P 50,4 SP. 1,8 colore come anta	al ml TLE187F	68
2	Asta appendipensili ml 2	08610501	9
TOTALE			2.249

No. of ELEMENTS	DESCRIPTION	CODE	€ each
2	Glass door wall unit with aluminium frame W 90 H 36 D 33,4, flap door with tip-on opening, side same as door	G110291T	281
2	Aluminium open element W 90 H 24 D 31 with glass shelves	E7861090	298
2	Hanging living base unit W 60 H 51 D 50,4 1 deep drawer	GBL85600	265
1	Hanging living base unit W 90 H 51 D 50,4 1 deep drawer	GBL85900	328
1	Melamine worktop W 213,8 D 50,4 TH. 1,8 same colour as door	per lm TLE187	68
2	Melamine side panel H 51 D 50,4 TH. 1,8 same colour as door	per lm TLE187F	68
2	Wall unit fixing strip mt. 2	08610501	9
TOTAL			2.249

LIVING KRW-3



ANTA
door

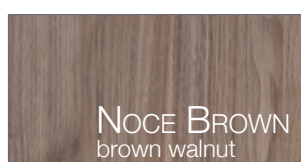

ANTA VETRO
glass door

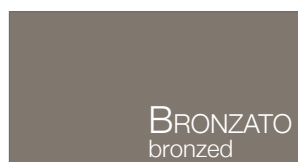

ELEMENTI A GIORNO
open units



STRUTTURE
carcasses

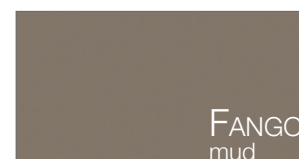

LIVING KRW-4



ANTA
door

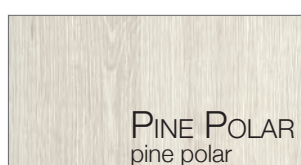

ELEMENTI A GIORNO
open units



STRUTTURE
carcasses



LIVING KRW-4

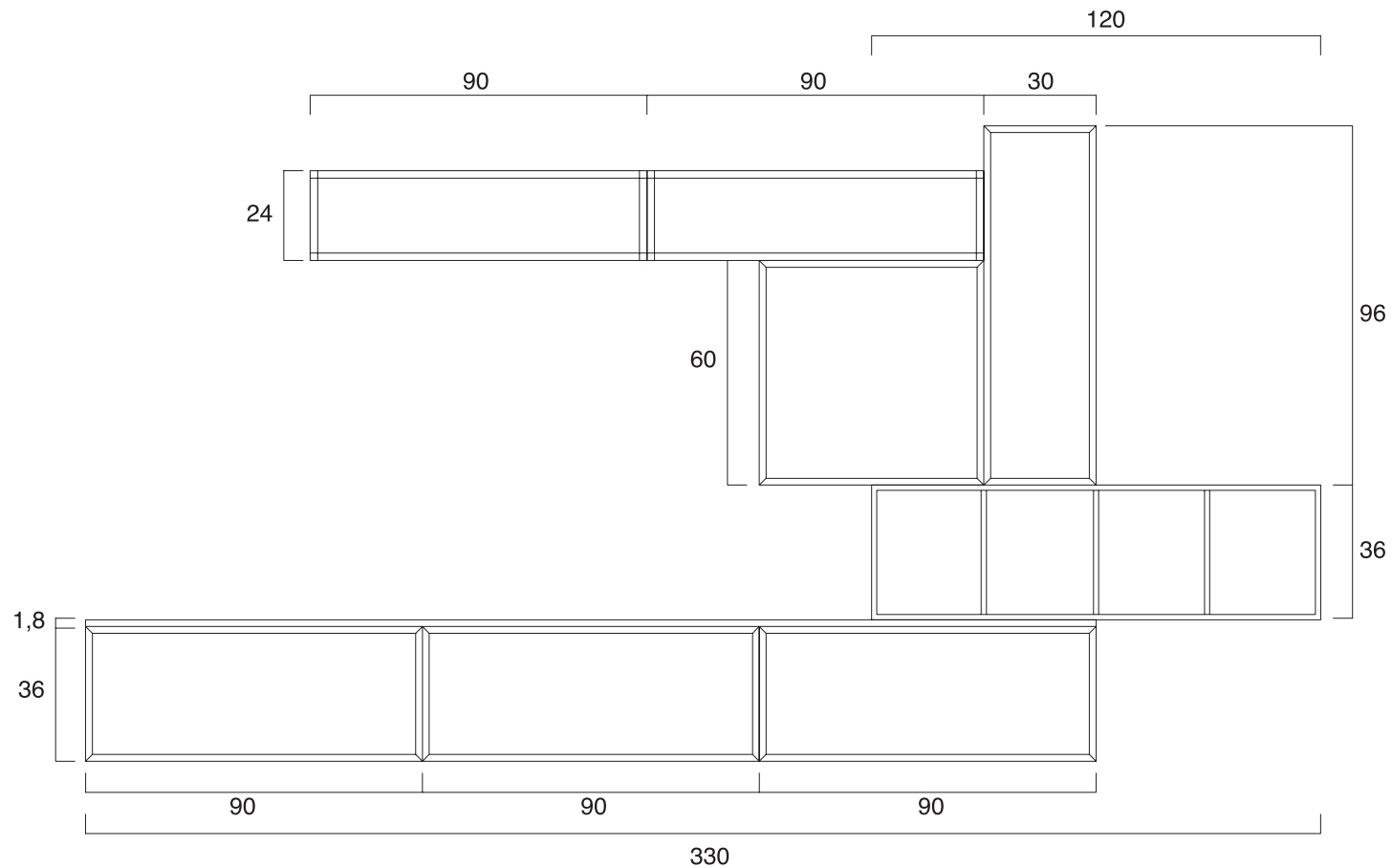

NR. ELEMENTI	DESCRIZIONE	CODICE	€ cad.
2	Elemento a giorno alluminio L 90 H 24 P 31, ripiani in vetro	E7861090	298
1	Pensile L 60 H 60 P 33,4 apertura push-pull, 1 fianco come anta	E2060601/2	214
1	Pensile L 30 H 96 P 33,4 apertura push-pull, 2 fianchi come anta	E2020301/2	270
1	Elemento a giorno L 120 H 36 P 31, 4 vani, laccato opaco	E7701713	386
2	Base living sospesa L 90 H 36 P 50,4, 1 cestone apertura tip-on, 1 fianco come anta	EBL75900	369
1	Base living sospesa L 90 H 36 P 50,4, 1 cestone apertura tip-on	EBL75900	339
1	Top melaminico L 270 P 50,4 SP. 1,8 colore come anta	al ml TLE187	68
2	Asta appendipensili ml 2	08610501	9
TOTALE			2.745
No. of ELEMENTS	DESCRIPTION	CODE	€ each
2	Aluminium open element W 90 H 24 D 31 with glass shelves	E7861090	298
1	Wall unit W 60 H 60 D 33,4 push-pull opening, 1 side same colour as door	E2060601/2	214
1	Wall unit W 30 H 96 D 33,4 push-pull opening, 2 sides same colour as door	E2020301/2	270
1	Matt lacquered open element W 120 H 36 D 31, 4 compartments	E7701713	386
2	Hanging living base unit W 90 H 36 D 50,4, 1 deep drawer tip-on opening, 1 side same colour as door	EBL75900	369
1	Hanging living base unit W 90 H 36 D 50,4, 1 deep drawer tip-on opening	EBL75900	339
1	Melamine worktop W 270 D 50,4 TH. 1,8 same colour as door	per lm TLE187	68
2	Wall unit fixing strip lm 2	08610501	9
TOTAL			2.745

LIVING KRW-5



ANTA
door



ANTA VETRO
glass door

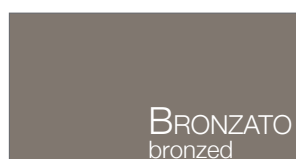

ELEMENTI A GIORNO
open units



STRUTTURA
carcass

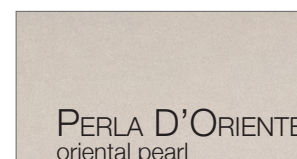

LIVING KRW-5

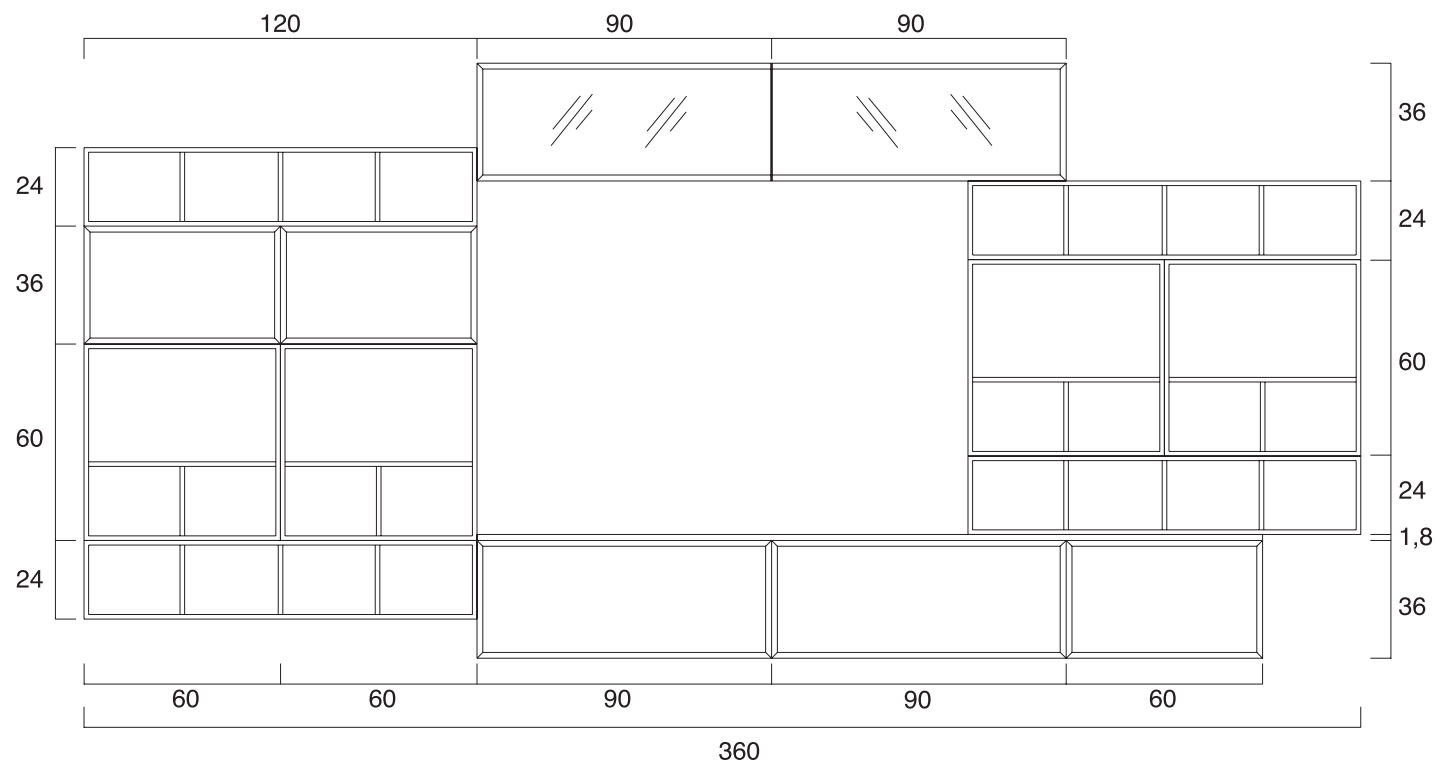

NR. ELEMENTI	DESCRIZIONE	CODICE	€ cad.
2	Pensile vetro telaio alluminio L 90 H 36 P 33,4 ribalta tip-on, 1 fianco come anta	G110291T	281
2	Pensile L 60 H 36 P 33,4 ribalta tip-on, 1 fianco come anta	G210061T	197
4	Elemento a giorno L 120 H 24 P 31, 4 vani, laccato opaco	E7701708	339
4	Elemento a giorno L 60 H 60 P 31, 3 vani, laccato opaco	E7701720	314
1	Base living sospesa L 90 H 36 P 50,4, 1 cestone apertura tip-on, 1 fianco come anta	EBL75900	369
1	Base living sospesa L 90 H 36 P 50,4, 1 cestone apertura tip-on	EBL75900	339
1	Base living sospesa L 60 H 36 P 50,4, 1 cestone apertura tip-on, 1 fianco come anta	EBL75600	328
1	Top melaminico L 240 P 50,4 SP. 1,8 colore come anta	al ml TLE187	68
2	Asta appendipensili ml 2	08610501	9
TOTALE			4.786
No. of ELEMENTS	DESCRIPTION	CODE	€ each
2	Glass door wall unit with aluminium frame W 90 H 36 D 33,4, flap door tip-on opening, 1 side same colour as door	G110291T	281
2	Wall unit W 60 H 36 D 33,4, flap door tip-on opening, 1 side same colour as door	G210061T	197
4	Matt lacquered open unit W 120 H 24 D 31, 4 compartments	E7701708	339
4	Matt lacquered open unit W 60 H 60 D 31, 3 compartments	E7701720	314
1	Hanging living base unit W 90 H 36 D 50,4, 1 deep drawer tip-on opening, side same colour as door	EBL75900	369
1	Hanging living base unit W 90 H 36 D 50,4, 1 deep drawer tip-on opening	EBL75900	339
1	Hanging living base unit W 60 H 36 D 50,4, 1 deep drawer tip-on opening, side same colour as door	EBL75600	328
1	Melamine worktop W 240 D 50,4 TH. 1,8 same colour as door	per lm TLE187	68
2	Wall unit fixing strip lm 2	08610501	9
TOTAL			4.786

LIVING KRW-6



ANTA
door



ANTATA DECORO
decor door



ELEMENTI A GIORNO
open units



STRUTTURA
carcass



LIVING KRW-6

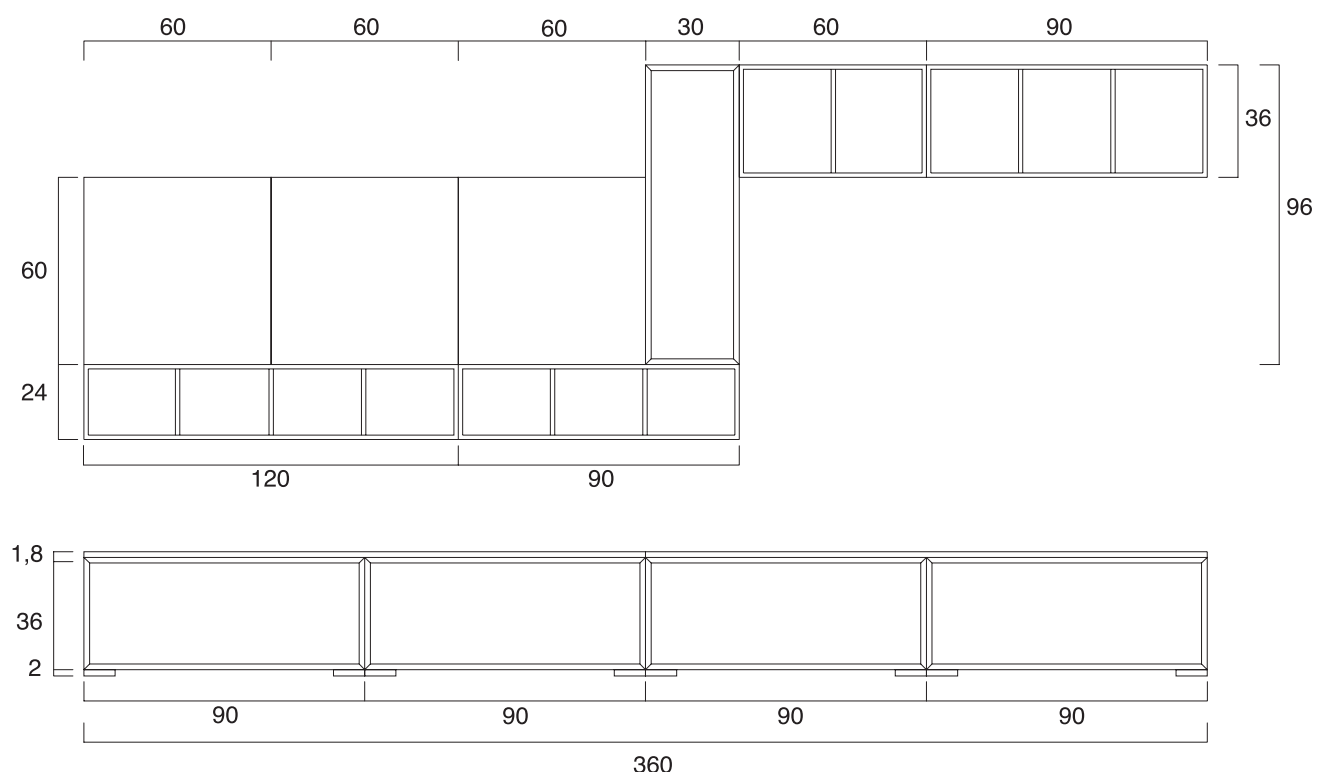

NR. ELEMENTI	DESCRIZIONE	CODICE	€ cad.
3	Pensile L 60 H 60 P 33,4, apertura push-pull	G2060601/2	408
1	Coprifianco H 60 P 31, laccato opaco	T98350	50
1	Pensile L 30 H 96 P 33,4, apertura push-pull, 2 fianchi come anta	E2020301/2	270
1	Elemento a giorno L 60 H 36 P 31, 2 vani, laccato opaco	E7701711	238
1	Elemento a giorno L 90 H 36 P 31, 3 vani, laccato opaco	E7701712	307
1	Elemento a giorno L 120 H 24 P 31, 4 vani, laccato opaco	E7701708	339
1	Elemento a giorno L 90 H 24 P 31, 3 vani, laccato opaco	E7701707	270
2	Base living L 90 H 38 P 50,4, 1 cestone apertura tip-on, 1 fianco come anta	EBL25900	367
2	Base living L 90 H 38 P 50,4, 1 cestone apertura tip-on	EBL25900	337
2	Top melaminico L 180 P 50,4 SP. 1,8 colore come anta	al ml TLE187	68
2	Asta appendipensili ml 2	08610501	9
TOTALE			4.369

No. of ELEMENTS	DESCRIPTION	CODE	€ each
3	Wall unit W 60 H 60 D 33,4, push-pull opening	G2060601/2	408
1	Matt lacquered side panel W 60 D 31	T98350	50
1	Wall unit W 30 H 96 D 33,4, push-pull opening, 2 sides same colour as door	E2020301/2	270
1	Matt lacquered open unit W 60 H 36 D 31, 2 compartments	E7701711	238
1	Matt lacquered open unit W 90 H 36 D 31, 3 compartments	E7701712	307
1	Matt lacquered open unit W 120 H 24 D 31, 4 compartments	E7701708	339
1	Matt lacquered open unit W 90 H 24 D 31, 3 compartments	E7701707	270
2	Hanging living base unit W 90 H 38 D 50,4, 1 deep drawer tip-on opening, 1 side same colour as door	EBL25900	367
2	Hanging living base unit W 90 H 38 D 50,4, 1 deep drawer tip-on opening	EBL25900	337
2	Melamine worktop W 180 D 50,4 TH. 1,8 same colour as door	per lm TLE187	68
2	Wall unit fixing strip lm 2	08610501	9
TOTAL			4.369

COMPOSIZIONE BASSA L 255 (con gola L 260)

LOW COMPOSITION W 255 (with finger rail W 260)



COMPOSIZIONE BASSA L 300 (con gola L 305)

LOW COMPOSITION W 300 (with finger rail W 305)



COMPOSIZIONE BASSA L 255 (con gola L 260)

LOW COMPOSITION W 255 (with finger rail W 260)

(IVA e contributo RAEE esclusi)

(VAT and WEEE fee excluded)

COMPONENTI COMPONENTS

Colonna 60 frigo-freezer 230 classe A+

60 cm column fridge-freezer 230 class "A+"

Base 45 2 cassetti e cestone

45 cm base unit with 2 drawers and deep drawer

Base 60 forno statico nero con ventilazione tangenziale di raffreddamento

static oven with orbital cooling ventilation 60 base unit

Piano cottura 60 4 gas inox con valvola di sicurezza

60 cm stainless steel hob with 4 gas burners with safety valve

Sottolavello 90

90 cm sink unit

Lavello ad incasso 86 x 50 1 vasca inox prelucidato

86x50 cm built-in sink with 1 stainless steel bowl

Pensile 45 H 72

45 cm wall unit H 72

Cappa 60 aspirante estraibile H 63 2 motori

60 cm hood slide-out ducting H 63 2 motors

Scolapiatti 90 H 72

90 cm plate rack H 72

Top 195 P 61 in laminato H 4

195 cm laminate worktop D 61 H 4

Asta appendipensili ml 2

2 lm wall unit fixing strip

(Elettrodomestici Indesit)
(Indesit appliances)

versioni REΣIND BRIDGE versions

MELAMINICO

€ 3.733

LACCATO

€ 3.781

versioni REΣIND NECK versions

MELAMINICO

€ 4.258

LACCATO

€ 4.421

Maggiorazione per forno statico inox
surcharges for stainless steel static oven

+ € 63

COMPOSIZIONE BASSA L 300 (con gola L 305)

LOW COMPOSITION W 300 (with finger rail W 305)

(IVA e contributo RAEE esclusi)

(VAT and WEEE fee excluded)

COMPONENTI COMPONENTS

Colonna 60 frigo-freezer 230 classe A+

60 cm column fridge-freezer 230 class "A+"

Base 60 2 cassetti e cestone

60 cm base unit with 2 drawers and deep drawer

Base 60 forno statico nero con ventilazione tangenziale di raffreddamento

static oven with orbital cooling ventilation 60 base unit

Piano cottura 60 4 gas inox con valvola di sicurezza

60 cm stainless steel hob with 4 gas burners with safety valve

Base 60

60 cm base unit

Sottolavello 60

60 cm sink unit

Lavello ad incasso 86 x 50 1 vasca inox prelucidato

86x50 cm built-in sink with 1 stainless steel bowl

Pensile 60 H 72

60 cm wall unit H 72

Cappa 60 aspirante estraibile H 63 2 motori

60 cm hood slide-out ducting H 63 2 motors

Pensile 60 H 72

60 cm wall unit H 72

Scolapiatti 60 H 72

60 cm plate rack H 72

Top 240 P 61 in laminato H 4

240 cm laminate worktop D 61 H 4

Asta appendipensili ml 4

4 lm wall unit fixing strip

(Elettrodomestici Indesit)
(Indesit appliances)

versioni REΣIND BRIDGE versions

MELAMINICO

€ 3.998

LACCATO

€ 4.059

versioni REΣIND NECK versions

MELAMINICO

€ 4.561

LACCATO

€ 4.735

Maggiorazione per forno statico inox
surcharges for stainless steel static oven

+ € 63

COMPOSIZIONE ALTA L 300 (con gola L 305)

HIGH COMPOSITION W 300 (with finger rail W 305)



COMPOSIZIONE BASSA L 360 (con gola L 365)

LOW COMPOSITION W 360 (with finger rail W 365)



COMPOSIZIONE ALTA L 300 (con gola L 305)

HIGH COMPOSITION W 300 (with finger rail W 305)

(IVA e contributo RAEE esclusi)

(VAT and WEEE fee excluded)

COMPONENTI COMPONENTS

Colonna 60 frigo-freezer 230 classe A+

60 cm column fridge-freezer 230 class "A+"

Base 60 2 cassetti e cestone

60 cm base unit with 2 drawers and deep drawer

Base 60 forno statico nero con ventilazione tangenziale di raffreddamento

static oven with orbital cooling ventilation 60 base unit

Piano cottura 60 4 gas inox con valvola di sicurezza

60 cm stainless steel hob with 4 gas burners with safety valve

Base 60

60 cm base unit

Sottolavello 60

60 cm sink unit

Lavello ad incasso 86 x 50 1 vasca inox prelucidato

86x50 cm built-in sink with 1 stainless steel bowl

Pensile 60 H 72

60 cm wall unit H 72

Cappa 60 aspirante estraibile H 63 2 motori

60 cm hood slide-out ducting H 63 2 motors

Pensile 60 H 96

60 cm wall unit H 96

Scolapiatti 60 H 96

60 cm plate rack H 96

Top 240 P 61 in laminato H 4

240 cm laminate worktop D 61 H 4

Mensola 120 P 31 sp. 3,8

120 cm shelf D 31 sp. 3,8

Asta appendipensili ml 4

4 lm wall unit fixing strip

(Elettrodomestici Indesit)
(Indesit appliances)

versioni REΣIND BRIDGE versions

MELAMINICO

€ 4.222

LACCATO

€ 4.303

versioni REΣIND NECK versions

MELAMINICO

€ 4.806

LACCATO

€ 5.038

Maggiorazione per forno statico inox
surcharges for stainless steel static oven

+ € 63

COMPOSIZIONE BASSA L 360 (con gola L 365)

LOW COMPOSITION W 360 (with finger rail W 365)

(IVA e contributo RAEE esclusi)

(VAT and WEEE fee excluded)

COMPONENTI COMPONENTS

Colonna 60 frigo-freezer 230 classe A+

60 cm column fridge-freezer 230 class "A+"

Colonna 60 con cestone, forno statico nero con ventilazione tangenziale di raffreddamento

60 column with deep drawer configured for static oven with orbital cooling ventilation

Base 90 2 cassetti + cestone predisposto P.C.

90 cm base unit with 2 drawers + deep drawer configured for hob

Piano cottura 60 4 gas inox con valvola di sicurezza

60 cm stainless steel hob with 4 gas burners with safety valve

Base 60

60 cm base unit

Sottolavello 90

90 cm sink unit

Lavello ad incasso 86 x 50 1 vasca inox prelucidato

86x50 cm built-in sink with 1 stainless steel bowl

Pensile 60 H 72

60 cm wall unit H 72

Cappa 90 sempione acciaio inox satinato + vetro

90 cm sempione hood brushed stainless steel + glass

Pensile 60 H 72

60 cm wall unit H 72

Scolapiatti 90 H 72

90 cm plate rack H 72

Top 240 P 61 in laminato H 4

240 cm laminate worktop D 61 H 4

Top 60 P 61 in laminato H 4

60 cm laminate worktop D 61 H 4

Asta appendipensili ml 4

4 lm wall unit fixing strip

(Elettrodomestici Indesit)
(Indesit appliances)

versioni REΣIND BRIDGE versions

MELAMINICO

€ 4.373

LACCATO

€ 4.412

versioni REΣIND NECK versions

MELAMINICO

€ 4.895

LACCATO

€ 5.007

Maggiorazione per forno statico inox
surcharges for stainless steel static oven

+ € 63

