

**MAGGIORAZIONE
SURCHARGE**

+6% +8%

**DAL 23 GENNAIO 2023
FROM JANUARY 23, 2023**

KYRA moderno

CONDIZIONI GENERALI DI VENDITA

DECORRENZA

Il presente listino sostituisce ed annulla tutti i precedenti.

Non costituisce offerta e può essere modificato, con comunicazione scritta dell'AZIENDA al Cliente, in qualsiasi momento anche senza preavviso.

Le modificazioni o gli aggiornamenti avranno efficacia rispetto a tutti gli ordinativi pervenuti o trasmessi all'AZIENDA dopo la comunicazione scritta di cui sopra.

PREZZI DI LISTINO E CONDIZIONI DI PAGAMENTO

I prezzi sono quotati al pubblico I.V.A. e contributo RAEE esclusi e si intendono franco fabbrica.

Decorso il termine contrattuale di pagamento l'AZIENDA è autorizzata alla emissione di tratte a saldo di ogni suo avere maggiorate degli interessi, spese e di ogni altro onere accessorio, previa comunicazione al Cliente. In caso di pagamento oltre i termini contrattuali, saranno addebitati gli interessi ai sensi del D.lgs. 231/2002, oltre al recupero di eventuali sconti espressamente concessi in ragione del termine di pagamento.

In caso di mancato pagamento nei tempi contrattuali l'AZIENDA potrà sospendere l'evasione degli ordini in corso previa comunicazione al Cliente.

CONSEGNA

I termini di consegna vengono computati in giorni lavorativi con decorrenza dal perfezionamento del contratto di vendita, che comunque si intende perfezionato entro 8 giorni dall'invio dell'ordine o comunque entro 8 giorni dall'ultimo chiarimento (se richiesto) fornito dal Cliente. I termini di consegna saranno prorogati automaticamente in dipendenza di avvenimenti non imputabili all'AZIENDA o a cause di forza maggiore. Sono sempre ammesse consegne parziali.

PRODOTTO

I dati tecnici relativi ai prodotti illustrati nel presente listino sono puramente indicativi come indicativi. L'AZIENDA si riserva la facoltà di apportare tutte le modifiche tecnico-costruttive migliorative del prodotto, senza obbligo di preavviso. La merce potrà tuttavia presentare caratteristiche parzialmente difformi da quelle indicate nel listino e nel catalogo, e comunque non risultare del tutto identica ai campioni che eventualmente fossero stati visionati in occasione della effettuazione dell'ordine, dovendosi riconoscere margini di tolleranza per quanto concerne i colori e le tonalità. La conformità al campione non deve intendersi in senso tassativo. Ciò vale anche per gli elettrodomestici o altri accessori impiegati a corredo delle cucine; questi potranno risultare esteticamente leggermente difformi in base alle marche utilizzate diverse da quelle da catalogo, salvo la sostanziale conformità delle caratteristiche e delle funzioni. Il Cliente potrà richiedere elementi specifici indicandone la marca sempre nell'ambito del ventaglio di offerte dell'AZIENDA non assume alcuna responsabilità circa la tenuta dei supporti che dipendesse da insufficienza della parete a cui venissero applicati gli stessi poiché la verifica dell'idoneità della parete dovrà essere effettuata dal cliente.

CONSISTENZA FINITURE

Le finiture potrebbero subire nel tempo modificazioni di colore dovute all'esposizione alla luce, al calore, ai vapori e all'invecchiamento. È, pertanto, naturale che in caso di successivi completamenti, si potranno avere delle differenze di tonalità che comunque dovrebbero tendere ad attenuarsi nel tempo. Per i piani in marmo e granito, considerando che il taglio proviene da BLOCCHI NATURALI, non possiamo garantire l'uniformità del colore e della grana. Questi fattori non potranno costituire motivo di contestazione o di resa del prodotto.

TRASPORTO

La merce non viaggia mai con mezzi dell'AZIENDA e, di conseguenza, nel momento in cui questa viene affidata al vettore, a prescindere da chi lo abbia incaricato, o caricata nel mezzo del cliente tutti i rischi passano al cliente stesso. Il Cliente, anche tramite suoi incaricati, ha l'obbligo di controllare l'integrità della merce all'arrivo ed, eventualmente, fare le dovute contestazioni scritte al Vettore. Qualora il danno rende inutilizzabile la merce è opportuno non ritirarla dandone conto nel Documento di Trasporto, diversamente con l'apposizione della firma da parte del Cliente, senza alcuna contestazione e/o rilievo si attesta la perfetta integrità e conformità della merce.

INSTALLAZIONE E IMPIEGO

L'AZIENDA declina ogni responsabilità per l'errata o impropria installazione del prodotto fornito (mobili, piani di lavoro, elettrodomestici, impianti elettrici o idraulici ecc.) siano essi di sua fabbricazione o di terzi, sempre che non provveda essa stessa alle predette operazioni. L'acquirente non potrà in nessun caso richiedere il risarcimento dei danni eventualmente causati in occasione dell'installazione. L'AZIENDA si ritiene esonerata da qualsiasi responsabilità circa il funzionamento degli elettrodomestici e degli accessori fabbricati da terzi costruttori, per i quali venga fornito dal predetto fabbricante lo specifico libretto di uso e manutenzione; nel libretto si troverà indicato l'eventuale Ufficio Reclami o i Centri di Assistenza del terzo fabbricante. Per l'impropria e/o inadeguata manutenzione, nonché per l'improprio e/o inadeguato utilizzo dei prodotti venduti, l'AZIENDA rinvia ogni e qualsiasi responsabilità e/o onere al Cliente o all'Utilizzatore.

RECLAMI ED AZIONI

I vizi e i difetti devono essere denunciati all'AZIENDA nei termini di legge. Anche nel caso di contestazione i pagamenti non potranno essere sospesi.

La merce rimarrà di proprietà dell'AZIENDA sino al pagamento totale da parte del committente.

GARANZIA

La garanzia sui prodotti venduti opererà per il tempo che, di volta in volta, le leggi vigenti nel Paese del Cliente stabiliranno come minimo a favore dell'acquirente.

RESTITUZIONE DI MERCE

La restituzione delle merci vendute si accetta solo se espressamente autorizzata dall'AZIENDA. Verranno concordate modalità di reintegro e di accredito, solo qualora la restituzione sia dovuta a fatti imputabili all'AZIENDA. La merce restituita dovrà essere consegnata in perfette condizioni e adeguatamente imballata. Eventuali alterazioni nella tonalità dei colori che si verificassero per fattori ambientali o comunque per cause non imputabili all'AZIENDA non consentiranno di procedere alla resa della merce.

SPESE

Per i pagamenti a mezzo tratte o ricevute bancarie verranno addebitati tutti gli oneri accessori alla riscossione.

CONTROVERSIE

Per ogni controversia il Foro competente sarà esclusivamente quello di Macerata.

EFFICACIA

Il Cliente, con il solo fatto di conferire l'ordinativo, si dichiara edotto ed accetta tutte le condizioni di vendita che precedono, salvo espresso patto contrario.

MARCHIO

Il marchio  è un marchio commerciale registrato, la proprietà dei diritti di utilizzazione economica appartengono esclusivamente a l'AZIENDA o a terzi, pertanto è espressamente vietato l'utilizzo senza il preventivo consenso scritto del proprietario. L'utilizzo del marchio da parte dei clienti ai fini pubblicitari dovrà comunque essere preventivamente autorizzato dall'AZIENDA previa presa visione del materiale prima della pubblicazione. In ogni caso il logo non potrà subire alcuna modifica od alterazione nelle forme e nei colori ne potrà essere associato a prezzi o sconti promozionali.

GENERAL SALES CONDITIONS

VALIDITY

This price list replaces and annuls all previous versions.

It does not constitute an offer and may be subject to change following a written notification by COMPANY to the Customer, at any time and without prior notice. Any modifications or updates shall apply to all orders received by or transmitted to COMPANY following the above-mentioned written notification.

RETAIL PRICES AND PAYMENT TERMS

The retail prices quoted are exclusive of VAT and the WEEE fee and are ex works.

Upon expiry of the agreed payment term, COMPANY shall be authorised to issue bills of exchange for any outstanding amounts on every item, plus interest, expenses and any other additional liability, prior notification to the Customer. In the event of payment after the agreed term, accrued interest shall be charged in compliance with Italian Legislative Decree no. 231/2002, while any discounts expressly granted in relation to the payment terms shall be recovered.

If payment is not received within the agreed terms, COMPANY shall be entitled to suspend fulfilment of current orders, prior notification to the Customer.

DELIVERY

The delivery term is calculated in working days and takes effect from the date on which the sales contract is stipulated. In any case, the contract is considered effective within 8 days from order transmission or, at all events, within 8 days from the most recent clarification (if requested) provided by the Customer. The delivery term shall be automatically extended should any events occur that are not imputable to COMPANY or that are due to force majeure. Partial deliveries can always be effected.

THE PRODUCT

Any technical data relating to the products illustrated in this price list is purely indicative. The COMPANY reserves the right to effect any technical or structural modifications to improve the product, without prior notice. The goods may differ to some extent from the specifications given in the price list and the catalogue, or not be identical in all aspects to the samples viewed at the time of the order, since tolerances in relation to colours and tonalities are inevitable. Conformity with the samples is not obligatory. This right extends to household appliances or other kitchen furniture accessories; the appearance of the latter may differ slightly depending on the brand in question (which may differ from that shown in the catalogue), without prejudice to the basic conformity of features and functions. The Client may request specific components of a given brand from the range of products offered by the COMPANY, which is not liable in any way for the load bearing capacity of supports depending on the characteristics of the walls to which they are mounted; the Client alone is responsible for ensuring that the walls are able to support the load.

CONSISTENCY OF THE FINISHES

The finishes may be subject to slight changes in colour over time as a result of exposure to light, heat, vapours and ageing. Therefore, in the event of completion orders, there may be shade differences that will tend to diminish over time. Regarding marble and granite worktops, we cannot guarantee uniformity of colour and vein pattern as the worktops are cut from NATURAL BLOCKS. These factors may not provide grounds for claims or return of products.

TRANSPORT

The goods never travel on vehicles owned by COMPANY; therefore, from the moment the goods are handed over to the forwarder and regardless of who entrusted the latter with the transport or loaded the goods into the customer's vehicle, all risks are transferred to the customer. The Customer - also through persons delegated by the latter - is obliged to check the integrity of the goods upon their arrival, and to notify written claims to the Forwarder. The Customer should not accept any damaged goods that are unsuitable for their intended use, and should notify the relevant claim on the transport document; otherwise, by signing the transport document without adding any claims and/or observations, the Customer certifies the integrity and conformity of the goods.

INSTALLATION AND USE

The COMPANY is not liable for incorrect or improper installation of the supplied product (units, tops, household appliances, electrical and plumbing systems, etc.), whether manufactured by the company or by third parties, unless the COMPANY itself does the installation. The purchaser may not claim for any damages caused during installation. Moreover, the COMPANY is not liable for the operation of household appliances and accessories manufactured by third parties, for which user and maintenance manuals are provided by the manufacturer in question; the manuals include information regarding the Claims Office or Technical Assistance Centres of the third party manufacturer. As regards improper and/or inadequate maintenance, or any improper and/or inadequate use of the products sold, the COMPANY transfers all liability and/or resulting costs to the Client or User.

CLAIMS

Any faults or defects must be reported to COMPANY within the terms specified by the law. Payment may not be suspended, even in the event of notification of claims. The goods shall remain the property of COMPANY unless fully paid by customer.

WARRANTY

Warranty on sold products in favour of the purchaser shall apply for the minimum duration specified case-by-case by the laws in force in the Customer's country.

RETURN OF GOODS

The Client may only return goods after purchase if the COMPANY expressly authorises him to do so. Replacements and reimbursements for returned goods will be agreed between the parties only if the return is due to events demonstrably imputable to the COMPANY. The returned goods must be delivered in perfect condition and suitably packaged. Alterations to the colours caused by environmental factors or by any cause not imputable to the COMPANY are not grounds for the return of purchased goods.

EXPENSES

For payments effected through bill of exchange or cash order, all additional collection expenses shall be charged.

DISPUTES

The Court of Macerata shall have sole jurisdiction for any disputes that may arise.

EFFECTIVENESS

For the sole fact of conferring the order, the Customer declares to be informed and accepts all the aforementioned sale conditions, unless otherwise expressly agreed on.

BRAND

The trademark  is registered; the right of the commercial exploitation belongs only to the COMPANY or a third party, and the trademark may not be used without the owner's written consent. The client may only use the trademark for reasons of publicity if authorised in advance by COMPANY, following review of the material before publication. In any case, the logo may not be modified or altered in form or colour, nor may it be associated with promotional prices or discounts.

INFORMAZIONI TECNICHE

TECHNICAL INFORMATION

Le misure indicate nel presente listino sono espresse in cm.

Le profondità delle basi si intendono comprensive di top.

Le profondità dei pensili e delle colonne si intendono comprensive di ante.

Le altezze delle basi e delle colonne si intendono comprensive di zoccolo

Il verso degli elementi è individuato dalla posizione delle cerniere. Fanno eccezione solo l'angolo base e la colonna ad angolo dove il verso viene individuato dalla posizione dell'anta rispetto al mobile.

Per gli elementi con il verso, è stato inserito il codice con entrambi i versi (ad esempio una base da cm 45 cod. E4010451/2).

Sarà quindi necessario specificare se l'ultima cifra dovrà essere "1" per il verso destro cioè E4010451 oppure "2" per il verso sinistro cioè E4010452.

Per i lavelli il verso dx o sx è individuato dalla posizione delle vasche.

I prezzi indicati sono espressi all'unità di euro e sono IVA e contributo RAEE esclusi

I prezzi delle basi e delle colonne sono comprensivi dello zoccolo standard.

Per tutti i mobili fuori misura ha valore il listino riportato nella pagina maggiorazioni fuori misura.

Nel caso vengano richieste maniglie con passo diverso da quello previsto dal modello, le ante verranno fornite senza fori maniglia.

I colori delle immagini riportate nel presente listino sono solamente indicativi e non possono essere utilizzati come riferimento.

The measurements appearing in this price list are expressed in cm.

The depths of base units are inclusive of the worktop.

The depths of the wall units and columns are inclusive of the doors.

The heights of the base units and columns are inclusive of the plinth.

The direction of the elements is determined by the position of the hinges. The only exceptions are the corner base unit and corner column, where the direction is determined by the position of the door in relation to the cabinet.

For elements that come with a direction, the code includes both directions (e.g. 45 cm base unit - code E4010451/2).

It is therefore necessary to specify the last figure - "1" for the RH direction, i.e. E4010451, or "2" for the LH direction, i.e. E4010452.

The RH or LH direction of the sinks is determined by the position of the bowls.

The prices indicated are expressed in units of Euro and exclude VAT and the WEEE fee.

Prices of the base units and columns are inclusive of the standard plinth.

The prices that apply to all custom-sized cabinets are indicated on the page "Surcharges for custom-sized elements".

In the event of handles requested with a different centre-to-centre distance compared to the standard for the model, the doors will be supplied without pre-drilled holes for the handles.

The colours in the pictures appearing in this price list are purely indicative and should not be used as reference.

COMPOSIZIONI SENZA ELETTRODOMESTICI

COMPOSITIONS WITHOUT HOUSEHOLD APPLIANCES

Tutte le composizioni richieste prive di elettrodomestici (frigo, forno, piano cottura, lavastoviglie o lavatrice), saranno aumentate di un importo netto pari a € 100 iva esclusa. Tale direttiva non si applica se la cucina contiene almeno due di questi elettrodomestici.

All compositions requested without household appliances (fridge, oven, cooker hob, dishwasher or washing machine) shall be subject to a price increase of € 100 VAT excluded. This measure does not apply if the kitchen contains at least two of the above-mentioned appliances.

ELEMENTI FUORI MISURA

CUSTOM-SIZED ELEMENTS

MODELLI MODELS	MODIFICABILE IN LARGHEZZA WIDTH ADJUSTABLE	MODIFICABILE IN ALTEZZA HEIGHT ADJUSTABLE
KYRA	SI YES	SI YES

L'AZIENDA si riserva di accettare o meno la realizzazione di fuori misura di notevole difficoltà tecnica, previo invio di un disegno e successiva autorizzazione del ns. ufficio tecnico. Il prezzo di tali fuori misura sarà stabilito di volta in volta. Si intende che gli elementi fuori misura realizzati su Vs. richiesta, non saranno oggetto di ritiro.

COMPANY reserves the right to accept or decline processing of custom-sized elements that imply significant technical difficulties, subject to transmission of the drawing and subsequent authorisation by our Technical Dept. The price of these custom-sized elements shall be defined case-by-case. Any custom-sized elements manufactured on your request shall not be collected in the event of claims.

MAGGIORAZIONI PER ELEMENTI FUORI MISURA

SURCHARGES FOR CUSTOM-SIZED ELEMENTS

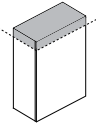
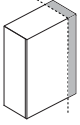
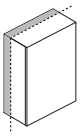
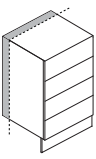
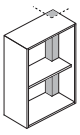
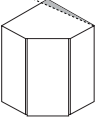
	DESCRIZIONE DESCRIPTION	MAGGIORAZIONE SURCHARGE		DESCRIZIONE DESCRIPTION	MAGGIORAZIONE SURCHARGE
	Riduzioni in altezza Height reduction			Basi angolo fuori squadra Out-of-plumb corner base units	
		Basi Base units + 25 %			
		Pensili Wall units + 25 %			
		Colonne Columns + 25 %			+ 28 %
	Riduzioni in larghezza Width reduction			Basi e sottolavelli con portabombola Base and sink base units with cylinder holder	
		Basi Base units + 28 %			
		Pensili Wall units + 28 %			
		Colonne Columns + 28 %			+ 20 €
	Riduzioni in profondità Depth reduction			Maggiorazioni per fianco scavato per inserimento piano cottura tra due basi (PPC opz. 011/012) Surcharge for digged side to insert cooking hob between two bases (PPC opt. 011/012)	
		Basi Base units + 18 %			
		Pensili Wall units + 18 %			
		Colonne Columns + 18 %			Cadauno each + 23 €
	Riduzioni per cassettera N.B.: modificabili solo in profondità fino a 31 cm al fianco Reductions for drawer unit Note: can only be modified depth-wise up to 31 cm on the side			Maggiorazioni per raggatura top e mensola in laminato Surcharges for rounded edge on laminate worktop and shelf	
					Codice code T9STP + 35 €
	Taglio per pilastro N.B.: non realizzabile nei pensili con meccanismi Indent for pilaster Note: not feasible on wall units with mechanisms			Maggiorazione per inserimento tubo cappa (da sommare al prezzo del pensile) Surcharge for insertion of the hood pipe (to be added to the price of the wall unit)	
		Basi Base units Cod. T9SCB + 90 €			
		Pensili Wall units Cod. T9SCB + 90 €			
		Colonne Columns Cod. T9SCC + 130 €			+ 90 €
	Pensili angolo fuori squadra Out-of-plumb corner wall units			Maggiorazione per inserimento cappa non standard N.B.: verificare sempre la fattibilità dell'incasso con il nostro ufficio tecnico Surcharge for the insertion of a non-standard hood Note: always verify the feasibility of the installation	
					+ 90 €

La maggiorazione è da applicare al prezzo dell'elemento di serie più grande rispetto a quello delle dimensioni richieste.

Negli elementi fuori misura per motivi di lavorazione, l'estetica può risultare inferiore agli elementi di serie.

The surcharge applies to the price of the standard element that is next largest to that of the requested size.

Due to the processing involved, the aesthetic level of custom-sized elements may be slightly inferior to that of standard elements.

kyra

Tante le novità per il SISTEMA CUCINA KYRA, che permettono di realizzare con la massima libertà compositiva ambienti cucina e zone living personalizzate come un abito sartoriale. Con Kyra si può avere l'anta caratterizzata da una delle maniglie della nuova collezione, studiata appositamente con finiture dal carattere vintage o moderno.

Di particolare interesse estetico e funzionale è KYRA VINTAGE che, grazie a materiali e accessori dalle finiture e dal design esclusivo, propone un inedito mood che ricorda la aree dei Docks o dei grandi loft ricavati da luoghi del passato industriale. Molte le possibilità di scelta di finiture e colori per abbinamenti moderni e ricercati: tutte le ante sono lisce e dello spessore di 20 mm e si possono avere nelle nuove finiture TSS (Tecno Structure Surface) Sincro Poro fiamma verticale, nell'esclusivo Sincro Poro effetto Vintage a fiamma verticale, nell'aristocratico effetto vetro lucido e opaco, nel pratico MDF rivestito in Polimerico nei colori tinta unita lucidi o opachi e nei colori legno lucidi e opachi e nel prestigioso MDF Laccato fronte e bordi lucido e opaco che, oltre ai nuovi colori Fango, Bianco Caldo e all'esclusivo Peltro, viene proposto a campione nei colori della vasta gamma RAL. Originale l'anta a telaio in MDF laccata Peltro con vetro retinato per caratterizzare ancor più le composizioni di Kyra Vintage. Ad arricchire le potenzialità del programma viene proposto KYRA STORAGE, una serie di moduli a scaffale di nuova concezione per una maggiore libertà di configurazione per ambienti emozionali e funzionali. I mille dettagli e le molteplici possibilità compositive fanno di Kyra un modello tipico della produzione Creo Kitchens.





CREO ECOLOGIC

IL GRUPPO LUBE HA SCELTO DI UTILIZZARE PER I COMPONENTI COSTITUENTI LE STRUTTURE DELLE CUCINE SOLO MATERIALE A BASSISSIMA EMISSIONE DI FORMALDEIDE: CONFORMI ALLO STANDARD F4STELLE SECONDO LA NORMA JIS, CERTIFICATO DAL MINISTERO GIAPPONESE, IL PIU' SEVERO IN MERITO ALLE NORMATIVE DI SALVAGUARDIA AMBIENTALE.

Regarding the production of its kitchen structure components, lube group has decided to only use materials featuring very low formaldehyde emissions complying with the 4-star standard, as defined by the jis regulation. This standard is certified by the japanese government-the most rigorous when it comes to environmental protection.

In the KYRA KITCHEN SYSTEM there are a lot of news which allow to realize kitchens and living areas with the maximum of creativity for the composition, as for a custom tailored suit. The Kyra door can be characterized by one of the new collection handles, specifically designed with the finishes in vintage or modern style. KYRA VINTAGE is very interesting both from the aesthetic and functional point of views, thanks to the unique finishes and design of materials and accessories. It offers a new reminiscent mood characterizing the Docks areas, or the big lofts built in the industrial sites of the past. There are many choices of finishes and colors for modern and sophisticated combinations: all doors are smooth with 20 mm of thickness, and available in the new TSS finishes (Surface Structure Technology) as in the vertical flame Synchro Pore, then in the exclusive Synchro Pore vintage effect with vertical flame, in the refined gloss and matt glass effect, in the practical MDF covered with Polymeric glossy and matt solid colors or glossy and matt wood colors, and finally in the prestigious lacquered MDF (glossy and matt front and edges), that in addition to the new colors Mud, Warm White and to the exclusive Pewter, is proposed to sample in the RAL wide range of colors. Very original is the lacquered Pewter MDF frame door, with wired glass to characterize even more the Kyra Vintage compositions. To enrich the potential of the program the brand proposes KYRA STORAGE, a range of open modules created to offer a greater possibility of configuration for emotional and functional environments. Thanks to the many details and configuration solutions, Kyra can be defined as a typical model of Creo Kitchens production.

CREOKITCHENS

CARATTERISTICHE TECNICHE

ANTE E FRONTALI CASSETTI

pannello TSS (thermo-structured-surface) sp.20 mm con fiamma verticale sincro poro nei colori opachi: rovere bianco spazzolato (opz.5311), rovere cipria spazzolato (opz.5312)

in melaminico sp.20 mm con fiamma verticale sincro poro effetto vintage nei colori opachi: abete nordico bianco (opz.4406), abete nordico terra (opz.4407), rovere naturale vintage (opz.5310)

ANTE VETRO

di serie: telaio in alluminio finitura brill sp.20 mm, con maniglia incorporata L 160 mm, vetro satinato sp.4 mm

a richiesta: telaio in mdf laccato peltro sp mm 20, vetro retinato sp.6 mm

MANIGLIE

di serie: **K50 finitura cromo passo mm 160/320 in funzione dell'anta**

a richiesta: **K54 finitura cromo passo mm 64/160/320* in funzione dell'anta (*maggiorazione € 5 cad.)**

F466 finitura cromo passo mm 160

F499 finitura cromo passo mm 160

F497 finitura cromo passo mm 160

477 finitura cromo passo mm 64/160/320* in funzione dell'anta (*maggiorazione € 7 cad.)

F482 finitura cromo passo mm 160

F463 finitura cromo passo mm 160

K01 finitura cromo passo mm 160

K52 finitura cromo passo mm 64/160/320 in funzione dell'anta

K82 finitura nichel satinato passo mm 128

K10 finitura nichel satinato passo mm 128/320 in funzione dell'anta

412 pomo finitura nichel satinato passo mm 16

K02 finitura bronzo titanio passo mm 160

581 incassata finitura bronzo titanio passo mm 128 (maggiorazione € 8 cad.)

790C finitura brill montata in orizzontale passo in funzione dell'anta (vedi maggiorazioni pag.35)

790M finitura brown montata in orizzontale passo in funzione dell'anta (vedi maggiorazioni pag.35)

STRUTTURE

ANTA: ROVERE BIANCO SPAZZOLATO

nobilitato bianco (opz.001), schiena e ripiano bianco (opz.001)

ANTE: ROVERE CIPRIA SPAZZOLATO, ABETE NORDICO TERRA

nobilitato perla d'oriente (opz.940), schiena e ripiano avorio (opz.930)

ANTE: ABETE NORDICO BIANCO, ROVERE NATURALE VINTAGE

nobilitato visone (opz.948M) schiena e ripiano bianco (opz.001)



MENSOLE

di serie: altezza 3,8 cm in laminato bianco (opz.001), perla d'oriente (opz.940), visone (opz.948M)

a richiesta: altezza 3,8 cm in melaminico rovere bianco spazzolato (opz.5311), rovere cipria spazzolato (opz.5312), abete nordico bianco (opz.4406), abete nordico terra (opz.4407), rovere naturale vintage (opz.5310)

ZOCCOLI

di serie: altezza 15 cm in pvc ricoperti in melamina finitura acciaio (opz.407)

a richiesta: altezza 15 cm in pvc ricoperti in melamina colore alluminio satinato (opz.405)

altezza 15 cm in pvc ricoperti in melamina bianco (opz.001)

altezza 15 cm in alluminio finitura brill (opz.412), bianco semilucido (opz.A001), **vedi maggiorazioni pag.36**

altezza 15 cm in pvc laccato peltro (opz.L9549), **vedi maggiorazioni pag.36**

TECHNICAL SPECIFICATIONS

DOORS AND DRAWERS FRONTS	<p>TSS (thermo-structured surface) panel, Th. 20 mm, with vertical grain sync pore in the following matt colours: brushed white oak (opt.5311), brushed powder oak (opt.5312)</p> <p>melamine-faced panel, Th. 20 mm, with vertical grain sync pore vintage effect in the following matt colours: white nordic fir (opt.4406), earth nordic fir (opt.4407), vintage natural oak (opt.5310)</p>
GLASS DOORS	<p>standard: Th. 20 mm aluminium frame, brill finish, with incorporated W 160 mm handle. Satin glass th. 4 mm</p> <p>on request: pewter lacquered MDF frame Th. 20 mm, with 6 mm thick wired glass</p>
HANDLES	<p>standard: K50 chrome finish, 160/320 mm centre-to-centre distance depending on the door</p> <p>on request: K54 chrome finish, 64/160/320* mm centre-to-centre distance depending on the door (*surcharge € 5 each) F466 chrome finish, 160 mm centre-to-centre distance F499 chrome finish, 160 mm centre-to-centre distance F497 chrome finish, 160 mm centre-to-centre distance 477 chrome finish, 64/160/320* mm centre-to-centre distance depending on the door (*surcharge € 7 each) F482 chrome finish with 160 mm centre-to-centre distance F463 chrome finish, 160 mm centre-to-centre distance K01 chrome finish, 160mm centre-to-centre distance K52 chrome finish, 64/160/320 mm centre-to-centre distance depending on the door K82 satin nickel finish, 128 mm centre-to-centre distance K10 satin nickel finish centre-to-centre distance 128/320 mm depending on the door 412 knob with satin nickel finish, centre-to-centre distance 16 mm K02 titanium bronze finish, 160 mm centre-to-centre distance 581 built-in bronze titanium finish, 128 mm centre-to-centre distance (surcharge € 8 each) 790C brill finish, horizontally mounted, centre-to-centre distance depending on the door (see surcharges on page 35) 790M brown finish, horizontally mounted, centre-to-centre distance depending on the door (see surcharges on page 35)</p>
CARCASSES	<p>DOOR: BRUSHED WHITE OAK melamine-coated white (opt.001), white back panel and shelf (opt.001)</p> <p>DOORS: BRUSHED POWDER OAK, EARTH NORDIC FIR melamine-faced oriental pearl (opt.940), ivory (opt.930) back panel and shelf</p> <p>DOORS: WHITE NORDIC FIR, VINTAGE NATURAL OAK melamine-faced mink (opt.948M), white (opt.001) back panel and shelf</p>
SHELVES	<p>standard: height 3.8 cm, laminate in the colours white (opt.001), oriental pearl (opt.940), mink (opt.948M)</p> <p>on request: height 3.8 cm melamine-faced, brushed white oak (opt.5311), brushed powder oak (opt.5312), white nordic fir (opt.4406), earth nordic fir (opt.4407), vintage natural oak (opt.5310)</p>
PLINTHS	<p>standard: height 15 cm, melamine-faced pvc with steel finish (opt.407)</p> <p>on request: height 15 cm, melamine-faced pvc with satin aluminium finish (opt.405) height 15 cm, white melamine-faced pvc (opt.001) height 15 cm, aluminium with brill finish (opt.412), semi-glossy white (opt.A001), see surcharges on page 36 height 15 cm, pewter lacquered pvc (opt.L9549), see surcharges on page 36</p>



kyra melaminico melamine

cod. **K26**

ante opache TSS finitura sincro poro
TSS matt doors with sync pore finish

anta vetro telaio alluminio brill
glass door with brill aluminium frame

 *colori in pronta consegna*
available colours



rovere bianco spazzolato
(opz.5311)
brushed white oak
(opt.5311)



rovere cipria spazzolato
(opz.5312)
brushed powder oak
(opt.5312)

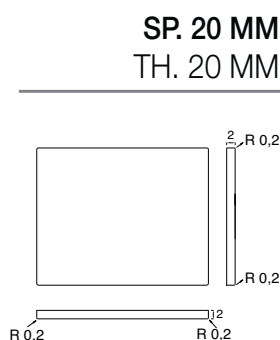

anta telaio alluminio brill,
con maniglia incorporata L 160 mm
vetro satinato (opz.419S)
door with aluminium frame brill finish
with incorporated handle W 160 mm,
satin glass (opt.419S)

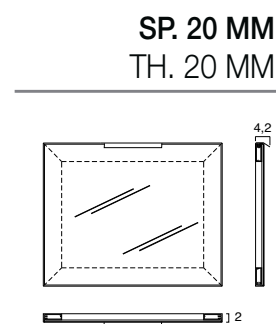

ante opache finitura sincro poro effetto vintage
matt doors with sync pore finish vintage effect

anta vetro effetto vintage **NEW**
vintage effect glass door



abete nordico bianco
(opz.4406)
white nordic fir (opt.4406)



abete nordico terra
(opz.4407)
earth nordic fir (opt.4407)



rovere naturale vintage
(opz.5310)
vintage natural oak (opt.5310)



telaio in mdf laccato peltro,
vetro retinato (opz.9549)
mdf frame with pewter finish,
wired glass (opt.9549)

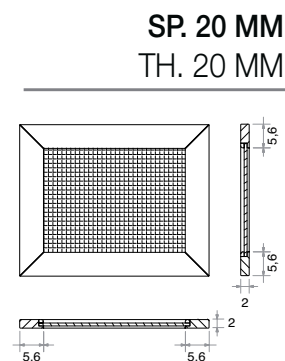

CARATTERISTICHE TECNICHE

ANTE E FRONTALI CASSETTI	<p>in MDF rivestito in polimerico tinta unita finitura opaca sp mm 20 con interno melaminico bianco opaco, nei colori: bianco assoluto (opz.740P), tortora scuro (opz.8981), kaschmir (opz.7713), grigio seta (opz.9605), grafite (opz.9619), blu petrolio (opz.8325), verde lichene (opz.8441), grigio polvere (opz.9617), melanzana (opz.270P)</p> <p>in MDF rivestito in polimerico effetto legno finitura opaca venatura orizzontale sp mm 20 con interno melaminico bianco opaco nei colori: olmo cotto (opz.5072), larice bianco sfumato grigio (opz.295P), noce chiaro (opz.238P), noce grigio (opz.239P), tranchè rovere champagne (opz.5273), tranchè rovere visone (opz.5275), rovere cenere (opz.260P), rovere naturale (opz.5344), frassino white (opz.2411), frassino dakar (opz.2412), frassino stone grey (opz.2413)</p> <p>in MDF rivestito in polimerico tinta unita finitura lucida sp mm 20 con interno melaminico bianco opaco, nei colori: bianco assoluto (opz.741P), tortora scuro (opz.8982), beige (opz.7712), grigio vapore (opz.9608), antracite (opz.9602), senape (opz.8224), celeste alpaca (opz.8322), grigio ghiaia (opz.9612), melanzana (opz.271P)</p> <p>in MDF rivestito in polimerico effetto legno finitura lucida venatura orizzontale sp mm 20 con interno melaminico bianco opaco, nei colori: larice grigio (opz.297P), larice bianco (opz.298P)</p>
ANTE VETRO	<p>di serie: telaio in MDF rivestito in polimerico finitura come anta sp mm 20, vetro satinato sp.4 mm</p> <p>a richiesta: telaio in alluminio finitura brill sp.20 mm, con maniglia incorporata L 160 mm, vetro satinato sp.4 mm</p>
MANIGLIE	<p>di serie: K50 finitura cromo passo mm 160/320 in funzione dell'anta</p> <p>a richiesta: K54 finitura cromo passo mm 64/160/320* in funzione dell'anta (*maggiorazione € 5 cad.) F466 finitura cromo passo mm 160 F499 finitura cromo passo mm 160 F497 finitura cromo passo mm 160 477 finitura cromo passo mm 64/160/320* in funzione dell'anta (*maggiorazione € 7 cad.) F482 finitura cromo passo mm 160 F463 finitura cromo passo mm 160 K01 finitura cromo passo mm 160 K52 finitura cromo passo mm 64/160/320 in funzione dell'anta K82 finitura nichel satinato passo mm 128 K10 finitura nichel satinato passo mm 128/320 in funzione dell'anta 412 pomo finitura nichel satinato passo mm 16 K02 finitura bronzo titanio passo mm 160 581 incassata finitura bronzo titanio passo mm 128 (maggiorazione € 8 cad.) 790C finitura brill montata in orizzontale passo in funzione dell'anta (vedi maggiorazioni pag.35) 790M finitura brown montata in orizzontale passo in funzione dell'anta (vedi maggiorazioni pag.35)</p>
STRUTTURE	<p>ANTE: BIANCO ASSOLUTO OPACO E LUCIDO, BLU PETROLIO OPACO, GRIGIO SETA OPACO, GRIGIO VAPORE LUCIDO, NOCE CHIARO, NOCE GRIGIO, LARICE BIANCO OPACO, GRIGIO POLVERE OPACO, CELESTE ALPACA LUCIDO, TRANCHÈ ROVERE CHAMPAGNE, FRASSINO WHITE, LARICE GRIGIO LUCIDO, LARICE BIANCO LUCIDO, MELANZANA OPACO E LUCIDO nobilitato bianco (opz.001), schiena e ripiano bianco (opz.001)</p> <p>ANTE: GRIGIO GHIAIA, TRANCHÈ ROVERE VISONE nobilitato devalè finitura grafis (opz.796), schiena e ripiano bianco (opz.001)</p> <p>ANTE: KASCHMIR OPACO, TORTORA SCURO OPACO E LUCIDO, SENAPE, BEIGE, FRASSINO DAKAR nobilitato perla d'oriente (opz.940), schiena e ripiano avorio (opz.930)</p> <p>ANTE: ROVERE CENERE, GRAFITE OPACO, ANTRACITE nobilitato rovere cenere (opz.261) schiena e ripiano bianco (opz.001)</p> <p>ANTA: OLMO COTTO nobilitato larice moro (opz.218) schiena e ripiano bianco (opz.001)</p> <p>ANTE: FRASSINO STONE GREY, ROVERE NATURALE, VERDE LICHENE OPACO nobilitato visone (opz.948M) schiena e ripiano bianco (opz.001)</p>



kyra polimerico

cod. **K27**

SP. 20 MM

N.B.: i prezzi sono espressi all'unità di euro (iva esclusa)

CARATTERISTICHE TECNICHE

MENSOLE

di serie: altezza 3,8 cm in laminato bianco (opz.001), perla d'oriente (opz.940), devalè finitura grafis (opz.796), rovere cenere (opz.261), larice moro (opz.218), visone (opz.948M)

a richiesta: altezza 3,8 cm in polimerico per le finiture vedi colore ante

ZOCCOLI

di serie: altezza 15 cm in pvc ricoperti in melamina finitura acciaio (opz.407)

a richiesta: altezza 15 cm in pvc ricoperti in melamina colore alluminio satinato (opz.405)

altezza 15 cm in pvc ricoperti in melamina bianco (opz.001)

altezza 15 cm in alluminio finitura brill (opz.412), bianco semilucido (opz.A001), [vedi maggiorazioni pag.36](#)

TECHNICAL SPECIFICATIONS

DOORS AND DRAWERS FRONTS

solid colour polymer-coated MDF with matt finish, Th. 20 mm, with matt white melamine-faced interior, in the following colours: absolute white (opt.740P), dark dove grey (opt.8981), kashmir (opt.7713), silk grey (opt.9605), graphite (opt.9619), petroleum blue (opt.8325), lichen green (opt.8441), dust grey (opt.9617), aubergine (opt.270P)

polymer-coated MDF with wood effect, matt finish, horizontal grain, Th. 20 mm with matt white melamine-faced interior, in the following colours: burnt elm (opt.5072), white larch grey fading (opt.295P), light walnut (opt.238P), grey walnut (opt.239P), rough-hewn champagne oak (opt.5273), rough-hewn mink oak (opt.5275), ash oak (opt.260P), natural oak (opt.5344), white ash (opt.2411), dakar ash (opt.2412), stone grey ash (opt.2413)

polymer-coated MDF with glossy solid colour finish, Th. 20 mm, with matt white melamine-faced interior, in the following colours: absolute white (opt.741P), dark dove grey (opt.8982), beige (opt.7712), steam grey (opt.9608), anthracite (opt.9602), mustard (opt.8224), alpaca light blue (opt.8322), gravel grey (opt.9612), aubergine (opt.271P)

polymer-coated MDF with wood effect glossy finish horizontal grain, Th. 20 mm with matt white melamine-faced interior, in the following colours: grey larch (opt.297P), white larch (opt.298P)

GLASS DOORS

standard: Th. 20 mm polymer-coated MDF frame with same finish as door. Satin glass th. 4 mm.

on request: Th. 20 mm aluminium frame, brill finish, with incorporated W 160 mm handle. Satin glass 4 mm.

HANDLES

standard: K50 chrome finish, 160/320 mm centre-to-centre distance depending on the door

on request: K54 chrome finish, 64/160/320* mm centre-to-centre distance depending on the door (*surcharge € 5 each)

F466 chrome finish, 160 mm centre-to-centre distance

F499 chrome finish, 160 mm centre-to-centre distance

F497 chrome finish, 160 mm centre-to-centre distance

477 chrome finish, 64/160/320* mm centre-to-centre distance depending on the door (*surcharge € 7 each)

F482 chrome finish with 160 mm centre-to-centre distance

F463 chrome finish, 160 mm centre-to-centre distance

K01 chrome finish, 160mm centre-to-centre distance

K52 chrome finish, 64/160/320 mm centre-to-centre distance depending on the door

K82 satin nickel finish, 128 mm centre-to-centre distance

K10 satin nickel finish centre-to-centre distance 128/320 mm depending on the door

412 knob with satin nickel finish, centre-to-centre distance 16 mm

K02 titanium bronze finish, 160 mm centre-to-centre distance

581 built-in bronze titanium finish, 128 mm centre-to-centre distance (surcharge € 8 each)

790C brill finish, horizontally mounted, centre-to-centre distance depending on the door (see surcharges on page 35)

790M brown finish, horizontally mounted, centre-to-centre distance depending on the door (see surcharges on page 35)

CARCASSES

DOORS: MATT AND GLOSSY ABSOLUTE WHITE, MATT PETROLEUM BLUE, MATT SILK GREY, GLOSSY STEAM GREY, LIGHT WALNUT, GREY WALNUT, MATT WHITE LARCH, MATT DUST GREY, GLOSSY ALPACA LIGHT BLUE, ROUGH-HEWN CHAMPAGNE OAK, WHITE ASH, GLOSSY GREY LARCH, GLOSSY WHITE LARCH, MATT AND GLOSSY AUBERGINE
melamine-coated white (opt.001), white back panel and shelf (opt.001)

DOORS: GRAVEL GREY, ROUGH-HEWN MINK OAK

melamine-faced devalè with grafis finish (opt.796), white (opt.001) back panel and shelf

DOORS: MATT KASHMIR, MATT AND GLOSSY DARK DOVE GREY, MUSTARD, BEIGE, DAKAR ASH

melamine-faced oriental pearl (opt.940), ivory (opt.930) back panel and shelf

DOORS: ASH OAK, MATT GRAPHITE, ANTHRACITE

melamine-faced ash oak (opt.261), white (opt.001) back panel and shelf

DOOR: BURNT ELM

melamine-faced dark brown larch (opt.218), white (opt.001) back panel and shelf

DOOR: STONE GREY ASH

melamine-faced mink (opt.948M), white (opt.001) back panel and shelf

kyra polymeric

cod. **K27**

SP. 20 MM

Note: the prices are expressed in units of euro (vat excluded)

TECHNICAL SPECIFICATIONS

SHELVES

standard: height 3.8 cm, laminate in the colours: white (opt.001), oriental pearl (opt.940), devalè with grafis finish (opt.796), ash oak (opt.261), dark brown larch (opt.218), mink (opt.948M)

on request: height 3.8 cm polymer-coated, for the finishes see door colour

PLINTHS

standard: height 15 cm, melamine-faced pvc with steel finish (opt.407)

on request: height 15 cm, melamine-faced pvc with satin aluminium finish (opt.405)

height 15 cm, white melamine-faced pvc (opt.001)

height 15 cm, aluminium with brill finish (opt.412), semi-glossy white (opt.A001), [see surcharges on page 36](#)

CREO[®]
KITCHENS

kyra polimerico opaco matt polymeric

cod. **K27**

ante doors

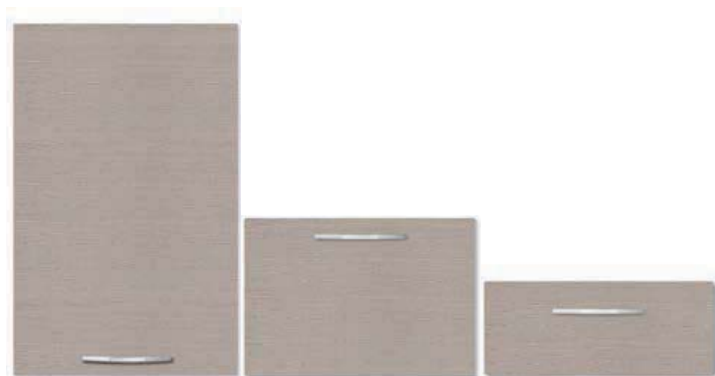

frassino dakar (opz.2412)
dakar ash (opt.2412)

cestone frassino dakar
(opz.2412)
dakar ash deep drawer
(opt.2412)

cassetto frassino dakar
(opz.2412)
dakar ash drawer (opt.2412)

SP. 20 MM TH. 20 MM

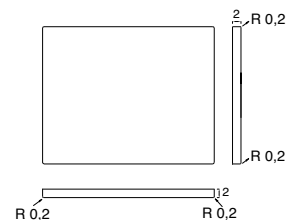

ante vetro di serie standard glass doors



telaio in polimerico
finitura frassino dakar
(opz.2412), vetro satinato
polymer-coated frame
with dakar ash finish
(opt.2412), satin glass

telaio cestone in polimerico
finitura frassino dakar
(opz.2412), vetro satinato
polymer-coated deep drawer
frame with dakar ash finish
(opt.2412), satin glass

a richiesta: ante vetro telaio alluminio brill standard: glass doors with brill aluminium frame

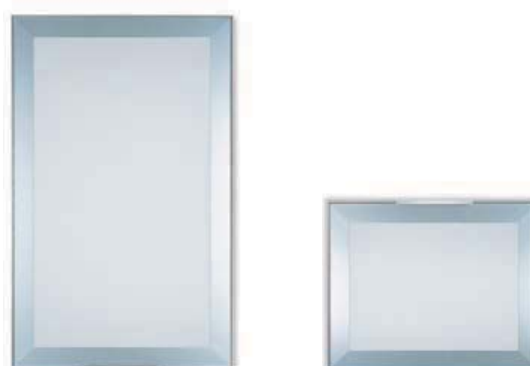

anta telaio alluminio brill,
con maniglia incorporata L 160 mm
vetro satinato (opz.419S)
door with aluminium frame brill finish
with incorporated handle W 160 mm,
satin glass (opt.419S)

cestone vetro telaio alluminio finitura brill,
con maniglia incorporata L 160 mm
vetro satinato (opz.419S)
door deep drawer with aluminium frame
with incorporated handle W 160 mm,
brill finish, satin glass (opt.419S)

SP. 20 MM TH. 20 MM

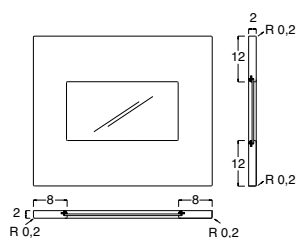

SP. 20 MM TH. 20 MM

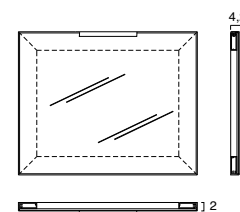

kyra polimerico opaco matt polymeric

cod. **K27**

colori tinta unita opachi matt solid colours

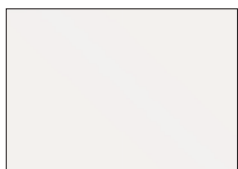

bianco assoluto (opz.740P)
absolute white (opt.740P)



tortora scuro (opz.8981)
dark dove grey (opt.8981)

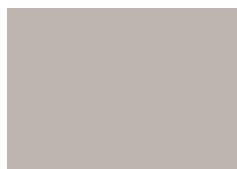

kaschmir (opz.7713)
kaschmir (opt.7713)



grigio seta (opz.9605)
silk grey (opt.9605)



melanzana (opz.270P)
aubergine (opt.270P)

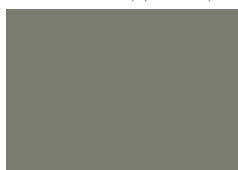

verde lichene (opz.8441)
lichen green (opt.8441)



grigio polvere (opz.9617)
dust grey (opt.9617)

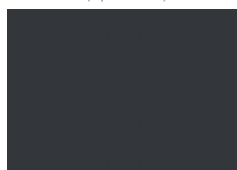

grafite (opz.9619)
graphite (opt.9619)

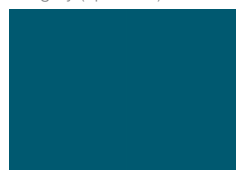

blu petrolio (opz.8325)
petroleum blue (opt.8325)

colori legno opachi matt wood colours



larice bianco (opz.295P)
white larch (opt.295P)



noce chiaro (opz.238P)
light walnut (opt.238P)



noce grigio (opz.239P)
grey walnut (opt.239P)



rovere cenere (opz.260P)
ash oak (opt.260P)

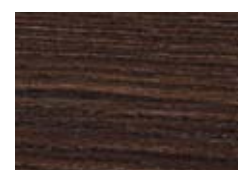

olmo cotto (opz.5072)
burnt elm (opt.5072)



tranchè rovere champagne (opz.5273)
tranchè champagne oak (opt.5273)



tranchè rovere visone (opz.5275)
tranchè mink oak (opt.5275)

NEW

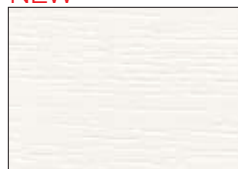

frassino white (opz.2411)
white ash (opt.2411)

NEW



frassino dakar (opz.2412)
dakar ash (opt.2412)

NEW



frassino stone grey (opz.2413)
stone grey ash (opt.2413)

NEW



rovere naturale (opz.5344)
natural oak (opt.5344)

colore interno delle ante internal door colour



bianco opaco
matt white

kyra polimerico lucido glossy polymeric

cod. **K27**

ante doors

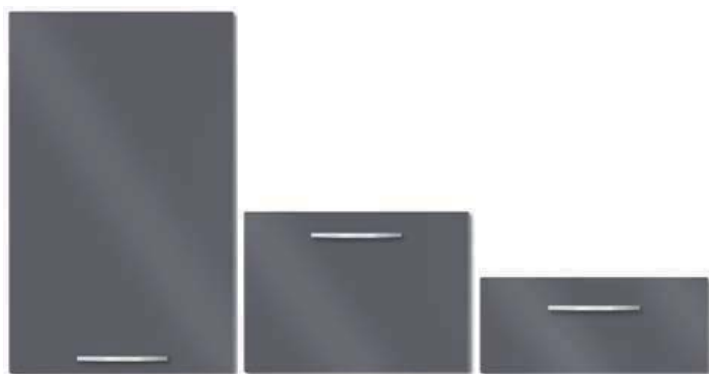

antracite (opz.9602)
anthracite (opt.9602)

cestone antracite
(opz.9602)
deep drawer
anthracite (opt.9602)

cassetto antracite
(opz.9602)
drawer
anthracite (opt.9602)

SP. 20 MM TH.20 MM

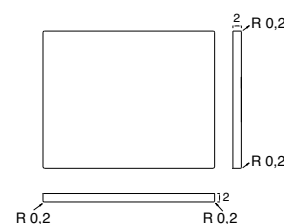

ante vetro di serie standard glass doors



telaio in polimerico
finitura antracite
(opz.9602), vetro satinato
polymeric frame with
anthracite finish
(opt.9602), satin glass

telaio cestone in polimerico
finitura antracite
(opz.9602), vetro satinato
deep drawer, polymeric frame
with anthracite finish
(opt.9602), satin glass

a richiesta: ante vetro telaio alluminio brill standard: glass doors with brill aluminium frame

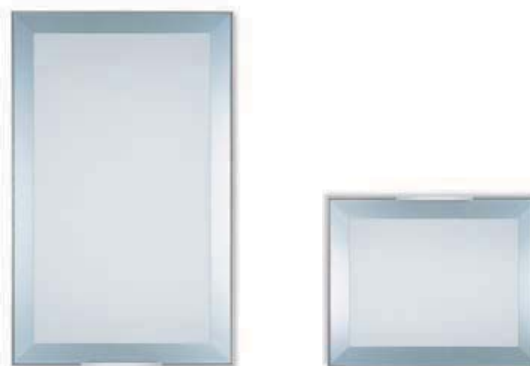

anta telaio alluminio brill,
con maniglia incorporata L 160 mm
vetro satinato (opz.419S)
door with aluminium frame brill finish
with incorporated handle W 160 mm,
satin glass (opt.419S)

cestone vetro telaio alluminio finitura brill,
con maniglia incorporata L 160 mm
vetro satinato (opz.419S)
door deep drawer with aluminium frame
with incorporated handle W 160 mm,
brill finish, satin glass (opt.419S)

SP. 20 MM TH. 20 MM

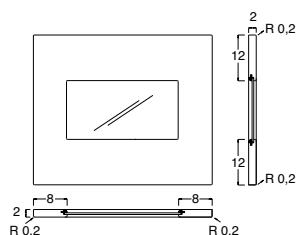

SP. 20 MM TH. 20 MM

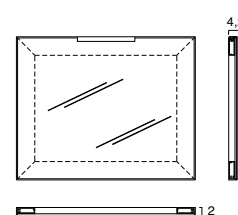

kyra polimerico lucido glossy polymeric

cod. **K27**

colori tinta unita lucidi glossy solid colours

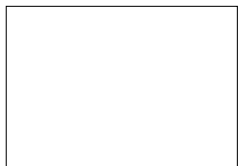

bianco assoluto (opz.741P)
absolute white (opt.741P)



tortora scuro (opz.8982)
dark dove grey (opt.8982)



beige (opz.7712)
beige (opt.7712)



grigio vapore (opz.9608)
steam grey (opt.9608)



antracite (opz.9602)
anthracite (opt.9602)



celesti alpaca (opz.8322)
alpaca light blue (opt.8322)



senape (opz.8224)
mustard (opt.8224)



grigio ghiaia (opz.9612)
gravel grey (opt.9612)



melanzana (opz.271P)
aubergine (opt.271P)

colori legno lucidi glossy wood colours



larice grigio (opz.297P)
grey larch (opt.297P)

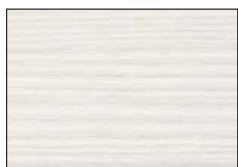

larice bianco (opz.298P)
white larch (opt.298P)

colore interno delle ante internal door colour



bianco opaco
matt white

CARATTERISTICHE TECNICHE

ANTE E FRONTALI CASSETTI

in MDF poliestereato 1 lato e bordi, retro in tinta laccato opaco, sp.20 mm finitura opaca soft nei colori: bianco caldo (opz.7401), tortora (opz.8991), visone (opz.946S), fango (opz.8905), bianco assoluto (opz.740S), cenere (opz.9547), avorio (opz.767S), cappuccino (opz.7771), lime (opz.8461), grigio argento (opz.9541), titanio (opz.9545), rosso (opz.125S), lavanda (opz.9141), lillà (opz.392S), glicine (opz.920S), rubino (opz.8151), prugna (opz.8631), blu aviazione (opz.8363), mandarino (opz.8155), lavagna (opz.9543), blu laguna (opz.8365), oro vecchio (opz.933S), blu oltremare (opz.922S), caffè (opz.887S), verde provenza (opz.8465), rosa quarzo (opz.8181), verde lichene (opz.8463), giallo ambra (opz.327S), grigio perla (opz.9555), nero assoluto (opz.786S)

in MDF poliestereato 1 lato e bordi, retro in tinta laccato opaco, sp.20 mm finitura lucida diretta nei colori: bianco caldo (opz.7402), tortora (opz.8992), visone (opz.947), fango (opz.8906), bianco assoluto (opz.741), cenere (opz.9548), avorio (opz.768), cappuccino (opz.7772), lime (opz.8462), grigio argento (opz.9542), titanio (opz.9546), rosso (opz.126), lavanda (opz.9142), lillà (opz.393), glicine (opz.921), rubino (opz.8152), prugna (opz.8632), blu aviazione (opz.8364), mandarino (opz.8156), lavagna (opz.9544), blu laguna (opz.8366), oro vecchio (opz.934), blu oltremare (opz.923), caffè (opz.888), verde provenza (opz.8466), rosa quarzo (opz.8182), verde lichene (opz.8464), giallo ambra (opz.328), grigio perla (opz.9556), nero assoluto (opz.787)

anta in MDF sp.20 mm laccata peltro 1 lato e bordi, retro opaco (opz.9549)

ANTE VETRO

di serie: telaio in alluminio finitura brill sp.20 mm, con maniglia incorporata L 160 mm, vetro satinato sp.4 mm

a richiesta: telaio in MDF laccato peltro sp mm 20, vetro retinato sp.6 mm

di serie per anta PELTRO: telaio in MDF laccato peltro sp mm 20, vetro retinato sp.6 mm

MANIGLIE

di serie: K50 finitura cromo passo mm 160/320 in funzione dell'anta

a richiesta: K54 finitura cromo passo mm 64/160/320* in funzione dell'anta (*maggiorazione € 5 cad.)

F466 finitura cromo passo mm 160

F499 finitura cromo passo mm 160

F497 finitura cromo passo mm 160

477 finitura cromo passo mm 64/160/320* in funzione dell'anta (*maggiorazione € 7 cad.)

F482 finitura cromo passo mm 160

F463 finitura cromo passo mm 160

K01 finitura cromo passo mm 160

K52 finitura cromo passo mm 64/160/320 in funzione dell'anta

K82 finitura nichel satinato passo mm 128

K10 finitura nichel satinato passo mm 128/320 in funzione dell'anta

412 pomo finitura nichel satinato passo mm 16

K02 finitura bronzo titanio passo mm 160

581 incassata finitura bronzo titanio passo mm 128 (maggiorazione € 8 cad.)

790C finitura brill montata in orizzontale passo in funzione dell'anta (vedi maggiorazioni pag.35)

790M finitura brown montata in orizzontale passo in funzione dell'anta (vedi maggiorazioni pag.35)

STRUTTURE

di serie: nobilitato perla d'oriente (opz.940), schiena e ripiano avorio (opz.930)

a richiesta: nobilitato bianco (opz.001), schiena e ripiano bianco (opz.001)

nobilitato visone (opz.948M) schiena e ripiano bianco (opz.001)

nobilitato devalè finitura grafis (opz.796), schiena e ripiano bianco (opz.001)

di serie per anta PELTRO: nobilitato visone (opz.948M) schiena e ripiano bianco (opz.001)



MENSOLE

di serie: altezza 3,8 cm in laminato bianco (opz.001), perla d'oriente (opz.940), visone (opz.948M), devalè finitura grafis (opz.796)

a richiesta: altezza 3,8 cm laccate per le finiture vedi colore ante

ZOCCOLI

di serie: altezza 15 cm in PVC ricoperti in melamina finitura acciaio (opz.407)

a richiesta: altezza 15 cm in PVC ricoperti in melamina colore alluminio satinato (opz.405)

altezza 15 cm in PVC ricoperti in melamina bianco (opz.001)

altezza 15 cm in alluminio finitura brill (opz.412), bianco semilucido (opz.A001), vedi maggiorazioni pag.36

altezza 15 cm in PVC laccato peltro (opz.L9549), vedi maggiorazioni pag.36

TECHNICAL SPECIFICATIONS

DOORS AND DRAWERS FRONTS

Polyester-coated MDF 1 side and edges, matt lacquered matching rear, Th. 20 mm, soft matt finish in the following colours: warm white (opt.7401), dove grey (opt.8991), mink (opt.946S), mud (opt.8905), absolute white (opt.740S), ash (opt.9547), ivory (opt.767S), cappuccino (opt.7771), lime (opt.8461), silver grey (opt.9541), titanium (opt.9545), red (opt.125S), lavender (opt.9141), lilac (opt.392S), wisteria (opt.920S), ruby (opt.8151), plum (opt.8631), aviation blue (opt.8363), mandarin (opt.8155), slate grey (opt.9543), lagoon blue (opt.8365), old gold (opt.933S), ultramarine blue (opt.922S), coffee (opt.887S), provence green (opt.8465), quartz pink (opt.8181), lichen green (opt.8463), amber yellow (opt.327S), pearl grey (opt.9555), absolute black (opt.786S)

Polyester-coated MDF 1 side and edges, matt lacquered matching rear, Th. 20 mm, direct glossy finish in the following colours: warm white (opt.7402), dove grey (opt.8992), mink (opt.947), mud (opt.8906), absolute white (opt.741), ash (opt.9548), ivory (opt.768), cappuccino (opt.7772), lime (opt.8462), silver grey (opt.9542), titanium (opt.9546), red (opt.126), lavender (opt.9142), lilac (opt.393), wisteria (opt.921), ruby (opt.8152), plum (opt.8632), aviation blue (opt.8364), mandarin (opt.8156), slate grey (opt.9544), lagoon blue (opt.8366), old gold (opt.934), ultramarine blue (opt.923), coffee (opt.888), provence green (opt.8466), quartz pink (opt.8182), lichen green (opt.8464), amber yellow (opt.328), pearl grey (opt.9556), absolute black (opt.787)

MDF panel, Th. 20 mm, pewter lacquered on 1 side and edges, matt rear (opt.9549)

GLASS DOORS

standard: Th. 20 mm aluminium frame, brill finish, with incorporated W 160 mm handle. Satin glass th. 4 mm.

on request: pewter matt lacquered MDF frame Th. 20 mm, with 6 mm thick wired glass

standard for PEWTER door: matt lacquered MDF frame Th. 20 mm, with 6 mm thick wired glass

HANDLES

standard: **K50 chrome finish, 160/320 mm centre-to-centre distance depending on the door**

on request: K54 chrome finish, 64/160/320* mm centre-to-centre distance depending on the door (***surcharge € 5 each**)
 F466 chrome finish, 160 mm centre-to-centre distance
 F499 chrome finish, 160 mm centre-to-centre distance
 F497 chrome finish, 160 mm centre-to-centre distance
 477 chrome finish, 64/160/320* mm centre-to-centre distance depending on the door (***surcharge € 7 each**)
 F482 chrome finish with 160 mm centre-to-centre distance
 F463 chrome finish, 160 mm centre-to-centre distance
 K01 chrome finish, 160mm centre-to-centre distance
 K52 chrome finish, 64/160/320 mm centre-to-centre distance depending on the door
 K82 satin nickel finish, 128 mm centre-to-centre distance
 K10 satin nickel finish centre-to-centre distance 128/320 mm depending on the door
 412 knob with satin nickel finish, centre-to-centre distance 16 mm
 K02 titanium bronze finish, 160 mm centre-to-centre distance
 581 built-in bronze titanium finish, 128 mm centre-to-centre distance (**surcharge € 8 each**)
 790C brill finish, horizontally mounted, centre-to-centre distance depending on the door (**see surcharges on page 35**)
 790M brown finish, horizontally mounted, centre-to-centre distance depending on the door (**see surcharges on page 35**)

CARCASSES

standard: melamine-faced oriental pearl (opt.940), ivory (opt.930) back panel and shelf

on request: melamine-coated white (opt.001), white back panel and shelf (opt.001)
 melamine-faced mink (opt.948M), white (opt.001) back panel and shelf
 melamine-faced devalè with grafis finish (opt.796), white (opt.001) back panel and shelf

standard for PEWTER door: melamine-faced mink (opt.948M), white (opt.001) back panel and shelf

SHELVES

standard: height 3.8 cm, laminate in the colours white (opt.001), oriental pearl (opt.940), mink (opt.948M), devalè with grafis finish (opt.796)

on request: height 3.8 cm lacquered, for the finishes see door colour

PLINTHS

standard: height 15 cm, melamine-faced pvc with steel finish (opt.407)

on request: height 15 cm, melamine-faced pvc with satin aluminium finish (opt.405)
 height 15 cm, white melamine-faced pvc (opt.001)
 height 15 cm, aluminium with brill finish (opt.412), semi-glossy white (opt.A001), **see surcharges on page 36**
 height 15 cm, pewter lacquered pvc (opt.L9549), **see surcharges on page 36**

kyra laccato lacquered

cod. **K28** PREZZI FASCIA "A" CATEGORY "A" PRICES

ante doors

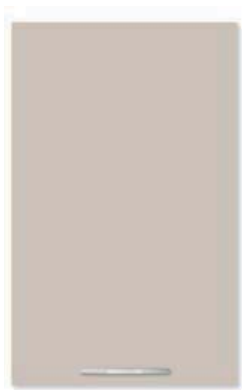

tortora opaco (opz.8991)
matt dove grey (opt.8991)



cestone tortora opaco (opz.8991)
matt dove grey deep drawer
(opt.8991)



cassetto tortora opaco (opz.8991)
matt dove grey drawer (opt.8991)

SP. 20 MM TH. 20 MM

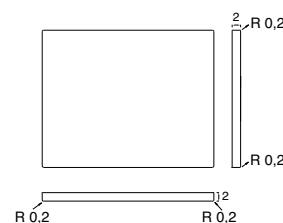

di serie: ante vetro telaio alluminio brill
standard: glass doors with brill aluminium frame



anta telaio alluminio brill,
con maniglia incorporata L 160 mm
vetro satinato (opz.419S)
door with aluminium frame brill finish
with incorporated handle W 160 mm,
satin glass (opt.419S)

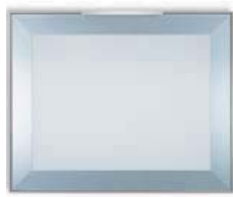

cestone vetro telaio alluminio finitura brill,
con maniglia incorporata L 160 mm
vetro satinato (opz.419S)
door deep drawer with aluminium frame
with incorporated handle W 160 mm,
brill finish, satin glass (opt.419S)

a richiesta: ante vetro effetto vintage **NEW**
on request: vintage effect glass door



telaio in mdf laccato peltro,
vetro retinato (opz.9549)
mdf frame with pewter finish,
wired glass (opt.9549)

N.B.: maniglia consigliata cod.K02
Note: handle advised cod.K02



cestone vetro telaio in mdf
laccato peltro,
vetro retinato (opz.9549)
glass deep drawer mdf frame
with pewter finish,
wired glass (opt.9549)

SP. 20 MM TH. 20 MM

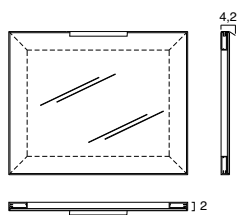

SP. 20 MM TH. 20 MM

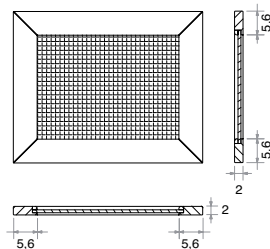

kyra laccato lacquered

cod. **K28**

PREZZI FASCIA "A" CATEGORY "A" PRICES

ante laccato opaco finitura soft, retro laccato opaco in tinta
matt lacquered doors with soft finish, rear with matching matt lacquered finish

 colori in pronta consegna
available colours

NEW

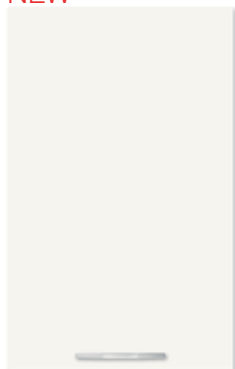

bianco caldo
(opz.7401)
warm white (opt.7401)



tortora
(opz.8991)
dove grey (opt.8991)



visone
(opz.946S)
mink (opt.946S)

NEW



fango
(opz.8905)
mud (opt.8905)

ante laccato lucido finitura lucido diretto, retro laccato opaco in tinta
glossy lacquered doors with direct finish, rear with matching matt lacquered finish

 colori in pronta consegna
available colours

NEW



bianco caldo
(opz.7402)
warm white (opt.7402)



tortora
(opz.8992)
dove grey (opt.8992)



visone
(opz.947)
mink (opt.947)

NEW



fango
(opz.8906)
mud (opt.8906)

kyra laccato lacquered

cod. **K28** PREZZI FASCIA "B" CATEGORY "B" PRICES

ante laccato opaco finitura soft, retro laccato opaco in tinta
 matt lacquered doors with soft finish, rear with matching matt lacquered finish



verde lichene (opz.8463)
 green lichene (opt.8463)



cestone verde lichene (opz.8463)
 green lichene deep drawer
 (opt.8463)



cassetto verde lichene (opz.8463)
 green lichene drawer (opt.8463)

SP. 20 MM TH. 20 MM

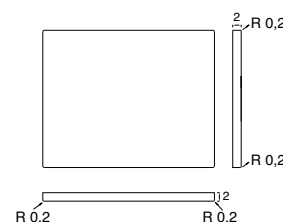

di serie: ante vetro telaio alluminio brill
 standard: glass doors with brill aluminium frame



anta telaio alluminio brill,
 con maniglia incorporata L 160 mm
 vetro satinato (opz.419S)
 door with aluminium frame brill finish
 with incorporated handle W 160 mm,
 satin glass (opt.419S)

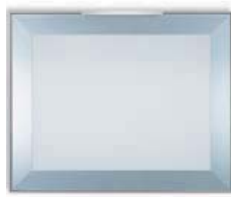

cestone vetro telaio alluminio finitura brill,
 con maniglia incorporata L 160 mm
 vetro satinato (opz.419S)
 door deep drawer with aluminium frame
 with incorporated handle W 160 mm,
 brill finish, satin glass (opt.419S)

a richiesta: ante vetro effetto vintage **NEW**
 on request: vintage effect glass door



telaio in mdf laccato peltro,
 vetro retinato (opz.9549)
 mdf frame with pewter finish,
 wired glass (opt.9549)

N.B.: maniglia consigliata cod.K02
 Note: handle advised cod.K02



cestone vetro telaio in mdf
 laccato peltro,
 vetro retinato (opz.9549)
 glass deep drawer mdf frame
 with pewter finish,
 wired glass (opt.9549)

SP. 20 MM TH. 20 MM

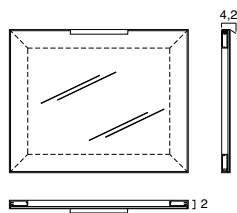

SP. 20 MM TH. 20 MM

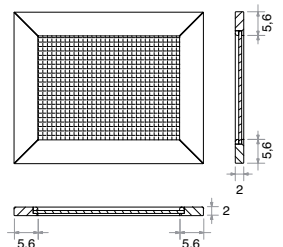

kyra laccato lacquered

cod. **K28**

PREZZI FASCIA "B" CATEGORY "B" PRICES

colori opachi finitura soft, retro laccato opaco in tinta
matt colours with soft finish, rear with matching matt lacquered finish

<p>bianco assoluto opaco (opz.740S) matt absolute white</p>	<p>cenere opaco (opz.9547) matt ash</p>	<p>verde provenza opaco (opz.8465) matt provence green</p>	<p>titanio opaco (opz.9545) matt titanium</p>	<p>cappuccino opaco (opz.7771) matt cappuccino</p>	<p>caffè opaco (opz.887S) matt coffee</p>	<p>verde lichene opaco (opz.8463) matt green lichen</p>
<p>rosa quarzo opaco (opz.8181) matt quartz pink</p>	<p>lavanda opaco (opz.9141) matt lavender</p>	<p>blu laguna opaco (opz.8365) matt lagoon blue</p>	<p>avorio opaco (opz.767S) matt ivory</p>	<p>rosso opaco (opz.125S) matt red</p>	<p>rubino opaco (opz.8151) matt ruby</p>	<p>lavagna opaco (opz.9543) matt slate grey</p>
<p>lime opaco (opz.8461) matt lime</p>	<p>giallo ambra opaco (opz.327S) matt amber yellow</p>	<p>oro vecchio opaco (opz.933S) matt old gold</p>	<p>mandarino opaco (opz.8155) matt mandarin</p>	<p>blu oltremare opaco (opz.922S) matt ultramarine</p>	<p>prugna opaco (opz.8631) matt plum</p>	<p>grigio perla opaco (opz.9555) matt pearl grey</p>
<p>grigio argento opaco (opz.9541) matt silver grey</p>	<p>lilla opaco (opz.392S) matt lilac</p>	<p>glicine opaco (opz.920S) matt wisteria</p>	<p>blu aviazione opaco (opz.8363) matt aviation blue</p>	<p>nero assoluto opaco (opz.786S) matt absolute black</p>		

colori a campione RAL maggiorazione del 35% rispetto alla fascia A
RAL sample colours with 35% surcharge more than category A

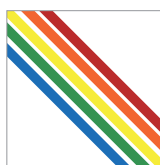

colore a campione RAL (opz.998)
RAL sample colours

CONSEGNA: MINIMO 5 SETTIMANE DALLA CONFERMA DELL' ORDINE
DELIVERY: MINIMUM 5 WEEKS FROM ORDER CONFIRMATION

kyra laccato lacquered

cod. **K28** PREZZI FASCIA "B" CATEGORY "B" PRICES

ante laccato lucido finitura lucido diretto, retro laccato opaco in tinta
glossy lacquered doors with direct finish, rear with matching matt lacquered finish



blu aviazione (opz.8364)
aviation blue (opt.8364)



cestone blu aviazione (opz.8364)
aviation blue deep drawer (opt.8364)



cassetto blu aviazione (opz.8364)
aviation blue drawer (opt.8364)

SP. 20 MM TH. 20 MM

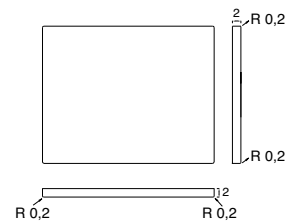

di serie: ante vetro telaio alluminio brill
standard: glass doors with brill aluminium frame



anta telaio alluminio brill,
con maniglia incorporata L 160 mm
vetro satinato (opz.419S)
door with aluminium frame brill finish
with incorporated handle W 160 mm,
satin glass (opt.419S)



cestone vetro telaio alluminio finitura brill,
con maniglia incorporata L 160 mm
vetro satinato (opz.419S)
door deep drawer with aluminium frame
with incorporated handle W 160 mm,
brill finish, satin glass (opt.419S)

a richiesta: ante vetro effetto vintage **NEW**
on request: vintage effect glass door



telaio in mdf laccato peltro,
vetro retinato (opz.9549)
mdf frame with pewter finish,
wired glass (opt.9549)



N.B.: maniglia consigliata cod.K02
Note: handle advised cod.K02

cestone vetro telaio in mdf
laccato peltro,
vetro retinato (opz.9549)
glass deep drawer mdf frame
with pewter finish,
wired glass (opt.9549)

SP. 20 MM TH. 20 MM

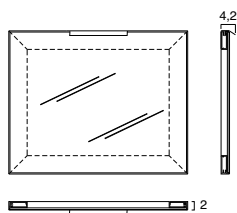

SP. 20 MM TH. 20 MM

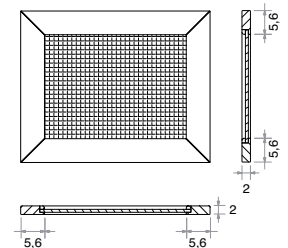

kyra laccato lacquered

cod. **K28**

PREZZI FASCIA "B" CATEGORY "B" PRICES

colori lucidi finitura lucido diretto, retro laccato opaco in tinta
glossy colours with direct finish, rear with matching matt lacquered finish

<p>bianco assoluto lucido (opz.741) glossy absolute white</p>	<p>cenere lucido (opz.9548) glossy ash</p>	<p>verde provenza lucido (opz.8466) glossy provence green</p>	<p>titanio lucido (opz.9546) glossy titanium</p>	<p>cappuccino lucido (opz.7772) glossy cappuccino</p>	<p>caffè lucido (opz.888) glossy coffee</p>	<p>verde lichene lucido (opz.8464) glossy green lichen</p>
<p>rosa quarzo lucido (opz.8182) glossy quartz pink</p>	<p>lavanda lucido (opz.9142) glossy lavender</p>	<p>blu laguna lucido (opz.8366) glossy lagoon blue</p>	<p>avorio lucido (opz.768) glossy ivory</p>	<p>rosso lucido (opz.126) glossy red</p>	<p>rubino lucido (opz.8152) glossy ruby</p>	<p>lavagna lucido (opz.9544) glossy slate grey</p>
<p>lime lucido (opz.8462) glossy lime</p>	<p>giallo ambra lucido (opz.328) glossy amber yellow</p>	<p>oro vecchio lucido (opz.934) glossy old gold</p>	<p>mandarino lucido (opz.8156) glossy mandarin</p>	<p>blu oltremare lucido (opz.923) glossy ultramarine</p>	<p>prugna lucido (opz.8632) glossy plum</p>	<p>grigio perla lucido (opz.9556) glossy pearl grey</p>
<p>grigio argento lucido (opz.9542) glossy silver grey</p>	<p>lillà lucido (opz.393) glossy lilac</p>	<p>glicine lucido (opz.921) glossy wisteria</p>	<p>blu aviazione lucido (opz.8364) glossy aviation blue</p>	<p>nero assoluto lucido (opz.787) glossy absolute black</p>		

colori a campione RAL maggiorazione del 35% rispetto alla fascia A
RAL sample colours with 35% surcharge more than category A

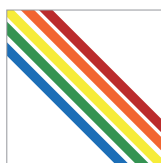

colore a campione RAL (opz.998)
RAL sample colours

CONSEGNA: MINIMO 5 SETTIMANE DALLA CONFERMA DELL' ORDINE
DELIVERY: MINIMUM 5 WEEKS FROM ORDER CONFIRMATION

kyra laccata peltro pewter lacquered

cod. **K28**

ante doors **NEW**



peltro (opz.9549)
pewter (opt.9549)



cestone peltro (opz.9549)
pewter deep drawer (opt.9549)



cassetto peltro (opz.9549)
pewter drawer (opt.9549)

SP. 20 MM TH. 20 MM

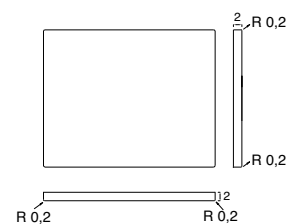

ante vetro glass doors **NEW**



telaio in mdf laccato peltro, vetro retinato (opz.9549)
mdf frame with pewter finish, wired glass (opt.9549)

N.B.: maniglia consigliata cod.K02
Note: handle advised cod.K02



cestone vetro telaio in mdf laccato peltro, vetro retinato (opz.9549)
glass deep drawer mdf frame with pewter finish, wired glass (opt.9549)

SP. 20 MM TH. 20 MM

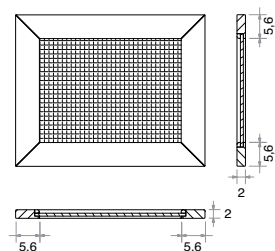



CARATTERISTICHE TECNICHE

ANTE E FRONTALI CASSETTI	<p>anta in MDF sp.20 mm lato esterno in acrilico opaco glaks sp.2 mm lato interno acrilico opaco stesso colore esterno sp.2 mm squadrata e bordata 4 lati, bordo in tinta 1 mm spigolata sui 4 lati effetto vetro nei colori opachi: glaks bianco (opz.7491), glaks fango (opz.8883), glaks blu giulietta (opz.8343), glaks mattone (opz.8143), glaks grigio reale (opz.9563), glaks rosa colorado (opz.8141)</p> <p>anta in MDF sp.20 mm lato esterno in acrilico lucido glaks sp.2 mm lato interno acrilico opaco stesso colore esterno sp.2 mm squadrata e bordata 4 lati, bordo in tinta 1 mm spigolata sui 4 lati effetto vetro nei colori lucidi: glaks bianco (opz.7492), glaks fango (opz.8884), glaks blu giulietta (opz.8344), glaks mattone (opz.8144), glaks grigio reale (opz.9564), glaks rosa colorado (opz.8142)</p>
MANIGLIE	<p>di serie: K50 finitura cromo passo mm 160/320 in funzione dell'anta</p> <p>a richiesta: K54 finitura cromo passo mm 64/160/320* in funzione dell'anta (*maggiorazione € 5 cad.) F466 finitura cromo passo mm 160 F499 finitura cromo passo mm 160 F497 finitura cromo passo mm 160 477 finitura cromo passo mm 64/160/320* in funzione dell'anta (*maggiorazione € 7 cad.) F482 finitura cromo passo mm 160 F463 finitura cromo passo mm 160 K01 finitura cromo passo mm 160 K52 finitura cromo passo mm 64/160/320 in funzione dell'anta K82 finitura nichel satinato passo mm 128 K10 finitura nichel satinato passo mm 128/320 in funzione dell'anta 412 pomo finitura nichel satinato passo mm 16 K02 finitura bronzo titanio passo mm 160 581 incassata finitura bronzo titanio passo mm 128 (maggiorazione € 8 cad.) 790C finitura brill montata in orizzontale passo in funzione dell'anta (vedi maggiorazioni pag.35) 790M finitura brown montata in orizzontale passo in funzione dell'anta (vedi maggiorazioni pag.35)</p>
STRUTTURE	<p>di serie: nobilitato bianco (opz.001), schiena e ripiano bianco (opz.001)</p> <p>a richiesta: nobilitato perla d'oriente (opz.940), schiena e ripiano avorio (opz.930) nobilitato visone (opz.948M) schiena e ripiano bianco (opz.001)</p>
MENSOLE	<p>altezza 3,8 cm in laminato bianco (opz.001), perla d'oriente (opz.940), visone (opz.948M)</p>
ZOCCOLI	<p>di serie: altezza 15 cm in pvc ricoperti in melamina finitura acciaio (opz.407)</p> <p>a richiesta: altezza 15 cm in pvc ricoperti in melamina colore alluminio satinato (opz.405) altezza 15 cm in pvc ricoperti in melamina bianco (opz.001) altezza 15 cm in alluminio finitura brill (opz.412), bianco semilucido (opz.A001), vedi maggiorazioni pag.36</p>



TECHNICAL SPECIFICATIONS

DOORS AND DRAWERS FRONTS

MDF door, Th. 20 mm, 2 mm thick glaks matt acrylic exterior, 2 mm matt acrylic interior same colour as exterior, square-shaped and edged on 4 sides with 1 mm matching edge, sharp edge on 4 sides, glass effect in the following matt colours:
glaks white (opt.7491), glaks mud (opt.8883), glaks juliet blue (opt.8343), glaks brick (opt.8143), glaks real grey (opt.9563), glaks colorado pink (opt.8141)

MDF door, Th. 20 mm, 2 mm thick glossy glaks acrylic exterior, 2 mm matt acrylic interior same colour as exterior, square-shaped and edged on 4 sides with 1 mm matching edge, sharp edge on 4 sides, glass effect in the following glossy colours:
glaks white (opt.7492), glaks mud (opt.8884), glaks juliet blue (opt.8344), glaks brick (opt.8144), glaks real grey (opt.9564), glaks colorado pink (opt.8142)

HANDLES

standard: K50 chrome finish, 160/320 mm centre-to-centre distance depending on the door

on request: K54 chrome finish, 64/160/320* mm centre-to-centre distance depending on the door (*surcharge € 5 each)
F466 chrome finish, 160 mm centre-to-centre distance
F499 chrome finish, 160 mm centre-to-centre distance
F497 chrome finish, 160 mm centre-to-centre distance
477 chrome finish, 64/160/320* mm centre-to-centre distance depending on the door (*surcharge € 7 each)
F482 chrome finish with 160 mm centre-to-centre distance
F463 chrome finish, 160 mm centre-to-centre distance
K01 chrome finish, 160mm centre-to-centre distance
K52 chrome finish, 64/160/320 mm centre-to-centre distance depending on the door
K82 satin nickel finish, 128 mm centre-to-centre distance
K10 satin nickel finish centre-to-centre distance 128/320 mm depending on the door
412 knob with satin nickel finish, centre-to-centre distance 16 mm
K02 titanium bronze finish, 160 mm centre-to-centre distance
581 built-in bronze titanium finish, 128 mm centre-to-centre distance (surcharge € 8 each)
790C brill finish, horizontally mounted, centre-to-centre distance depending on the door (see surcharges on page 35)
790M brown finish, horizontally mounted, centre-to-centre distance depending on the door (see surcharges on page 35)

CARCASSES

standard: melamine-coated white (opt.001), white back panel and shelf (opt.001)

on request: melamine-faced oriental pearl (opt.940), ivory (opt.930) back panel and shelf
melamine-faced mink (opt.948M), white (opt.001) back panel and shelf

SHELVES

height 3.8 cm, laminate in the colours white (opt.001), oriental pearl (opt.940), mink (opt.948M)

PLINTHS

standard: height 15 cm, melamine-faced pvc with steel finish (opt.407)

on request: height 15 cm, melamine-faced pvc with satin aluminium finish (opt.405)
height 15 cm, white melamine-faced pvc (opt.001)
height 15 cm, aluminium with brill finish (opt.412), semi-glossy white (opt.A001), see surcharges on page 36

kyra glaks

cod. **K30**

ante acrilico effetto vetro, retro acrilico opaco in tinta

glass effect acrylic doors, rear with matching matt acrylic finish



anta mattone (opz.8143)
brick door (opt.8143)

cestone mattone (opz.8143)
brick deep drawer (opt.8143)

cassetto mattone (opz.8143)
brick drawer (opt.8143)

SP. 20 MM TH.20 MM

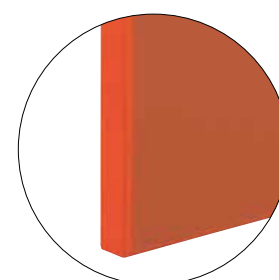
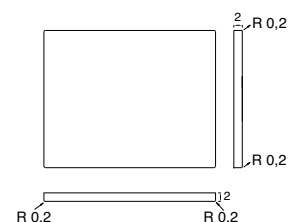

particolare anta
doors detail



glaks blu giulietta opaco (opz.8343)
lucido (opz.8344)
glaks juliet blue matt (opt.8343)
glossy (opt.8344)



glaks mattone opaco (opz.8143)
lucido (opz.8144)
glaks brick matt (opt.8143)
glossy (opt.8144)



glaks bianco opaco (opz.7491)
lucido (opz.7492)
glaks white matt (opt.7491)
glossy (opt.7492)



glaks fango opaco (opz.8883)
lucido (opz.8884)
glaks mud matt (opt.8883)
glossy (opt.8884)

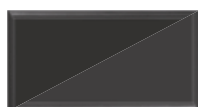

glaks grigio reale opaco (opz.9563)
lucido (opz.9564)
glaks real grey matt (opt.9563)
glossy (opt.9564)

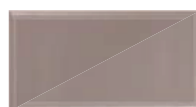

glaks rosa colorado opaco (opz.8141)
lucido (opz.8142)
glaks colorado pink matt (opt.8141)
glossy (opt.8142)

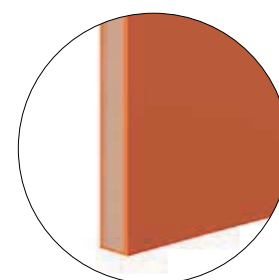

particolare anta sezionata
doors detail sectioned



kyra

MANIGLIE HANDLES

DI SERIE STANDARD



Maniglia K50 finitura cromo
anta da L 30 a L 45 → passo 160 mm
anta da L 60 a L 90 → passo 320 mm

Handle K50 chrome finish
door from W 30 to W 45 → centre-to-centre distance 160 mm
door from W 60 to W 90 → centre-to-centre distance 320 mm



Pomo 244P finitura cromo
solo per anta L 15 in abbinamento
alla maniglia K50

Knob 244P chrome finish
only for door W 15 in combination
to the handle K50

A RICHIESTA ON REQUEST



Maniglia K54 finitura cromo
anta L 15 → passo 64 mm
anta da L 30 a L 45 → passo 160 mm
anta da L 60 a L 90 → passo 320* mm
(*MAGGIORAZIONE 5 € CAD.)

Handle K54 chrome finish
door W 15 → centre-to-centre distance 64 mm
door from W 30 to W 45 → centre-to-centre distance 160 mm
door from W 60 to W 90 → centre-to-centre distance 320* mm
(*surcharge 5 € each)



Maniglia F466 finitura cromo
passo 160 mm
passo 64 mm solo per anta L 15

Handle F466 chrome finish
centre-to-centre distance 160 mm
centre-to-centre distance 64 mm for door W 15



Maniglia F499 finitura cromo
passo 160 mm
passo 64 mm solo per anta L 15

Handle F499 chrome finish
centre-to-centre distance 160 mm
centre-to-centre distance 64 mm for door W 15



Maniglia F497 finitura cromo
passo 160 mm
passo 64 mm solo per anta L 15

Handle F497 chrome finish
centre-to-centre distance 160 mm
centre-to-centre distance 64 mm for door W 15



Maniglia 477 finitura cromo
anta L 15 → passo 64 mm
anta da L 30 a L 45 → passo 160 mm
anta da L 60 a L 90 → passo 320* mm
(*MAGGIORAZIONE 7 € CAD.)

Handle 477 chrome finish
door W 15 → centre-to-centre distance 64 mm
door from W 30 to W 45 → centre-to-centre distance 160 mm
door from W 60 to W 90 → centre-to-centre distance 320* mm
(*surcharge 7 € each)



Maniglia F482 finitura cromo
passo 160 mm
passo 64 mm solo per anta L 15

Handle F482 chrome finish
centre-to-centre distance 160 mm
centre-to-centre distance 64 mm for door W 15



Maniglia F463 finitura cromo
passo 160 mm
passo 96 mm solo per anta L 15

Handle F463 chrome finish
centre-to-centre distance 160 mm
centre-to-centre distance 96 mm for door W 15



Maniglia K01 finitura cromo
passo 160 mm
passo 64 mm solo per anta L 15

Handle K01 chrome finish
centre-to-centre distance 160 mm
centre-to-centre distance 64 mm for door W 15



Maniglia K52 finitura cromo
anta L 15 → passo 64 mm
anta da L 30 a L 45 → passo 160 mm
anta da L 60 a L 90 → passo 320 mm

Handle K52 chrome finish
door W 15 → centre-to-centre distance 64 mm
door from W 30 to W 45 → centre-to-centre distance 160 mm
door from W 60 to W 90 → centre-to-centre distance 320 mm

kyra

MANIGLIE HANDLES

A RICHIESTA ON REQUEST



Maniglia K82 finitura nichel satinato
passo 128 mm

Handle K82 satin nickel finish
centre-to-centre distance 128 mm



Pomo K82P finitura nichel satinato
passo 32 mm
utilizzata per elementi da 15 con maniglia K82

Knob K82P satin nickel finish
centre-to-centre distance 32 mm
used for W 15 elements with handle K82

NEW



Maniglia K10 finitura nichel satinato
anta da L 15 maniglia in verticale → passo 128 mm
anta da L 30 a L 45 → passo 128 mm
anta da L 60 a L 90 → passo 320 mm

Handle K10 satin nickel finish
door from W 15 vertical handles → centre-to-centre distance 128 mm
door from W 30 to W 45 → centre-to-centre distance 128 mm
door from W 60 to W 90 → centre-to-centre distance 320 mm



Pomo 412 finitura nichel satinato
passo 16 mm

Knob 412 satin nickel finish
centre-to-centre distance 16 mm

NEW



Maniglia K02 finitura bronzo titanio
passo 160 mm
passo 96 mm solo per anta L 15

Handle K02 finish titanium bronze
centre-to-centre distance 160 mm
centre-to-centre distance 96 mm for door W 15

NEW



Maniglia incassata 581 finitura bronzo titanio
anta L 15 → passo 64 mm
anta da L 30 a L 120 → passo 128 mm
(MAGGIORAZIONE 8 € CAD.)

Built-in handle 581 titanium bronze finish
door W 15 → centre-to-centre distance 64 mm
door from W 30 to W 120 → centre-to-centre distance 128 mm
(surcharge 8 € each)



Maniglia 790C finitura brill
passo in funzione dell'anta
vedi schema tecnico pag.35

Handle 790C brill finish
centre-to-centre distance varies according to the door
see technical diagram on page 35



Maniglia 790M finitura brown opaco
passo in funzione dell'anta
vedi schema tecnico pag.35

Handle 790M matt brown finish
centre-to-centre distance varies according to the door
see technical diagram on page 35

SCHEMA MANIGLIE OPZ.790C - 790M HANDLES DIAGRAM CODES 790C - 790M

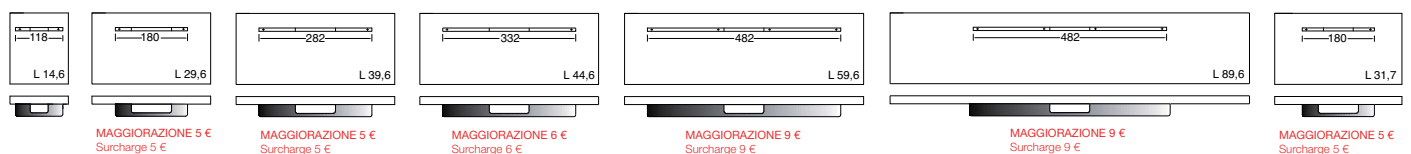

kyra

strutture carcasses



bianco (opz.001)
schiena e ripiano bianco
(opz.001)
white (opt.001)
white back panel and shelf
(opt.001)



perla d'oriente (opz.940)
schiena e ripiano avorio
(opz.930)
oriental pearl (opt.940)
ivory back panel and shelf
(opt.930)



visone (opz.948M)
schiena e ripiano bianco
(opz.001)
mink (opt.948M)
white back panel and shelf
(opt.001)



devalè finitura grafis
(opz.796) schiena e ripiano
bianco (opz.001)
devalè with grafis finish
(opt.796)
white back panel and shelf
(opt.001)



rovere cenere (opz.261)
schiena e ripiano bianco
(opz.001)
ash oak (opt.261)
white back panel and shelf
(opt.001)



larice moro (opz.218)
schiena e ripiano bianco
(opz.001)
dark larch (opt.218)
white back panel and shelf
(opt.001)



CREO ECOLOGIC

IL GRUPPO LUBE HA SCELTO DI UTILIZZARE PER I COMPONENTI COSTITUENTI LE STRUTTURE DELLE CUCINE SOLO MATERIALE A BASSISSIMA EMISSIONE DI FORMALDEIDE: CONFORMI ALLO STANDARD F4 STAR SECONDO LA NORMA JIS, CERTIFICATO DAL MINISTERO GIAPPONESE, IL PIU' SEVERO IN MERITO ALLE NORMATIVE DI SALVAGUARDIA AMBIENTALE.

LUBE GROUP HAS CHOSEN TO EXCLUSIVELY USE MATERIALS WITH VERY LOW FORMALDEHYDE EMISSIONS FOR THE COMPONENTS MAKING UP THE KITCHEN CARCASSES: THESE ELEMENTS COMPLY WITH THE F4 STAR STANDARD ACCORDING TO JIS, CERTIFIED BY THE JAPANESE GOVERNMENT - THE MOST STRINGENT WHEN IT COMES TO ENVIRONMENTAL PROTECTION.

zoccoli in pvc H 15 pvc plinths H 15



acciaio (opz.407)
steel (opt.407)



alluminio satinato
(opz.405)
satin aluminium
(opt.405)



bianco (opz.001)
white (opt.001)

zoccoli in pvc H 15 laccato peltro pvc plinths H 15 pewter lacquered



laccato peltro
(opz.L9549)
pewter lacquered
(opt.L9549)

**magg. rispetto allo zoccolo standard
surcharges compared to standard plinth**

al ml
per lm

cod.092156
code

+35 €

zoccoli in alluminio H 15 aluminium plinths H 15



alluminio
finitura brill (opz.412)
aluminium with
brill finish (opt.412)



alluminio bianco
semilucido (opz.A001)
semi-polished white
aluminium (opt.A001)

**magg. rispetto allo zoccolo standard
surcharges compared to standard plinth**

al ml
per lm

cod.092155
code

+20 €

kyra

mensole in laminato laminated shelves



bianco (opz.001)
white (opt.001)



perla d'oriente (opz.940)
oriental pearl (opt.940)



visone (opz.948M)
mink (opt.948M)



devalè finitura grafis
(opz.796)
devalè with grafis finish (opt.796)



rovere cenere (opz.261)
ash oak (opt.261)



larice moro (opz.218)
dark larch (opt.218)

mensole in laminato come ante melaminico laminated shelves same as melamine doors



rovere bianco spazzolato
(opz.5311)
brushed white oak (opt.5311)



rovere cipria spazzolato
(opz.5312)
brushed powder oak (opt.5312)



abete nordico bianco
(opz.4406)
white nordic fir (opt.4406)



abete nordico terra (opz.4407)
earth nordic fir (opt.4407)



rovere naturale vintage
(opz.5310)
vintage natural oak (opt.5310)

mensole laccate lacquered shelves

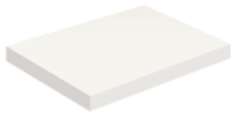

bianco caldo (opz.7401)
warm white (opt.7401)

per le finiture vedi ante pag.23-25-27
for the finishes see doors on page 23-25-27

mensole polimerico polymeric shelves



per le finiture vedi ante pag.17-19
for the finishes see doors on page 17-19

mensole in polimerico nei colori degli elementi a giorno polymeric shelves same colours as open units



acquamarina (opz.8323)
acquamarine (opt.8323)

COLORI COLOURS

bruno antilope
(opz.9451)
antelope brown

acquamarina
(opz.8323)
acquamarine

giallo ambr
(opz.8225)
amber yellow

rosa quarzo
(opz.8171)
quartz pink

rosso corallo
(opz.8131)
coral red

salvia
(opz.8443)
sage

vulcano
(opz.9615)
volcano

kyra

top H 4 consigliati in laminato bordo postformato recommended laminate worktops H 4 with post-formed edge



top H 4 consigliati in laminato bordo ABS 1 recommended laminate worktops H 4 with ABS 1 edge

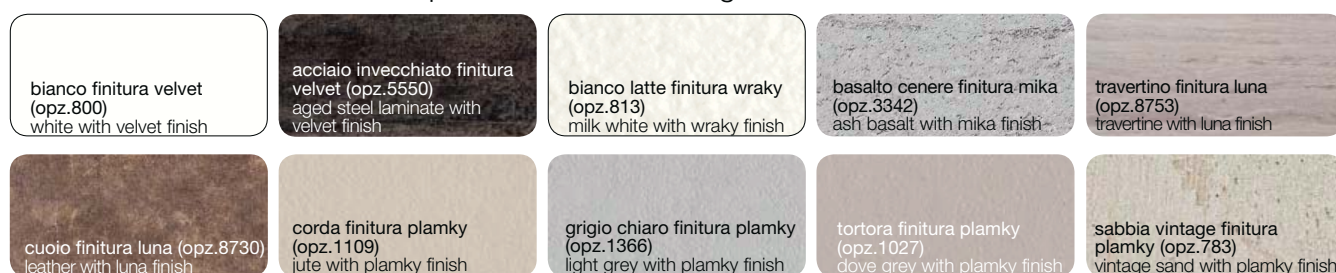

consigli per abbinamento dei colori

recommended colour combinations

ante

doors



rovere cipria spazzolato
(opz.5312)
brushed powder oak
(opt.5312)



rovere bianco spazzolato
(opz.5311)
brushed white oak
(opt.5311)



verde lichene lucido
(opz.8464)
green lichen
glossy (opt.8464)



abete nordico bianco
(opz.4406)
white nordic fir (opt.4406)



fango lucido (opz.8906)
mud glossy (opt.8906)



frassino dakar (opz.2412)
dakar ash (opt.2412)

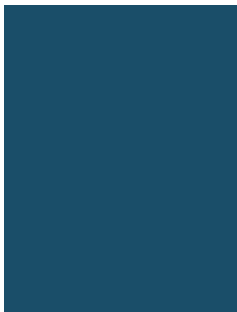

blu petrolio (opz.8325)
petroleum blue (opt.8325)

elementi a giorno

open units



bruno antilope (opz.9451)
antelope brown (opt.9451)



rosa quarzo (opz.8171)
quartz pink (opt.8171)

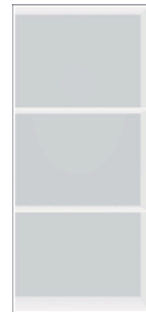

bianco assoluto (opz.740P)
absolute white (opt.740P)

top

worktops

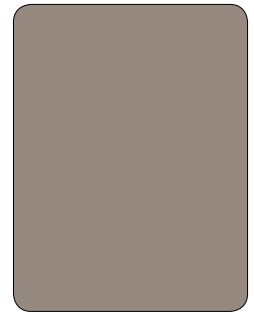

top laminato fenix
castoro (opz.0717)
laminato fenix worktop
beaver (opt.0717)

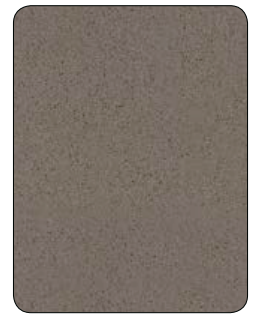

top quarzo new titan
lucido (opz.T208)
quartz worktop
new titan glossy (opt.T208)



top betacryl classic white
(opz.B100)
betacryl worktop
classic white (opt.B100)

consigli per abbinamento dei colori
recommended colour combinations

ante
doors



abete nordico terra
(opt.4407)
earth nordic fir (opt.4407)

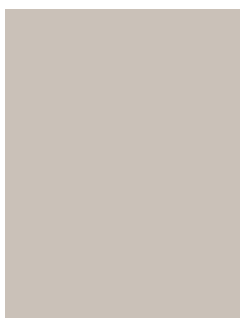

tortora opaco
(opt.8991)
dove grey matt (opt.8991)



rovere naturale vintage
(opt.5310)
vintage natural oak
(opt.5310)

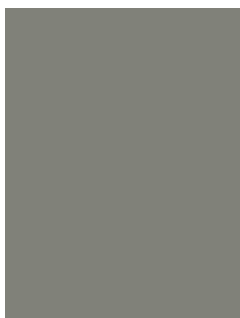

verde lichene (opt.8441)
lichen green (opt.8441)

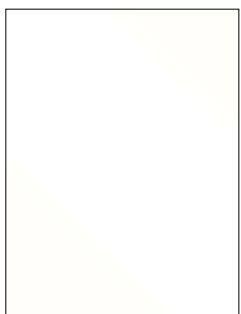

glaks bianco lucido
(opt.7492)
glaks white glossy
(opt.7492)



glaks rosa colorado lucido
(opt.8142)
glaks colorado pink glossy
(opt.8142)

elementi a giorno
open units



bruno antilope (opt.9451)
antelope brown (opt.9451)

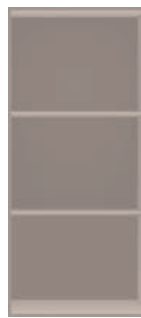

bruno antilope (opt.9451)
antelope brown (opt.9451)

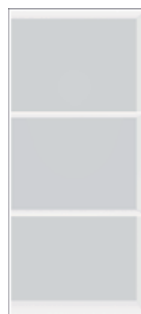

bianco assoluto (opt.740P)
absolute white (opt.740P)

top
worktops



top quarzo lucido
ashen light breeze (opt.T206)
quarzo worktop glossy
ashen light breeze (opt.T206)



top light brown (opt.L003)
light worktop brown (opt.L003)

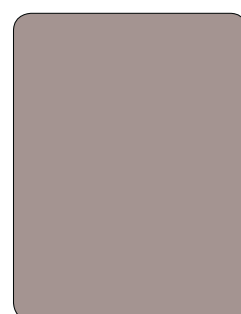

top laminato fenix
rosa colorado (opt.0716)
laminated fenix worktop
colorado pink (opt.0716)

consigli per abbinamento dei colori recommended colour combinations

ante doors



rovere naturale vintage
(opz.5310)
vintage natural oak
(opt.5310)



peltro (opz.9549)
pewter (opt.9549)



celeste alpaca lucido
(opz.8322)
glossy alpaca light blue
(opt.8322)



kaschmir opaco (opz.7713)
matt kaschmir (opt.7713)



rovere cipria spazzolato
(opz.5312)
brushed powder oak
(opt.5312)

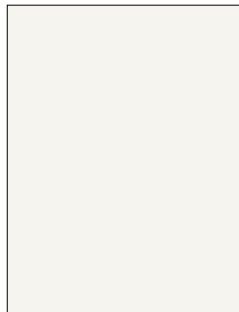

bianco caldo opaco (opz.7401)
matt warm white (opt.7401)

elementi a giorno open units



salvia (opz.8443)
sage green (opt.8443)



bruno antilope (opz.9451)
antelope brown (opt.9451)



salvia (opz.8443)
sage green (opt.8443)

top worktops



top laminato acciaio
invecchiato finitura velvet
(opz.5550)
laminato worktop aged steel
laminato with velvet finish
(opt.5550)



top quarzo lucido
ashen light breeze (opz.T206)
quarzo worktop glossy
ashen light breeze (opt.T206)



top laminato ABS1 travertino
beige finitura plamky
(opz.5548)
laminato ABS1 worktop beige
travertine with plamky finish
(opt.5548)



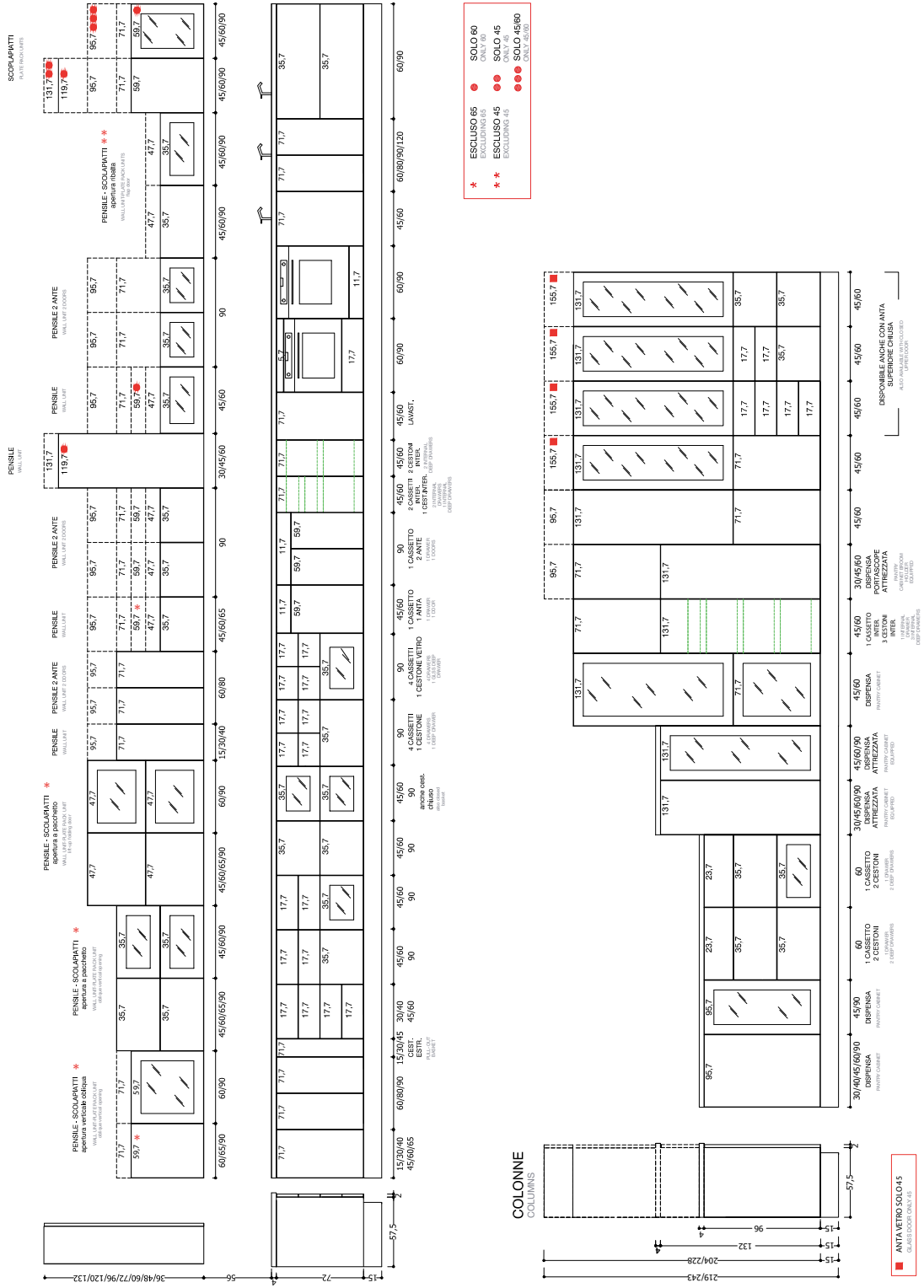



MODULARITÀ E COMPONIBILITÀ MODULARITY AND FITTING SOLUTIONS



PENSILI

WALL UNITS

P 33,2

	COD.	MELA-MINICO	POLIMERICO		LACCATO			GLAKS	
		K26	OPACO K27	LUCIDO K27	A K28	B K28	PELTRO K28	K30	
 <p>1 anta H 36 1 door H 36</p>	L 45	E2030451/2	78	83	88	85	94	107	130
	L 60	E2030601/2	87	93	100	97	110	127	145
	L 65	E2030651/2	100	107	113	111	124	143	170
 <p>1 anta H 48 1 door H 48</p>	L 45	E2040451/2	94	99	105	103	115	132	158
	L 60	E2040601/2	104	113	121	119	135	159	180
	L 65	E2040651/2	118	127	136	136	153	178	211
 <p>1 anta H 60 1 door H 60</p>	L 45	E2060451/2	99	108	116	114	129	151	171
	L 60	E2060601/2	112	124	134	135	155	184	197
	L 60	E2055601/2	112	124	134	135	155	184	197
 <p>1 anta H 72 1 door H 72</p>	L 15	E2010151/2	81	80	84	84	92	106	124
	L 30	E2010301/2	91	97	103	101	113	130	152
	L 40	E2010401/2	101	110	118	116	132	156	177
	L 45	E2010451/2	105	115	124	123	141	168	188
	L 60	E2010601/2	118	134	145	146	169	207	218
	L 65	E2010651/2	132	149	161	167	193	229	253
 <p>1 anta H 96 1 door H 96</p>	L 15	E2020151/2	93	94	99	99	109	116	140
	L 30	E2020301/2	109	117	125	124	139	163	180
	L 40	E2020401/2	121	133	144	145	167	197	216
	L 45	E2020451/2	126	141	152	153	177	214	232
	L 60	E2020601/2	147	169	183	187	219	269	278
	L 65	E2020651/2	161	186	201	210	245	294	321
 <p>1 anta H 120 1 door H 120</p>	L 60	E2145601/2	204	237	255	262	303	360	364
 <p>1 anta H 132 1 door H 132</p>	L 30	E2141301/2	170	182	193	196	219	248	279
	L 45	E2141451/2	190	213	228	236	270	315	341
	L 60	E2141601/2	215	247	266	275	318	387	399

PENSILI

WALL UNITS

P 33,2

N.B.: cerniere ammortizzate di serie
Note: standard blumotion hinges

	COD.	MELA-MINICO	POLIMERICO		LACCATO			GLAKS	
		K26	OPACO K27	LUCIDO K27	A K28	B K28	PELTRO K28	K30	
 <p>2 ante H 36 2 doors H 36</p>	L 90	E2030900	130	139	149	143	161	186	233
	L 90	E2040900	155	166	178	173	197	232	285
 <p>2 ante H 60 2 doors H 60</p>	L 90	E2060900	162	182	197	193	223	268	307
	L 60	E2010600	146	158	171	165	190	224	269
 <p>2 ante H 72 2 doors H 72</p>	L 80	E2010800	166	184	200	197	229	277	319
	L 90	E2010900	174	196	214	212	247	302	341
	L 60	E2020600	175	191	207	204	236	283	317
 <p>2 ante H 96 2 doors H 96</p>	L 80	E2020800	199	224	245	248	291	352	389
	L 90	E2020900	210	240	263	264	311	386	421
	H 72 L 15	E2010150	140	141	144	143	151	165	183
 <p>cestello estraibile pull-out basket unit soft-closing system</p>	H 96 L 15	E2020150	164	165	170	170	180	186	211
	H 60	E2790000	50	62	70	88	109	114	107
 <p>fascia tamponamento L da 3 a 10 filler panel size from 3 to 10</p>	H 72	E2800000	50	62	70	88	109	114	107
	H 96	E2810000	56	80	89	113	138	143	131
	H 60	E2790000	50	62	70	88	109	114	107
 <p>Maggiorazione per apertura senza maniglia Surcharge for opening without handle</p>									
			+ 10	+ 10	+ 10	+ 10	+ 10	+ 10	+ 10
			+ 10	+ 10	+ 10	+ 10	+ 10	+ 10	+ 10
			+ 20	+ 20	+ 20	+ 20	+ 20	+ 20	+ 20





PENSILI-SCOLAPIATTI
CAPPE
WALLUNITS-RAE
PACK UNITS-HOODS

PENSILI

WALL UNITS

P 33,2

N.B.: cerniere ammortizzate di serie
Note: standard blumotion hinges









	COD.	MELAMINICO	POLIMERICO		LACCATO			GLAKS	
		K26	OPACO K27	LUCIDO K27	A K28	B K28	PELTRO K28	K30	
 <p>1 anta vetro H 36 1 glass door H 36</p>									
	telaio peltro-polimerico L 45 pewter-polymeric frame	E1030451/2	166	148	150	166	166	166	—
	L 60	E1030601/2	203	160	161	203	203	203	—
	telaio alluminio 419S L 45 aluminium frame	E1032451/2	165	165	165	165	165	165	—
L 60	E1032601/2	189	189	189	189	189	189	—	
 <p>1 anta vetro H 48 1 glass door H 48</p>									
	telaio peltro-polimerico L 45 pewter-polymeric frame	E1040451/2	198	168	169	198	198	198	—
	L 60	E1040601/2	245	192	195	245	245	245	—
	telaio alluminio 419S L 45 aluminium frame	E1042451/2	188	188	188	188	188	188	—
L 60	E1042601/2	211	211	211	211	211	211	—	
 <p>1 anta vetro H 60 1 glass door H 60</p>									
	telaio peltro-polimerico L 60 pewter-polymeric frame	E1060601/2	260	203	208	260	260	260	—
telaio alluminio 419S L 60 aluminium frame	E1062601/2	221	221	221	221	221	221	—	
 <p>1 anta vetro H 72 1 glass door H 72</p>									
	telaio peltro-polimerico L 45 pewter-polymeric frame	E1010451/2	245	184	188	245	245	245	—
	L 60	E1010601/2	299	218	225	299	299	299	—
	telaio alluminio 419S L 45 aluminium frame	E1012451/2	209	209	209	209	209	209	—
L 60	E1012601/2	237	237	237	237	237	237	—	
 <p>1 anta vetro H 96 1 glass door H 96</p>									
	telaio peltro-polimerico L 45 pewter-polymeric frame	E1020451/2	310	222	229	310	310	310	—
	telaio alluminio 419S L 45 aluminium frame	E1022451/2	249	249	249	249	249	249	—
L 60	E1022601/2	286	286	286	286	286	286	—	

PENSILI

WALL UNITS

P 33,2







N.B.: cerniere ammortizzate di serie
Note: standard blumotion hinges

	COD.	MELAMINICO	POLIMERICO		LACCATO			GLAKS
		K26	OPACO K27	LUCIDO K27	A K28	B K28	PELTRO K28	K30
 <p>2 ante vetro H 36 2 glass doors H 36</p>								
	<p>telaio peltro-polimerico L 90 pewter-polymeric frame</p> <p>telaio alluminio 419S L 90 aluminium frame</p>	E1030900	302	267	269	302	302	302
 <p>2 ante vetro H 48 2 glass doors H 48</p>								
	<p>telaio peltro-polimerico L 90 pewter-polymeric frame</p> <p>telaio alluminio 419S L 90 aluminium frame</p>	E1040900	359	299	301	358	358	358
 <p>2 ante vetro H 72 2 glass doors H 72</p>								
	<p>telaio peltro-polimerico L 90 pewter-polymeric frame</p> <p>telaio alluminio 419S L 90 aluminium frame</p>	E1010900	455	334	342	455	455	455
 <p>2 ante vetro H 96 2 glass doors H 96</p>								
	<p>telaio peltro-polimerico L 90 pewter-polymeric frame</p> <p>telaio alluminio 419S L 90 aluminium frame</p>	E1020900	578	401	415	578	578	578
  <p>jolly pensile H 72 L da 10 a 30 colore come struttura jolly wall unit size 10 to 30 same colour as carcass</p>								
	<p>in nobilitato melamine coated</p>							
	<p>H 72</p>	E2700000	53	53	53	53	53	53
  <p>terminale 31x31 a giorno tipo "A" open end unit 31x31 type "A" same colour as carcass</p>								
	<p>in nobilitato melamine coated</p>							
	<p>H 72</p>	E2620310	62	62	62	62	62	62
	<p>H 96</p>	E2630310	79	79	79	79	79	79

PENSILI

WALL UNITS

P 33,2 - 47,2 - 59,7

	COD.	MELA-MINICO	POLIMERICO		LACCATO			GLAKS	
		K26	OPACO K27	LUCIDO K27	A K28	B K28	PELTRO K28	K30	
 <p>angolo H 72 1 anta diagonale corner unit H 72 1 diagonal door</p>	65X65	E2400651/2	176	187	196	195	213	240	260
	 <p>angolo H 96 1 anta diagonale corner unit H 96 1 diagonal door</p>	65X65	E2410651/2	208	223	234	235	258	295
 <p>angolo H 72 2 ante a libretto N.B.: fuori squadra realizzabili da 88° a 92° corner unit H 72 2 folding doors Note: out-of-plumb units available from 88° to 92°</p>		65X65	E2450651/2	225	235	248	244	270	307
	 <p>angolo H 96 2 ante a libretto N.B.: fuori squadra realizzabili da 88° a 92° corner unit H 96 2 folding doors Note: out-of-plumb units available from 88° to 92°</p>	65X65	E2460651/2	275	293	310	309	343	393
 <p>copriboiler H 72 1 anta boiler housing H 72 1 door</p>		L 60 P 33,2	E2150601/2	109	127	139	140	165	205
	L 60 P 47,2	E2160601/2	144	162	174	175	202	244	256
	L 60 P 59,7	E2170601/2	144	162	174	175	202	244	256
 <p>copriboiler H 96 1 anta boiler housing H 96 1 door</p>	L 60 P 33,2	E2210601/2	131	154	170	174	208	261	271
	L 60 P 47,2	E2220601/2	174	199	215	219	254	310	321
	L 60 P 59,7	E2230601/2	174	199	215	219	254	310	321

PENSILI RIBALTA CHIUSURA AMMORTIZZATA

P 33,2

FLAP DOOR WALL UNITS BLUMOTION CLOSING SYSTEM

PENSILE CON APERTURA A RIBALTA

Le ante aprendosi verso l'alto consentono di avere un' ampia visione d'insieme all'interno del mobile. In questo modo è possibile un comodo accesso agli oggetti contenuti al suo interno e, dal punto di vista ergonomico, molto vantaggioso. La regolazione della forza di apertura può essere impostata in modo esatto in base al peso del frontale. Grazie all'arresto progressivo le ante si fermano in qualsiasi posizione; in questo modo la maniglia è sempre facilmente raggiungibile. La chiusura è ammortizzata di serie.

WALL UNIT WITH FLAP DOOR

The doors that open upwards guarantee ample overall visibility inside the cabinet. In this way, all objects housed inside the cabinet can be comfortably accessed, making the system highly advantageous from an ergonomic perspective. The opening force can be adjusted precisely according to the weight of the front. The doors stop in any position thanks to the gradual stopping movement; in this way, the handle is always easily accessible. The closing movement is cushioned standard

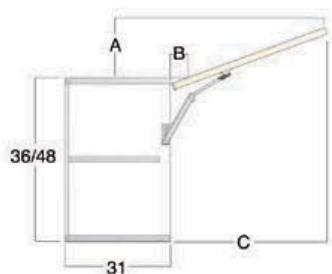





	A	B	C
H 36	7	4	37
H 48	11	4	49

PENSILI RIBALTA CHIUSURA AMMORTIZZATA

FLAP DOOR WALL UNITS BLUMOTION CLOSING SYSTEM





P 33,2

	COD.	MELAMINICO	POLIMERICO		LACCATO			GLAKS	
		K26	OPACO	LUCIDO	A	B	PELTRO	K30	
			K27	K27	K28	K28	K28		
anta ribalta H 36 flap door H 36 	L 45	E2100450	104	109	114	111	120	133	158
	L 60	E2100600	109	115	122	119	132	149	167
	L 65	E2100650	124	131	138	135	148	167	195
	L 90	E2100900	140	150	158	158	176	202	219
anta vetro ribalta H 36 glass flap door H 36 	telaio peltro-polimerico L 45 pewter-polymeric frame	E1100450	188	167	170	188	188	188	—
	L 60	E1100600	218	171	177	218	218	218	—
	L 90	E1100900	286	213	223	286	286	286	—
	telaio alluminio 419S L 45 aluminium frame	E1102450	178	178	178	178	178	178	—
	L 60	E1102600	196	196	196	196	196	196	—
	L 90	E1102900	247	247	247	247	247	247	—
anta ribalta H 48 flap door H 48 	L 45	E2120450	132	138	144	141	154	172	199
	L 60	E2120600	150	159	167	166	182	206	227
	L 65	E2120650	167	176	185	185	202	227	260
	L 90	E2120900	173	188	199	201	225	261	280
anta vetro ribalta H 48 glass flap door H 48 	telaio peltro-polimerico L 45 pewter-polymeric frame	E1120450	225	190	197	225	225	225	—
	L 60	E1120600	281	225	233	281	281	281	—
	L 90	E1120900	358	273	286	358	358	358	—
	telaio alluminio 419S L 45 aluminium frame	E1122450	207	207	207	207	207	207	—
	L 60	E1122600	243	243	243	243	243	243	—
	L 90	E1122900	287	287	287	287	287	287	—

PENSILI RIBALTA CHIUSURA AMMORTIZZATA

P 33,2





FLAP DOOR WALL UNITS BLUMOTION CLOSING SYSTEM

	COD.	MELAMINICO	POLIMERICO		LACCATO			GLAKS	
		K26	OPACO K27	LUCIDO K27	A K28	B K28	PELTRO K28	K30	
<p>pensile H 72 2 ante ribalta H 36 wall unit H 72 2 flap doors H 36</p> 	L 45	EP213450	189	199	209	203	221	247	296
	L 60	EP213600	200	212	225	220	245	279	316
	L 65	EP213650	218	232	245	241	266	305	360
	L 90	EP213900	255	274	292	290	326	380	412
<p>pensile H 72 2 ante ribalta vetro H 36 wall unit H 72 2 glass flap doors H 36</p> 									
	telaio petro-polimerico L 60 pewter-polymeric frame	EP214600	417	325	336	417	417	417	—
	L 90	EP214900	548	403	422	548	548	548	—
	telaio alluminio 419S L 60 aluminium frame	EP215600	373	373	373	373	373	373	—
L 90	EP215900	470	470	470	470	470	470	—	
<p>pensile H 72 1 anta chiusa ribalta superiore H 36 1 anta vetro ribalta inferiore H 36 wall unit H 72 1 full upper flap door H 36 1 glass lower flap door H 36</p> 									
	telaio petro-polimerico L 60 pewter-polymeric frame	EP216600	308	268	280	319	331	348	—
	L 90	EP216900	401	338	357	419	437	464	—
	telaio alluminio 419S L 60 aluminium frame	EP217600	286	293	299	297	309	326	—
L 90	EP217900	362	372	381	380	398	425	—	
<p>pensile H 72 1 anta vetro ribalta superiore H 36 1 anta chiusa ribalta inferiore H 36 wall unit H 72 1 glass upper flap door H 36 1 full lower flap door H 36</p> 									
	telaio petro-polimerico L 60 pewter-polymeric frame	EP218600	308	268	280	319	331	348	—
	L 90	EP218900	401	338	357	419	437	464	—
	telaio alluminio 419S L 60 aluminium frame	EP219600	286	293	299	297	309	326	—
L 90	EP219900	362	372	381	380	398	425	—	

PENSILI RIBALTA CHIUSURA AMMORTIZZAZIONE

P 33,2

FLAP DOOR WALL UNITS BLUMOTION CLOSING SYSTEM

	COD.	MELAMINICO	POLIMERICO		LACCATO			GLAKS	
		K26	OPACO K27	LUCIDO K27	A K28	B K28	PELTRO K28	K30	
 <p>pensile H 96 2 ante ribalta H 48 wall unit H 96 2 flap doors H 48</p>	L 45	EP223450	230	243	254	249	274	310	364
	L 60	EP223600	263	281	297	294	326	374	416
	L 65	EP223650	285	303	320	320	355	405	470
	L 90	EP223900	305	335	358	362	410	481	519
 <p>pensile H 96 2 ante ribalta vetro H 48 wall unit H 96 2 glass flap doors H 48</p>	telaio petro-polimerico L 60 pewter-polymeric frame	EP224600	526	412	429	526	526	526	—
	L 90	EP224900	665	497	522	665	665	665	—
	telaio alluminio 419S L 60 aluminium frame	EP225600	460	460	460	460	460	460	—
	L 90	EP225900	544	544	544	544	544	544	—
 <p>pensile H 96 1 anta chiusa ribalta superiore H 48 1 anta vetro ribalta inferiore H 48 wall unit H 96 1 full upper flap door H 48 1 glass lower flap door H 48</p>	telaio petro-polimerico L 60 pewter-polymeric frame	EP226600	394	347	363	410	426	450	—
	L 90	EP226900	485	416	440	514	538	573	—
	telaio alluminio 419S L 60 aluminium frame	EP227600	362	371	378	377	393	417	—
	L 90	EP227900	424	439	451	453	476	512	—
 <p>pensile H 96 1 anta vetro ribalta superiore H 48 1 anta chiusa ribalta inferiore H 48 wall unit H 96 1 glass upper flap door H 48 1 full lower flap door H 48</p>	telaio petro-polimerico L 60 pewter-polymeric frame	EP228600	394	347	363	410	426	450	—
	L 90	EP228900	485	416	440	514	538	573	—
	telaio alluminio 419S L 60 aluminium frame	EP229600	362	371	378	377	393	417	—
	L 90	EP229900	424	439	451	453	476	512	—

PENSILI A RIBALTA SENZA MANIGLIA APERTURA TIP-ON



P 33,2

FLAP DOOR WALL UNITS NO HANDLE TIP-ON OPENING



Grazie al meccanismo TIP-ON, le ante a ribalta senza maniglia possono essere aperte semplicemente con un leggero tocco. Per chiudere l'anta a ribalta, è sufficiente esercitare una leggera pressione, che grazie ad una piastrina di bloccaggio, applicata sul lato interno del frontale, ne assicura la perfetta chiusura.

Thanks to TIP-ON mechanism, the flap doors without handles can be opened with a simple touch. To close the flap door, just exercise light pressure, thanks to the locking plate, applied on the inner side of the front panel ensures a perfect closure.

	COD.	MELAMINICO	POLIMERICO		LACCATO			GLAKS	
		K26	OPACO K27	LUCIDO K27	A K28	B K28	PELTRO K28	K30	
anta ribalta TIP-ON H 36 flap door TIP-ON H 36 	L 45	E210046T	110	115	120	117	126	139	164
	L 60	E210061T	115	121	128	126	138	156	173
	L 65	E210066T	130	137	144	141	154	173	201
	L 90	E210091T	146	156	164	164	182	209	225
anta ribalta TIP-ON H 48 flap door TIP-ON H 48 	L 45	E212046T	138	144	150	147	160	178	205
	L 60	E212061T	156	165	173	172	188	212	233
	L 65	E212066T	173	182	191	191	208	233	266
	L 90	E212091T	179	194	205	207	231	267	286

PENSILI APERTURA VERTICALE OBLIQUA CHIUSURA BLUMOTION

P 33,2

WALL UNITS VERTICAL OBLIQUE OPENING AND BLUMOTION CLOSING SYSTEM

APERTURA VERTICALE OBLIQUA

I pensili con questo tipo di meccanismo necessitano per l'apertura di poco spazio libero sopra il mobile grazie al movimento basculante dell'anta che si apre senza difficoltà applicando poca forza anche in presenza di frontali pesanti. Con l'arresto progressivo le ante si fermano in qualsiasi posizione; in questo modo la maniglia è sempre facilmente raggiungibile. La chiusura è ammortizzata ed è possibile regolare la forza di tenuta in base al peso del frontale.

VERTICAL OPENING OBLIQUE

Wall units that mount this type of mechanism require little clearance above the cabinet thanks to the swivelling movement of the door that can be easily opened by applying slight pressure, even with heavy fronts. The doors stop in any position thanks to the gradual stopping movement; in this way, the handle is always easily accessible. The closing movement is cushioned and the closing force can be adjusted according to the weight of the front door.

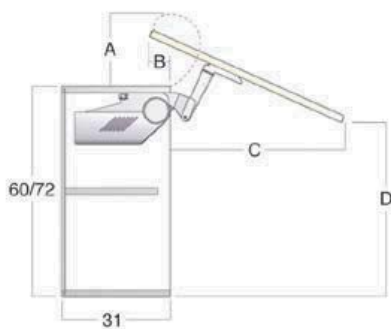





	A	B	C	D
H 60	18	9,6	46,5	53,5
H 72	18	9,6	57	61

PENSILI APERTURA VERTICALE OBLIQUA CHIUSURA BLUMOTION

P 33,2

WALL UNITS VERTICAL OBLIQUE OPENING AND BLUMOTION CLOSING SYSTEM

	COD.	MELAMINICO	POLIMERICO		LACCATO			GLAKS	
		K26	OPACO K27	LUCIDO K27	A K28	B K28	PELTRO K28	K30	
anta apertura verticale obliqua H 60 door with oblique vertical opening H 60 									
	L 60	E2135600	281	300	310	303	324	353	365
	L 90	E2135900	308	339	352	351	382	425	435
anta vetro apertura verticale obliqua H 60 glass door with oblique vertical opening H 60 									
	telaio petro-polimerico L 60 pewter-polymeric frame	E1205600	424	371	378	424	424	424	—
	L 90	E1205900	561	421	436	561	561	561	—
	telaio alluminio 419S L 60 aluminium frame	E1207600	434	434	434	434	434	434	—
	L 90	E1207900	493	493	493	493	493	493	—
anta apertura verticale obliqua H 72 door with oblique vertical opening H 72 									
	L 60	E2130600	292	316	327	320	344	382	392
	L 65	E2130650	307	331	343	341	367	403	427
	L 90	E2130900	319	353	369	369	404	459	467
anta vetro apertura verticale obliqua H 72 glass door with oblique vertical opening H 72 									
	telaio petro-polimerico L 60 pewter-polymeric frame	E1200600	473	386	398	473	473	473	—
	L 90	E1200900	620	443	461	620	620	620	—
	telaio alluminio 419S L 60 aluminium frame	E1202600	455	455	455	455	455	455	—
	L 90	E1202900	515	515	515	515	515	515	—

PENSILE CON APERTURA ANTE A PACCHETTO

Il meccanismo d'apertura ante a pacchetto è idoneo sia sul pensile H 72 che H 96; la regolazione della forza di apertura può essere impostata in modo esatto in base ai pesi dei frontali, la chiusura è ammortizzata e la cerniera centrale clip si contraddistingue per l'innovativa tecnologia che garantisce la sicurezza per le dita.

WALL UNIT WITH LIFT-UP FOLDING DOORS

The lift-up folding door opening mechanism is suitable for wall units with H 72 or H 96; the opening force can be adjusted precisely according to the weight of the fronts, while the closing movement is cushioned and the central clip-on hinge features innovative technology for safeguarding the fingers.



H 72



H 96

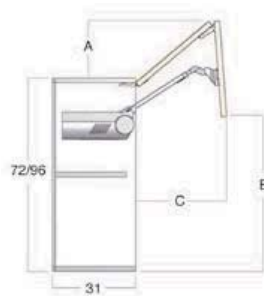

	A	B	C
H 72	16,5	54	41
H 96	20	69	53

SCHEMA MONTAGGIO LIMITATORE LIMITER INSTALLATION DIAGRAM

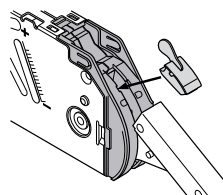





Per evitare l'interferenza dell'anta in fase di apertura con cornici o mensole, si può richiedere il limitatore dell'angolo di apertura cod. 5620005 € 10

In order to avoid that the door interferes with cornices or shelves during the opening movement, it is possible to request an opening angle limiter: code 5620005 € 10

PENSILI APERTURA A PACCHETTO

WALL UNITS FOLDING DOORS





P 33,2

	COD.	MELA-MINICO	POLIMERICO		LACCATO			GLAKS	
		K26	OPACO K27	LUCIDO K27	A K28	B K28	PELTRO K28	K30	
 <p>pensile H 72 apertura a pacchetto 2 ante H 36 wall unit H 72 lift-up folding door 2 doors H 36</p>	L 45	E2070450	286	300	310	299	318	343	390
	L 60	E2070600	302	318	330	322	346	381	417
	L 65	E2070650	315	336	349	338	364	402	457
	L 90	E2070900	337	360	378	373	409	462	495
 <p>pensile H 72 apertura a pacchetto 2 ante vetro H 36 wall unit H 72 lift-up folding door 2 glass doors H 36</p>									
	telaio peltro-polimerico L 45 pewter-polymeric frame	E1070450	447	426	433	447	447	447	—
	L 60	E1070600	516	441	451	516	516	516	—
	L 90	E1070900	628	490	504	627	627	627	—
	telaio alluminio 419S L 45 aluminium frame	E1075450	481	481	481	481	481	481	—
	L 60	E1075600	513	513	513	513	513	513	—
L 90	E1075900	589	589	589	589	589	589	—	
 <p>pensile H 72 apertura a pacchetto 1 anta chiusa superiore H 36 1 anta vetro inferiore H 36 wall unit H 72 lift-up folding door 1 full upper door H 36 1 glass lower door H 36</p>									
	telaio peltro-polimerico L 45 pewter-polymeric frame	E2075450	367	363	372	373	382	395	—
	L 60	E2075600	409	379	390	419	431	448	—
	L 90	E2075900	482	425	441	500	518	545	—
	telaio alluminio 419S L 45 aluminium frame	E2085450	374	378	383	380	389	402	—
	L 60	E2085600	398	404	410	408	420	437	—
	L 90	E2085900	452	461	470	469	487	514	—
 <p>pensile H 72 apertura a pacchetto 1 anta vetro superiore H 36 1 anta chiusa inferiore H 36 wall unit H 72 lift-up folding door 1 glass upper door H 36 1 full lower door H 36</p>									
	telaio peltro-polimerico L 45 pewter-polymeric frame	E2077450	367	363	372	373	382	395	—
	L 60	E2077600	409	379	390	419	431	448	—
	L 90	E2077900	482	425	441	500	518	545	—
	telaio alluminio 419S L 45 aluminium frame	E2087450	374	378	383	380	389	402	—
	L 60	E2087600	398	404	410	408	420	437	—
	L 90	E2087900	452	461	470	469	487	514	—

PENSILI APERTURA A PACCHETTO

P 33,2

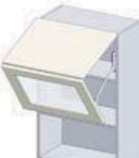
WALL UNITS FOLDING DOORS



	COD.	MELAMINICO	POLIMERICO		LACCATO			GLAKS	
		K26	OPACO K27	LUCIDO K27	A K28	B K28	PELTRO K28	K30	
 <p>pensile H 96 apertura a pacchetto 2 ante H 48 wall unit H 96 lift-up folding door 2 doors H 48</p>	L 45	E2090450	323	341	353	342	366	401	453
	L 60	E2090600	340	365	380	371	402	451	492
	L 65	E2090650	357	381	398	391	426	477	542
	L 90	E2090900	383	419	441	439	487	559	596
 <p>pensile H 96 apertura a pacchetto 2 ante vetro H 48 wall unit H 96 lift-up folding door 2 glass doors H 48</p>	telaio peltro-polimerico L 60 pewter-polymeric frame	E1090600	599	500	507	599	599	599	—
	L 90	E1090900	740	571	596	740	740	740	—
	telaio alluminio 419S L 60 aluminium frame	E1095600	574	574	574	574	574	574	—
	L 90	E1095900	663	663	663	663	663	663	—
 <p>pensile H 96 apertura a pacchetto 1 anta chiusa superiore H 48 1 anta vetro inferiore H 48 wall unit H 96 lift-up folding door 1 full upper door H 48 1 glass lower door H 48</p>	telaio peltro-polimerico L 60 pewter-polymeric frame	E2092600	470	430	438	485	501	525	—
	L 90	E2092900	561	492	516	590	614	649	—
	telaio alluminio 419S L 60 aluminium frame	E2097600	448	457	464	463	479	503	—
	L 90	E2097900	511	526	537	539	563	599	—
 <p>pensile H 96 apertura a pacchetto 1 anta vetro superiore H 48 1 anta chiusa inferiore H 48 wall unit H 96 lift-up folding door 1 glass upper door H 48 1 full lower door H 48</p>	telaio peltro-polimerico L 60 pewter-polymeric frame	E2096600	470	430	438	485	501	525	—
	L 90	E2096900	561	492	516	590	614	649	—
	telaio alluminio 419S L 60 aluminium frame	E2098600	448	457	464	463	479	503	—
	L 90	E2098900	511	526	537	539	563	599	—

PENSILI PER MICRO

P 33,2

WALL UNITS FOR MICROWAVE OVENS

N.B.: cerniere ammortizzate di serie
Note: standard blumotion hinges

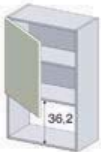
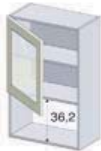





	COD.	MELAMINICO	POLIMERICO		LACCATO			GLAKS	
		K26	OPACO K27	LUCIDO K27	A K28	B K28	PELTRO K28	K30	
<p>pensile H 72 1 anta ribalta H 36 vano per micro Whirlpool wall unit H 72 1 flap door H 36 housing for Whirlpool microwave</p> 									
	L 60 EPM20600	144	150	156	154	166	183	202	
<p>pensile H 72 1 anta vetro ribalta H 36 vano per micro Whirlpool wall unit H 72 1 glass flap door H 36 housing for Whirlpool microwave</p> 									
	telaio peltro-polimerico L 60 pewter-polymeric frame	EPM10600	247	201	207	247	247	247	—
	telaio alluminio 419S L 60 aluminium frame	EPM11600	200	200	200	200	200	200	—
<p>pensile H 96 1 anta H 60 vano per micro Whirlpool wall unit H 96 1 door H 60 housing for Whirlpool microwave</p> 									
	L 60 EPM25601/2	155	167	177	178	198	227	240	
<p>pensile H 96 1 anta vetro H 60 vano per micro Whirlpool wall unit H 96 1 glass door H 60 housing for Whirlpool microwave</p> 									
	telaio peltro-polimerico L 60 pewter-polymeric frame	EPM15601/2	303	245	250	303	303	303	—
	telaio alluminio 419S L 60 aluminium frame	EPM16601/2	281	281	281	281	281	281	—

SOPRAPENSILI

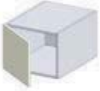
TOP UNITS

P 59,7







N.B.: cerniere ammortizzate di serie
Note: standard blumotion hinges

	COD.	MELA-MINICO	POLIMERICO		LACCATO			GLAKS	
		K26	OPACO K27	LUCIDO K27	A K28	B K28	PELTRO K28	K30	
 <p>soprapensile H 36 1 ante top unit H 36 1 door</p>									
	L 45	E2063451/2	127	132	137	134	143	155	179
	L 60	E2063601/2	155	161	167	165	177	194	213
 <p>soprapensile H 48 1 ante top unit H 48 1 door</p>									
	L 45	E2064451/2	163	169	175	173	185	202	228
	L 60	E2064601/2	193	203	210	209	225	249	270
 <p>soprapensile H 60 1 ante top unit H 60 1 door</p>									
	L 45	E2065451/2	164	173	181	179	194	216	236
	L 60	E2065601/2	197	209	219	220	240	269	282
 <p>soprapensile H 36 2 ante top unit H 36 2 doors</p>									
	L 90	E2063900	175	184	194	188	206	231	278
 <p>soprapensile H 48 2 ante top unit H 48 2 doors</p>									
	L 90	E2064900	239	250	262	257	281	316	369
 <p>soprapensile H 60 2 ante top unit H 60 2 doors</p>									
	L 90	E2065900	241	260	275	271	301	346	386

SCOLAPIATTI GRIGLIE INOX

PLATE RACK UNITS INOX GRILLES

P 33,2

gli scolapiatti sono realizzabili anche con apertura senza maniglia con presa sul fondo (opz.997) plate-rack units are feasible also without handle, grip on bottom opening (opt. 997)		COD.	MELAMINICO	POLIMERICO		LACCATO			GLAKS	
			K26	OPACO K27	LUCIDO K27	A K28	B K28	PELTRO K28	K30	
 <p>1 anta H 60 1 door H 60</p>	L 45	E3060451/2	124	134	142	140	155	177	197	
	L 60	E3060601/2	137	149	158	159	179	208	221	
				+84	+84	+84	+84	+84	+84	+84
 <p>1 anta H 72 1 door H 72</p>	L 45	E3010451/2	130	141	150	149	166	194	214	
	L 60	E3010601/2	141	158	169	170	193	231	241	
				+84	+84	+84	+84	+84	+84	+84
 <p>1 anta H 96 1 door H 96</p>	L 45	E3020451/2	152	167	178	179	202	240	257	
	L 60	E3020601/2	175	197	211	215	247	297	306	
				+84	+84	+84	+84	+84	+84	+84
 <p>1 anta H 120 - 132 1 door H 120 - 132</p>	H 120 L 60	E3067601/2	220	251	267	279	320	376	381	
	H 132 L 45	E3068451/2	219	241	257	265	299	344	369	
	H 132 L 60	E3068601/2	239	272	291	299	343	411	424	
				+84	+84	+84	+84	+84	+84	+84
 <p>1 anta vetro H 60 1 glass door H 60</p>	telaio peltro-polimerico L 60 pewter-polymeric frame	E3260601/2	278	221	226	278	278	278	—	
	telaio alluminio 419S L 60 aluminium frame	E3262601/2	242	242	242	242	242	242	—	
				+84	+84	+84	+84	+84	+84	—
 <p>1 anta vetro H 72 1 glass door H 72</p>	telaio peltro-polimerico L 45 pewter-polymeric frame	E3210451/2	270	201	214	270	270	270	—	
	L 60	E3210601/2	323	232	248	323	323	323	—	
	telaio alluminio 419S L 45 aluminium frame	E3212451/2	234	234	234	234	234	234	—	
	L 60	E3212601/2	258	258	258	258	258	258	—	
				+84	+84	+84	+84	+84	+84	—
 <p>1 anta vetro H 96 1 glass door H 96</p>	telaio peltro-polimerico L 45 pewter-polymeric frame	E3220451/2	336	238	254	336	336	336	—	
	telaio alluminio 419S L 45 aluminium frame	E3222451/2	273	273	273	273	273	273	—	
	L 60	E3222601/2	311	311	311	311	311	311	—	
				+84	+84	+84	+84	+84	+84	—

SCOLAPIATTI GRIGLIE INOX

PLATE RACK UNITS INOX GRILLES





P 33,2

gli scolapiatti sono realizzabili anche con apertura senza maniglia con presa sul fondo (opz.997) plate-rack units are feasible also without handle, grip on bottom opening (opt. 997)		COD.	MELAMINICO	POLIMERICO		LACCATO			GLAKS
			K26	OPACO K27	LUCIDO K27	A K28	B K28	PELTRO K28	K30
 <p>2 ante H 60 2 doors H 60</p>	<p>L 90</p> <p>mag.griglie con luce led surcharge grilles with led light</p>	E3060900	197	216	231	228	257	303	342
			+84	+84	+84	+84	+84	+84	+84
 <p>2 ante H 72 2 doors H 72</p>	<p>L 60</p> <p>L 80</p> <p>L 90</p> <p>mag.griglie con luce led surcharge grilles with led light</p>	E3010600	179	191	204	198	223	257	302
		E3010800	202	220	235	233	264	312	354
		E3010900	211	233	250	248	284	339	378
			+84	+84	+84	+84	+84	+84	+84
 <p>2 ante H 96 2 doors H 96</p>	<p>L 60</p> <p>L 80</p> <p>L 90</p> <p>mag.griglie con luce led surcharge grilles with led light</p>	E3020600	207	223	239	236	268	315	349
		E3020800	233	258	279	282	325	386	422
		E3020900	246	275	298	300	347	421	457
			+84	+84	+84	+84	+84	+84	+84
 <p>2 ante vetro H 72 2 glass doors H 72</p>	<p>telaio peltro-polimerico L 90 pewter-polymeric frame</p> <p>telaio alluminio 419S L 90 aluminium frame</p> <p>mag.griglie con luce led surcharge grilles with led light</p>	E3210900	492	352	379	492	492	492	—
		E3212900	417	417	417	417	417	417	—
			+84	+84	+84	+84	+84	+84	—
 <p>2 ante vetro H 96 2 glass doors H 96</p>	<p>telaio peltro-polimerico L 90 pewter-polymeric frame</p> <p>telaio alluminio 419S L 90 aluminium frame</p> <p>mag.griglie con luce led surcharge grilles with led light</p>	E3220900	613	418	450	613	613	613	—
		E3222900	486	486	486	486	486	486	—
			+84	+84	+84	+84	+84	+84	—
 <p>angolo H 72 2 ante a libretto N.B.: non si effettuano fuori squadra corner unit H 72 2 folding doors Note: out-of-plumb units unavailable</p>	<p>65X65</p>	E3450651/2	338	348	361	357	383	420	459
 <p>angolo H 96 2 ante a libretto N.B.: non si effettuano fuori squadra corner unit H 96 2 folding doors Note: out-of-plumb units unavailable</p>	<p>65X65</p>	E3460651/2	393	411	428	427	461	510	540

SCOLAPIATTI RIBALTA CHIUSURA AMMORTIZZATA GRIGLIE INOX

P 33,2





FLAP-DOOR PLATE RACK UNITS BLUMOTION CLOSING SYSTEM AND INOX GRILLES

	COD.	MELAMINICO	POLIMERICO		LACCATO			GLAKS	
		K26	OPACO K27	LUCIDO K27	A K28	B K28	PELTRO K28	K30	
anta ribalta H 36 flap door H 36 	L 60	E3100600	128	136	142	138	150	167	186
	L 90	E3100900	164	177	186	182	200	227	243
			+84	+84	+84	+84	+84	+84	+84
anta ribalta H 48 flap door H 48 	L 60	E3120600	160	169	177	175	191	215	236
	L 90	E3120900	186	201	212	214	238	274	293
			+84	+84	+84	+84	+84	+84	+84
anta vetro ribalta H 36 glass flap door H 36 	telaio petro-polimerico L 60 pewter-polymeric frame	E3130600	236	197	202	236	236	236	—
	L 90	E3130900	310	241	248	310	310	310	—
	telaio alluminio 419S L 60 aluminium frame	E3132600	214	214	214	214	214	214	—
	L 90	E3132900	271	271	271	271	271	271	—
			+84	+84	+84	+84	+84	+84	—
anta vetro ribalta H 48 glass flap door H 48 	telaio petro-polimerico L 60 pewter-polymeric frame	E3140600	291	234	242	291	291	291	—
	L 90	E3140900	366	282	294	366	366	366	—
	telaio alluminio 419S L 60 aluminium frame	E3142600	258	258	258	258	258	258	—
	L 90	E3142900	305	305	305	305	305	305	—
			+84	+84	+84	+84	+84	+84	—

SCOLAPIATTI RIBALTA CHIUSURA AMMORTIZZATA GRIGLIE INOX

P 33,2





FLAP-DOOR PLATE RACK UNITS BLUMOTION CLOSING SYSTEM AND INOX GRILLES

	COD.	MELAMINICO	POLIMERICO		LACCATO			GLAKS	
		K26	OPACO K27	LUCIDO K27	A K28	B K28	PELTRO K28	K30	
 <p>scolapiatti H 72 2 ante ribalta H 36 plate rack unit H 72 2 flap doors H 36</p>	L 60	EP313600	223	235	248	243	268	302	339
	L 90	EP313900	284	303	321	320	355	409	442
			+84	+84	+84	+84	+84	+84	+84
 <p>scolapiatti H 72 2 ante ribalta vetro H 36 plate rack unit H 72 2 glass flap doors H 36</p>	telaio peltro-polimerico L 60 pewter-polymeric frame	EP314600	440	356	359	440	440	440	—
	L 90	EP314900	577	432	451	577	577	577	—
	telaio alluminio 419S L 60 aluminium frame	EP315600	396	396	396	396	396	396	—
	L 90	EP315900	500	500	500	500	500	500	—
			+84	+84	+84	+84	+84	+84	—
 <p>scolapiatti H 72 1 anta chiusa ribalta superiore H 36 1 anta vetro ribalta inferiore H 36 plate rack unit H 72 1 full upper flap door H 36 1 glass lower flap door H 36</p>	telaio peltro-polimerico L 60 pewter-polymeric frame	EP316600	331	295	303	341	354	371	—
	L 90	EP316900	431	368	386	448	466	493	—
	telaio alluminio 419S L 60 aluminium frame	EP317600	309	315	322	319	332	349	—
	L 90	EP317900	392	401	410	410	427	454	—
			+84	+84	+84	+84	+84	+84	—
 <p>scolapiatti H 72 1 anta vetro ribalta superiore H 36 1 anta chiusa ribalta inferiore H 36 plate rack unit H 72 1 glass upper flap door H 36 1 full lower flap door H 36</p>	telaio peltro-polimerico L 60 pewter-polymeric frame	EP318600	331	295	303	341	354	371	—
	L 90	EP318900	431	368	386	448	466	493	—
	telaio alluminio 419S L 60 aluminium frame	EP319600	309	315	322	319	332	349	—
	L 90	EP319900	392	401	410	410	427	454	—
			+84	+84	+84	+84	+84	+84	—

SCOLAPIATTI RIBALTA CHIUSURA AMMORTIZZATA GRIGLIE INOX

P 33,2





FLAP-DOOR PLATE RACK UNITS BLUMOTION CLOSING SYSTEM AND INOX GRILLES

	COD.	MELA-	POLIMERICO		LACCATO			GLAKS	
		MINICO K26	OPACO K27	LUCIDO K27	A K28	B K28	PELTRO K28	K30	
 <p>scolapiatti H 96 2 ante ribalta H 48 plate rack unit H 96 2 flap doors H 48</p>	L 60	EP323600	271	293	305	302	334	383	424
	L 90	EP323900	317	350	369	373	421	493	530
			+84	+84	+84	+84	+84	+84	+84
 <p>scolapiatti H 96 2 ante ribalta vetro H 48 plate rack unit H 96 2 glass flap doors H 48</p>									
	telaio petro-polimerico L 60 pewter-polymeric frame	EP324600	540	429	444	540	540	540	—
	L 90	EP324900	684	515	540	684	684	684	—
	telaio alluminio 419S L 60 aluminium frame	EP325600	475	475	475	475	475	475	—
L 90	EP325900	562	562	562	562	562	562	—	
			+84	+84	+84	+84	+84	+84	—
 <p>scolapiatti H 96 1 anta chiusa ribalta superiore H 48 1 anta vetro ribalta inferiore H 48 plate rack unit H 96 1 full upper flap door H 48 1 glass lower flap door H 48</p>									
	telaio petro-polimerico L 60 pewter-polymeric frame	EP326600	403	358	371	418	434	458	—
	L 90	EP326900	497	428	451	525	549	585	—
	telaio alluminio 419S L 60 aluminium frame	EP327600	370	379	387	385	401	425	—
L 90	EP327900	436	451	462	464	488	524	—	
			+84	+84	+84	+84	+84	+84	—
 <p>scolapiatti H 96 1 anta vetro ribalta superiore H 48 1 anta chiusa ribalta inferiore H 48 plate rack unit H 96 1 glass upper flap door H 48 1 full lower flap door H 48</p>									
	telaio petro-polimerico L 60 pewter-polymeric frame	EP328600	403	358	371	418	434	458	—
	L 90	EP328900	497	428	451	525	549	585	—
	telaio alluminio 419S L 60 aluminium frame	EP329600	370	379	387	385	401	425	—
L 90	EP329900	436	451	462	464	488	524	—	
			+84	+84	+84	+84	+84	+84	—

SCOLAPIATTI APERTURA VERTICALE OBLIQUA CHIUSURA BLUMOTION

P 33,2





PLATE RACK UNITS VERTICAL OBLIQUE OPENING AND BLUMOTION CLOSING SYSTEM

	COD.	MELA-MINICO	POLIMERICO		LACCATO			GLAKS	
		K26	OPACO K27	LUCIDO K27	A K28	B K28	PELTRO K28	K30	
 <p>anta apertura verticale obliqua H 60 griglie inox e raccogliocce inox door with vertical oblique opening H 60 inox grilles and stainless steel drip tray</p>									
	L 60	E3123600	303	317	326	326	346	375	388
	L 90	E3123900	340	364	377	384	414	457	468
			+84	+84	+84	+84	+84	+84	+84
<i>mag.griglie con luce led surcharge grilles with led light</i>									
 <p>anta vetro apertura verticale obliqua H 60 griglie inox e raccogliocce inox glass door with vertical oblique opening H 60 inox grilles and stainless steel drip tray</p>									
	telaio peltro-polimerico L 60 pewter-polymeric frame	E3205600	445	385	393	445	445	445	—
	L 90	E3205900	593	454	469	593	593	593	—
	telaio alluminio 419S L 60 aluminium frame	E3207600	442	442	442	442	442	442	—
	L 90	E3207900	514	514	514	514	514	514	—
		+84	+84	+84	+84	+84	+84	—	
<i>mag.griglie con luce led surcharge grilles with led light</i>									
 <p>anta apertura verticale obliqua H 72 griglie inox e raccogliocce inox door with vertical oblique opening H 72 inox grilles and stainless steel drip tray</p>									
	L 60	E3125600	313	330	341	341	364	402	412
	L 90	E3125900	349	376	392	399	434	489	497
			+84	+84	+84	+84	+84	+84	+84
<i>mag.griglie con luce led surcharge grilles with led light</i>									
 <p>anta vetro apertura verticale obliqua H 72 griglie inox e raccogliocce inox glass door with vertical oblique opening H 72 inox grilles and stainless steel drip tray</p>									
	telaio peltro-polimerico L 60 pewter-polymeric frame	E3200600	494	407	419	494	494	494	—
	L 90	E3200900	652	474	493	652	652	652	—
	telaio alluminio 419S L 60 aluminium frame	E3202600	461	461	461	461	461	461	—
	L 90	E3202900	523	523	523	523	523	523	—
		+84	+84	+84	+84	+84	+84	—	
<i>mag.griglie con luce led surcharge grilles with led light</i>									

SCOLAPIATTI APERTURA A PACCHETTO CHIUSURA BLUMOTION

P 33,2





PLATE RACK UNITS LIFT-UP FOLDING DOORS AND BLUMOTION CLOSING SYSTEM

	COD.	MELAMINICO	POLIMERICO		LACCATO			GLAKS		
		K26	OPACO K27	LUCIDO K27	A K28	B K28	PELTRO K28	K30		
 <p>scolapiatti H 72 apertura a pacchetto 2 ante H 36 griglie inox plate rack unit H 72 lift-up folding door 2 doors H 36 inox grilles</p>	L 45	E3081450	303	316	325	316	334	359	406	
	L 60	E3081600	316	331	343	336	361	395	432	
	L 90	E3081900	355	377	394	391	427	480	513	
				+84	+84	+84	+84	+84	+84	+84
 <p>scolapiatti H 72 apertura a pacchetto 2 ante vetro H 36 griglie inox plate rack unit H 72 lift-up folding door 2 glass doors H 36 inox grilles</p>	telaio petro-polimerico L 45 pewter-polymeric frame	E3270450	463	441	449	463	463	463	—	
	L 60	E3270600	530	454	464	530	530	530	—	
	L 90	E3270900	645	506	521	645	645	645	—	
	telaio alluminio 419S L 45 aluminium frame	E3275450	501	501	501	501	501	501	—	
	L 60	E3275600	530	530	530	530	530	530	—	
	L 90	E3275900	605	605	605	605	605	605	—	
				+84	+84	+84	+84	+84	+84	—
 <p>scolapiatti H 72 apertura a pacchetto 1 anta chiusa superiore H 36 1 anta vetro inferiore H 36 griglie inox plate rack unit H 72 lift-up folding door 1 full upper door H 36 1 glass lower door H 36 inox grilles</p>	telaio petro-polimerico L 45 pewter-polymeric frame	E3085450	383	379	387	389	399	411	—	
	L 60	E3085600	423	392	403	433	445	462	—	
	L 90	E3085900	500	442	457	518	536	563	—	
	telaio alluminio 419S L 45 aluminium frame	E3075450	394	398	403	400	409	422	—	
	L 60	E3075600	416	422	429	426	439	456	—	
	L 90	E3075900	470	479	488	487	505	532	—	
				+84	+84	+84	+84	+84	+84	—
 <p>scolapiatti H 72 apertura a pacchetto 1 anta vetro superiore H 36 1 anta chiusa inferiore H 36 griglie inox plate rack unit H 72 lift-up folding door 1 glass upper door H 36 1 full lower door H 36 inox grilles</p>	telaio petro-polimerico L 45 pewter-polymeric frame	E3087450	383	379	387	389	399	411	—	
	L 60	E3087600	423	392	403	433	445	462	—	
	L 90	E3087900	500	442	457	518	536	563	—	
	telaio alluminio 419S L 45 aluminium frame	E3077450	394	398	403	400	409	422	—	
	L 60	E3077600	416	422	429	426	439	456	—	
	L 90	E3077900	470	479	488	487	505	532	—	
				+84	+84	+84	+84	+84	+84	—

SCOLAPIATTI APERTURA VERTICALE OBLIQUA CHIUSURA BLUMOTION

P 33,2

PLATE RACK UNITS VERTICAL OBLIQUE OPENING AND BLUMOTION CLOSING SYSTEM

	COD.	MELA-MINICO	POLIMERICO		LACCATO			GLAKS		
		K26	OPACO K27	LUCIDO K27	A K28	B K28	PELTRO K28	K30		
 <p>scolapiatti H 96 apertura a pacchetto 2 ante H 48 griglie inox plate rack unit H 96 lift-up folding door 2 doors H 48 inox grilles</p>	L 45	E3094450	340	357	369	358	382	417	469	
	L 60	E3094600	354	377	393	385	417	465	507	
	L 90	E3094900	401	436	458	457	505	577	614	
				mag.griglie con luce led						
				+84	+84	+84	+84	+84	+84	+84
 <p>scolapiatti H 96 apertura a pacchetto 2 ante vetro H 48 griglie inox plate rack unit H 96 lift-up folding door 2 glass doors H 48 inox grilles</p>										
	telaio petro-polimerico L 60 pewter-polymeric frame	E3290600	614	507	520	614	614	614	—	
	L 90	E3290900	758	589	614	758	758	758	—	
	telaio alluminio 419S L 60 aluminium frame	E3295600	587	587	587	587	587	587	—	
	L 90	E3295900	680	680	680	680	680	680	—	
			mag.griglie con luce led							
			+84	+84	+84	+84	+84	+84	+84	
 <p>scolapiatti H 96 apertura a pacchetto 1 anta chiusa superiore H 48 1 anta vetro inferiore H 48 griglie inox plate rack unit H 96 lift-up folding door 1 full upper door H 48 1 glass lower door H 48 inox grilles</p>										
	telaio petro-polimerico L 60 pewter-polymeric frame	E3095600	488	446	460	503	519	543	—	
	L 90	E3095900	579	510	534	608	631	667	—	
	telaio alluminio 419S L 60 aluminium frame	E3098600	468	477	485	484	499	524	—	
	L 90	E3098900	535	550	562	563	587	623	—	
			mag.griglie con luce led							
			+84	+84	+84	+84	+84	+84	+84	
 <p>scolapiatti H 96 apertura a pacchetto 1 anta vetro superiore H 48 1 anta chiusa inferiore H 48 griglie inox plate rack unit H 96 lift-up folding door 1 glass upper door H 48 1 full lower door H 48 inox grilles</p>										
	telaio petro-polimerico L 60 pewter-polymeric frame	E3097600	488	446	460	503	519	543	—	
	L 90	E3097900	579	510	534	608	631	667	—	
	telaio alluminio 419S L 60 aluminium frame	E3099600	468	477	485	484	499	524	—	
	L 90	E3099900	535	550	562	563	587	623	—	
			mag.griglie con luce led							
			+84	+84	+84	+84	+84	+84	+84	





CAPPE ASPIRANTI

EXTRACTOR HOODS

P 33,2

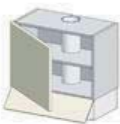
N.B.: cerniere ammortizzate di serie



Note: standard blumotion hinges

	COD.	MELAMINICO	POLIMERICO		LACCATO			GLAKS	
		K26	OPACO K27	LUCIDO K27	A K28	B K28	PELTRO K28	K30	
 <p>cappa estraibile 1 motore portata 160 m³/h con laterali in metallo, 1 anta N.B. : posizionare la cappa ad una distanza non inferiore ai 65 cm dal piano cottura</p> <p>slide-out hood 1 motor air flow rate 160 m³/h with metal sides, 1 door Note: position the hood at least 65 cm from the cooker hob</p>	H 63 L 60	E3600601/2	194	207	219	212	235	276	309
	H 87 L 60	E3610601/2	211	231	246	241	272	326	349
	n° 1 filtro carbone attivo 1 active carbon filter		+12	+12	+12	+12	+12	+12	+12
	maggiorazione 2 motori portata 235 m³/h surcharge 2 motors air flow rate 235 m³/h		+30	+30	+30	+30	+30	+30	+30
	n° 2 filtri carbone attivo 2 active carbon filters		+24	+24	+24	+24	+24	+24	+24
 <p>cappa estraibile 1 motore portata 160 m³/h con laterali in metallo, 2 ante N.B. : posizionare la cappa ad una distanza non inferiore ai 65 cm dal piano cottura</p> <p>slide-out hood 1 motor air flow rate 160 m³/h with metal sides, 2 doors Note: position the hood at least 65 cm from the cooker hob</p>	H 63 L 90	E3600900	254	270	289	279	314	356	439
	H 87 L 90	E3610900	276	303	325	320	366	428	494
	n° 1 filtro carbone attivo 1 active carbon filter		+12	+12	+12	+12	+12	+12	+12
	maggiorazione 2 motori portata 235 m³/h surcharge 2 motors air flow rate 235 m³/h		+30	+30	+30	+30	+30	+30	+30
	n° 2 filtri carbone attivo 2 active carbon filters		+24	+24	+24	+24	+24	+24	+24
 <p>cappa "Mod. F" integrata totale con frontalino vetro estraibile portata 415 m³/h con faretti a led 1 anta N.B.: posizionare la cappa ad una distanza non inferiore ai 55 cm dal piano cottura N.B.: realizzabile anche con apertura senza maniglia presa sul fondo (opz.997)</p> <p>"Mod. F" fully integrated hood with glass pull-out frontal panel air flow rate 415 m³/h, with led lights 1 door Note: position the hood at least 55 cm from the cooker hob Note: feasible even with grip on bottom opening (opz.997)</p>	H 60 L 60	EPC90461/2	458	470	479	480	501	529	542
	H 72 L 60	EPC90561/2	462	478	489	490	515	551	562
	H 96 L 60	EPC90661/2	491	511	526	530	561	611	620
	n° 2 filtri carbone attivo 2 active carbon filters	08750894	+28	+28	+28	+28	+28	+28	+28
	 <p>cappa "Mod. F" integrata totale con frontalino vetro estraibile portata 415 m³/h con faretti a led 2 ante N.B. : posizionare la cappa ad una distanza non inferiore ai 55 cm dal piano cottura N.B.: realizzabile anche con apertura senza maniglia presa sul fondo (opz.997)</p> <p>"Mod. F" fully integrated hood with glass pull-out front panel air flow rate 415 m³/h with led lights 2 doors Note: position the hood at least 55 cm from the cooker hob Note: feasible even with grip on bottom opening (opz.997)</p>	H 60 L 90	EPC90490	532	552	567	563	593	638
H 72 L 90		EPC90590	544	565	583	581	616	671	710
H 96 L 90		EPC90690	578	607	629	631	678	752	788
n° 2 filtri carbone attivo 2 active carbon filters		08750894	+28	+28	+28	+28	+28	+28	+28

CAPPE ASPIRANTI

EXTRACTOR HOODS

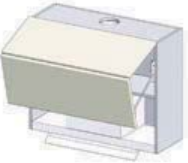
P 33,2



	COD.	MELAMINICO	POLIMERICO		LACCATO			GLAKS	
		K26	OPACO K27	LUCIDO K27	A K28	B K28	PELTRO K28	K30	
<p>N.B.: cerniere ammortizzate di serie Note: standard blumotion hinges</p> <p>cappa "Mod. F" integrata totale con frontalino vetro estraibile portata 415 m³/h con faretti a led 1 anta apertura a ribalta N.B. : posizionare la cappa ad una distanza non inferiore ai 55 cm dal piano cottura N.B.: realizzabile anche con apertura senza maniglia presa sul fondo (opz.997)</p>  <p>"Mod. F" fully integrated hood with glass pull-out front panel air flow rate 415 m³/h with led lights 1 flap door Note: position the hood at least 55 cm from the cooker hob Note: feasible even with grip on bottom opening (opz.997)</p>	H 36 L 60	EPC80260	439	445	452	449	461	479	497
	H 36 L 90	EPC80290	495	504	513	512	530	557	573
	H 48 L 60	EPC80360	479	488	496	495	511	535	556
	H 48 L 90	EPC80390	525	539	551	553	577	612	631
	n° 2 filtri carbone attivo 2 active carbon filters	08750894	+28	+28	+28	+28	+28	+28	+28
<p>cappa "Mod. F" integrata totale con frontalino vetro estraibile portata 415 m³/h con faretti a led 2 ante apertura a pacchetto N.B. : posizionare la cappa ad una distanza non inferiore ai 55 cm dal piano cottura N.B.: realizzabile anche con apertura senza maniglia presa sul fondo (opz.997)</p>  <p>"Mod. F" fully integrated hood with glass pull-out front panel air flow rate 415 m³/h with led lights 2 lift-up folding doors Note: position the hood at least 55 cm from the cooker hob Note: feasible even with grip on bottom opening (opz.997)</p>	H 72 L 60	EPC83560	632	648	661	656	681	715	752
	H 72 L 90	EPC83590	692	716	733	732	768	821	854
	H 96 L 60	EPC83660	669	695	711	708	740	788	830
	H 96 L 90	EPC83690	737	774	797	801	849	921	958
	n° 2 filtri carbone attivo 2 active carbon filters	08750894	+28	+28	+28	+28	+28	+28	+28
<p>cappa "Mod.F" integrata totale con frontalino estraibile inox portata 450 m³/h 1 anta apertura verticale obliqua N.B. : posizionare la cappa ad una distanza non inferiore ai 55 cm dal piano cottura N.B.: realizzabile anche con apertura senza maniglia presa sul fondo (opz.997)</p>  <p>"Mod. F" fully-integrated hood with glass pull-out front panel flow rate 415 m³/h with led lights 1 door with vertical oblique opening Note: position the hood at least 55 cm from the cooker hob Note: feasible even with grip on bottom opening (opz.997)</p>	H 60 L 60	EPC86460	602	622	624	625	645	674	686
	H 60 L 90	EPC86490	678	711	715	721	752	794	805
	H 72 L 60	EPC86560	633	659	661	662	685	723	733
	H 72 L 90	EPC86590	687	723	730	736	772	827	835
	n° 2 filtri carbone attivo 2 active carbon filters	08750894	+28	+28	+28	+28	+28	+28	+28











BASI

BASE UNITS

H 87 P 61



Le basi non sono comprensive di top - N.B.: cerniere ammortizzate di serie The base units do not include the tops - Note: standard blumotion hinges	COD.	MELAMINICO	POLIMERICO		LACCATO			GLAKS	
		K26	OPACO K27	LUCIDO K27	A K28	B K28	PELTRO K28	K30	
fascia tamponamento filler panel 	L da 3 a 10 size 3 to 10	E4800000	56	65	71	85	105	112	125
jolly base colore come struttura L da 10 a 30 jolly base unit same colour as carcass size 10 to 30 	in nobilitato melamine coated	E4700000	75	75	75	75	75	75	75
1 anta 1 door 	L 15 L 30 L 40 L 45 L 60 L 65	E4010151/2	104	103	107	107	115	129	146
		E4010301/2	111	117	124	121	133	150	173
		E4010401/2	124	133	141	139	155	179	200
		E4010451/2	129	140	148	148	165	193	212
		E4010601/2	145	162	173	174	197	235	245
		E4010651/2	159	175	187	193	220	255	279
2 ante 2 doors 	L 60 L 80 L 90	E4010600	175	188	200	195	219	253	298
		E4010800	199	217	233	230	262	310	352
		E4010900	210	231	249	247	282	337	376
cestello estraibile chiusura soft pull-out basket drawer soft-closing system 	L 15 L 30 L 45	E4150150	145	144	148	148	156	170	187
		E4150300	180	188	193	190	202	220	242
		E4150450	200	212	220	218	236	264	283

Le basi non sono comprensive di top - N.B.: cassetti e cestoni ad estrazione totale con blumotion The base units do not include the tops - Note: fully extending drawers and deep drawers with blumotion system		COD.	MELAMINICO	POLIMERICO		LACCATO			GLAKS	
			K26	OPACO K27	LUCIDO K27	A K28	B K28	PELTRO K28	K30	
 <p>4 cassetti H 18 4 drawers H 18</p>	L 30	E4101300	298	300	308	323	348	429	431	
	L 40	E4101400	316	320	331	337	363	442	461	
	L 45	E4101450	331	334	346	347	374	451	480	
	L 60	E4101600	370	367	383	378	407	472	524	
 <p>2 cassetti H 18 1 cestone H 36 2 drawers H 18 1 deep drawer H 36</p>	L 45	E4131450	284	290	301	298	321	372	410	
	L 60	E4131600	316	321	335	330	357	407	451	
	L 90	E4131900	373	386	406	406	445	485	551	
 <p>2 cassetti H 18 1 cestone vetro H 36 2 drawers H 18 1 glass deep drawer H 36</p>										
		telaio peltro-polimerico L 45 pewter-polymeric frame	E4141450	364	343	354	372	385	424	—
	L 60	E4141600	423	375	389	427	442	474	—	
	L 90	E4141900	519	449	470	533	555	567	—	
		telaio alluminio 419S L 45 aluminium frame	E4143450	356	358	364	364	377	416	—
	L 60	E4143600	397	396	404	401	416	449	—	
L 90	E4143900	473	477	487	488	509	522	—		
 <p>portaposate in plastica per cassetti plastic cutlery tray for drawers</p>	L 30	08700030X	10	10	10	10	10	10	10	
	L 40	08700040X	10	10	10	10	10	10	10	
	L 45	08700050X	10	10	10	10	10	10	10	
	L 60	08700060X	11	11	11	11	11	11	11	
	L 90	divisori regolabili adjustable separators	08700070X	32	32	32	32	32	32	32
 <p>4 cassetti H 18 1 cestone H 36 4 drawers H 18 1 deep drawer H 36</p>	L 90	E4300900	482	494	515	515	559	664	709	

Le basi non sono comprensive di top - N.B.: cassetti e cestoni ad estrazione totale con blumotion The base units do not include the tops - Note: fully extending drawers and deep drawers with blumotion system	COD.	MELAMINICO	POLIMERICO		LACCATO			GLAKS	
		K26	OPACO K27	LUCIDO K27	A K28	B K28	PELTRO K28	K30	
4 cassetti H 18 1 cestone vetro H 36 4 drawers H 18 1 glass deep drawer H 36 									
	telaio peltro-polimerico L 90 pewter-polymeric frame telaio alluminio 419S L 90 aluminium frame	E4301900	627	531	578	642	669	746	—
2 cestoni H 36 2 deep drawers H 36 									
	L 45	E4171450	236	246	256	249	268	293	340
	L 60	E4171600	261	274	286	282	306	340	377
	L 90	E4171900	315	334	352	350	386	440	472
2 cestoni 1 frontale chiuso H 36 1 frontale vetro H 36 2 deep drawers 1 full front H 36 1 glass front H 36 									
	telaio peltro-polimerico L 45 pewter-polymeric frame	E4181450	316	299	308	323	332	344	—
	L 60	E4181600	368	327	340	378	390	407	—
	L 90	E4181900	457	394	413	475	493	520	—
	telaio alluminio 419S L 45 aluminium frame	E4183450	308	313	318	315	324	336	—
	L 60	E4183600	342	349	355	353	365	382	—
L 90	E4183900	412	421	430	429	447	474	—	
2 cestoni vetro H 36 2 glass deep drawers H 36 									
	telaio peltro-polimerico L 45 pewter-polymeric frame	E4191450	397	352	362	397	397	397	—
	L 60	E4191600	475	381	395	475	475	475	—
	L 90	E4191900	605	460	480	605	605	605	—
	telaio alluminio 419S L 45 aluminium frame	E4193450	410	410	410	410	410	410	—
	L 60	E4193600	456	456	456	456	456	456	—
L 90	E4193900	552	552	552	552	552	552	—	

Le basi non sono comprensive di top - N.B.: cassetti e cestoni ad estrazione totale con blumotion
 The base units do not include the tops - Note: fully extending drawers and deep drawers with blumotion system

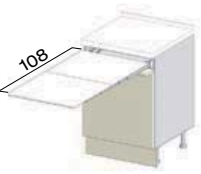
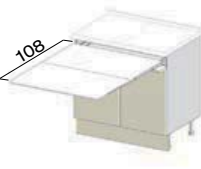
	COD.	MELAMINICO	POLIMERICO		LACCATO			GLAKS	
		K26	OPACO K27	LUCIDO K27	A K28	B K28	PELTRO K28	K30	
 <p>1 cassetto H 12 1 anta H 60 1 drawer H 12 1 door H 60</p>	L 45	E4021451/2	191	201	211	213	230	276	296
	L 60	E4021601/2	215	226	239	242	270	316	329
 <p>1 cassetto H 12 2 ante H 60 1 drawer H 12 2 doors H 60</p>	L 90	E4021900	284	302	322	320	358	415	471
	 <p>1 anta 2 cassetti interni 1 cestone interno posizionare a 5 cm dalla parete laterale 1 door 2 internal drawers 1 internal deep drawer place at 5 cm from the side wall</p>	L 45	E4236461/2	329	340	349	348	366	393
L 60		E4236611/2	362	378	389	390	414	451	462
 <p>1 anta 2 cestoni interni posizionare a 5 cm dalla parete laterale 1 door 2 internal deep drawers place at 5 cm from the side wall</p>	L 45	E4236471/2	280	291	300	299	316	344	363
	L 60	E4236621/2	309	325	336	337	360	398	408



Le basi non sono comprensive di top The base units do not include the tops	COD.	MELA-MINICO	POLIMERICO		LACCATO			GLAKS	
		K26	OPACO K27	LUCIDO K27	A K28	B K28	PELTRO K28	K30	
 <p>base tavolo estraibile LUNCH portata 60 kg 1 anta H 60 1 frontale H 12 base unit with pull-out table LUNCH load capacity kg 60 1 door H 60 1 front H 12</p>	L 60	E4230601/2	582	597	609	609	636	683	696
	 <p>base tavolo estraibile LUNCH portata 60 kg 2 ante H 60 1 frontale H 12 base unit with pull-out table LUNCH load capacity kg 60 2 doors H 60 1 front H 12</p>	L 90	E4230900	645	664	683	681	719	776
 <p>terminale a giorno tipo "A" colore come struttura open end unit type "A" same colour as carcass</p>		in nobilitato L 34,5 melamine coated	E4610311/2	112	112	112	112	112	112

BASI ANGOLO

CORNER BASE UNITS

H 87 P 65

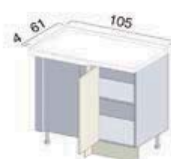
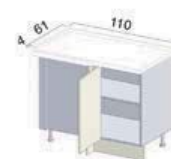
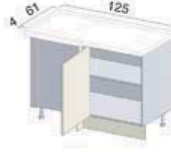

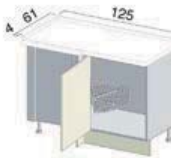

Le basi non sono comprensive di top - N.B.: cerniere ammortizzate di serie
 The base units do not include the tops - Note: standard blumotion hinges

	COD.	MELA-MINICO	POLIMERICO		LACCATO			GLAKS	
		K26	OPACO K27	LUCIDO K27	A K28	B K28	PELTRO K28	K30	
 <p>angolo L 95 1 ripiano 1 anta L 30 (cerniere a pilastro) cassone 90 corner unit W 95 1 shelf 1 door W 30 (pillar hinges) structure 90</p> <p>verso dx RH version</p>	95x65	E4400951/2	252	274	283	271	304	332	347
	 <p>angolo L 105 1 ripiano 1 anta L 40 (cerniere a pilastro) cassone 90 corner unit W 105 1 shelf 1 door W 40 (pillar hinges) structure 90</p> <p>verso dx RH version</p>	105x65	E4401041/2	258	282	294	283	320	354
 <p>angolo L 110 1 ripiano 1 anta L 45 (cerniere a pilastro) cassone 105 corner unit W 110 1 shelf 1 door W 45 (pillar hinges) structure 105</p> <p>verso dx RH version</p>		110x65	E4401091/2	278	305	317	307	345	383
	 <p>angolo L 125 1 ripiano 1 anta L 60 (cerniere a pilastro) cassone 120 corner unit W 125 1 shelf 1 door W 60 (pillar hinges) structure 120</p> <p>verso dx RH version</p>	125x65	E4401241/2	295	326	341	333	377	425
 <p>angolo L 110 cestello mezzaluna 1 anta L 45 (cerniere a pilastro) cassone 105 corner unit W 110 crescent-shaped wire basket drawer 1 door W 45 (pillar hinges) structure 105</p> <p>verso dx RH version</p>		1 cestello 110x65 1 basket drawer	E4401101/2	278	305	317	307	345	383
	2 cestelli 110x65 2 basket drawers	E4401111/2	305	331	343	333	372	409	422
 <p>angolo L 125 cestello mezzaluna 1 anta L 60 (cerniere a pilastro) cassone 120 corner unit W 125 crescent-shaped wire basket drawer 1 door W 60 (pillar hinges) structure 120</p> <p>verso dx RH version</p>	1 cestello 125x65 1 basket drawer	E4401251/2	295	326	341	333	377	425	428
	2 cestelli 125x65 2 basket drawers	E4401261/2	321	353	368	359	404	451	455

BASI ANGOLO

CORNER BASE UNITS

H 87 P 65







Le basi non sono comprensive di top - N.B.: cerniere ammortizzate di serie The base units do not include the tops - Note: standard blumotion hinges		COD.	MELA-MINICO	POLIMERICO		LACCATO			GLAKS
			K26	OPACO K27	LUCIDO K27	A K28	B K28	PELTRO K28	K30
 <p>angolo L 110 4 cestelli estraibili indipendenti dall'anta 1 anta L 45 (cerniere a pilastro) cassone 105 corner unit W 110 4 pull-out basket drawers opening independently from door 1 door W 45 (pillar hinges) structure 105</p> <p>verso dx RH version</p>	110x65	E4451101/2	788	815	827	817	882	893	906
 <p>angolo L 125 4 cestelli estraibili indipendenti dall'anta 1 anta L 60 (cerniere a pilastro) cassone 120 corner unit W 125 4 pull-out basket drawers opening independently from door 1 door W 60 (pillar hinges) structure 120</p> <p>verso dx RH version</p>	125x65	E4451251/2	855	886	901	893	964	985	988
 <p>angolo 95x95 1 ripiano 2 ante L 30 (cerniere 180°) corner unit 95x95 1 shelf 2 doors W 30 (180° hinges)</p>	95x95	E4480950	408	439	457	440	497	540	590
 <p>angolo 110x110 1 ripiano 2 ante L 45 (cerniere 180°) corner unit 110x110 1 shelf 2 doors W 45 (180° hinges)</p>	110x110	E4481100	466	507	530	518	587	653	696
 <p>angolo 95x95 ante girevoli N.B.: non è possibile inserire elettrodomestici corner unit 95x95 swivel doors Note: household appliances cannot be inserted</p>	95x95	E4470950	904	937	957	955	1.012	1.039	1.078

BASI PER FORNI

H 87 P 61

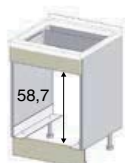
OVEN BASE UNITS



Le basi non sono comprensive di top - N.B.: cassette ad estrazione totale con blumotion
 The base units do not include the tops - Note: fully extending drawers with blumotion system

	COD.	MELA-MINICO	POLIMERICO		LACCATO			GLAKS	
		K26	OPACO K27	LUCIDO K27	A K28	B K28	PELTRO K28	K30	
 <p>base per forno elettrico H 60 frontale inferiore fisso H 12 electric oven base unit H 60 fixed lower front H 12</p>	L 60	E5510610	126	126	129	131	138	156	156
	 <p>base per forno elettrico H 60 cassetto H 12 inferiore electric oven base unit H 60 lower drawer H 12</p>	L 60	E5510607	184	184	187	189	197	215
 <p>base per forno elettrico H 60 cassetto H 12 superiore electric oven base unit H 60 upper drawer H 12</p>		L 60	E5510608	184	184	187	189	197	215
	 <p>base per forno elettrico H 48 cassetto H 18 electric oven base unit H 48 drawer H 18</p>	L 60	E5530600	212	200	205	211	226	263
 <p>base per maxiforno H 60 cassetto H 12 maxi-oven base unit H 60 drawer H 12</p>		L 90	E5510907	218	217	221	223	232	244
	 <p>base per maxiforno H 48 cassetto H 18 maxi-oven base unit H 48 drawer H 18</p>	L 90	E5510920	245	235	244	251	270	291

BASI PER FORNI

H 87 P 61





OVEN BASE UNITS

Le basi non sono comprensive di top - N.B.: cassetti ad estrazione totale con blumotion The base units do not include the tops - Note: fully extending drawers with blumotion system	COD.	MELA-MINICO	POLIMERICO		LACCATO			GLAKS	
		K26	OPACO K27	LUCIDO K27	A K28	B K28	PELTRO K28	K30	
 <p>kit raccordo base angolo junction kit for corner base unit</p>									
	110x110	E5471100	125	110	115	122	137	167	171
 <p>kit raccordo base angolo per inserimento lavastoviglie a destra o sinistra junction kit for corner base unit for dishwasher placed on the right or the left side</p>									
	<p>verso dx RH version</p>	110x110	E5471151/2	161	146	151	157	173	203

BASI PER PIANI COTTURA

H 87 P 61





COOKER HOB BASE UNITS

Le basi non sono comprensive di top The base units do not include the tops	COD.	MELA- MINICO	POLIMERICO		LACCATO			GLAKS	
		K26	OPACO K27	LUCIDO K27	A K28	B K28	PELTRO K28	K30	
 <p>base predisposta piano cottura 1 anta base unit configured for cooker hob 1 door</p>	L 60	E5500601/2	150	167	178	179	197	240	250
	L 90	E5500900	215	237	255	253	282	343	382
 <p>base predisposta piano cottura 2 ante base unit configured for cooker hob 2 doors</p>	110x110	E5471100	125	110	115	122	137	167	171
	110x110	E5471151/2	161	146	151	157	173	203	207
 <p>kit raccordo base angolo junction kit for corner base unit</p>									
 <p>kit raccordo base angolo per inserimento lavastoviglie a destra o sinistra junction kit for corner base unit for dishwasher placed on the right or the left side</p>									
<p>verso dx RH version</p>									

SOTTOLAVELLI

SINK BASE UNITS

H 87 P 61

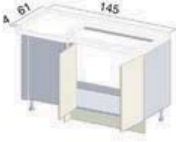

Le basi non sono comprensive di top - N.B.: cerniere ammortizzate di serie The base units do not include the tops - Note: standard blumotion hinges		COD.	MELAMINICO	POLIMERICICO		LACCATO			GLAKS	
			K26	OPACO K27	LUCIDO K27	A K28	B K28	PELTRO K28	K30	
 <p>sottolavello 1 anta sink base unit 1 door</p>	L 45	E5010451/2	131	141	150	149	167	195	214	
	L 60	E5010601/2	145	162	173	174	197	235	245	
 <p>sottolavello 2 ante sink base unit 2 doors</p>	L 60	E5010600	173	185	198	192	216	251	296	
	L 80	E5010800	200	218	234	231	262	310	352	
	L 90	E5010900	206	228	246	244	279	334	373	
	L 120	E5011200	241	274	296	298	345	420	441	
 <p>sottolavello 2 cestoni H 36 cestone superiore sagomato con vaschette sink base unit 2 deep drawers H 36 contoured upper deep drawer with trays</p>	L 60	E5200600	295	307	320	315	339	374	411	
	L 90	E5200900	341	360	378	376	412	466	498	
 <p>sottolavello angolo L 110 1 anta L 45 (cerniere pilastro) cassone 105 corner sink base unit W 110 1 door W 45 (pillar hinges) structure 105</p>	verso dx RH version	110x65	E4421101/2	249	275	287	277	315	353	366
 <p>sottolavello angolo L 125 1 anta L 60 (cerniere pilastro) cassone 120 corner sink base unit W 125 1 door W 60 (pillar hinges) structure 120</p>	verso dx RH version	125x65	E4421251/2	267	299	314	305	350	397	401
 <p>sottolavello angolo L 145 2 ante L 40 (cerniere pilastro) cassone 140 corner sink base unit W 145 2 doors W 40 (pillar hinges) structure 140</p>	verso dx RH version	145x65	E4421451/2	316	349	368	356	409	467	502

SOTTOLAVELLI

SINK BASE UNITS

H 87 P 61

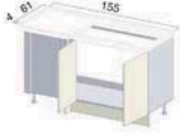
Le basi non sono comprensive di top - N.B.: cerniere ammortizzate di serie
 The base units do not include the tops - Note: standard blumotion hinges

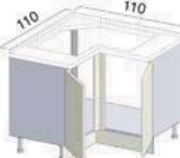
	COD.	MELAMINICO	POLIMERICO		LACCATO			GLAKS	
		K26	OPACO K27	LUCIDO K27	A K28	B K28	PELTRO K28	K30	
 <p>sottolavello angolo L 155 2 ante L 45 (cerniere pilastro) cassone 150 corner sink base unit W 155 2 doors W 45 (pillar hinges) structure 150</p> <p>verso dx RH version</p>	155x65	E4421551/2	327	364	385	374	430	495	528
	95x95	E5020950	330	358	374	359	404	449	494
 <p>sottolavello angolo 95x95 2 ante L 30 (cerniere 180°) corner sink base unit 95x95 2 doors W 30 (180° hinges)</p>	95x95	E5020950	330	358	374	359	404	449	494
	110x110	E5021100	382	419	440	429	485	550	590
 <p>sottolavello angolo 110x110 2 ante L 45 (cerniere 180°) corner sink base unit 110x110 2 doors W 45 (180° hinges)</p>	110x110	E5021100	382	419	440	429	485	550	590

BASI PER ELETTRODOMESTICI SOTTOTOP

H 87 P 61





BASE UNITS FOR UNDER-TOP APPLIANCES

Le basi non sono comprensive di top The base units do not include the tops	COD.	MELAMINICO	POLIMERICO		LACCATO			GLAKS	
		K26	OPACO K27	LUCIDO K27	A K28	B K28	PELTRO K28	K30	
anta per lavastoviglie scomparsa totale door for fully integrated dishwasher 	L 45	E4490080	67	79	88	87	107	136	157
	L 60	E4490090	83	101	113	114	139	180	191
	L 60	E4490100	106	120	133	128	154	191	231
anta per lavastoviglie scomparsa totale estetica 2 cestoni door for fully integrated dishwasher 2 deep drawers aesthetic 	L 45	E4490050	54	64	72	70	86	111	132
	L 60	E4490060	70	83	93	95	117	148	161
	L 60	E4490090	16	16	16	16	16	16	16
kit protezione fianchi per lavastoviglie protection kit for side panels for dishwasher 	coppia couple	08630090	16	16	16	16	16	16	16
	L 60	E4490011/2	83	101	113	114	139	180	191
anta per lavabiancheria scomparsa totale door for fully integrated washing machine 	L 60	E4490011/2	83	101	113	114	139	180	191

BASI PER ELETTRODOMESTICI SOTTOTOP

H 87 P 61

BASE UNITS FOR UNDER-TOP APPLIANCES

Le basi non sono comprensive di top The base units do not include the tops	COD.	MELA- MINICO	POLIMERICO		LACCATO			GLAKS
		K26	OPACO K27	LUCIDO K27	A K28	B K28	PELTRO K28	K30
 anta con fianco per frigo e congelatore sottotop door with side panel for under-top fridge and freezer								
	L 60	E4490151/2	108	126	138	139	161	205
 anta per frigo e congelatore sottotop door for under-top fridge and freezer								
	L 60	E4490181/2	83	101	113	114	139	180
 frontali per frigo a cassettoni fronts for drawer fridge								
	L 90	E4490900	125	146	165	163	198	260
 fianco per elettrodomestici a fine composizione side panel for appliances placed at the end of the composition								
	in nobilitato melamine coated							
	H 84x60x2 zoccolo H 12 plinth	T94612	25	25	25	25	25	25
	H 87x60x2 zoccolo H 15 plinth	T94615	25	25	25	25	25	25
come anta as door								
H 84x59,6x2 zoccolo H 12 plinth	T94702	54	75	88	92	123	171	180
H 87x59,6x2 zoccolo H 15 plinth	T94705	54	75	88	92	123	171	180

BASI H 75 PER TOP H 12

H 75 P 61

LOWERED BASE UNITS H 75 FOR TOP H 12

Le basi non sono comprensive di top - N.B.: cerniere ammortizzate di serie
 The base units do not include the tops - **Note:** standard blumotion hinges





	COD.	MELAMINICO	POLIMERICO		LACCATO			GLAKS	
		K26	OPACO K27	LUCIDO K27	A K28	B K28	PELTRO K28	K30	
 <p>base H 75 1 anta base unit H 75 1 door</p>	L 45	E4030451/2	134	144	152	150	165	188	208
	L 60	E4030601/2	152	164	174	175	196	225	238
 <p>base H 75 2 ante base unit H 75 2 doors</p>	L 90	E4030900	212	232	247	244	274	320	360
	L 120	E4031200	248	273	292	295	336	395	421
 <p>base H 75 2 cassetti H 18 1 cassetto H 24 base unit H 75 2 drawers H 18 1 drawer H 24</p>	L 45	E4250450	280	283	293	294	315	368	394
	L 60	E4250600	313	313	325	324	349	388	435
 <p>base H 75 predisposta per forno H 60 base unit H 75 configured for oven H 60</p>	L 60	E5540600	110	110	110	110	110	110	
 <p>base H 75 predisposta per lavastoviglie REX TCC 800 1 cassetto H 12 base unit H 75 configured for Rex TCC 800 dishwasher 1 drawer H 12</p>	L 60	E4580600	291	299	311	312	337	382	492
 <p>sottolavello H 75 1 anta sink base unit H 75 1 door</p>	L 45	E5060451/2	134	144	151	150	165	187	207
	L 60	E5060601/2	150	162	172	173	193	222	235
 <p>sottolavello H 75 2 ante sink base unit H 75 2 doors</p>	L 90	E5060900	205	224	239	236	265	311	350

BASI SOSPESSE con Attaccaglie e Barre Fissaggio a parete

H 36 - 48 - 60 P 61

HANGING BASE UNITS with Hangers and Rods for wall mounting







Le basi non sono comprensive di top - N.B.: cerniere ammortizzate di serie
 The base units do not include the tops - Note: standard blumotion hinges

	COD.	MELAMINICO	POLIMERICO		LACCATO			GLAKS	
		K26	OPACO K27	LUCIDO K27	A K28	B K28	PELTRO K28	K30	
 <p>base H 36 1 anta base unit H 36 1 door</p>	L 45	E4321451/2	129	134	139	135	145	157	181
	L 60	E4321601/2	141	147	154	151	164	181	199
 <p>base H 48 1 anta base unit H 48 1 door</p>	L 45	E4320451/2	143	149	155	152	164	182	208
	L 60	E4320601/2	158	167	175	173	189	213	234
 <p>base H 60 1 anta base unit H 60 1 door</p>	L 45	E4322451/2	143	153	160	158	173	196	216
	L 60	E4322601/2	161	173	182	183	203	232	245
 <p>base H 36 2 ante base unit H 36 2 doors</p>	L 90	E4321900	185	195	204	198	216	241	289
	L 120	E4322200	207	220	232	228	252	286	323
 <p>base H 48 2 ante base unit H 48 2 doors</p>	L 90	E4320900	212	223	235	230	254	289	340
	L 120	E4321200	238	257	272	269	301	350	391
 <p>base H 60 2 ante base unit H 60 2 doors</p>	L 90	E4322900	214	233	248	245	274	320	359

BASI SOSPESSE con Attaccaglie e Barre Fissaggio a parete

H 36 - 48 P 61

HANGING BASE UNITS with Hangers and Rods for wall mounting

Le basi non sono comprensive di top - N.B.: cassetti e cestoni ad estrazione totale con blumotion The base units do not include the tops - Note: fully extending drawers and deep drawers with blumotion system		COD.	MELAMINICO	POLIMERICICO		LACCATO			GLAKS
			K26	OPACO K27	LUCIDO K27	A K28	B K28	PELTRO K28	K30
 <p>base H 36 1 cestone base H 36 1 deep drawer</p>	L 45	E4311450	170	175	180	177	186	199	222
	L 60	E4311600	187	193	199	197	209	226	245
	L 90	E4311900	218	228	237	236	254	280	297
 <p>base H 48 1 cestone base unit H 48 1 deep drawer</p>	L 45	E4310450	176	181	188	185	197	215	241
	L 60	E4310600	192	201	209	207	223	247	268
	L 90	E4310900	224	239	250	252	276	312	331
 <p>sottolavello H 48 1 cestone sagomato scarico salvaspazio sink base unit H 48 1 contoured deep drawer space-saver drain piping</p>	L 90	E5240900	267	282	293	295	319	355	374
 <p>base H 60 1 cestone 1 cassetto interno base unit H 60 1 deep drawer 1 internal drawer</p>	L 45	E4312450	259	269	277	275	290	312	332
	L 60	E4312600	284	296	306	307	327	356	369
	L 90	E4312900	331	354	368	374	405	448	458
 <p>sottolavello H 60 1 cestone scarico salvaspazio sink base unit H 60 1 deep drawer with space-saver drain piping</p>	L 60	E5250600	237	249	258	260	280	309	321
	L 90	E5250900	267	290	304	310	341	383	394
 <p>sottolavello H 60 1 cestone con pattumiera integrata scarico salvaspazio skin base unit H 60 1 deep drawer with incorporated waste bins space-saver drain piping</p>	L 60	E525060P	321	333	342	343	364	393	405
	L 90	E525090P	338	362	375	381	412	455	466

COMPOSIZIONE CON ELEMENTI INCLINATI

COMPOSITION WITH INCLINED ELEMENTS

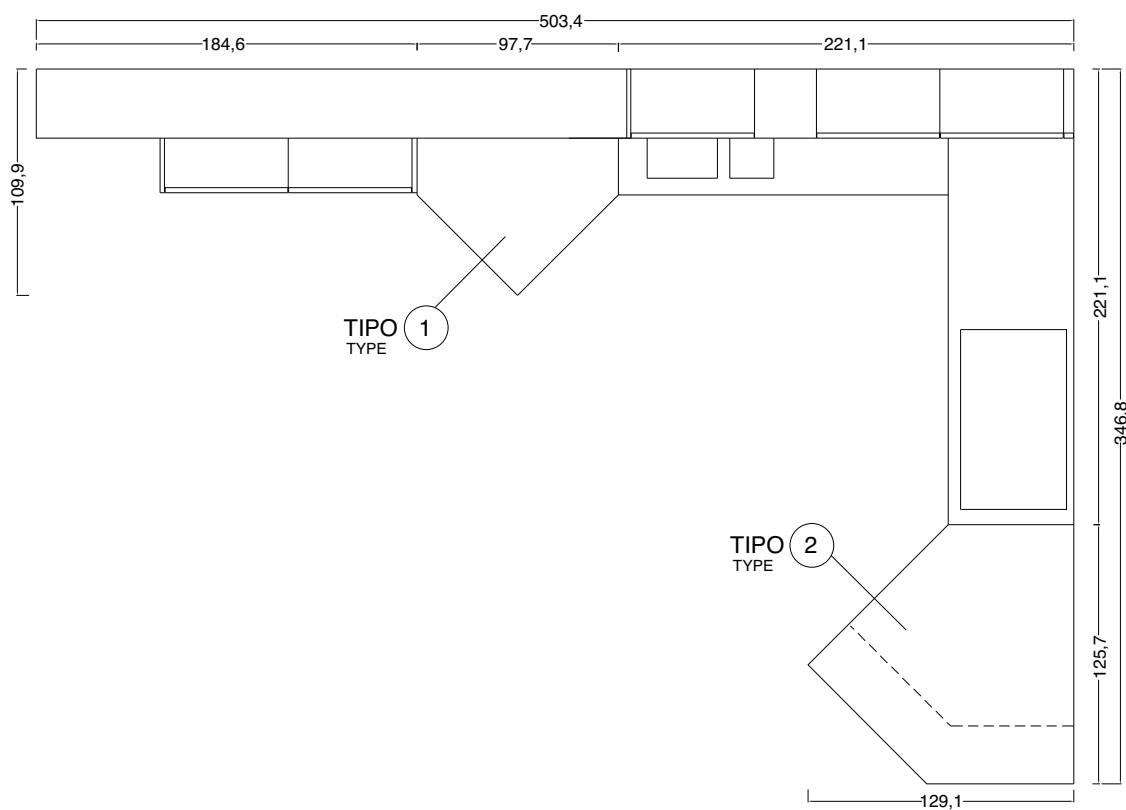
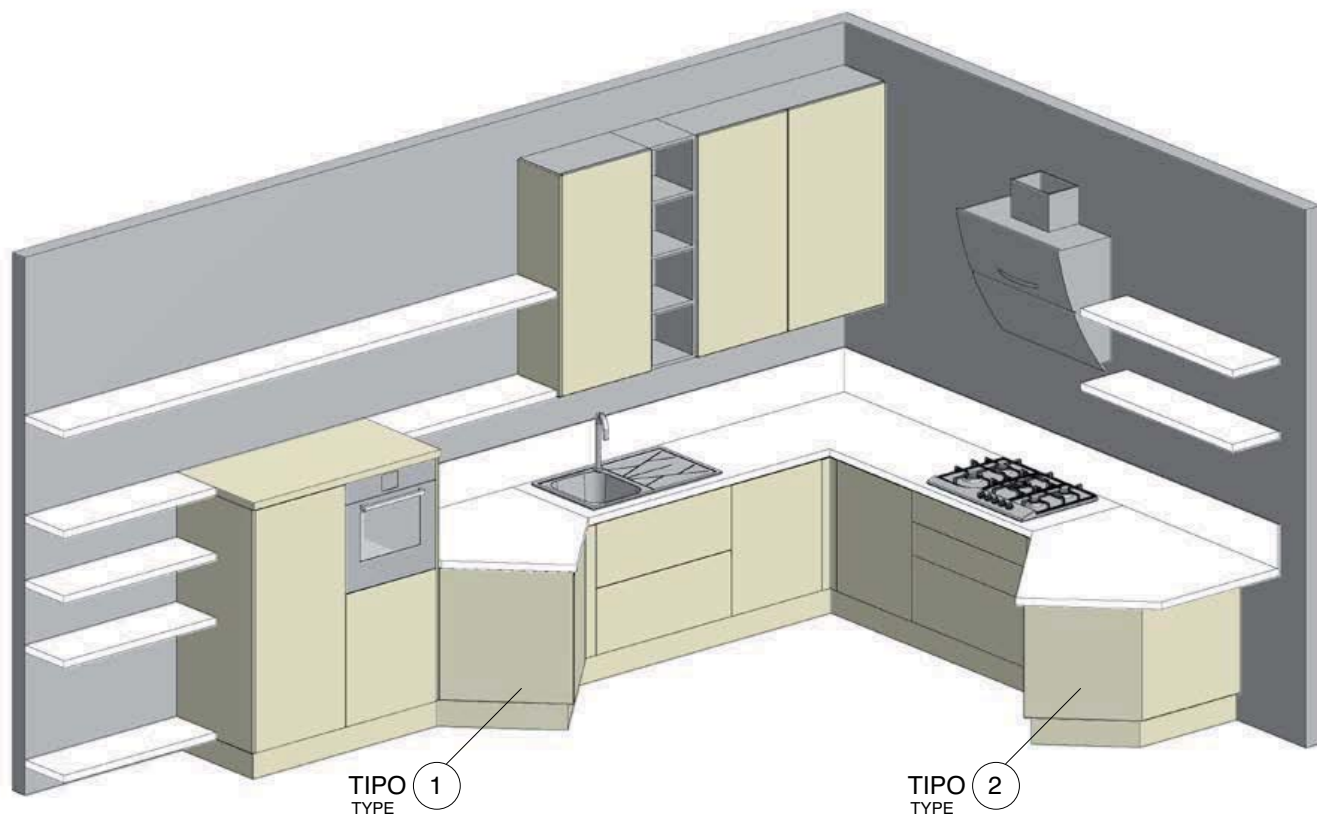

BASE INCLINATA "TIPO 1"

INCLINED BASE UNIT "TYPE 1"

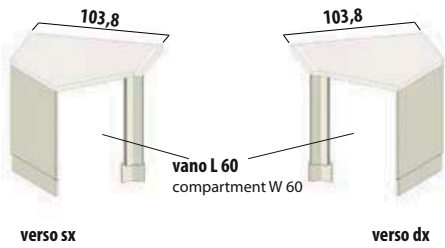
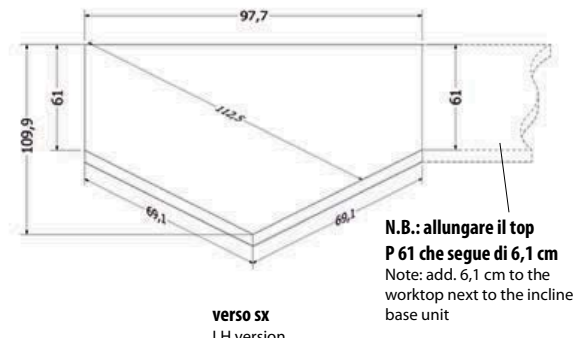
LE BASI NON SONO COMPRENSIVE DI TOP THE BASE UNITS DO NOT INCLUDE THE TOPS	COD.	MELAMINICO	POLIMERICO		LACCATO			GLAKS
		K26	OPACO K27	LUCIDO K27	A K28	B K28	PELTRO K28	K30
kit base inclinata "tipo 1" per vano L 60 inclined base unit "type 1" kit W 60  <p>103,8</p> <p>103,8</p> <p>vano L 60 compartment W 60</p> <p>verso sx LH version</p> <p>verso dx RH version</p>	E4910051/2	138	179	200	197	251	317	323
top per base inclinata "tipo 1" worktop for inclined base unit "type 1"  <p>97,7</p> <p>109,9</p> <p>69,1</p> <p>19</p> <p>19</p> <p>112,5</p> <p>69,1</p> <p>N.B.: allungare il top P 61 che segue di 6,1 cm Note: add. 6,1 cm to the worktop next to the inclined base unit</p> <p>verso sx LH version</p>	97,7x109,9 laminato bordo ABS1							
	H 4 T9062621/2	378	378	378	378	378	378	378
	97,7x109,9 laminato Fenix NTM							
	H 2 TFEN2681/2	428	428	428	428	428	428	428
	H 4 TFEN4681/2	428	428	428	428	428	428	428
	97,7x109,9 quarzo pasta piena profilo P							
	H 2 TQRP2681/2							
	fascia "A"	840	840	840	840	840	840	840
	fascia "B"	896	896	896	896	896	896	896
	fascia "C"	968	968	968	968	968	968	968
	H 3 TQRP3681/2							
	fascia "A"	859	859	859	859	859	859	859
	fascia "B"	952	952	952	952	952	952	952
	fascia "C"	1.024	1.024	1.024	1.024	1.024	1.024	1.024
	97,7x109,9 quarzo bordo quarzo profilo P							
	H 4 TQRP4681/2							
	fascia "A"	1.002	1.002	1.002	1.002	1.002	1.002	1.002
	fascia "B"	1.096	1.096	1.096	1.096	1.096	1.096	1.096
	fascia "C"	1.168	1.168	1.168	1.168	1.168	1.168	1.168

BASE INCLINATA SNACK "TIPO 2"

INCLINED SNACK BASE UNIT "TYPE 2"

LE BASI NON SONO COMPRENSIVE DI TOP
THE BASE UNITS DO NOT INCLUDE THE TOPS

kit base snack "tipo 2" per vano L 60
inclined snack base unit "type 2" kit W 60



top per base snack "tipo 2"
worktop for inclined snack base unit "type 2"

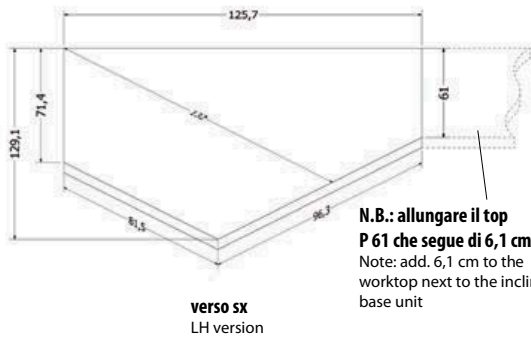

verso sx
LH version

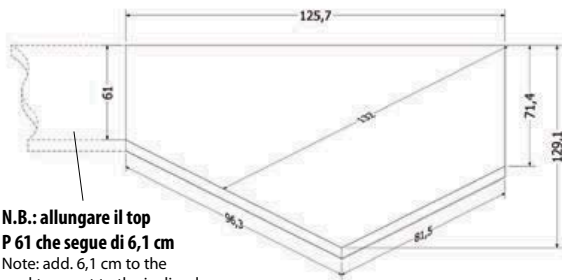

verso dx
RH version

125,7x129,1 laminato bordo ABS1

H 4

T9062631/2 429 429 429 429 429 429 429

125,7x129,1 laminato Fenix NTM

H 2

TFEN2691/2 519 519 519 519 519 519 519

H 4

TFEN4691/2 519 519 519 519 519 519 519

125,7x129,1 quarzo pasta

piena profilo P

H 2

TQRP2691/2

fascia "A"

865 865 865 865 865 865 865

fascia "B"

959 959 959 959 959 959 959

fascia "C"

1.030 1.030 1.030 1.030 1.030 1.030 1.030

H 3

TQRP3691/2

fascia "A"

885 885 885 885 885 885 885

fascia "B"

975 975 975 975 975 975 975

fascia "C"

1.044 1.044 1.044 1.044 1.044 1.044 1.044

Foro rettangolare

T9FRE 85 85 85 85 85 85 85

125,7x129,1 quarzo bordo

quarzo profilo P

H 4

TQRP4691/2

fascia "A"

1.065 1.065 1.065 1.065 1.065 1.065 1.065

fascia "B"

1.158 1.158 1.158 1.158 1.158 1.158 1.158

fascia "C"

1.230 1.230 1.230 1.230 1.230 1.230 1.230





Foro rettangolare

T9FRE 85 85 85 85 85 85 85

COLONNE H 111

COLUMNS H 111





P 59,7

Le colonne non sono comprensive di top - N.B.: cerniere ammortizzate di serie The columns do not include the tops - Note: standard blumotion hinges		COD.	MELAMINICO	POLIMERICO		LACCATO			GLAKS
			K26	OPACO K27	LUCIDO K27	A K28	B K28	PELTRO K28	K30
 <p>fascia tamponamento da 5 a 10 filler panel size 5 to 10</p> <p>96</p>	<p>in nobilitato melamine coated</p> <p>come anta con supporto same as door with support</p>	E6000010	30	30	30	30	30	30	30
		E6000140	80	97	104	132	157	161	158
 <p>1 anta 1 door</p>	<p>L 30</p> <p>L 40</p> <p>L 45</p> <p>L 60</p>	E6040301/2	177	186	195	193	210	235	253
		E6040401/2	188	202	213	214	237	270	290
		E6040451/2	193	209	221	222	247	287	306
		E6040601/2	219	243	258	262	296	349	359
 <p>2 ante 2 doors</p>	L 90	E6041900	293	325	349	351	402	481	519
 <p>1 anta vetro 1 glass door</p>	<p>telaio peltro-polimerico L 45 pewter-polymeric frame</p> <p>telaio alluminio 419S L 45 aluminium frame</p>	E6046451/2	366	278	285	366	366	366	—
		E6047451/2	296	296	296	296	296	296	—
 <p>2 ante vetro 2 glass doors</p>	<p>telaio peltro-polimerico L 90 pewter-polymeric frame</p> <p>telaio alluminio 419S L 90 aluminium frame</p>	E6046900	649	472	486	649	649	649	—
		E6047900	515	515	515	515	515	515	—

COLONNE H 111

COLUMNS H 111

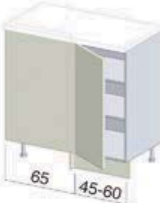

P 59,7

Le colonne non sono comprensive di top - N.B.: cassetti e cestoni ad estrazione totale con blumotion The columns do not include the tops - Note: fully extending drawers and deep drawers with blumotion system		COD.	MELA-MINICO	POLIMERICO		LACCATO			GLAKS
			K26	OPACO K27	LUCIDO K27	A K28	B K28	PELTRO K28	K30
 <p>1 cassetto H 24 2 cestoni H 36 1 drawer H 24 2 deep drawers H 36</p>	L 60	E6031620	372	385	403	399	433	474	532
	 <p>1 cassetto H 24 1 cestone H 36 1 cestone vetro H 36 1 drawer H 24 1 deep drawer H 36 1 glass deep drawer H 36</p>								
		telaio petro-polimerico L 60 pewter-polymeric frame	E6031610	479	439	457	496	518	542
	telaio alluminio 419S L 60 aluminium frame	E6032610	453	461	472	470	492	516	—
 <p>angolo 2 ripiani 1 anta (cerniere a pilastro) pannello come anta sp. 2,2 (pannello finitura legno venature verticali) corner unit 2 shelves 1 door (pillar hinges) panel as door Th. 2,2 (wooden finish panel with vertical grains)</p>	L 110	E6327101/2	375	381	409	411	472	509	604
	L 125	E6327251/2	390	390	420	420	489	539	624
 <p>jolly colonna L da 10 a 30 in nobilitato jolly column size 10 to 30 melamine coated</p>									
		colore come struttura same colour as carcass	E6000900	170	170	170	170	170	170

COLONNE H 147

COLUMNS H 147

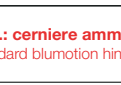
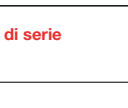

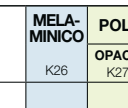
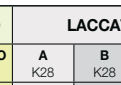

P 59,7

Le colonne non sono comprensive di top - N.B.: cerniere ammortizzate di serie The columns units do not include the tops - Note: standard blumotion hinges		COD.	MELAMINICO	POLIMERICO		LACCATO			GLAKS
			K26	OPACO K27	LUCIDO K27	A K28	B K28	PELTRO K28	K30
 <p>fascia tamponamento da 5 a 10 filler panel size 5 to 10</p> <p>132</p>									
	<p>in nobilitato melamine coated</p>	E6000020	32	32	32	32	32	32	32
	<p>come anta con supporto same as door with support</p>	E6000150	90	107	117	132	156	160	158
 <p>1 anta 1 door</p>									
	L 30	E6050301/2	205	219	230	233	257	289	322
	L 45	E6050451/2	226	250	266	275	311	360	387
	L 60	E6050601/2	254	288	309	318	364	438	451
 <p>2 ante 2 doors</p>									
	L 90	E6050900	348	396	429	446	519	616	670
 <p>1 anta vetro 1 glass door</p>									
	telaio polimerico L 45 polimeric frame	E6180451/2	—	322	339	—	—	—	—
	L 60	E6180601/2	—	381	403	—	—	—	—
	telaio alluminio 419S L 45 aluminium frame	E6182451/2	363	363	363	363	363	363	—
	L 60	E6182601/2	407	407	407	407	407	—	
 <p>2 ante vetro 2 glass doors</p>									
	telaio polimerico L 90 polimeric frame	E6180900	—	547	581	—	—	—	—
	telaio alluminio 419S L 90 aluminium frame	E6182900	628	628	628	628	628	628	—
 <p>1 anta integrata al gruppo cestelli estraibili in filo cromati chiusura soft 1 door incorporated into the chromed wire pull-out basket drawer unit soft-closing system</p>									
	L 30	E6150300	450	463	474	477	500	529	560

COLONNE H 147

COLUMNS H 147

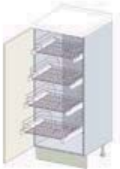

P 59,7

Le colonne non sono comprensive di top - N.B.: cerniere ammortizzate di serie The columns units do not include the tops - Note: standard blumotion hinges		COD.	MELA-MINICO	POLIMERICO		LACCATO			GLAKS
			K26	OPACO K27	LUCIDO K27	A K28	B K28	PELTRO K28	K30
 <p>1 anta gruppo cestelli estraibili in filo cromati chiusura soft 1 door chromed wire pull-out basket drawer unit soft-closing system</p>	L 45	E6150451/2	474	497	512	520	555	600	626
	L 60	E6150601/2	517	550	569	578	621	691	704
 <p>1 anta vetro gruppo cestelli estraibili in filo cromati chiusura soft 1 glass door chromed wire pull-out basket drawer unit soft-closing system</p>	telaio polimerico L 45 polymeric frame	E6152451/2	—	586	603	—	—	—	—
	L 60	E6152601/2	—	664	686	—	—	—	—
	telaio alluminio 419S L 45 aluminium frame	E6152461/2	641	641	641	641	641	641	—
	L 60	E6152611/2	703	703	703	703	703	703	—
 <p>1 anta 4 cestelli cromati estraibili singolarmente 1 door 4 independent chromed pull-out basket units</p>	L 45	E6155451/2	489	512	527	535	570	615	641
	L 60	E6155601/2	529	562	581	590	633	703	715
 <p>2 ante 4 cestelli estraibili cromati girevoli 2 doors 4 swivel chromed basket drawers</p>	L 90	E6150900	873	918	949	966	1.034	1.125	1.176
	 <p>2 ante vetro 4 cestelli estraibili cromati girevoli 2 glass doors 4 swivel chromed basket drawers</p>	telaio polimerico L 90 polymeric frame	E6150910	—	1.096	1.131	—	—	—
telaio alluminio 419S L 90 aluminium frame		E6150920	1.210	1.210	1.210	1.210	1.210	1.210	—

COLONNE H 147

P 59,7

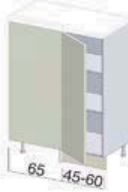



COLUMNS H 147

Le colonne non sono comprensive di top - N.B.: cerniere ammortizzate di serie The columns units do not include the tops - Note: standard blumotion hinges	COD.	MELA-MINICO	POLIMERICO		LACCATO			GLAKS	
		K26	OPACO K27	LUCIDO K27	A K28	B K28	PELTRO K28	K30	
 <p>*1 anta (cerniere 180°) 1 cassetto interno 3 cestoni interni *1 door (180° hinges) 1 internal drawer 3 internal deep drawers</p>	L 45	E6158481/2	508	531	546	555	589	634	660
	L 60	E6158631/2	556	588	608	616	660	729	742
<p>*LE COLONNE CON CASSETTI E CESTONI INTERNI VANNO SEMPRE POSIZIONATE A 5 CM DALLA PARETE LATERALE *Columns with drawers and deep drawers should always be placed at 5 cm from the side wall</p>									
 <p>angolo 2 ripiani 1 anta (cerniere a pilastro) pannello come anta sp.2,2 (pannello finitura legno venature verticali) corner unit 2 shelves 1 door (hinges pillar) panel as door Th. 2,2 (wooden finish panel with vertical grains)</p>	L 110	E6336101/2	515	463	501	509	595	640	761
	L 125	E6336251/2	530	475	515	521	616	684	793
 <p>jolly colonna L da 10 a 30 in nobilitato jolly column size 10 to 30 melamine coated</p>									
		colore come struttura same colour as carcass	E6001000	203	203	203	203	203	203

COLONNE H 219

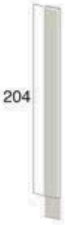
COLUMNS H 219

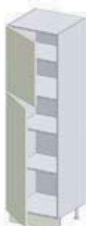

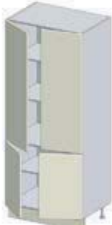

P 33,2 - 59,7

	COD.	MELAMINICO	POLIMERICO		LACCATO			GLAKS	
		K26	OPACO K27	LUCIDO K27	A K28	B K28	PELTRO K28	K30	
 <p>fascia tamponamento da 5 a 10 N.B.: nelle finiture legno per la versione in polimerico viene realizzata in 2 pezzi filler panel size 5 to 10 Note: produced in 2 pieces for wooden finishes of polymeric version</p>									
	in nobilitato melamine coated	E6000050	38	38	38	38	38	38	38
	come anta con supporto same as door with support	E6000200	130	144	157	168	204	210	205
 <p>2 ante anta superiore H 72 anta inferiore H 132 2 doors upper door H 72 lower door H 132</p>	L 45 P 33,2	E6013451/2	276	313	339	347	403	483	531
	L 60 P 33,2	E6013601/2	325	381	415	426	502	623	649
 <p>2 ante anta superiore H 72 anta inferiore H 132 2 doors upper door H 72 lower door H 132</p>	L 30 P 59,7	E6060301/2	294	314	333	333	371	422	480
	L 45 P 59,7	E6063451/2	328	364	390	398	455	534	583
	L 60 P 59,7	E6063601/2	385	441	476	486	562	684	710
 <p>2 ante anta superiore H 132 anta inferiore H 72 2 doors upper door H 132 lower door H 72</p>	L 45 P 33,2	E6010451/2	276	313	339	347	403	483	531
	L 60 P 33,2	E6010601/2	325	381	415	426	502	623	649
 <p>2 ante anta superiore H 132 anta inferiore H 72 2 doors upper door H 132 lower door H 72</p>	L 45 P 59,7	E6060451/2	328	364	390	398	455	534	583
	L 60 P 59,7	E6060601/2	385	441	476	486	562	684	710
 <p>4 ante 2 ante superiori H 132 2 ante inferiori H 72 4 doors 2 upper doors H 132 2 lower doors H 72</p>	L 90 P 59,7	E6060900	527	600	652	668	781	939	1.036

COLONNE H 219

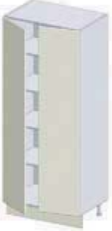
COLUMNS H 219

P 59,7







	COD.	MELAMINICO	POLIMERICO		LACCATO			GLAKS	
		K26	OPACO K27	LUCIDO K27	A K28	B K28	PELTRO K28	K30	
 <p>1 anta H 204 N.B.: non disponibile per le finiture legno nella versione polimerico 1 door H 204 Note: Not available for wooden finishes of polymeric version</p>	L 45	E6061451/2	322	374	399	403	459	540	592
	L 60	E6061601/2	364	430	463	477	555	669	708
	L 90	E6061900	482	586	635	644	756	918	1.021
 <p>2 ante H 204 N.B.: non disponibile per le finiture legno nella versione polimerico 2 doors H 204 Note: Not available for wooden finishes of polymeric version</p>	L 30	E6100301/2	302	323	342	341	379	430	488
	L 45	E6100451/2	323	360	386	394	450	529	578
 <p>portascope 2 ante anta superiore H 72 anta inferiore H 132 broom cabinet 2 doors upper door H 72 lower door H 132</p>	L 30	E6100301/2	302	323	342	341	379	430	488
	L 45	E6100451/2	323	360	386	394	450	529	578
 <p>portascope con ripiani 2 ante anta superiore H 72 anta inferiore H 132 broom cabinet with shelves 2 doors upper door H 72 lower door H 132</p>	L 60	E6100601/2	398	453	488	499	575	696	722
	L 45	E6065451/2	498	524	551	560	621	743	798
 <p>1 anta H 132 4 cassetti H 18 1 door H 132 4 drawers H 18</p>	L 60	E6065601/2	556	586	621	624	697	831	895
	L 45	E6065461/2	452	481	507	512	569	665	728
 <p>1 anta H 132 2 cassetti H 18 1 cestone H 36 1 door H 132 2 drawers H 18 1 deep drawer H 36</p>	L 45	E6065461/2	452	481	507	512	569	665	728
	L 60	E6065611/2	503	541	574	578	648	766	823

COLONNE H 219

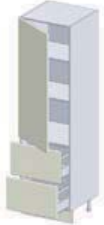
COLUMNS H 219

P 33,2 - 59,7





N.B.: cassetti e cestoni ad estrazione totale con blumotion
 Note: fully extending drawers and deep drawers with blumotion system

	COD.	MELAMINICO	POLIMERICICO		LACCATO			GLAKS	
		K26	OPACO K27	LUCIDO K27	A K28	B K28	PELTRO K28	K30	
 <p>1 anta H 132 2 cestoni H 36 1 door H 132 2 deep drawers H 36</p>	L 45 P 59,7	E6066451/2	405	437	462	464	517	587	659
	L 60 P 59,7	E6066601/2	450	495	527	531	598	701	751
 <p>2 ante vetro anta superiore H 132 anta inferiore H 72 2 glass doors upper door H 132 lower door H 72</p>	telaio polimerico L 45 P 33,2 polymeric frame	E6200461/2	—	439	465	—	—	—	—
	L 60 P 33,2	E6200611/2	—	527	562	—	—	—	—
	telaio alluminio 419S L 45 P 33,2 aluminium frame	E6203461/2	541	541	541	541	541	541	—
	L 60 P 33,2	E6203611/2	578	578	578	578	578	578	—
 <p>2 ante vetro anta superiore H 132 anta inferiore H 72 2 glass doors upper door H 132 lower door H 72</p>	telaio polimerico L 45 P 59,7 polymeric frame	E6200451/2	—	486	513	—	—	—	—
	L 60 P 59,7	E6200601/2	—	578	613	—	—	—	—
	telaio alluminio 419S L 45 P 59,7 aluminium frame	E6203451/2	557	557	557	557	557	557	—
	L 60 P 59,7	E6203601/2	629	629	629	629	629	629	—
 <p>2 ante anta vetro H 132 anta chiusa H 72 2 doors glass door H 132 full door H 72</p>	telaio polimerico L 45 P 33,2 polymeric frame	E6202451/2	—	377	403	—	—	—	—
	L 60 P 33,2	E6202601/2	—	448	481	—	—	—	—
	telaio alluminio 419S L 45 P 33,2 aluminium frame	E6205451/2	387	398	407	406	424	451	—
	L 60 P 33,2	E6205601/2	436	452	463	464	488	525	—
 <p>2 ante anta vetro H 132 anta chiusa H 72 2 doors glass door H 132 full door H 72</p>	telaio polimerico L 45 P 59,7 polymeric frame	E6201451/2	—	423	448	—	—	—	—
	L 60 P 59,7	E6201601/2	—	499	533	—	—	—	—
	telaio alluminio 419S L 45 P 59,7 aluminium frame	E6204451/2	433	444	453	452	470	497	—
	L 60 P 59,7	E6204601/2	487	503	515	516	539	577	—
 <p>4 ante 2 ante vetro H 132 2 ante chiuse H 72 4 doors 2 glass doors H 132 2 full doors H 72</p>	telaio polimerico L 90 P 59,7 polymeric frame	E6201900	—	731	783	—	—	—	—
	telaio alluminio 419S L 90 P 59,7 aluminium frame	E6204900	753	775	792	790	826	881	—

COLONNE H 219

COLUMNS H 219

P 59,7





	COD.	MELAMINICO	POLIMERICO		LACCATO			GLAKS	
		K26	OPACO K27	LUCIDO K27	A K28	B K28	PELTRO K28	K30	
 <p>1 anta vetro H 132 4 cassetti H 18 1 glass door H 132 4 drawers H 18</p>									
	telaio polimerico L 45 polymeric frame	E6284451/2	—	612	641	—	—	—	—
	L 60	E6284601/2	—	700	737	—	—	—	—
	telaio alluminio 419S L 45 aluminium frame	E6287451/2	631	633	645	647	673	751	—
	L 60	E6287601/2	706	704	719	714	744	809	—
 <p>1 anta vetro H 132 2 cassetti H 18 1 cestone H 36 1 glass door H 132 2 drawers H 18 1 deep drawer H 36</p>									
	telaio polimerico L 45 polymeric frame	E6284461/2	—	569	597	—	—	—	—
	L 60	E6284611/2	—	655	690	—	—	—	—
	telaio alluminio 419S L 45 aluminium frame	E6287461/2	584	590	601	598	621	672	—
	L 60	E6287611/2	651	657	670	666	693	742	—
 <p>1 anta vetro H 132 2 cestoni H 36 1 glass door H 132 2 deep drawers H 36</p>									
	telaio polimerico L 45 polymeric frame	E6285451/2	—	526	553	—	—	—	—
	L 60	E6285601/2	—	607	641	—	—	—	—
	telaio alluminio 419S L 45 aluminium frame	E6288451/2	538	547	557	550	569	594	—
	L 60	E6288601/2	600	613	625	621	645	679	—
 <p>anta H 204 integrata al gruppo cestelli estraibili in filo cromati chiusura soft N.B.: non disponibile per le finiture legno nella versione polimerico door H 204 incorporated into the chromed wire pull-out basket unit soft-closing system Note: Not available for wooden finishes of polymeric version</p>									
	L 30	E6163300	609	646	659	657	692	737	780
	L 45	E6163450	660	710	731	735	787	862	902
 <p>anta H 204 unite (132+72) integrata al gruppo cestelli estraibili in filo cromati chiusura soft N.B.: disponibile per le finiture legno nella versione polimerico joint doors H 204 (132+72) incorporated into the chromed wire pull-out basket drawer unit soft-closing system Note: available for wooden finishes of polymeric version</p>									
	L 30	E6164300	—	658	671	—	—	—	—
	L 45	E6164450	—	725	745	—	—	—	—

COLONNE H 219

P 59,7

COLUMNS H 219

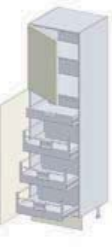

N.B.: cassetti e cestoni ad estrazione totale con blumotion
 Note: fully extending drawers and deep drawers with blumotion system

	COD.	MELAMINICO	POLIMERICO		LACCATO			GLAKS	
		K26	OPACO K27	LUCIDO K27	A K28	B K28	PELTRO K28	K30	
 <p>1 anta superiore H 72 1 anta H 132 integrata al gruppo cestelli estraibili in filo cromati chiusura soft 1 upper door H 72 1 door H 132 incorporated into the chromed wire pull-out basket drawer unit soft-closing system</p>	L 30	E6160301/2	533	552	570	569	605	652	705
 <p>1 anta superiore H 72 1 anta inferiore H 132 gruppo cestelli estraibili in filo cromati chiusura soft 1 upper door H 72 1 lower door H 132 chromed wire pull-out basket drawer unit soft-closing system</p>	L 45	E6160451/2	572	606	630	637	690	763	808
	L 60	E6160601/2	628	677	708	717	785	892	915
 <p>1 anta superiore H 72 (cerniere 100°) 1 anta inferiore H 132 (cerniere 180°) 1 cassetto interno 3 cestoni interni posizionare sempre a 5 cm dalla parete laterale 1 upper door H 72 (100° hinges) 1 lower door H 132 (180° hinges) 1 internal drawer 3 internal deep drawers should always be placed at 5 cm from the side wall</p>	L 45	E6086481/2	578	612	635	643	695	767	812
	L 60	E6086631/2	637	686	716	726	792	899	922
 <p>jolly colonna L da 15 a 30 in nobilitato jolly column size 15 to 30 melamine coated</p>									
		colore come struttura same colour as carcass	E6002000	239	239	239	239	239	239

COLONNE ANGOLO H 219

P 59,7





CORNER COLUMNS H 219

	COD.	MELAMINICO	POLIMERICO		LACCATO			GLAKS	
		K26	OPACO K27	LUCIDO K27	A K28	B K28	PELTRO K28	K30	
 <p>angolo 4 ripiani 1 anta superiore H 72 1 anta inferiore H 132 (cerniere a pilastro) pannello come anta sp.2,2 (pannello finiture legno venature verticali) corner unit 4 shelves 1 upper door H 72 1 lower door H 132 (pillar hinges) panel as door Th. 2,2 (wooden finish panel with vertical grains)</p>	L 110 P 59,7	E6306101/2	652	679	737	743	875	947	1.135
	L 125 P 59,7	E6306251/2	668	690	750	763	909	1.016	1.182
 <p>angolo 1 anta H 204 (132+72) cerniere 135° 2 fianchi sp. 3,8 come struttura N.B.: fornita smontata corner 1 door H 204 (132+72) 135° hinges 2 side panels Th.3,8 same as carcass Note: supplied unassembled</p>	105,5x105,5	E6341051/2	918	983	998	1.090	1.103	1.191	1.227

COLONNE H 243

COLUMNS H 243

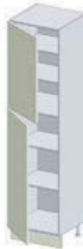
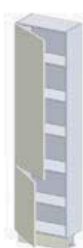



P 33,2 - 59,7

	COD.	MELAMINICO	POLIMERICO		LACCATO			GLAKS	
		K26	OPACO K27	LUCIDO K27	A K28	B K28	PELTRO K28	K30	
 <p>fascia tamponamento da 5 a 10 N.B.: nelle finiture legno per la versione in polimerico viene realizzata in 2 pezzi filler panel size 5 to 10 Note: produced in 2 pieces for wooden finishes of polymeric version</p>									
	in nobilitato melamine coated	E6000100	38	38	38	38	38	38	38
	come anta con supporto same as door with support	E6000250	135	150	166	169	204	214	211
 <p>2 ante anta superiore H 96 anta inferiore H 132 2 doors upper door H 96 lower door H 132</p>	L 45 P 33,2	E6023451/2	302	343	372	382	445	534	516
	L 60 P 33,2	E6023601/2	360	422	460	474	559	695	720
 <p>2 ante anta superiore H 96 anta inferiore H 132 2 doors upper door H 96 lower door H 132</p>	L 30 P 59,7	E6070301/2	319	342	363	364	406	463	516
	L 45 P 59,7	E6073451/2	358	399	428	438	501	590	637
	L 60 P 59,7	E6073601/2	426	488	527	541	626	761	786
 <p>2 ante anta superiore H 156 (anta unita 132+24 nelle finiture legno per la versione polimerico) anta inferiore H 72 2 doors upper door H 156 (joint doors 132+24 for wooden finishes of polymeric version) lower door H 72</p>	L 45 P 33,2	E6020451/2	300	343	372	378	439	534	598
	L 60 P 33,2	E6020601/2	355	418	457	473	558	691	731
 <p>2 ante anta superiore H 156 (anta unita 132+24 nelle finiture legno per la versione polimerico) anta inferiore H 72 2 doors upper door H 156 (joint doors 132+24 for wooden finishes of polymeric version) lower door H 72</p>	L 45 P 59,7	E6070451/2	356	399	428	434	495	590	654
	L 60 P 59,7	E6070601/2	421	485	523	539	625	758	797
 <p>4 ante 2 ante superiori H 156 (anta unita 132+24 nelle finiture legno per la versione polimerico) 2 ante inferiori H 72 4 doors 2 upper doors H 156 (joint doors 132+24 for wooden finishes of polymeric version) 2 lower doors H 72</p>	L 90 P 59,7	E6070900	571	658	715	727	850	1.040	1.168

COLONNE H 243

P 33,2 - 59,7







COLUMNS H 243

	COD.	MELAMINICO	POLIMERICO		LACCATO			GLAKS	
		K26	OPACO K27	LUCIDO K27	A K28	B K28	PELTRO K28	K30	
 <p>portascope 1 anta superiore H 96 1 anta inferiore H 132 broom cabinet 1 upper door H 96 1 lower door H 132</p>	L 30 P 59,7	E6110301/2	335	357	378	379	421	479	531
	L 45 P 59,7	E6110451/2	354	395	424	434	496	586	633
	L 60 P 59,7	E6110601/2	426	488	526	540	625	761	786
 <p>portascope con ripiani 1 anta superiore H 96 1 anta inferiore H 132 broom cabinet with shelves 1 upper door H 96 1 lower door H 132</p>	L 45 P 59,7	E6075451/2	524	555	585	593	657	795	863
	L 60 P 59,7	E6075601/2	587	624	662	670	752	896	972
	L 45 P 59,7	E6075461/2	477	512	541	545	605	716	794
 <p>1 anta H 156 (anta unita 132+24 nelle finiture legno per la versione polimerico) 4 cassetti H 18 1 door H 156 (joint doors 132+24 for wooden finishes of polymeric version) 4 drawers H 18</p>	L 45 P 59,7	E6075461/2	477	512	541	545	605	716	794
	L 60 P 59,7	E6075611/2	534	579	615	623	702	831	899
	L 45 P 59,7	E6076451/2	431	469	496	496	553	638	725
 <p>1 anta H 156 (anta unita 132+24 nelle finiture legno per la versione polimerico) 2 cassetti H 18 1 cestone H 36 1 door H 156 (joint doors 132+24 for wooden finishes of polymeric version) 2 drawers H 18 1 deep drawer H 36</p>	L 45 P 59,7	E6076451/2	431	469	496	496	553	638	725
	L 60 P 59,7	E6076601/2	481	533	568	577	653	766	827
	L 45 P 59,7	E6210461/2	—	484	514	—	—	—	—
 <p>2 ante vetro anta superiore H 156 (anta unita 132 vetro+24 piena nelle finiture legno per la versione polimerico) anta inferiore H 72 2 glass doors upper door H 156 (joint glass door 132+full door 24 for wooden finishes of polymeric version) lower door H 72</p>	telaio polimerico L 45 P 33,2 polymeric frame	E6210461/2	—	484	514	—	—	—	—
	telaio alluminio 419S L 45 P 33,2 aluminium frame	E6213461/2	552	552	552	552	552	552	—
	L 45 P 33,2	E6213461/2	552	552	552	552	552	552	—

COLONNE H 243

COLUMNS H 243





P 33,2 - 59,7

N.B.: cassetti e cestoni ad estrazione totale con blumotion Note: fully extending drawers and deep drawers with blumotion system	COD.	MELA-MINICO	POLIMERICICO		LACCATO			GLAKS
		K26	OPACO K27	LUCIDO K27	A K28	B K28	PELTRO K28	K30
 <p>2 ante vetro anta superiore H 156 (anta unita 132 vetro+24 piena nelle finiture legno per la versione polimerico) anta inferiore H 72 2 glass doors upper door H 156 <i>(joint glass door 132+full door 24 for wooden finishes of polymeric version)</i> lower door H 72</p>								
	<p>telaio polimerico L 45 P 59,7 polymeric frame telaio alluminio 419S L 45 P 59,7 aluminium frame</p>	E6210451/2	—	536	566	—	—	—
	E6213451/2	602	602	602	602	602	602	—
 <p>2 ante anta vetro H 156 (anta unita 132 vetro+24 piena nelle finiture legno per la versione polimerico) anta chiusa H 72 2 doors glass door H 156 <i>(joint glass door 132+full door 24 for wooden finishes of polymeric version)</i> full door H 72</p>								
	<p>telaio polimerico L 45 P 33,2 polymeric frame telaio alluminio 419S L 45 P 33,2 aluminium frame</p>	E6212451/2	—	421	450	—	—	—
	E6215451/2	426	437	446	445	463	490	—
 <p>2 ante anta vetro H 156 (anta unita 132 vetro+24 piena nelle finiture legno per la versione polimerico) anta chiusa H 72 2 doors glass door H 156 <i>(joint glass door 132+full door 24 for wooden finishes of polymeric version)</i> full door H 72</p>								
	<p>telaio polimerico L 45 P 59,7 polymeric frame telaio alluminio 419S L 45 P 59,7 aluminium frame</p>	E6211451/2	—	473	501	—	—	—
	E6214451/2	478	489	497	496	514	542	—
 <p>4 ante 2 ante vetro H 156 (anta unita 132 vetro+24 piena nelle finiture legno per la versione polimerico) 2 ante chiuse H 72 4 doors 2 glass doors H 156 <i>(joint glass door 132+full door 24 for wooden finishes of polymeric version)</i> 2 full doors H 72</p>								
	<p>telaio polimerico L 90 P 59,7 polymeric frame telaio alluminio 419S L 90 P 59,7 aluminium frame</p>	E6211900	—	821	879	—	—	—
	E6214900	831	853	870	868	904	959	—
 <p>1 anta vetro H 156 (anta unita 132 vetro+24 piena nelle finiture legno per la versione polimerico) 4 cassetti H 18 1 glass door H 156 <i>(joint glass door 132+full door 24 for wooden finishes of polymeric version)</i> 4 drawers H 18</p>								
	<p>telaio polimerico L 45 P 59,7 polymeric frame telaio alluminio 419S L 45 P 59,7 aluminium frame</p>	E6294451/2	—	662	694	—	—	—
	E6297451/2	675	678	690	691	717	795	—
 <p>1 anta vetro H 156 (anta unita 132 vetro+24 piena nelle finiture legno per la versione polimerico) 2 cassetti H 18 1 cestone H 36 1 glass door H 156 <i>(joint glass door 132+full door 24 for wooden finishes of polymeric version)</i> 2 drawers H 18 1 deep drawer H 36</p>								
	<p>telaio polimerico L 45 P 59,7 polymeric frame telaio alluminio 419S L 45 P 59,7 aluminium frame</p>	E6294461/2	—	619	649	—	—	—
	E6297461/2	629	635	645	643	665	717	—

COLONNE H 243

COLUMNS H 243

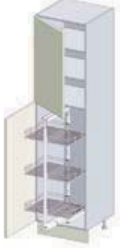
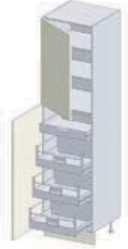
P 59,7

	COD.	MELAMINICO	POLIMERICO		LACCATO			GLAKS	
		K26	OPACO K27	LUCIDO K27	A K28	B K28	PELTRO K28	K30	
 <p>1 anta vetro H 156 (anta unita 132 vetro+24 piena nelle finiture legno per la versione polimerico) 2 cestoni H 36 1 glass door H 156 (joint glass door 132+full door 24 for wooden finishes of polymeric version) 2 deep drawers H 36</p>									
	<p>telaio polimerico L 45 polymeric frame</p> <p>telaio alluminio 419S L 45 aluminium frame</p>	E6295451/2	—	576	605	—	—	—	—
 <p>1 anta superiore H 96 1 anta H 132 integrata al gruppo cestelli estraibili in filo cromati chiusura soft 1 upper door H 96 1 door H 132 incorporated into the chromed wire pull-out basket drawer unit soft-closing system</p>									
	L 30	E6170301/2	557	578	598	598	637	691	739
 <p>1 anta superiore H 96 1 anta inferiore H 132 gruppo cestelli estraibili in filo cromati chiusura soft 1 upper door H 96 1 lower door H 132 chromed wire pull-out basket drawer unit soft-closing system</p>									
	L 45	E6170451/2	600	638	665	674	732	815	859
	L 60	E6170601/2	665	720	754	766	841	961	982
 <p>*1 anta superiore H 96 (cerniere 100°) 1 anta inferiore H 132 (cerniere 180°) 1 cassetto interno 3 cestoni interni *1 upper door H 96 (100° hinges) 1 lower door H 132 (180° hinges) 1 internal drawer 3 internal deep drawers</p>									
	L 45	E6088481/2	606	643	670	679	737	819	862
	L 60	E6088631/2	673	727	761	773	848	967	989
<p>*LE COLONNE CON CASSETTI E CESTONI INTERNI VANNO SEMPRE POSIZIONATE A 5 CM DALLA PARETE LATERALE *Columns with drawers and deep drawers should always be placed at 5 cm from the side wall</p>									
 <p>jolly colonna L da 15 a 30 in nobilitato jolly column size 15 to 30 melamine coated</p>									
	colore come struttura same colour as carcass	E6003000	267	267	267	267	267	267	267

COLONNE ANGOLO H 243

P 59,7



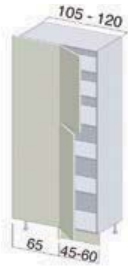
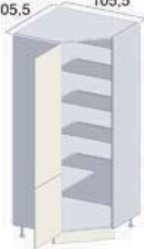

CORNER COLUMNS H 243

	COD.	MELAMINICO	POLIMERICO		LACCATO			GLAKS	
		K26	OPACO K27	LUCIDO K27	A K28	B K28	PELTRO K28	K30	
 <p>angolo 5 ripiani 1 anta superiore H 96 1 anta inferiore H 132 (cerniere a pilastro) pannello come anta sp. 2,2 (pannello finiture legno venature verticali) corner unit 5 shelves 1 upper door H 96 1 lower door H 132 (pillar hinges) panel as door Th. 2,2 (wooden finish panel with vertical grains)</p>	L 110 P 59,7	E6316101/2	693	743	808	820	964	1.046	1.207
	L 125 P 59,7	E6316251/2	717	760	831	851	1.012	1.131	1.271
 <p>angolo 1 anta H 228 (156+72) cerniere 135° (anta unita 24+132+72 nelle finiture legno per la versione polimerico) 2 fianchi sp. 3,8 come struttura N.B.: fornita smontata corner 1 door H 228 (156+72) 135° hinges (joint doors 24+132+72 for wooden finishes of polymeric version) 2 side panels Th.3,8 same as carcass Note: supplied unassembled</p>	105,5x105,5	E6342051/2	1.015	1.073	1.108	1.107	1.185	1.306	1.342

COLONNE H 111 PER FORNO

P 59,7

OVEN COLUMNS H 111



Le colonne non sono comprensive di top - N.B.: cassetti e cestoni ad estrazione totale con blumotion The columns do not include the tops - Note: fully extending drawers and deep drawers with blumotion system		COD.	MELA-MINICO	POLIMERICO		LACCATO			GLAKS	
			K26	OPACO K27	LUCIDO K27	A K28	B K28	PELTRO K28	K30	
 <p>colonna H 111 per forno 2 cassetti H 18 oven column H 111 2 drawers H 18</p>	L 60	E6501660	284	283	290	288	303	335	362	
 <p>colonna H 111 per forno 1 cestone chiuso H 36 oven column H 111 1 full deep drawer H 36</p>	L 60	E6501600	231	240	246	244	253	270	288	
 <p>colonna H 111 per forno 1 cestone vetro H 36 oven column H 111 1 glass deep drawer H 36</p>										
		telaio petro-polimerico L 60 pewter-polymeric frame	E6501610	338	294	301	338	338	338	—
		telaio alluminio 419S L 60 aluminium frame	E6502610	319	319	319	319	319	319	—
 <p>top in laminato H 4 P 61 per colonne laminated top H 4 D 61 for columns</p>										
			VEDI	VEDI	VEDI	VEDI	VEDI	VEDI	VEDI	
		al ml per lm	T90135	LISTINO	LISTINO	LISTINO	LISTINO	LISTINO	LISTINO	LISTINO
 <p>kit protezione fianchi per forno protection kit sides for oven</p>	coppia couple		TOP	TOP	TOP	TOP	TOP	TOP	TOP	
		08630095	16	16	16	16	16	16	16	

COLONNE H 147 PER FORNO

P 59,7

OVEN COLUMNS H 147

Le colonne non sono comprensive di top - N.B.: cerniere ammortizzate di serie
 The columns do not include the tops - **Note: standard blumotion hinges**







	COD.	MELAMINICO	POLIMERICO		LACCATO			GLAKS	
		K26	OPACO K27	LUCIDO K27	A K28	B K28	PELTRO K28	K30	
 <p>colonna H 147 per forno 1 anta H 72 oven column H 147 1 door H 72</p>									
	L 60	E6520601/2	240	251	268	269	294	333	344
 <p>colonna H 147 per forno 4 cassetti H 18 oven column H 147 4 drawers H 18</p>									
	L 60	E6521610	441	439	454	449	479	544	596
 <p>colonna H 147 per forno 2 cassetti H 18 1 cestone H 36 oven column H 147 2 drawers H 18 1 deep drawer H 36</p>									
	L 60	E6521620	388	393	407	402	429	479	524
 <p>colonna H 147 per forno 2 cestoni H 36 oven column H 147 2 deep drawers H 36</p>									
	L 60	E6521630	338	350	363	358	383	417	454
 <p>colonna H 147 per forno per maxiforno H 48 1 cassetto H 18 2 ante H 60 oven column H 147 for maxi-oven H 48 1 drawer H 18 2 doors H 60</p>									
	L 90	E6521910	396	406	429	432	481	547	617
 <p>top in laminato H 4 P 61 per colonne laminated top H 4 D 61 for columns</p>									
			VEDI	VEDI	VEDI	VEDI	VEDI	VEDI	VEDI
	al ml per lm	T90135	LISTINO	LISTINO	LISTINO	LISTINO	LISTINO	LISTINO	LISTINO
		mag.griglia di areazione cad. surcharge for ventilation grille each	TOP	TOP	TOP	TOP	TOP	TOP	TOP

COLONNE PER FORNO H 219

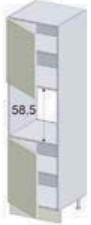
P 59,7

OVEN COLUMNS H 219

N.B.: cassetti e cestoni ad estrazione totale con blumotion
 Note: fully extending drawers and deep drawers with blumotion system



	COD.	MELA- MINICO	POLIMERICO		LACCATO			GLAKS	
		K26	OPACO K27	LUCIDO K27	A K28	B K28	PELTRO K28	K30	
 <p>colonna per forno 1 anta superiore H 72 1 anta inferiore H 72 oven column 1 upper door H 72 1 lower door H 72</p>	L 60	E6530601/2	351	385	408	410	459	538	560
	 <p>colonna per forno 1 anta H 72 4 cassetti H 18 oven column 1 door H 72 4 drawers H 18</p>	L 60	E6531611/2	569	584	610	606	659	763
 <p>colonna per forno 1 anta H 72 2 cassetti H 18 1 cestone H 36 oven column 1 door H 72 2 drawers H 18 1 deep drawer H 36</p>		L 60	E6531621/2	516	538	563	559	610	697
	 <p>colonna per forno 1 anta H 72 2 cestoni H 36 oven column 1 door H 72 2 deep drawers H 36</p>	L 60	E6531631/2	463	492	516	512	560	632
 <p>profilo in acciaio a "L" per rifinire il ripiano del forno e microonde L-shaped steel finishing profile for oven shelf and microwave</p>		L 60	08660100	9	9	9	9	9	9
	 <p>kit protezione fianchi per forno protection kit sides for oven</p>	coppia couple	08630095	16	16	16	16	16	16

COLONNE PER FORNO H 219

P 59,7

OVEN COLUMNS H 219

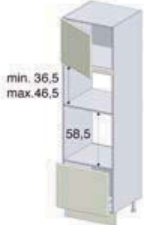
N.B.: cassetti e cestoni ad estrazione totale con blumotion
 Note: fully extending drawers and deep drawers with blumotion system

	COD.	MELAMINICO	POLIMERICO		LACCATO			GLAKS	
		K26	OPACO K27	LUCIDO K27	A K28	B K28	PELTRO K28	K30	
 <p>colonna per forno e micro 1 anta superiore H 48 vano micro da H 36,5 a 46,5 cestone H 48 oven and microwave column 1 upper door H 48 microwave compartment H 36,5 to 46,5 deep drawer H 48</p>	L 60	E6551601/2	425	444	464	460	501	568	625
 <p>colonna per forno 1 anta superiore H 48 1 anta H 48 sollevamento verticale 1 cestone H 48 oven column 1 upper door H 48 1 door H 48 vertical opening 1 deep drawer H 48</p>	L 60	E6554601/2	586	614	639	634	684	760	825
 <p>colonna per forno e lavastoviglie Rex TTC 1003 1 anta superiore H 48 anta lavastoviglie H 72 cassetto H 24 column for oven and REX TTC 1003 dishwasher 1 upper door H 48 dishwasher door H 72 drawer H 24</p>	L 60	E6573601/2	393	420	443	444	493	562	614

COLONNE PER FORNO H 243

P 59,7

OVEN COLUMNS H 243

N.B.: cassetti e cestoni ad estrazione totale con blumotion
 Note: fully extending drawers and deep drawers with blumotion system

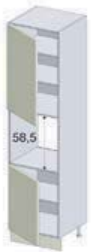
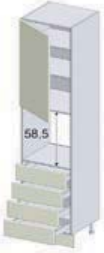
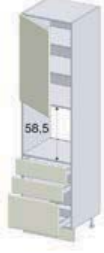
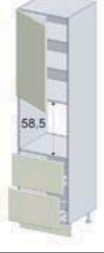
	COD.	MELA-MINICO	POLIMERICICO		LACCATO			GLAKS	
		K26	OPACO K27	LUCIDO K27	A K28	B K28	PELTRO K28	K30	
 <p>colonna per forno 1 anta superiore H 96 1 anta inferiore H 72 oven column 1 upper door H 96 1 lower door H 72</p>	L 60	E6540601/2	389	430	456	461	519	610	631
 <p>colonna per forno 1 anta H 96 4 cassetti H 18 oven column 1 door H 96 4 drawers H 18</p>	L 60	E6541611/2	606	626	656	655	716	832	894
 <p>colonna per forno 1 anta superiore H 96 2 cassetti H 18 1 cestone H 36 oven column 1 upper door H 96 2 drawers H 18 1 deep drawer H 36</p>	L 60	E6541621/2	553	581	609	608	667	767	821
 <p>colonna per forno 1 anta superiore H 96 2 cestoni H 36 oven column 1 upper door H 96 2 deep drawers H 36</p>	L 60	E6541631/2	500	535	562	561	617	702	748

COLONNE PER FORNO H 243

P 59,7

OVEN COLUMNS H 243





N.B.: cassetti e cestoni ad estrazione totale con blumotion
 Note: fully extending drawers and deep drawers with blumotion system

	COD.	MELA-MINICO	POLIMERICO		LACCATO			GLAKS	
		K26	OPACO K27	LUCIDO K27	A K28	B K28	PELTRO K28	K30	
 <p>colonna per forno e micro 1 anta superiore H 72 vano micro da H 36,5 a 46,5 cestone H 48 oven and microwave column 1 upper door H 72 microwave compartment H 36,5 to 46,5 deep drawer H 48</p>	L 60	E6561601/2	447	473	497	495	544	626	672
 <p>colonna per forno 1 anta superiore H 72 1 anta H 48 sollevamento verticale 1 cestone H 48 oven column 1 upper door H 72 1 door H 48 vertical opening 1 deep drawer H 48</p>	L 60	E6564601/2	616	652	680	678	736	826	880
 <p>colonna per forno e lavastoviglie Rex TTC 1003 1 anta superiore H 72 anta lavastoviglie H 72 cassetto H 24 column for oven and REX TTC 1003 dishwasher 1 upper door H 72 dishwasher door H 72 drawer H 24</p>	L 60	E6575601/2	424	458	485	488	545	628	669
 <p>profilo in acciaio a "L" per rifinire il ripiano del forno e microonde L-shaped steel finishing profile for oven shelf and microwave</p> 	L 60	08660100	9	9	9	9	9	9	9
 <p>kit protezione fianchi per forno protection kit sides for oven</p> 	coppia couple	08630095	16	16	16	16	16	16	16

COLONNE PER FRIGO H 147 - 219

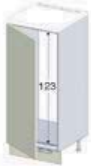
P 59,7

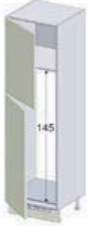
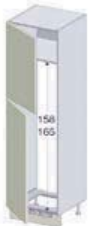

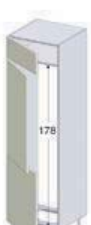
FRIDGE COLUMNS H 147 - 219

Le colonne non sono comprensive di top The columns do not include the tops		COD.	MELA-MINICO	POLIMERICO		LACCATO			GLAKS
			K26	OPACO K27	LUCIDO K27	A K28	B K28	PELTRO K28	K30
 <p>colonna H 147 per frigo 215 monoporta column H 147 for single-door fridge 215</p>	L 60	E6452151/2	264	299	320	329	375	449	462
		E6462151/2	354	397	431	451	524	642	667
 <p>colonna H 219 per frigo 215 monoporta 1 anta superiore H 72 1 anta inferiore H 132 column H 219 for 215 single-door fridge 1 upper door H 72 lower door H 132</p>	L 60	E6462151/2	354	397	431	451	524	642	667
		E6462311/2	354	397	431	451	524	642	667
 <p>colonna H219 per frigo-freezer 230 - 260 1 anta superiore H 84 1 anta inferiore H 120 column H 219 for 230 - 260 fridge-freezer 1 upper door H 84 1 lower door H 120</p>	L 60	E6462311/2	354	397	431	451	524	642	667
		E6462811/2	354	397	431	451	524	642	667
 <p>colonna H 219 per frigo-freezer 280 1 anta superiore H 84 1 anta inferiore H 120 column H 219 for 280 fridge-freezer 1 upper door H 84 1 lower door H 120</p>	L 60	E6462811/2	354	397	431	451	524	642	667
		E6462861/2	354	397	431	451	524	642	667
 <p>colonna H 219 per frigo-congelatore 315 2 ante anta superiore H 132 anta inferiore H 72 column H 219 for 315 fridge-freezer 2 doors upper door H 132 lower door H 72</p>	L 60	E6463151/2	354	397	431	451	524	642	667
		E6463161/2	354	397	431	451	524	642	667
 <p>colonna H 219 per frigo-congelatore 315 3 ante anta superiore H 24 anta centrale H 108 anta inferiore H 72 column H 219 for 315 fridge-freezer 3 doors upper door H 24 central door H 108 lower door H 72</p>	L 60	E6463161/2	354	397	431	451	524	642	667
		E6463161/2	354	397	431	451	524	642	667

COLONNE PER FRIGO H 219

P 59,7

FRIDGE COLUMNS H 219

	COD.	MELAMINICO	POLIMERICO		LACCATO			GLAKS
		K26	OPACO K27	LUCIDO K27	A K28	B K28	PELTRO K28	K30
 <p>colonna H 219 per frigo-congelatore 330 1 anta superiore H 132 1 anta inferiore H 72 column H 219 for 330 fridge-freezer 1 upper door H 132 1 lower door H 72</p>								
	L 60	E6463301/2	354	397	431	451	524	642
 <p>colonna H 219 per frigo-freezer 300 monoporta 1 anta H 204 (anta unita 132+72 nelle finiture legno per la versione polimerico) column H 219 for 300 single-door fridge-freezer 1 door H 204 (joint doors 132+72 for wooden finishes of polymeric version)</p>								
	L 60	E6463001/2	354	397	431	451	524	642

COLONNE PER FRIGO H 243

FRIDGE COLUMNS H 243

P 59,7

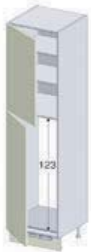
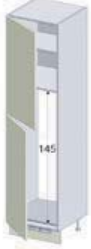
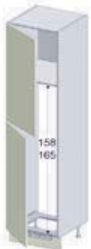
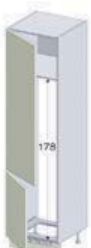
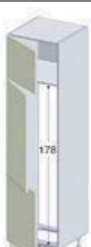
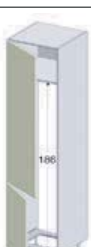
	COD.	MELA-MINICO	POLIMERICICO		LACCATO			GLAKS	
		K26	OPACO K27	LUCIDO K27	A K28	B K28	PELTRO K28	K30	
 <p>colonna H 243 per frigo 215 monoporta 1 anta superiore H 96 1 anta inferiore H 132 column H 243 for 215 single-door fridge 1 upper door H 96 1 lower door H 132</p>	L 60	E6472151/2	376	427	464	489	572	701	739
 <p>colonna H 243 per frigo-freezer 230 - 260 1 anta superiore H 108 1 anta inferiore H 120 column H 243 for 230 - 260 fridge-freezer 1 upper door H 108 1 lower door H 120</p>	L 60	E6472311/2	376	427	464	489	572	701	739
 <p>colonna H 243 per frigo-freezer 280 1 anta superiore H 108 1 anta inferiore H 120 column H 243 for 280 fridge-freezer 1 upper door H 108 1 lower door H 120</p>									
	Indesit Ariston								
	L 60 vano H 165 W 60 compartment H 165	E6472811/2	376	427	464	489	572	701	739
Candy e Rex									
L 60 vano H 158 W 60 compartment H 165	E6472861/2	376	427	464	489	572	701	739	
 <p>colonna H 243 per frigo-congelatore 315 2 ante 1 anta superiore H 156 (anta unita 132+24 nelle finiture legno per la versione polimerico) 1 anta inferiore H 72 column H 243 for 315 fridge-freezer 2 doors 1 upper door H 156 (joint doors 132+24 for wooden finishes of polymeric version) 1 lower door H 72</p>	L 60	E6473151/2	376	427	464	489	572	701	739
 <p>colonna H 243 per frigo-congelatore 315 3 ante 1 anta superiore H 48 1 anta centrale H 108 1 anta inferiore H 72 column H 243 for 315 fridge-freezer 3 doors 1 upper door H 48 1 central door H 108 1 lower door H 72</p>	L 60	E6473161/2	376	427	464	489	572	701	739
 <p>colonna H 243 per frigo-congelatore 330 2 ante 1 anta superiore H 156 (anta unita 132+24 nelle finiture legno per la versione polimerico) 1 anta inferiore H 72 column H 243 for 330 fridge-freezer 2 doors 1 upper door H 156 (joint doors 132+24 for wooden finishes of polymeric version) 1 lower door H 72</p>	L 60	E6473301/2	376	427	464	489	572	701	739

COLONNE PER FRIGO H 243

P 59,7

FRIDGE COLUMNS H 243

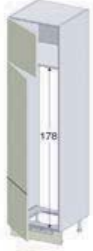
	COD.	MELA-MINICO	POLIMERICO		LACCATO			GLAKS
		K26	OPACO K27	LUCIDO K27	A K28	B K28	PELTRO K28	K30
 <p>colonna H 243 per frigo-congelatore 300 monoporta 1 anta superiore H 48 1 anta inferiore H 180 (anta unita 108+72 nelle finiture legno per la versione polimerico) column H 243 for 300 single-door fridge-freezer 1 upper door H 48 1 lower door H 180 (joint doors 108+72 for wooden finishes of polymeric version)</p>								
	L 60	E6473001/2	376	427	464	489	572	701

TERMINALI A GIORNO OPEN END UNITS



colori disponibili per elementi a giorno laccati opaco soft
colours available for soft matt lacquered open units

bianco assoluto opaco (opz.740S) matt absolute white	cenere opaco (opz.9547) matt ash	verde provenza opaco (opz.8465) matt provence green	titanio opaco (opz.9545) matt titanium	cappuccino opaco (opz.7771) matt cappuccino	caffè opaco (opz.887S) matt coffee	verde lichene opaco (opz.8463) matt green lichen
rosa quarzo opaco (opz.8181) matt quartz pink	lavanda opaco (opz.9141) matt lavender	blu laguna opaco (opz.8365) matt lagoon blue	avorio opaco (opz.767S) matt ivory	rosso opaco (opz.125S) matt red	rubino opaco (opz.8151) matt ruby	lavagna opaco (opz.9543) matt slate grey
lime opaco (opz.8461) matt lime	giallo ambra opaco (opz.327S) matt amber yellow	oro vecchio opaco (opz.933S) matt old gold	mandarino opaco (opz.8155) matt mandarin	blu oltremare opaco (opz.922S) matt ultramarine	prugna opaco (opz.8631) matt plum	grigio perla opaco (opz.9555) matt pearl grey
grigio argento opaco (opz.9541) matt silver grey	lilla opaco (opz.392S) matt lilac	glicine opaco (opz.920S) matt wisteria	blu aviazione opaco (opz.8363) matt aviation blue	nero assoluto opaco (opz.786S) matt absolute black		

laccato peltro
pewter lacquered



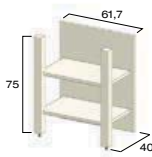
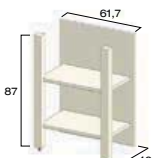
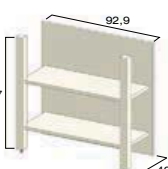
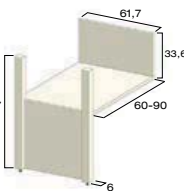
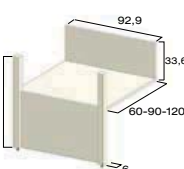

TERMINALI A GIORNO LACCATI PER ISOLA E PENISOLA

LACQUERED ISLAND AND PENINSULA OPEN END UNITS

	COD.	MELAMINICO	POLIMERICO		LACCATO			GLAKS	
		K26	OPACO K27	LUCIDO K27	LUCIDO K28	OPACO K28	PELTRO K28	K30	
<p>terminale a giorno laccato come anta per isola ribassata lacquered open end unit same as door for lowered island</p> 	L 61,7 H 75 P 40	ETB00510	—	—	—	—	438	552	—
<p>terminale a giorno laccato come anta lacquered open end unit same as door</p> 	L 61,7 H 87 P 40	ETB00610	—	—	—	—	451	566	—
<p>terminale a giorno laccato come anta lacquered open end unit same as door</p> 	L 92,9 H 87 P 40	ETB00630	—	—	—	—	487	638	—
<p>terminale a giorno laccato come anta da inserire in appoggio con base H 51 lacquered open end unit same as door to be inserted in support with base unit H 51</p> 	L 61,7 H 87 P 66 L 61,7 H 87 P 96	ETB00711 ETB00713	—	—	—	—	343 390	425 448	—
<p>terminale a giorno laccato come anta da inserire in appoggio con base H 51 lacquered open end unit same as door to be inserted in support with base unit H 51</p> 	L 92,9 H 87 P 66 L 92,9 H 87 P 96 L 92,9 H 87 P 126	ETB00731 ETB00733 ETB00735	—	—	—	—	452 520 602	575 601 637	—

FIANCHI DI FINITURA E COPRIFIANCHI LACCATI

FINISHING AND LACQUERED SIDE PANELS

	COD.	MELA-MINICO	POLIMERICO		LACCATO			GLAKS		
		K26	OPACO K27	LUCIDO K27	A K28	B K28	PELTRO K28	K30		
<p>maggiorazione per fianchi di struttura come anta (cadauno)</p> <p>N.B.: finiture legno venature verticali surcharge for carcass sides same finish as door (each)</p> <p>Note: wooden finishes vertical grains</p> 										
	PENSILE WALL UNIT									
	36x31	+24	+20	+24	-	-	-	+67		
	48x31	+26	+23	+28	-	-	-	+75		
	60x31	+29	+26	+31	-	-	-	+80		
	72x31	+34	+29	+36	-	-	-	+88		
	96x31	+40	+35	+44	-	-	-	+99		
	120x31	+42	+41	+54	-	-	-	+132		
	132x31	+45	+44	+56	-	-	-	+136		
	BASE ZOCCOLO H 15 BASE UNIT - PLINTH H 15									
	36x48	+30	+28	+48	-	-	-	+86		
	48x48	+33	+33	+58	-	-	-	+103		
	36x57,5	+30	+28	+48	-	-	-	+86		
	48x57,5	+33	+33	+58	-	-	-	+103		
	60x57,5	+36	+38	+64	-	-	-	+118		
	72x57,5	+39	+44	+69	-	-	-	+126		
	COLONNA ZOCCOLO H 15 COLUMN - PLINTH H 15									
	132x31	+45	+44	+56	-	-	-	+136		
	204x31	+55	+72	+90	-	-	-	+214		
	228x31	+63	+81	+100	-	-	-	+241		
	96x57,5	+44	+52	+77	-	-	-	+165		
	132x57,5	+52	+89	+89	-	-	-	+214		
	204x57,5	+64	+104	+133	-	-	-	+342		
	228x57,5	+67	+115	+145	-	-	-	+355		
	<p>Coprifianco LACCATO sp.1 mm per rifinire i fianchi a vista LACQUERED side panel th. 1 mm for visible sides finishing</p> 									
		PENSILE WALL UNIT								
		36x31	T98340	-	-	-	47	47	59	-
		48x31	T98345	-	-	-	48	48	61	-
		60x31	T98350	-	-	-	50	50	63	-
		72x31	T98355	-	-	-	52	52	66	-
		96x31	T98360	-	-	-	65	65	85	-
		120x31	T98365	-	-	-	71	71	104	-
		132x31	T98367	-	-	-	98	98	113	-
BASE BASE UNIT										
36x57,5		T98300	-	-	-	50	50	82	-	
48x57,5		T98305	-	-	-	62	62	98	-	
60x57,5		T98310	-	-	-	66	66	103	-	
72x57,5	T98315	-	-	-	71	71	113	-		
COLONNA COLUMN										
132x31	T98367	-	-	-	98	98	113	-		
204x31	T98375	-	-	-	130	130	174	-		
228x31	T98380	-	-	-	132	132	195	-		
96x57,5	T98320	-	-	-	92	92	148	-		
132x57,5	T98325	-	-	-	136	136	200	-		
204x57,5	T98330	-	-	-	201	201	304	-		
228x57,5	T98335	-	-	-	227	227	339	-		

ANTE DI FINITURA LATERALI E POSTERIORI

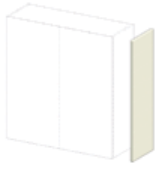
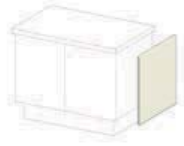
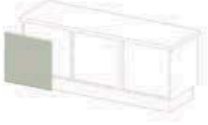

LATERAL AND REAR FINISHING DOORS

* Per il codice sostituire le XXX con il codice della versione corrispondente
 * Replace XXX with the concerning code version

	* COD.	MELA-MINICO	POLIMERICO		LACCATO			GLAKS
		K26	OPACO K27	LUCIDO K27	A K28	B K28	PELTRO K28	K30
<p>ante di finitura laterali sp. 2 N.B.: finiture legno venature verticali lateral finishing doors th. 2 Note: wooden finishes vertical grains</p> 								
PENSILE WALL UNIT								
H 36 - 35,7x33,2	1XXX4045	44	32	36	36	45	59	82
H 48 - 47,7x33,2	1XXX4046	44	37	42	39	48	62	102
H 60 - 59,7x33,2	1XXX4047	44	42	48	45	57	74	109
H 72 - 71,7x33,2	1XXX405	44	46	54	51	66	87	123
H 96 - 95,7x33,2	1XXX406	50	56	65	65	84	112	131
H 120 - 119,7x33,2	1XXX407	64	71	84	86	112	150	171
H 132 - 131,7x33,2	1XXX408	64	71	84	86	112	150	206
<p>ante di finitura laterali sp. 2 N.B.: finiture legno venature verticali lateral finishing doors th. 2 Note: wooden finishes vertical grains</p> 								
BASE ZOCCOLO H 15 BASE UNIT - PLINTH H 15								
H 51 - 35,7x59,6	1XXX395	41	45	52	50	64	82	104
H 63 - 47,7x59,6	1XXX396	46	54	63	63	81	107	124
H 75 - 59,7x59,6	1XXX398	52	62	73	76	103	130	164
H 87 - 71,7x59,6	1XXX400	55	70	82	90	119	152	194
ISOLA ZOCCOLO H 15 ISLAND - PLINTH H 15								
H 75 - 59,7x61,7	1XXX402	58	64	74	78	102	133	164
H 87 - 71,7x61,7	1XXX403	62	72	85	90	118	157	194
COLONNA ZOCCOLO H 15 COLUMN - PLINTH H 15								
H 111 - 95,7x59,6	1XXX409	58	110	139	98	130	180	189
H 147 - 131,7x59,6	1XXX410	70	153	191	130	174	243	255
H 219 - 203,7x59,6	1XXX411	98	225	283	202	271	371	405
H 243 - 227,7x59,6	1XXX412	110	244	309	226	332	419	417
<p>ante di finitura posteriori per basi uso penisola-isola sp.2 rear finishing doors th. 2 for base units used as peninsula-island</p> 								
BASE ZOCCOLO H 15 BASE UNIT - PLINTH H 15								
L 45 - 59,7x44,6	1XXX424	54	61	70	71	88	110	136
L 60 - 59,7x59,6	1XXX426	61	72	83	76	103	130	158
L 90 - 59,7x89,6	1XXX428	75	94	109	117	151	199	212
L 30 - 71,7x29,6	1XXX430	53	55	62	61	75	91	117
L 40 - 71,7x39,6	1XXX432	60	63	72	73	92	115	139
L 45 - 71,7x44,6	1XXX434	62	68	77	79	100	127	150
L 60 - 71,7x59,6	1XXX436	71	80	93	100	129	162	177
L 90 - 71,7x89,6	1XXX440	94	98	106	137	177	235	243
BASE ANGOLO ZOCCOLO H 15 CORNER BASE UNIT - PLINTH H 15								
L 65 - 71,7x64,6	1XXX438	70	85	98	103	133	173	204

FIANCONI D'ACCOSTO LACCATI

LACQUERED SIDE PANELS

	COD.	MELA-MINICO	POLIMERICO		LACCATO			GLAKS	
		K26	OPACO K27	LUCIDO K27	LUCIDO K28	OPACO K28	PELTRO K28	K30	
<p>fianconi sp.6 laccati come anta con profili laterali a sezione quadra N.B.: da utilizzare solo a fine composizione lacquered side panels th.6 same as door with square side profiles Note: use only at the end of composition</p> 									
	BASE BASE UNIT								
	75x59,7	1K284801/2	—	—	—	—	223	271	—
	87x59,7	1K284811/2	—	—	—	—	252	298	—
	PENISOLA PENINSULA								
	87x61,7	1K284821/2	—	—	—	—	256	298	—
	ISOLA ISLAND								
	87x92,9	1K284831/2	—	—	—	—	327	403	—
	COLONNA COLUMN								
	111x59,7	1K284851/2	—	—	—	—	316	379	—
	147x59,7	1K284861/2	—	—	—	—	400	504	—
<p>fianconi sp.6 laccati come anta con profili laterali a sezione quadra N.B.: da utilizzare solo a fine composizione lacquered side panels th.6 same as door with square side profiles Note: use only at the end of composition</p> 									
	COLONNA COLUMN								
	219x59,7	1K284871/2	—	—	—	—	559	702	—
243x59,7	1K284881/2	—	—	—	—	620	734	—	

PANNELLI DI FINITURA

FINISHING PANELS

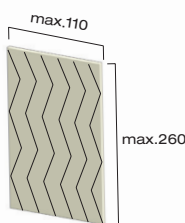
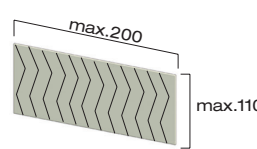
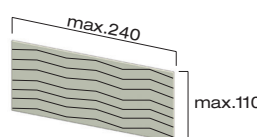
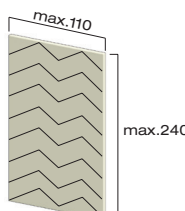
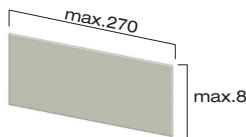
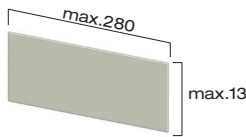
	COD.	MELAMINICO	POLIMERICICO		LACCATO			GLAKS
		K26	OPACO K27	LUCIDO K27	A K28	B K28	PELTRO K28	K30
 <p>pannello di finitura come anta melaminico con venatura verticale 4 lati squadrati e bordati N.B.: quantità minima fatturabile 1 mq finishing panel same as melamine door with vertical grain 4 sides squared and rimmed Note: minimum invoiceable quantity 1 m²</p>								
sp.2 al mq th.2 per m ²	094505	140	—	—	—	—	—	—
 <p>pannello di finitura come anta melaminico con venatura verticale 4 lati squadrati e bordati N.B.: quantità minima fatturabile 1 mq finishing panel same as melamine door with vertical grain 4 sides squared and rimmed Note: minimum invoiceable quantity 1 m²</p>								
sp.2 al mq th.2 per m ²	094505R	140	—	—	—	—	—	—
 <p>pannello di finitura come anta polimerico con venatura orizzontale (escluso rovere cenere) interno colore bianco N.B.: quantità minima fatturabile 0,5 mq finishing panel same as polymeric door with horizontal grain (except ash oak) interior white Note: minimum invoiceable quantity 0,5 m²</p>								
sp.2 al mq th.2 per m ²	0945645	—	323	385	—	—	—	—
 <p>pannello di finitura polimerico con venatura orizzontale rovere cenere interno colore bianco N.B.: quantità minima fatturabile 0,5 mq polymeric finishing panel with horizontal grain for ash oak door interior white Note: minimum invoiceable quantity 0,5 m²</p>								
sp.2 al mq th.2 per m ²	0945646	—	323	—	—	—	—	—
 <p>pannello di finitura laccato come anta N.B.: quantità minima fatturabile 0,5 mq lacquered finishing panel same as door Note: minimum invoiceable quantity 0,5 m²</p>								
sp.2 al mq th.2 per m ²	094531	—	—	—	231	231	423	—
 <p>pannello di finitura come anta glaks N.B.: quantità minima fatturabile 0,5 mq finishing panel same as glaks door Note: minimum invoiceable quantity 0,5 m²</p>								
sp.2 al mq th.2 per m ²	094590	—	—	—	—	—	—	357

kyra NECK

anta con maniglia a gola
door with finger-rail handle

Il modello KYRA NECK si differenzia per il sistema a gola che permette di ottenere linee forti ed essenziali.

Le particolari finiture Lucido, Bianco Semilucido e Brown Opaco della gola, sono abbinabili a una qualsiasi delle nuove ante che caratterizzano il modello Kyra.

Molte le possibilità di scelta di finiture e colori per abbinamenti moderni e ricercati: tutte le ante sono lisce e dello spessore di 20 mm e si possono avere nelle nuove finiture TSS (Tecno Structure Surface) Sincro Poro fiamma verticale, nell'esclusivo Sincro Poro effetto Vintage a fiamma verticale, nell'aristocratico effetto vetro lucido e opaco, nel pratico MDF rivestito in Polimerico nei colori tinta unita lucidi o opachi e nei colori legno lucidi e opachi e nel prestigioso MDF Laccato fronte e bordi lucido e opaco che, oltre ai nuovi colori Fango, Bianco Caldo e all'esclusivo Peltro, viene proposto a campione nei colori della vasta gamma RAL. I mille dettagli e le molteplici possibilità compositive fanno di Kyra Neck un modello tipico della produzione Creo Kitchens.





CREO ECOLOGIC

IL GRUPPO LUBE HA SCELTO DI UTILIZZARE PER I COMPONENTI COSTITUENTI LE STRUTTURE DELLE CUCINE SOLO MATERIALE A BASSISSIMA EMISSIONE DI FORMALDEIDE: CONFORMI ALLO STANDARD F4STELLE SECONDO LA NORMA JIS, CERTIFICATO DAL MINISTERO GIAPPONESE, IL PIU' SEVERO IN MERITO ALLE NORMATIVE DI SALVAGUARDIA AMBIENTALE.

Regarding the production of its kitchen structure components, lube group has decided to only use materials featuring very low formaldehyde emissions complying with the 4-star standard, as defined by the jis regulation. This standard is certified by the Japanese government-the most rigorous when it comes to environmental protection.

The KYRA NECK model differs for the finger rail system that allows to have strong and basic design lines. The unique rail system finishes in the Gloss, Semi-Gloss White and Matt Brown colors, can be combined with any of the new doors characterizing the model Kyra.

There are many choices of finishes and colors for modern and sophisticated combinations: all doors are smooth with 20 mm of thickness, and available in the new TSS finishes (Surface Structure Technology) as in the vertical flame Synchro Pore, then in the exclusive Synchro Pore vintage effect with vertical flame, in the refined gloss and matt glass effect, in the practical MDF covered with Polymeric glossy and matt solid colors or glossy and matt wood colors, and finally in the prestigious lacquered MDF (glossy and matt front and edges), that in addition to the new colors Mud, Warm White and to the exclusive Pewter, is proposed to sample RAL wide range of colors.







Thanks to the many details and configuration solutions, Kyra can be defined as a typical model of Creo Kitchens production.

CREOKITCHENS®

KYRA NECK 125



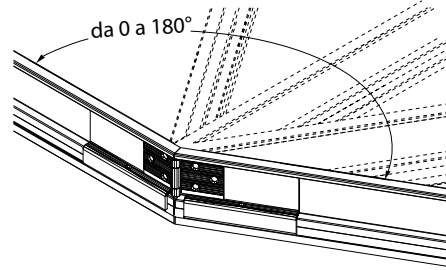



GOLA ORIZZONTALE SOTTOTOP

UNDERMOUNT HORIZONTAL FINGER RAIL

	COD.	€		COD.	€
<p>gola sottotop tipo "A" N.B.: costo già compreso nel prezzo delle basi type "A" undermount finger rail Note: cost already included in base unit price</p>  <p style="text-align: right;">al ml per lm</p>	G950010	20	<p>angolo interno a 90° per gola tipo "A" N.B.: costo già compreso nel prezzo delle basi angolo 90° interior corner for "A" type finger rail Note: cost already included in corner unit price</p>  <p style="text-align: right;">cadauno each</p>	G950050	48
<p>terminale aperto dx o sx per gola tipo "A" da utilizzare a fine composizione RH or LH open end for type "A" finger rail to be placed at the end of the composition</p>  <p style="text-align: right;">in plastica colore alluminio plastic aluminium colour</p> <p style="text-align: right;">terminale DX RH end G950041 8 terminale SX LH end G950042 8</p> <p style="text-align: right;">in alluminio colore bianco, brown, beige aluminium white, brown, beige colours</p> <p style="text-align: right;">terminale DX RH end G950021 23 terminale SX LH end G950022 23</p>			<p>angolare con snodo per unione fuori squadra per gola tipo "A" corner piece with joint for out-of-plumb joining for type "A" finger rail</p> 		
<p>terminale chiuso dx o sx per gola tipo "A" da utilizzare solo tra basi e colonne RH or LH closure for type "A" finger rail to be placed only between base units and column</p>  <p style="text-align: right;">in plastica colore alluminio plastic aluminium colour</p> <p style="text-align: right;">terminale DX RH end G950045 8 terminale SX LH end G950046 8</p> <p style="text-align: right;">in alluminio colore bianco, brown, beige aluminium white, brown, beige colours</p> <p style="text-align: right;">terminale DX RH end G950031 23 terminale SX LH end G950032 23</p>			<p>da 0 a 180°</p> 	G950060	57
			<p>finiture gole alluminio aluminium finger rails finishes</p>  <p style="text-align: center;"> alluminio lucido (opz.410) bianco semilucido (opz.001) polished aluminium (opt.410) semi-polished white (opt.001) </p> <p style="text-align: center;"> brown opaco (opz.370) beige semilucido (opz.444) matt brown (opt.370) semi-polished beige (opt.444) </p>		



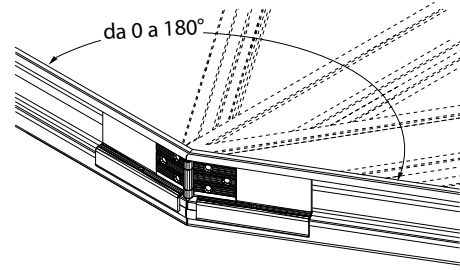



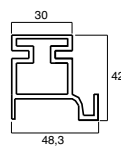

GOLA ORIZZONTALE INTERMEDIA

INTERMEDIATE HORIZONTAL FINGER RAIL

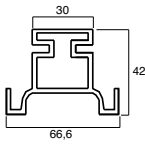
	COD.	€		COD.	€
<p>gola intermedia tipo "B" N.B.: costo già compreso nel prezzo delle basi con cassetti o cestoni type "B" intermediate finger rail Note: cost already included in price base unit with drawers or deep drawers</p>  <p style="text-align: right;">al ml per lm</p>	G950110	30	<p>angolo interno a 90° per gola tipo "B" 90° interior corner for "B" type finger rail</p>  <p style="text-align: right;">cadauno each</p>	G950150	48
<p>terminale aperto dx o sx per gola tipo "B" da utilizzare a fine composizione RH or LH open end for type "B" finger rail to be placed at the end of the composition</p>  <p>in plastica colore alluminio plastic aluminium colour</p> <p>terminale DX RH end G950141 8 terminale SX LH end G950142 8</p> <p>in alluminio colore bianco, brown, beige aluminium white, brown, beige colours</p> <p>terminale DX RH end G950121 28 terminale SX LH end G950122 28</p>			<p>angolare con snodo per unione fuori squadra per gola tipo "B" corner piece with joint for out-of-plumb joining for type "B" finger rail</p> 		
<p>terminale chiuso dx o sx per gola tipo "B" da utilizzare solo tra cassettiere e lavastoviglie/colonne RH or LH closure for type "B" finger rail to be placed only between drawer units and dishwasher/columns</p>  <p>in plastica colore alluminio plastic aluminium colour</p> <p>terminale DX RH end G950145 8 terminale SX LH end G950146 8</p> <p>in alluminio colore bianco, brown, beige aluminium white, brown, beige colours</p> <p>terminale DX RH end G950131 28 terminale SX LH end G950132 28</p>				G950060	57
			<p>finiture gole alluminio aluminium finger rails finishes</p>  <p>alluminio lucido (opz.410) bianco semilucido (opz.001) polished aluminium (opt.410) semi-polished white (opt.001)</p> <p>brown opaco (opz.370) beige semilucido (opz.444) matt brown (opt.370) semi-polished beige (opt.444)</p>		

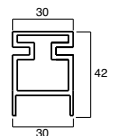
GOLE VERTICALI PER COLONNE

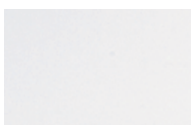
VERTICAL FINGER RAILS FOR COLUMNS

	COD.	€		COD.	€
<p>mezza gola verticale tipo "C" (completa di distanziale) type "C" half vertical finger rail (complete with spacer)</p>   <p>sezione mezza gola tipo "C" cross section of type "C" finger rail</p>	H 96	G950310	56		
	H 132	G950330	73		
	H 204	G950350	108		
	H 228	G950370	116		
<p>gola verticale intermedia tipo "D" (completa di distanziale) type "D" intermediate vertical finger rail (complete with spacer)</p>   <p>sezione gola tipo "D" cross section of type "D" finger rail</p>	H 96	G950410	56		
	H 132	G950430	73		
	H 204	G950450	108		
	H 228	G950470	116		
<p>gola verticale laterale tipo "E" (completa di distanziale) type "E" lateral vertical finger rail (complete with spacer)</p>   <p>sezione gola tipo "E" cross section of type "E" finger rail</p>	H 96	G950510	56		
	H 132	G950530	73		
	H 204	G950550	108		
	H 228	G950570	116		
<p>finiture gole alluminio aluminium finger rails finishes</p>   <p>alluminio lucido (opz.410) polished aluminium (opt.410)</p> <p>bianco semilucido (opz.001) semi-polished white (opt.001)</p>   <p>brown opaco (opz.370) matt brown (opt.370)</p> <p>beige semilucido (opz.444) semi-polished beige (opt.444)</p>					



NOZIONI UTILI - gole orizzontali per basi

USEFUL INFORMATIONS - HORIZONTAL FINGER RAILS FOR BASE UNITS

VISTA FRONTALE

FRONT VIEW

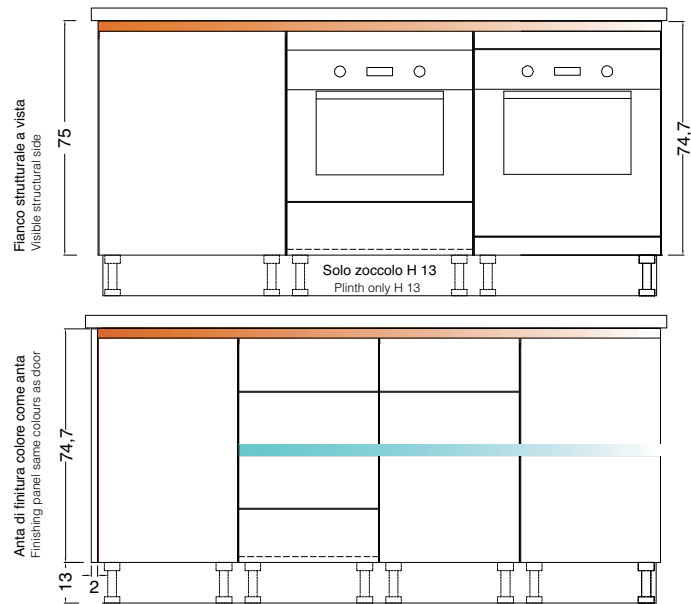

VISTA LATERALE (sezione)

SIDE VIEW (CROSS SECTION)

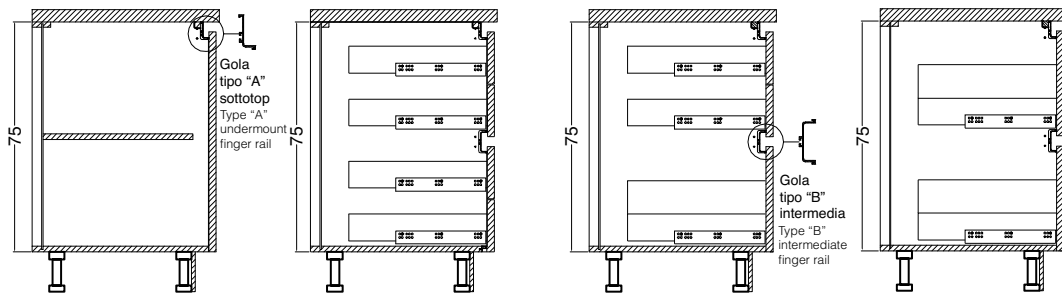

VISTA DALL'ALTO

TOP VIEW

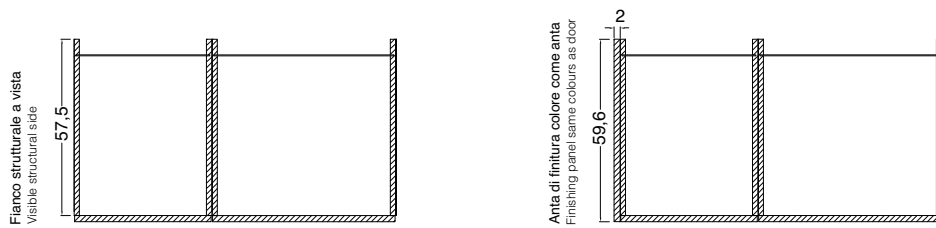

Composizione con ante di finitura laterali: alla dimensione finale della cucina, sommare sempre lo spessore delle ante di finitura (ogni anta 2 cm)

Composition with side finishing panels: to the final size of the kitchen, always add the thickness of the finishing panels (each panel 20 mm)

NOZIONI UTILI - gole verticali per colonne H 109-145-217-241

USEFUL INFORMATIONS - VERTICAL FINGER RAILS FOR COLUMNS H 109-145-217-241

VISTA FRONTALE

FRONT VIEW

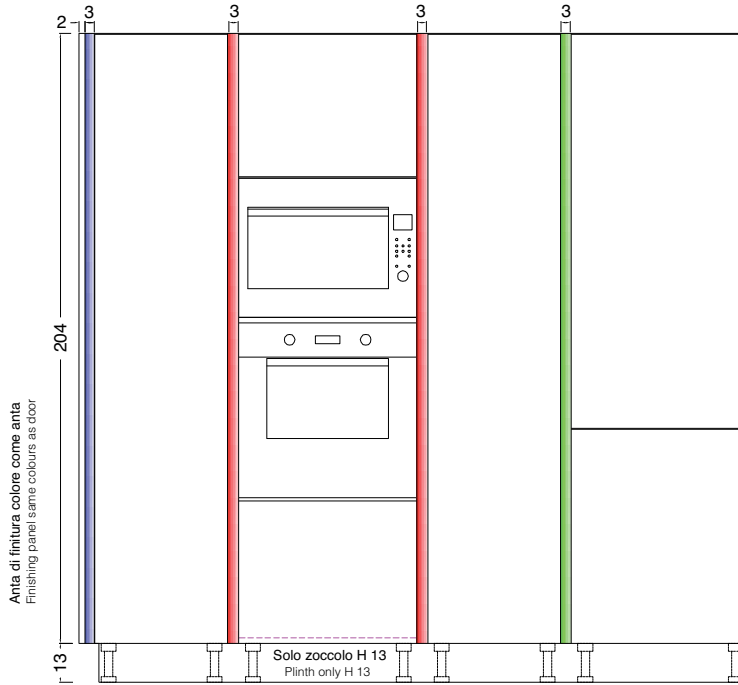

VISTA DALL'ALTO

TOP VIEW

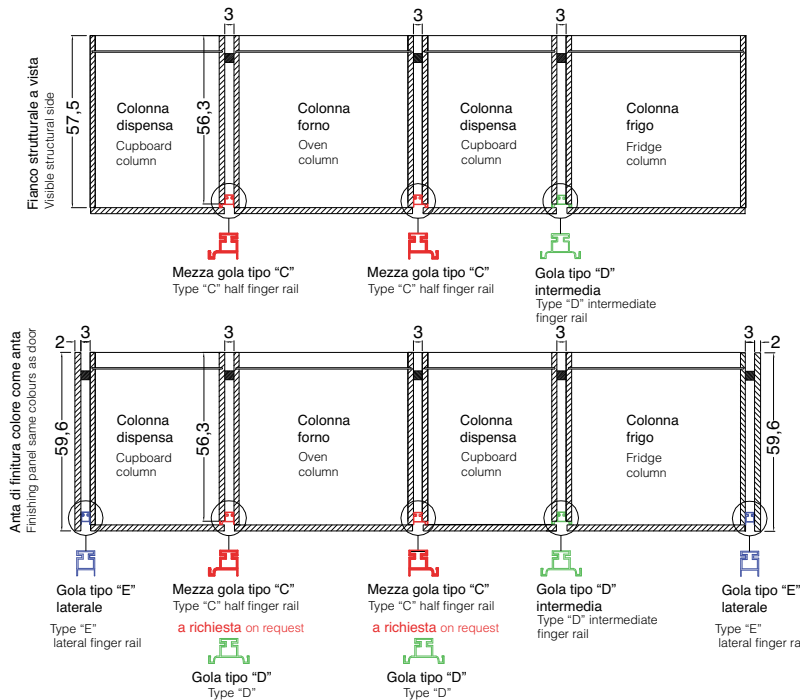

Composizione fianco strutturale a vista come anta: alla dimensione finale della cucina, sommare sempre lo spessore dei distanziali tra le colonne (ogni distanziale 3 cm)

Composition with visible side panel to match door: to the final size of the kitchen, always add the thickness of the spacers between the two columns (each spacer 3 cm)

Composizione con ante di finitura laterali, alla dimensione finale della cucina, sommare sempre lo spessore dei distanziali tra le colonne (ogni distanziale 3 cm) e lo spessore delle ante di finitura (ogni anta 2 cm)

Composition with side finishing panels to the final size of the kitchen, always add the thickness of the spacer between the two columns (each spacer 3 cm) and the thickness of the finishing panels (each panel 20 mm)

CARATTERISTICHE TECNICHE

ANTE E FRONTALI CASSETTI

pannello TSS (thermo-structured-surface) sp.20 mm con fiamma verticale sincro poro nei colori opachi:
rovere bianco spazzolato (opz.5311), rovere cipria spazzolato (opz.5312)

in melaminico sp.20 mm con fiamma verticale sincro poro effetto vintage nei colori opachi:
abete nordico bianco (opz.4406), abete nordico terra (opz.4407), rovere naturale vintage (opz.5310)

ANTE VETRO

di serie: telaio in alluminio finitura brill sp.20 mm, vetro satinato sp.4 mm

a richiesta: telaio in mdf laccato peltro sp mm 20, vetro retinato sp.6 mm

GOLA

di serie: **alluminio lucido (opz.410)**

a richiesta: alluminio finitura bianco semilucido (opz.001)
alluminio finitura beige semilucido (opz.444)
alluminio finitura brown opaco (opz.370)

STRUTTURE

ANTA: ROVERE BIANCO SPAZZOLATO
nobilitato bianco (opz.001), schiena e ripiano bianco (opz.001)

ANTE: ROVERE CIPRIA SPAZZOLATO, ABETE NORDICO TERRA
nobilitato perla d'oriente (opz.940), schiena e ripiano avorio (opz.930)

ANTE: ABETE NORDICO BIANCO, ROVERE NATURALE VINTAGE
nobilitato visone (opz.948M) schiena e ripiano bianco (opz.001)



MENSOLE

di serie: altezza 3,8 cm in laminato bianco (opz.001), perla d'oriente (opz.940), visone (opz.948M)

a richiesta: altezza 3,8 cm in melaminico rovere bianco spazzolato (opz.5311), rovere cipria spazzolato (opz.5312), abete nordico bianco (opz.4406), abete nordico terra (opz.4407), rovere naturale vintage (opz.5310)

ZOCCOLI

di serie: altezza 13 cm in pvc ricoperti in melamina finitura acciaio (opz.407)

a richiesta: altezza 13 cm in pvc ricoperti in melamina colore alluminio satinato (opz.405)
altezza 13 cm in pvc ricoperti in melamina bianco (opz.001)

altezza 13 cm in alluminio finitura brill (opz.412), bianco semilucido (opz.A001), **vedi maggiorazioni pag.156**
altezza 13 cm in pvc laccato peltro (opz.L9549), **vedi maggiorazioni pag.156**

TECHNICAL SPECIFICATIONS

DOORS AND DRAWERS FRONTS

TSS (thermo-structured surface) panel, Th. 20 mm, with vertical grain sync pore in the following matt colours:
brushed white oak (opt.5311), brushed powder oak (opt.5312)

melamine-faced panel, Th. 20 mm, with vertical grain sync pore vintage effect in the following matt colours:
white nordic fir (opt.4406), earth nordic fir (opt.4407), vintage natural oak (opt.5310)

GLASS DOORS

standard: Th. 20 mm aluminium frame, brill finish. Satin glass th. 4 mm.

on request: pewter lacquered MDF frame Th. 20 mm, with 6 mm thick wired glass

FINGER RAIL

standard: polished aluminium (opt.410)

on request: aluminium with semi-polished white finish (opt.001)
aluminium with semi-polished beige finish (opt.444)
aluminium with matt brown finish (opt.370)

CARCASSES

DOOR: BRUSHED WHITE OAK
melamine-coated white (opt.001), white back panel and shelf (opt.001)

DOORS: BRUSHED POWDER OAK, EARTH NORDIC FIR
melamine-faced oriental pearl (opt.940), ivory (opt.930) back panel and shelf

DOORS: WHITE NORDIC FIR, VINTAGE NATURAL OAK
melamine-faced mink (opt.948M), white (opt.001) back panel and shelf

SHELVES

standard: height 3.8 cm, laminate in the colours white (opt.001), oriental pearl (opt.940), mink (opt.948M)

on request: height 3.8 cm melamine-faced, brushed white oak (opt.5311), brushed powder oak (opt.5312), white nordic fir (opt.4406), earth nordic fir (opt.4407), vintage natural oak (opt.5310)

PLINTHS

standard: height 13 cm, melamine-faced pvc with steel finish (opt.407)

on request: height 13 cm, melamine-faced pvc with satin aluminium finish (opt.405)
height 13 cm, white melamine-faced pvc (opt.001)
height 13 cm, aluminium with brill finish (opt.412), semi-glossy white (opt.A001), [see surcharges on page 156](#)
height 13 cm, pewter lacquered pvc (opt.L9549), [see surcharges on page 156](#)



kyra melamine melamine

NECK

cod. **KG6**

ante opache TSS finitura sincro poro
TSS matt doors with sync pore finish

anta vetro telaio alluminio brill
glass door with brill aluminium frame

 *colori in pronta consegna*
available colours



rovere bianco spazzolato
(opz.5311)
brushed white oak
(opt.5311)



rovere cipria spazzolato
(opz.5312)
brushed powder oak
(opt.5312)

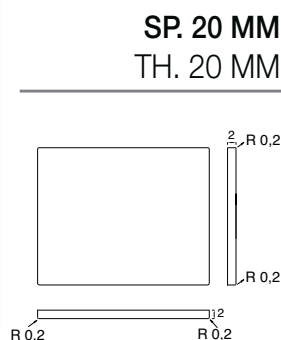

anta telaio alluminio brill,
vetro satinato (opz.419S)
door with aluminium frame brill finish
satin glass (opt.419S)

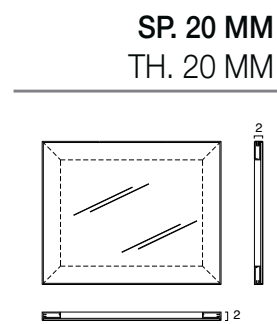

ante opache finitura sincro poro effetto vintage
matt doors with sync pore finish vintage effect

anta vetro effetto vintage **NEW**
vintage effect glass door



abete nordico bianco
(opz.4406)
white nordic fir (opt.4406)



abete nordico terra
(opz.4407)
earth nordic fir (opt.4407)



rovere naturale vintage
(opz.5310)
vintage natural oak (opt.5310)



telaio in mdf laccato peltro,
vetro retinato (opz.9549)
mdf frame with pewter finish,
wired glass (opt.9549)

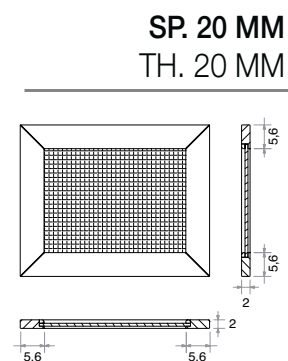

CARATTERISTICHE TECNICHE

ANTE E FRONTALI CASSETTI

in mdf rivestito in polimerico tinta unita finitura opaca sp mm 20 con interno melaminico bianco opaco, nei colori: bianco assoluto (opz.740P), tortora scuro (opz.8981), kaschmir (opz.7713), grigio seta (opz.9605), grafite (opz.9619), blu petrolio (opz.8325), verde lichene (opz.8441), grigio polvere (opz.9617), melanzana (opz.270P)

in mdf rivestito in polimerico effetto legno finitura opaca venatura orizzontale sp mm 20 con interno melaminico bianco opaco nei colori: olmo cotto (opz.5072), larice bianco sfumato grigio (opz.295P), noce chiaro (opz.238P), noce grigio (opz.239P), tranchè rovere champagne (opz.5273), tranchè rovere visone (opz.5275), rovere cenere (opz.260P), rovere naturale (opz.5344), frassino white (opz.2411), frassino dakar (opz.2412), frassino stone grey (opz.2413)

in mdf rivestito in polimerico tinta unita finitura lucida sp mm 20 con interno melaminico bianco opaco, nei colori: bianco assoluto (opz.741P), tortora scuro (opz.8982), beige (opz.7712), grigio vapore (opz.9608), antracite (opz.9602), senape (opz.8224), celeste alpaca (opz.8322), grigio ghiaia (opz.9612), melanzana (opz.271P)

in mdf rivestito in polimerico effetto legno finitura lucida venatura orizzontale sp mm 20 con interno melaminico bianco opaco, nei colori: larice grigio (opz.297P), larice bianco (opz.298P)

ANTE VETRO

di serie: telaio in mdf rivestito in polimerico finitura come anta sp mm 20, vetro satinato sp.4 mm

a richiesta: telaio in alluminio finitura brill sp.20 mm, vetro satinato sp.4 mm

GOLA

di serie: alluminio lucido (opz.410)

a richiesta: alluminio finitura bianco semilucido (opz.001)
alluminio finitura beige semilucido (opz.444)
alluminio finitura brown opaco (opz.370)

STRUTTURE

ANTE: BIANCO ASSOLUTO OPACO E LUCIDO, BLU PETROLIO OPACO, GRIGIO SETA OPACO, GRIGIO VAPORE LUCIDO, NOCE CHIARO, NOCE GRIGIO, LARICE BIANCO OPACO, GRIGIO POLVERE OPACO, CELESTE ALPACA LUCIDO, TRANCHÈ ROVERE CHAMPAGNE, FRASSINO WHITE, LARICE GRIGIO LUCIDO, LARICE BIANCO LUCIDO, MELANZANA OPACO E LUCIDO

nobilitato bianco (opz.001), schiena e ripiano bianco (opz.001)

ANTE: GRIGIO GHIAIA, TRANCHÈ ROVERE VISONE

nobilitato devalè finitura grafis (opz.796), schiena e ripiano bianco (opz.001)

ANTE: KASCHMIR OPACO, TORTORA SCURO OPACO E LUCIDO, SENAPE, BEIGE, FRASSINO DAKAR

nobilitato perla d'oriente (opz.940), schiena e ripiano avorio (opz.930)

ANTE: ROVERE CENERE, GRAFITE OPACO, ANTRACITE

nobilitato rovere cenere (opz.261) schiena e ripiano bianco (opz.001)

ANTA: OLMO COTTO

nobilitato larice moro (opz.218) schiena e ripiano bianco (opz.001)

ANTE: FRASSINO STONE GREY, ROVERE NATURALE, VERDE LICHENE OPACO

nobilitato visone (opz.948M) schiena e ripiano bianco (opz.001)



MENSOLE

di serie: altezza 3,8 cm in laminato bianco (opz.001), perla d'oriente (opz.940), devalè finitura grafis (opz.796), rovere cenere (opz.261), larice moro (opz.218), visone (opz.948M)

a richiesta: altezza 3,8 cm in polimerico per le finiture vedi colore ante

ZOCCOLI

di serie: altezza 13 cm in pvc ricoperti in melamina finitura acciaio (opz.407)

a richiesta: altezza 13 cm in pvc ricoperti in melamina colore alluminio satinato (opz.405)
altezza 13 cm in pvc ricoperti in melamina bianco (opz.001)
altezza 13 cm in alluminio finitura brill (opz.412), bianco semilucido (opz.A001),
vedi maggiori informazioni pag.156

TECHNICAL SPECIFICATIONS

DOORS AND DRAWERS FRONTS

solid colour polymer-coated MDF with matt finish, Th. 20 mm, with matt white melamine-faced interior, in the following colours: absolute white (opt.740P), dark dove grey (opt.8981), kashmir (opt.7713), silk grey (opt.9605), graphite (opt.9619), petroleum blue (opt.8325), lichen green (opt.8441), dust grey (opt.9617), aubergine (opt.270P)

polymer-coated MDF with wood effect, matt finish, horizontal grain, Th. 20 mm with matt white melamine-faced interior, in the following colours: burnt elm (opt.5072), white larch grey fading (opt.295P), light walnut (opt.238P), grey walnut (opt.239P), rough-hewn champagne oak (opt.5273), rough-hewn mink oak (opt.5275), ash oak (opt.260P), natural oak (opt.5344), white ash (opt.2411), dakar ash (opt.2412), stone grey ash (opt.2413)

polymer-coated MDF with glossy solid colour finish, Th. 20 mm, with matt white melamine-faced interior, in the following colours: absolute white (opt.741P), dark dove grey (opt.8982), beige (opt.7712), steam grey (opt.9608), anthracite (opt.9602), mustard (opt.8224), alpaca light blue (opt.8322), gravel grey (opt.9612), aubergine (opt.271P)

polymer-coated MDF with wood effect glossy finish horizontal grain, Th. 20 mm with matt white melamine-faced interior, in the following colours: grey larch (opt.297P), white larch (opt.298P)

GLASS DOORS

standard: Th. 20 mm polymer-coated MDF frame with same finish as door. Satin glass th. 4 mm.

on request: Th. 20 mm aluminium frame, brill finish. Satin glass th. 4 mm.

FINGER RAIL

standard: polished aluminium (opt.410)

on request: aluminium with semi-polished white finish (opt.001)
aluminium with semi-polished beige finish (opt.444)
aluminium with matt brown finish (opt.370)

CARCASSES

DOORS: MATT AND GLOSSY ABSOLUTE WHITE, MATT PETROLEUM BLUE, MATT SILK GREY, GLOSSY STEAM GREY, LIGHT WALNUT, GREY WALNUT, MATT WHITE LARCH, MATT DUST GREY, GLOSSY ALPACA LIGHT BLUE, ROUGH-HEWN CHAMPAGNE OAK, WHITE ASH, GLOSSY GREY LARCH, GLOSSY WHITE LARCH, MATT AND GLOSSY AUBERGINE
melamine-coated white (opt.001), white back panel and shelf (opt.001)

DOORS: GRAVEL GREY, ROUGH-HEWN MINK OAK
melamine-faced devalè with grafis finish (opt.796), white (opt.001) back panel and shelf

DOORS: MATT KASHMIR, MATT AND GLOSSY DARK DOVE GREY, MUSTARD, BEIGE, DAKAR ASH
melamine-faced oriental pearl (opt.940), ivory (opt.930) back panel and shelf

DOORS: ASH OAK, MATT GRAPHITE, ANTHRACITE
melamine-faced ash oak (opt.261), white (opt.001) back panel and shelf

DOOR: BURNT ELM
melamine-faced dark brown larch (opt.218), white (opt.001) back panel and shelf

DOOR: STONE GREY ASH
melamine-faced mink (opt.948M), white (opt.001) back panel and shelf

SHELVES

standard: height 3.8 cm, laminate in the colours white (opt.001), oriental pearl (opt.940), devalè with grafis finish (opt.796), ash oak (opt.261), dark brown larch (opt.218), mink (opt.948M)

on request: height 3.8 cm polymer-coated, for the finishes see door colour

PLINTHS

standard: height 13 cm, melamine-faced pvc with steel finish (opt.407)

on request: height 13 cm, melamine-faced pvc with satin aluminium finish (opt.405)
height 13 cm, white melamine-faced pvc (opt.001)
height 13 cm, aluminium with brill finish (opt.412), semi-glossy white (opt.A001), **see surcharges on page 156**

kyra NECK polimerico opaco matt polymeric

cod. **KG7**

ante doors

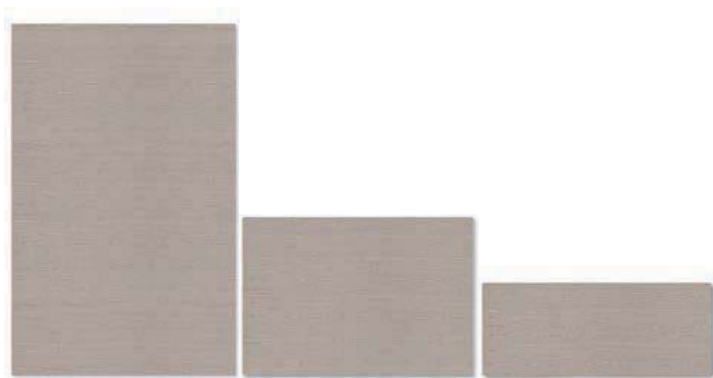

frassino dakar (opz.2412)
dakar ash (opt.2412)

cestone frassino dakar
(opz.2412)
dakar ash deep drawer
(opt.2412)

cassetto frassino dakar
(opz.2412)
dakar ash drawer (opt.2412)

SP. 20 MM TH.20 MM

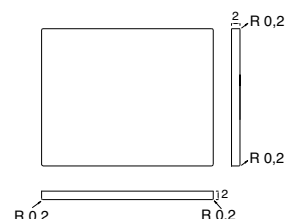

ante vetro di serie standard glass doors



telaio in polimerico
finitura frassino dakar
(opz.2412), vetro satinato
polymer-coated frame
with dakar ash finish
(opt.2412), satin glass

telaio cestone in polimerico
finitura frassino dakar
(opz.2412), vetro satinato
polymer-coated deep drawer
frame with dakar ash finish
(opt.2412), satin glass

a richiesta: ante vetro telaio alluminio brill standard: glass doors with brill aluminium frame

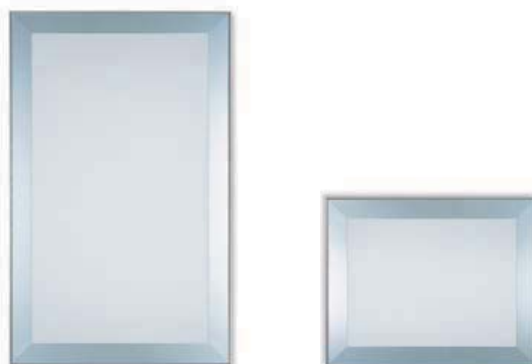

anta telaio alluminio brill,
vetro satinato (opz.419S)
door with aluminium frame brill finish
satin glass (opt.419S)

cestone vetro telaio alluminio finitura brill,
vetro satinato (opz.419S)
door deep drawer with aluminium frame
brill finish, satin glass (opt.419S)

SP. 20 MM TH. 20 MM

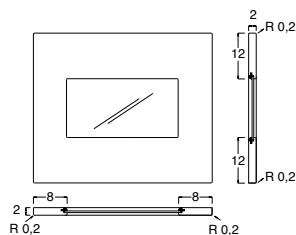

SP. 20 MM TH. 20 MM

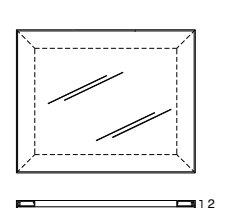

kyra NECK polimerico opaco matt polymeric

cod. **KG7**

colori tinta unita opachi matt solid colours

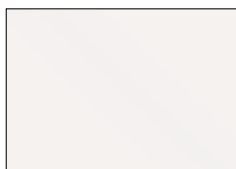

bianco assoluto (opz.740P)
absolute white (opt.740P)



tortora scuro (opz.8981)
dark dove grey (opt.8981)

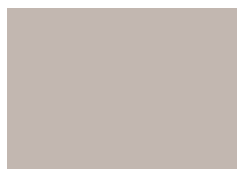

kaschmir (opz.7713)
kaschmir (opt.7713)



grigio seta (opz.9605)
silk grey (opt.9605)



melanzana (opz.270P)
aubergine (opt.270P)

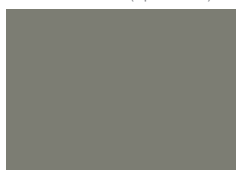

verde lichene (opz.8441)
lichen green (opt.8441)



grigio polvere (opz.9617)
dust grey (opt.9617)

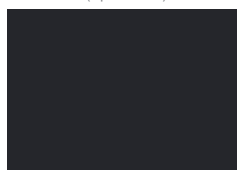

grafite (opz.9619)
graphite (opt.9619)

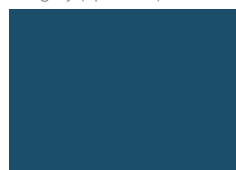

blu petrolio (opz.8325)
petroleum blue (opt.8325)

colori legno opachi matt wood colours



larice bianco (opz.295P)
white larch (opt.295P)



noce chiaro (opz.238P)
light walnut (opt.238P)



noce grigio (opz.239P)
grey walnut (opt.239P)



rovere cenere (opz.260P)
ash oak (opt.260P)

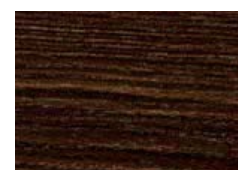

olmo cotto (opz.5072)
burnt elm (opt.5072)



tranchè rovere champagne (opz.5273)
tranchè champagne oak (opt.5273)



tranchè rovere visone (opz.5275)
tranchè mink oak (opt.5275)

NEW

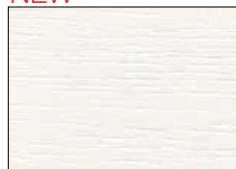

frassino white (opz.2411)
white ash (opt.2411)

NEW

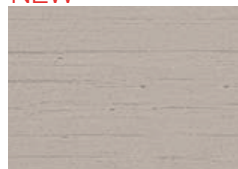

frassino dakar (opz.2412)
dakar ash (opt.2412)

NEW

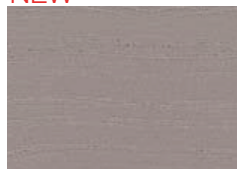

frassino stone grey (opz.2413)
stone grey ash (opt.2413)

NEW

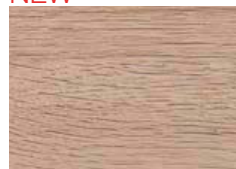

rovere naturale (opz.5344)
natural oak (opt.5344)

colore interno delle ante internal door colour



bianco opaco
matt white

kyra NECK polimerico lucido glossy polymeric

cod. **KG7**

ante doors

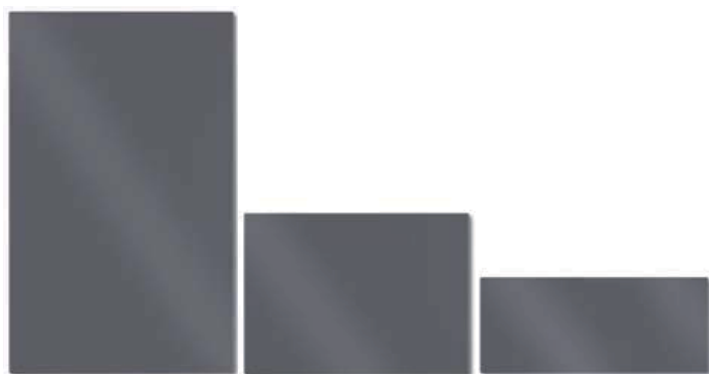

antracite (opz.9602)
anthracite (opt.9602)

cestone antracite
(opz.9602)
deep drawer
anthracite (opt.9602)

cassetto antracite
(opz.9602)
drawer
anthracite (opt.9602)

SP. 20 MM TH.20 MM

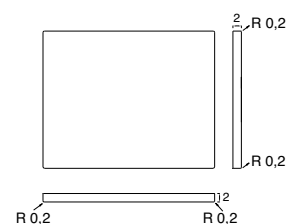

ante vetro di serie standard glass doors

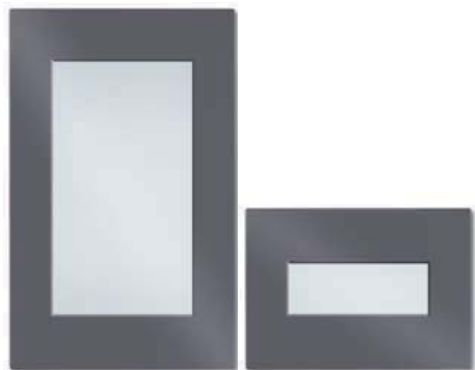

telaio in polimerico
finitura antracite
(opz.9602), vetro satinato
polymeric frame with
anthracite finish
(opt.9602), satin glass

telaio cestone in polimerico
finitura antracite
(opz.9602), vetro satinato
deep drawer, polymeric frame
with anthracite finish
(opt.9602), satin glass

a richiesta: ante vetro telaio alluminio brill standard: glass doors with brill aluminium frame

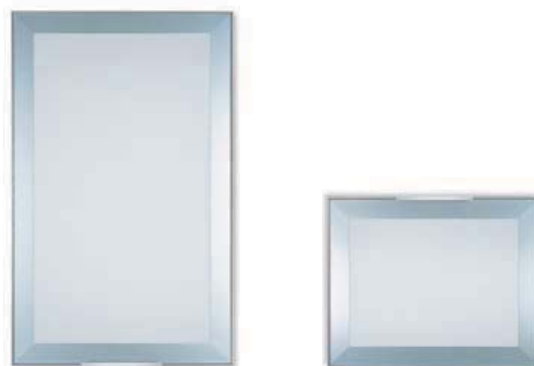

anta telaio alluminio brill,
vetro satinato (opz.419S)
door with aluminium frame brill finish
satin glass (opt.419S)

cestone vetro telaio alluminio finitura brill,
vetro satinato (opz.419S)
door deep drawer with aluminium frame
brill finish, satin glass (opt.419S)

SP. 20 MM TH. 20 MM

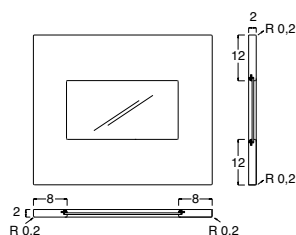

SP. 20 MM TH. 20 MM

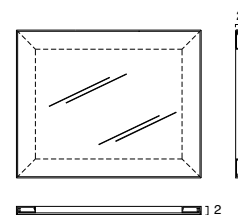

kyra NECK polimerico lucido glossy polymeric

cod. **KG7**

colori tinta unita lucidi glossy solid colours

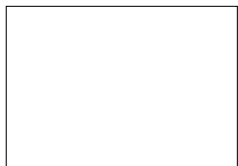

bianco assoluto (opz.741P)
absolute white (opt.741P)



tortora scuro (opz.8982)
dark dove grey (opt.8982)



beige (opz.7712)
beige (opt.7712)



grigio vapore (opz.9608)
steam grey (opt.9608)



antracite (opz.9602)
anthracite (opt.9602)



celesti alpaca (opz.8322)
alpaca light blue (opt.8322)



senape (opz.8224)
mustard (opt.8224)



grigio ghiaia (opz.9612)
gravel grey (opt.9612)



melanzana (opz.271P)
aubergine (opt.271P)

colori legno lucidi glossy wood colours



larice grigio (opz.297P)
grey larch (opt.297P)

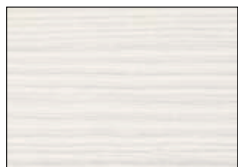

larice bianco (opz.298P)
white larch (opt.298P)

colore interno delle ante internal door colour



bianco opaco
matt white

CARATTERISTICHE TECNICHE

ANTE E FRONTALI CASSETTI in MDF poliestereato 1 lato e bordi, retro in tinta laccato opaco, sp.20 mm finitura opaca soft nei colori: bianco caldo (opz.7401), tortora (opz.8991), visone (opz.946S), fango (opz.8905), bianco assoluto (opz.740S), cenere (opz.9547), avorio (opz.767S), cappuccino (opz.7771), lime (opz.8461), grigio argento (opz.9541), titanio (opz.9545), rosso (opz.125S), lavanda (opz.9141), lillà (opz.392S), glicine (opz.920S), rubino (opz.8151), prugna (opz.8631), blu aviazione (opz.8363), mandarino (opz.8155), lavagna (opz.9543), blu laguna (opz.8365), oro vecchio (opz.933S), blu oltremare (opz.922S), caffè (opz.887S), verde provenza (opz.8465), rosa quarzo (opz.8181), verde lichene (opz.8463), giallo ambra (opz.327S), grigio perla (opz.9555), nero assoluto (opz.786S)

in MDF poliestereato 1 lato e bordi, retro in tinta laccato opaco, sp.20 mm finitura lucida diretta nei colori: bianco caldo (opz.7402), tortora (opz.8992), visone (opz.947), fango (opz.8906), bianco assoluto (opz.741), cenere (opz.9548), avorio (opz.768), cappuccino (opz.7772), lime (opz.8462), grigio argento (opz.9542), titanio (opz.9546), rosso (opz.126), lavanda (opz.9142), lillà (opz.393), glicine (opz.921), rubino (opz.8152), prugna (opz.8632), blu aviazione (opz.8364), mandarino (opz.8156), lavagna (opz.9544), blu laguna (opz.8366), oro vecchio (opz.934), blu oltremare (opz.923), caffè (opz.888), verde provenza (opz.8466), rosa quarzo (opz.8182), verde lichene (opz.8464), giallo ambra (opz.328), grigio perla (opz.9556), nero assoluto (opz.787)

anta in MDF sp.20 mm laccata peltro 1 lato e bordi, retro opaco (opz.9549)

ANTE VETRO di serie: telaio in alluminio finitura brill sp.20 mm, vetro satinato sp.4 mm

a richiesta: telaio in MDF laccato peltro sp mm 20, vetro retinato sp.6 mm

di serie per anta PELTRO: telaio in MDF laccato peltro sp mm 20, vetro retinato sp.6 mm

GOLA di serie: alluminio lucido (opz.410)

a richiesta: alluminio finitura bianco semilucido (opz.001)
alluminio finitura beige semilucido (opz.444)
alluminio finitura brown opaco (opz.370)

STRUTTURE di serie: nobilitato perla d'oriente (opz.940), schiena e ripiano avorio (opz.930)

a richiesta: nobilitato bianco (opz.001), schiena e ripiano bianco (opz.001)
nobilitato visone (opz.948M) schiena e ripiano bianco (opz.001)
nobilitato devalè finitura grafis (opz.796), schiena e ripiano bianco (opz.001)

di serie per anta PELTRO: nobilitato visone (opz.948M) schiena e ripiano bianco (opz.001)



MENSOLE di serie: altezza 3,8 cm in laminato bianco (opz.001), perla d'oriente (opz.940), visone (opz.948M), devalè finitura grafis (opz.796)
a richiesta: altezza 3,8 cm laccate per le finiture vedi colore ante

ZOCCOLI di serie: altezza 13 cm in PVC ricoperti in melamina finitura acciaio (opz.407)

a richiesta: altezza 13 cm in PVC ricoperti in melamina colore alluminio satinato (opz.405)
altezza 13 cm in PVC ricoperti in melamina bianco (opz.001)
altezza 13 cm in alluminio finitura brill (opz.412), bianco semilucido (opz.A001), vedi maggiorazioni pag.156
altezza 13 cm in PVC laccato peltro (opz.L9549), vedi maggiorazioni pag.156

TECHNICAL SPECIFICATIONS

DOORS AND DRAWERS FRONTS

Polyester-coated MDF 1 side and edges, matt lacquered matching rear, Th. 20 mm, soft matt finish in the following colours: warm white (opt.7401), dove grey (opt.8991), mink (opt.946S), mud (opt.8905), absolute white (opt.740S), ash (opt.9547), ivory (opt.767S), cappuccino (opt.7771), lime (opt.8461), silver grey (opt.9541), titanium (opt.9545), red (opt.125S), lavender (opt.9141), lilac (opt.392S), wisteria (opt.920S), ruby (opt.8151), plum (opt.8631), aviation blue (opt.8363), mandarin (opt.8155), slate grey (opt.9543), lagoon blue (opt.8365), old gold (opt.933S), ultramarine blue (opt.922S), coffee (opt.887S), provence green (opt.8465), quartz pink (opt.8181), lichen green (opt.8463), amber yellow (opt.327S), pearl grey (opt.9555), absolute black (opt.786S)

Polyester-coated MDF 1 side and edges, matt lacquered matching rear, Th. 20 mm, direct glossy finish in the following colours: warm white (opt.7402), dove grey (opt.8992), mink (opt.947), mud (opt.8906), absolute white (opt.741), ash (opt.9548), ivory (opt.768), cappuccino (opt.7772), lime (opt.8462), silver grey (opt.9542), titanium (opt.9546), red (opt.126), lavender (opt.9142), lilac (opt.393), wisteria (opt.921), ruby (opt.8152), plum (opt.8632), aviation blue (opt.8364), mandarin (opt.8156), slate grey (opt.9544), lagoon blue (opt.8366), old gold (opt.934), ultramarine blue (opt.923), coffee (opt.888), provence green (opt.8466), quartz pink (opt.8182), lichen green (opt.8464), amber yellow (opt.328), pearl grey (opt.9556), absolute black (opt.787)

MDF panel, Th. 20 mm, pewter lacquered on 1 side and edges, matt rear (opt.9549)

GLASS DOORS

standard: Th. 20 mm aluminium frame, brill finish. Satin glass th. 4 mm.

on request: pewter matt lacquered MDF frame Th. 20 mm, with 6 mm thick wired glass

standard for PEWTER door: matt lacquered MDF frame Th. 20 mm, with 6 mm thick wired glass

FINGER RAIL

standard: polished aluminium (opt.410)

on request: aluminium with semi-polished white finish (opt.001)
aluminium with semi-polished beige finish (opt.444)
aluminium with matt brown finish (opt.370)

CARCASSES

standard: melamine-faced oriental pearl (opt.940), ivory (opt.930) back panel and shelf

on request: melamine-coated white (opt.001), white back panel and shelf (opt.001)
melamine-faced mink (opt.948M), white (opt.001) back panel and shelf
melamine-faced devalè with grafis finish (opt.796), white (opt.001) back panel and shelf

standard for PEWTER door: melamine-faced mink (opt.948M), white (opt.001) back panel and shelf

SHELVES

standard: height 3.8 cm, laminate in the colours white (opt.001), oriental pearl (opt.940), mink (opt.948M), devalè with grafis finish (opt.796)

on request: height 3.8 cm lacquered, for the finishes see door colour

PLINTHS

standard: height 13 cm, melamine-faced pvc with steel finish (opt.407)

on request: height 13 cm, melamine-faced pvc with satin aluminium finish (opt.405)
height 13 cm, white melamine-faced pvc (opt.001)
height 13 cm, aluminium with brill finish (opt.412), semi-glossy white (opt.A001), **see surcharges on page 156**
height 13 cm, pewter lacquered pvc (opt.L9549), **see surcharges on page 156**

kyra NECK

laccato lacquered

PREZZI FASCIA "A" CATEGORY "A" PRICES

cod. **KG8**

ante doors



tortora opaco (opz.8991)
matt dove grey (opt.8991)



cestone tortora opaco (opz.8991)
matt dove grey deep drawer
(opt.8991)



cassetto tortora opaco (opz.8991)
matt dove grey drawer (opt.8991)

SP. 20 MM TH. 20 MM

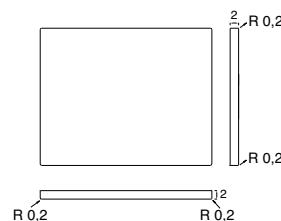

di serie: ante vetro telaio alluminio brill
standard: glass doors with brill aluminium frame

a richiesta: ante vetro effetto vintage **NEW**
on request: vintage effect glass door



anta telaio alluminio brill,
vetro satinato (opz.419S)
door with aluminium frame brill finish
satin glass (opt.419S)

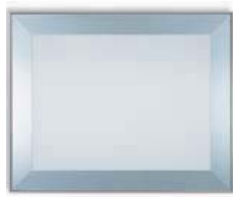

cestone vetro telaio alluminio finitura brill,
vetro satinato (opz.419S)
door deep drawer with aluminium frame
brill finish, satin glass (opt.419S)



telaio in mdf laccato peltro,
vetro retinato (opz.9549)
mdf frame with pewter finish,
wired glass (opt.9549)



cestone vetro telaio in mdf
laccato peltro,
vetro retinato (opz.9549)
glass deep drawer mdf frame
with pewter finish,
wired glass (opt.9549)

SP. 20 MM TH. 20 MM

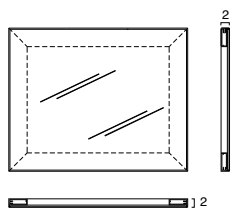

SP. 20 MM TH. 20 MM

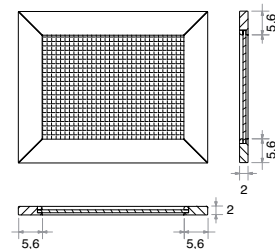

ante laccato opaco finitura soft, retro laccato opaco in tinta

matt lacquered doors with soft finish, rear with matching matt lacquered finish



NEW

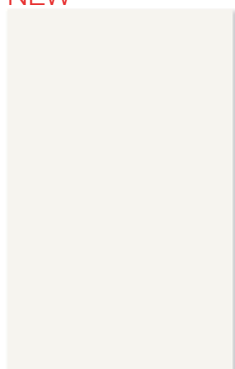

bianco caldo
(opz.7401)
warm white (opt.7401)



tortora
(opz.8991)
dove grey (opt.8991)



visone
(opz.946S)
mink (opt.946S)

NEW



fango
(opz.8905)
mud (opt.8905)

ante laccato lucido finitura lucido diretto, retro laccato opaco in tinta

glossy lacquered doors with direct finish, rear with matching matt lacquered finish



NEW



bianco caldo
(opz.7402)
warm white (opt.7402)



tortora
(opz.8992)
dove grey (opt.8992)



visone
(opz.947)
mink (opt.947)

NEW



fango
(opz.8906)
mud (opt.8906)

kyra NECK laccato lacquered

cod. **KG8** PREZZI FASCIA "B" CATEGORY "B" PRICES

ante laccato opaco finitura soft, retro laccato opaco in tinta
 matt lacquered doors with soft finish, rear with matching matt lacquered finish



verde lichene (opz.8463)
 green lichene (opt.8463)



cestone verde lichene (opz.8463)
 green lichene deep drawer
 (opt.8463)



cassetto verde lichene (opz.8463)
 green lichene drawer (opt.8463)

SP. 20 MM TH. 20 MM

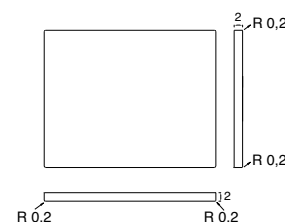

di serie: ante vetro telaio alluminio brill
 standard: glass doors with brill aluminium frame



anta telaio alluminio brill,
 vetro satinato (opz.419S)
 door with aluminium frame brill finish
 satin glass (opt.419S)

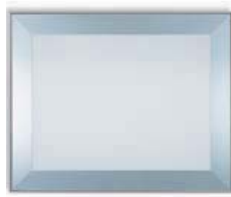

cestone vetro telaio alluminio finitura brill,
 vetro satinato (opz.419S)
 door deep drawer with aluminium frame
 brill finish, satin glass (opt.419S)

a richiesta: ante vetro effetto vintage **NEW**
 on request: vintage effect glass door



telaio in mdf laccato peltro,
 vetro retinato (opz.9549)
 mdf frame with pewter finish,
 wired glass (opt.9549)



cestone vetro telaio in mdf
 laccato peltro,
 vetro retinato (opz.9549)
 glass deep drawer mdf frame
 with pewter finish,
 wired glass (opt.9549)

SP. 20 MM TH. 20 MM

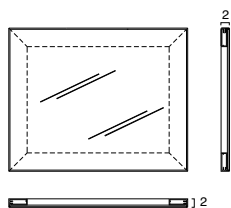

SP. 20 MM TH. 20 MM

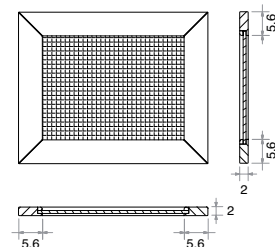

kyra NECK laccato lacquered

cod. **KG8**

PREZZI FASCIA "B" CATEGORY "B" PRICES

colori opachi finitura soft, retro laccato opaco in tinta
 matt colours with soft finish, rear with matching matt lacquered finish

<p>bianco assoluto opaco (opz.740S) matt absolute white</p>	<p>cenere opaco (opz.9547) matt ash</p>	<p>verde provenza opaco (opz.8465) matt provence green</p>	<p>titanio opaco (opz.9545) matt titanium</p>	<p>cappuccino opaco (opz.7771) matt cappuccino</p>	<p>caffè opaco (opz.887S) matt coffee</p>	<p>verde lichene opaco (opz.8463) matt green lichen</p>
<p>rosa quarzo opaco (opz.8181) matt quartz pink</p>	<p>lavanda opaco (opz.9141) matt lavender</p>	<p>blu laguna opaco (opz.8365) matt lagoon blue</p>	<p>avorio opaco (opz.767S) matt ivory</p>	<p>rosso opaco (opz.125S) matt red</p>	<p>rubino opaco (opz.8151) matt ruby</p>	<p>lavagna opaco (opz.9543) matt slate grey</p>
<p>lime opaco (opz.8461) matt lime</p>	<p>giallo ambra opaco (opz.327S) matt amber yellow</p>	<p>oro vecchio opaco (opz.933S) matt old gold</p>	<p>mandarino opaco (opz.8155) matt mandarin</p>	<p>blu oltremare opaco (opz.922S) matt ultramarine</p>	<p>prugna opaco (opz.8631) matt plum</p>	<p>grigio perla opaco (opz.9555) matt pearl grey</p>
<p>grigio argento opaco (opz.9541) matt silver grey</p>	<p>lilla opaco (opz.392S) matt lilac</p>	<p>glicine opaco (opz.920S) matt wisteria</p>	<p>blu aviazione opaco (opz.8363) matt aviation blue</p>	<p>nero assoluto opaco (opz.786S) matt absolute black</p>		

colori a campione RAL maggiorazione del 35% rispetto alla fascia A
 RAL sample colours with 35% surcharge more than category A

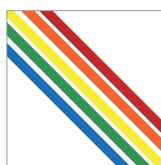

colore a campione RAL (opz.998)
 RAL sample colours

CONSEGNA: MINIMO 5 SETTIMANE DALLA CONFERMA DELL' ORDINE
 DELIVERY: MINIMUM 5 WEEKS FROM ORDER CONFIRMATION

kyra NECK laccato lacquered

cod. **KG8**

PREZZI FASCIA "B" CATEGORY "B" PRICES

ante laccato lucido finitura lucido diretto, retro laccato opaco in tinta
glossy lacquered doors with direct finish, rear with matching matt lacquered finish



blu aviazione (opz.8364)
aviation blue (opt.8364)



cestone blu aviazione (opz.8364)
aviation blue deep drawer (opt.8364)



cassetto blu aviazione (opz.8364)
aviation blue drawer (opt.8364)

SP. 20 MM TH. 20 MM

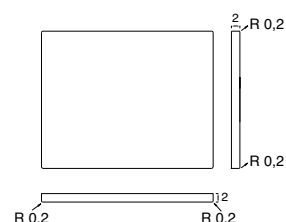

di serie: ante vetro telaio alluminio brill
standard: glass doors with brill aluminium frame

a richiesta: ante vetro effetto vintage **NEW**
on request: vintage effect glass door



anta telaio alluminio brill,
vetro satinato (opz.419S)
door with aluminium frame brill finish
satin glass (opt.419S)



cestone vetro telaio alluminio finitura brill,
vetro satinato (opz.419S)
door deep drawer with aluminium frame
brill finish, satin glass (opt.419S)



telaio in mdf laccato peltro,
vetro retinato (opz.9549)
mdf frame with pewter finish,
wired glass (opt.9549)



cestone vetro telaio in mdf
laccato peltro,
vetro retinato (opz.9549)
glass deep drawer mdf frame
with pewter finish,
wired glass (opt.9549)

SP. 20 MM TH. 20 MM

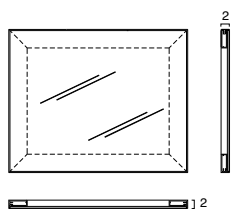

SP. 20 MM TH. 20 MM

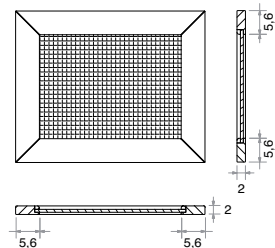

kyra NECK

cod. **KG8**

laccato lacquered **PREZZI FASCIA "B" CATEGORY "B" PRICES**

colori lucidi finitura lucido diretto, retro laccato opaco in tinta
glossy colours with direct finish, rear with matching matt lacquered finish



colori a campione RAL maggiorazione del 35% rispetto alla fascia A
RAL sample colours with 35% surcharge more than category A

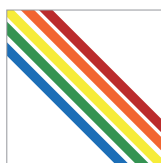

colore a campione RAL (opz.998)
RAL sample colours

CONSEGNA: MINIMO 5 SETTIMANE DALLA CONFERMA DELL' ORDINE
DELIVERY: MINIMUM 5 WEEKS FROM ORDER CONFIRMATION

kyra NECK laccata peltro pewter lacquered

cod. **KG8**

ante doors **NEW**



peltro (opz.9549)
pewter (opt.9549)



cestone peltro (opz.9549)
pewter deep drawer (opt.9549)



cassetto peltro (opz.9549)
pewter drawer (opt.9549)

SP. 20 MM TH. 20 MM

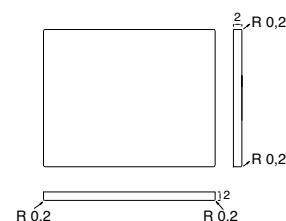

ante vetro glass doors **NEW**



telaio in mdf laccato peltro, vetro retinato (opz.9549)
mdf frame with pewter finish, wired glass (opt.9549)



cestone vetro telaio in mdf laccato peltro, vetro retinato (opz.9549)
glass deep drawer mdf frame with pewter finish, wired glass (opt.9549)

SP. 20 MM TH. 20 MM

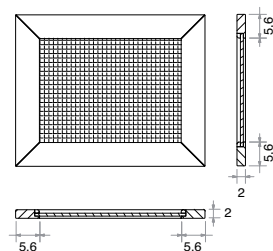



CARATTERISTICHE TECNICHE

ANTE E FRONTALI CASSETTI **anta in MDF sp.20 mm lato esterno in acrilico opaco glaks sp.2 mm lato interno acrilico opaco stesso colore esterno sp.2 mm** squadrata e bordata 4 lati, bordo in tinta 1 mm spigolata sui 4 lati effetto vetro **nei colori opachi:** glaks bianco (opz.7491), glaks fango (opz.8883), glaks blu giulietta (opz.8343), glaks mattone (opz.8143), glaks grigio reale (opz.9563), glaks rosa colorado (opz.8141)

anta in MDF sp.20 mm lato esterno in acrilico lucido glaks sp.2 mm lato interno acrilico opaco stesso colore esterno sp.2 mm squadrata e bordata 4 lati, bordo in tinta 1 mm spigolata sui 4 lati effetto vetro **nei colori lucidi:** glaks bianco (opz.7492), glaks fango (opz.8884), glaks blu giulietta (opz.8344), glaks mattone (opz.8144), glaks grigio reale (opz.9564), glaks rosa colorado (opz.8142)

GOLA di serie: **alluminio lucido (opz.410)**

a richiesta: alluminio finitura bianco semilucido (opz.001)
alluminio finitura beige semilucido (opz.444)
alluminio finitura brown opaco (opz.370)

STRUTTURE

di serie: nobilitato bianco (opz.001), schiena e ripiano bianco (opz.001)

a richiesta: nobilitato perla d'oriente (opz.940), schiena e ripiano avorio (opz.930)
nobilitato visone (opz.948M) schiena e ripiano bianco (opz.001)



MENSOLE

altezza 3,8 cm in laminato bianco (opz.001), perla d'oriente (opz.940), visone (opz.948M)

ZOCCOLI

di serie: altezza 13 cm in pvc ricoperti in melamina finitura acciaio (opz.407)

a richiesta: altezza 13 cm in pvc ricoperti in melamina colore alluminio satinato (opz.405)
altezza 13 cm in pvc ricoperti in melamina bianco (opz.001)

altezza 13 cm in alluminio finitura brill (opz.412), bianco semilucido (opz.A001), [vedi maggiorazioni pag.156](#)

TECHNICAL SPECIFICATIONS

DOORS AND DRAWERS FRONTS

MDF door, Th. 20 mm, 2 mm thick glaks matt acrylic exterior, 2 mm matt acrylic interior same colour as exterior, square-shaped and edged on 4 sides with 1 mm matching edge, sharp edge on 4 sides, glass effect in the following matt colours: glaks white (opt.7491), glaks mud (opt.8883), glaks juliet blue (opt.8343), glaks brick (opt.8143), glaks real grey (opt.9563), glaks colorado pink (opt.8141)

MDF door, Th. 20 mm, 2 mm thick glossy glaks acrylic exterior, 2 mm matt acrylic interior same colour as exterior, square-shaped and edged on 4 sides with 1 mm matching edge, sharp edge on 4 sides, glass effect in the following glossy colours: glaks white (opt.7492), glaks mud (opt.8884), glaks juliet blue (opt.8344), glaks brick (opt.8144), glaks real grey (opt.9564), glaks colorado pink (opt.8142)

FINGER RAIL

standard: polished aluminium (opt.410)

on request: aluminium with semi-polished white finish (opt.001)
aluminium with semi-polished beige finish (opt.444)
aluminium with matt brown finish (opt.370)

CARCASSES

standard: melamine-coated white (opt.001), white back panel and shelf (opt.001)

on request: melamine-faced oriental pearl (opt.940), ivory (opt.930) back panel and shelf
melamine-faced mink (opt.948M), white (opt.001) back panel and shelf

SHELVES

height 3.8 cm, laminate in the colours: white (opt.001), oriental pearl (opt.940), mink (opt.948M)

PLINTHS

standard: height 13 cm, melamine-faced pvc with steel finish (opt.407)

on request: height 13 cm, melamine-faced pvc with satin aluminium finish (opt.405)
height 13 cm, white melamine-faced pvc (opt.001)
height 13 cm, aluminium with brill finish (opt.412), semi-glossy white (opt.A001), [see surcharges on page 156](#)

kyra glaks

NECK

cod. **KG3**

ante acrilico effetto vetro, retro acrilico opaco in tinta
 glass effect acrylic doors, rear with matching matt acrylic finish

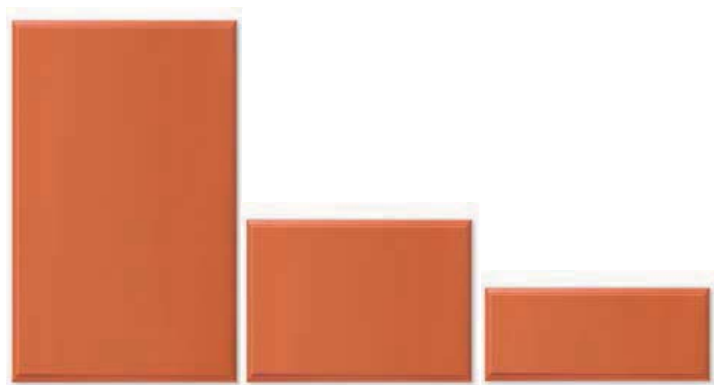

anta mattone (opz.8143)
brick door (opt.8143)

cestone mattone (opz.8143)
brick deep drawer (opt.8143)

cassetto mattone (opz.8143)
brick drawer (opt.8143)

SP. 20 MM TH.20 MM

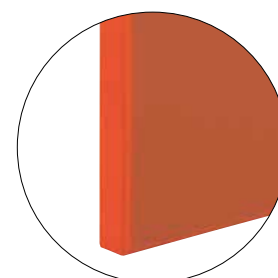
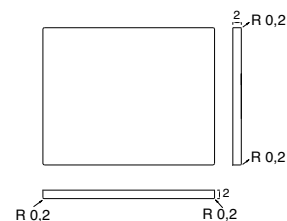

particolare anta
doors detail



glaks blu giulietta opaco (opz.8343)
lucido (opz.8344)
glaks juliet blue matt (opt.8343)
glossy (opt.8344)



glaks mattone opaco (opz.8143)
lucido (opz.8144)
glaks brick matt (opt.8143)
glossy (opt.8144)



glaks bianco opaco (opz.7491)
lucido (opz.7492)
glaks white matt (opt.7491)
glossy (opt.7492)

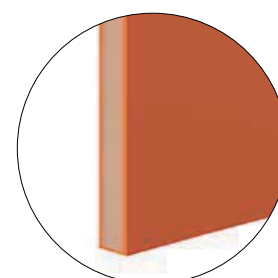

particolare anta sezionata
doors detail sectioned



glaks fango opaco (opz.8883)
lucido (opz.8884)
glaks mud matt (opt.8883)
glossy (opt.8884)

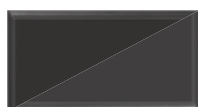

glaks grigio reale opaco (opz.9563)
lucido (opz.9564)
glaks real grey matt (opt.9563)
glossy (opt.9564)

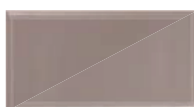

glaks rosa colorado opaco (opz.8141)
lucido (opz.8142)
glaks colorado pink matt (opt.8141)
glossy (opt.8142)



kyra NECK

strutture carcasses



bianco (opz.001)
schiena e ripiano bianco
(opz.001)
white (opt.001)
white back panel and shelf
(opt.001)



perla d'oriente (opz.940)
schiena e ripiano avorio
(opz.930)
oriental pearl (opt.940)
ivory back panel and shelf
(opt.930)



visone (opz.948M)
schiena e ripiano bianco
(opz.001)
mink (opt.948M)
white back panel and shelf
(opt.001)



devalè finitura grafis
(opz.796) schiena e ripiano
bianco (opz.001)
devalè with grafis finish
(opt.796)
white back panel and shelf
(opt.001)



rovere cenere (opz.261)
schiena e ripiano bianco
(opz.001)
ash oak (opt.261)
white back panel and shelf
(opt.001)



larice moro (opz.218)
schiena e ripiano bianco
(opz.001)
dark larch (opt.218)
white back panel and shelf
(opt.001)



CREO ECOLOGIC

IL GRUPPO LUBE HA SCELTO DI UTILIZZARE PER I COMPONENTI COSTITUENTI LE STRUTTURE DELLE CUCINE SOLO MATERIALE A BASSISSIMA EMISSIONE DI FORMALDEIDE: CONFORME ALLO STANDARD FASTELLE SECONDO LA NORMA JIS, CERTIFICATO DAL MINISTERO GIAPPONESE, IL PIÙ SEVERO IN MERITO ALLE NORMATIVE DI SALVAGUARDIA AMBIENTALE.

LUBE GROUP HAS CHOSEN TO EXCLUSIVELY USE MATERIALS WITH VERY LOW FORMALDEHYDE EMISSIONS FOR THE COMPONENTS MAKING UP THE KITCHEN CARCASSES. THESE ELEMENTS COMPLY WITH THE F4 STAR STANDARD ACCORDING TO JIS, CERTIFIED BY THE JAPANESE GOVERNMENT - THE MOST STRINGENT WHEN IT COMES TO ENVIRONMENTAL PROTECTION.

gole finger rails



alluminio lucido (opz.410)
polished aluminium
(opt.410)



alluminio finitura bianco
semilucido (opz.001)
aluminium with semi-polished
white finish (opt.001)



alluminio finitura brown
opaco (opz.370)
aluminium with matt brown
finish (opt.370)



alluminio finitura beige
semilucido (opz.444)
aluminium with semi-polished
beige finish (opt.444)

zoccoli in pvc H 13

pvc plinths H 13



acciaio (opz.407)
steel (opt.407)



alluminio satinato
(opz.405)
satin aluminium
(opt.405)



bianco (opz.001)
white (opt.001)

zoccoli in alluminio H 13

aluminium plinths H 13



alluminio
finitura brill (opz.412)
aluminium with
brill finish (opt.412)



alluminio bianco
semilucido (opz.A001)
semi-polished white
aluminium (opt.A001)



alluminio brown
semilucido (opz.A370)
semi-polished brown
aluminium (opt.A370)

**magg. rispetto allo zoccolo standard
surcharges compared to standard plinth**

al ml
per lm

cod.092125
code

+20 €

kyra

NECK

mensole in laminato laminated shelves



bianco (opz.001)
white (opt.001)



perla d'oriente (opz.940)
oriental pearl (opt.940)

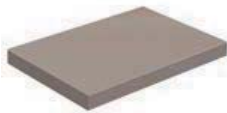

visone (opz.948M)
mink (opt.948M)



devalè finitura grafis
(opz.796)
devalè with grafis finish (opt.796)



rovere cenere (opz.261)
ash oak (opt.261)



larice moro (opz.218)
dark larch (opt.218)

mensole in laminato come ante melaminico laminated shelves same as melamine doors



rovere bianco spazzolato
(opz.5311)
brushed white oak (opt.5311)



rovere cipria spazzolato
(opz.5312)
brushed powder oak (opt.5312)



abete nordico bianco
(opz.4406)
white nordic fir (opt.4406)



abete nordico terra (opz.4407)
earth nordic fir (opt.4407)



rovere naturale vintage
(opz.5310)
vintage natural oak (opt.5310)

mensole laccate lacquered shelves



bianco caldo (opz.7401)
warm white (opt.7401)

per le finiture vedi ante pag.145-147-149
for the finishes see doors on page 145-147-149

mensole polimerico polymeric shelves



per le finiture vedi ante pag.139-141
for the finishes see doors on page 139-141

mensole in polimerico nei colori degli elementi a giorno polymeric shelves same colours as open units



acquamarina (opz.8323)
acquamarine (opt.8323)

COLORI COLOURS

bruno antilope
(opz.9451)
antelope brown

acquamarina
(opz.8323)
acquamarine

giallo ambra
(opz.8225)
amber yellow

rosa quarzo
(opz.8171)
quartz pink

rosso corallo
(opz.8131)
coral red

salvia
(opz.8443)
sage

vulcano
(opz.9615)
volcano

kyra

NECK

top H 4 consigliati in laminato bordo postformato

recommended laminate worktops H 4 with post-formed edge



top H 4 consigliati in laminato bordo ABS 1

recommended laminate worktops H 4 with ABS 1 edge

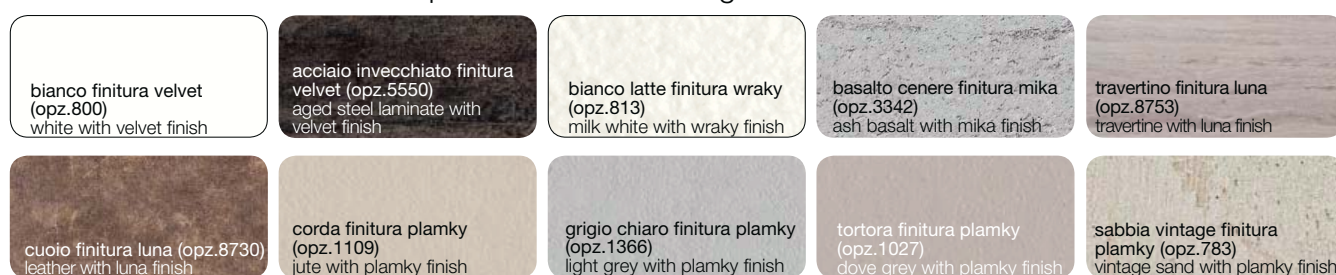

consigli per abbinamento dei colori
recommended colour combinations

ante
doors



rovere cipria spazzolato
(opz.5312)
brushed powder oak
(opt.5312)



rovere bianco spazzolato
(opz.5311)
brushed white oak
(opt.5311)



verde lichene lucido
(opz.8464)
green lichen
glossy (opt.8464)



abete nordico bianco
(opz.4406)
white nordic fir (opt.4406)



fango lucido (opz.8906)
mud glossy (opt.8906)



frassino dakar (opz.2412)
dakar ash (opt.2412)

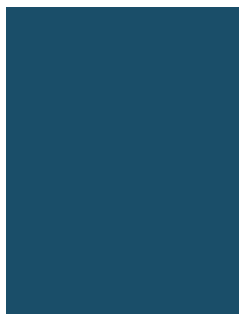

blu petrolio (opz.8325)
petroleum blue (opt.8325)

elementi a giorno
open units

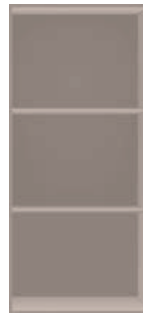

bruno antilope (opz.9451)
antelope brown (opt.9451)



rosa quarzo (opz.8171)
quartz pink (opt.8171)

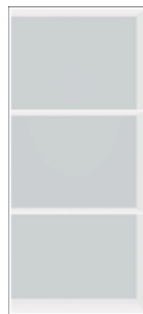

bianco assoluto (opz.740P)
absolute white (opt.740P)

top
worktops

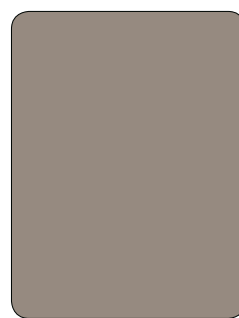

top laminato fenix castoro (opz.0717)
laminato fenix worktop
beaver (opt.0717)



top quarzo new titan lucido (opz.T208)
quartz worktop
new titan glossy (opt.T208)



top betacryl classic white (opz.B100)
betacryl worktop
classic white (opt.B100)

consigli per abbinamento dei colori
recommended colour combinations

ante
doors



abete nordico terra
(opt.4407)

earth nordic fir (opt.4407)

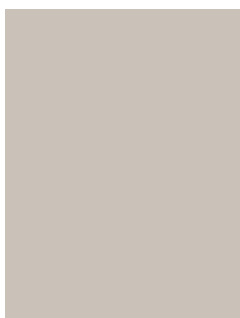

tortora opaco
(opt.8991)

dove grey matt (opt.8991)



rovere naturale vintage
(opt.5310)

vintage natural oak
(opt.5310)



verde lichene (opt.8441)

lichen green (opt.8441)

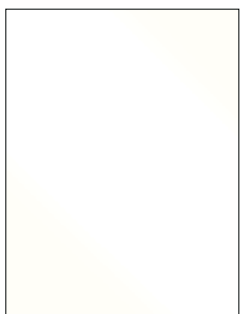

glaks bianco lucido
(opt.7492)

glaks white glossy
(opt.7492)



glaks rosa colorado lucido
(opt.8142)

glaks colorado pink glossy
(opt.8142)

elementi a giorno
open units

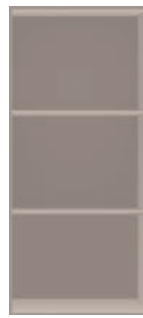

bruno antilope (opt.9451)

antelope brown (opt.9451)

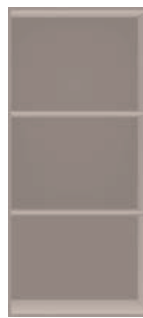

bruno antilope (opt.9451)

antelope brown (opt.9451)

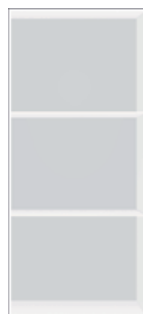

bianco assoluto (opt.740P)

absolute white (opt.740P)

top
worktops



top quarzo lucido
ashen light breeze (opt.T206)

quarzo worktop glossy
ashen light breeze (opt.T206)

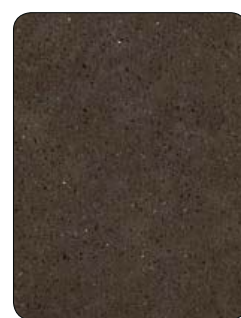

top light brown (opt.L003)

light worktop brown (opt.L003)

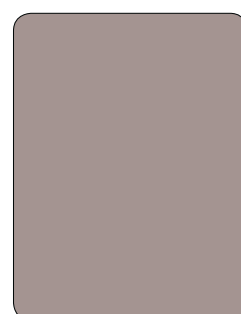

top laminato fenix
rosa colorado (opt.0716)

laminated fenix worktop
colorado pink (opt.0716)

consigli per abbinamento dei colori recommended colour combinations

ante doors



rovere naturale vintage
(opz.5310)
vintage natural oak
(opt.5310)

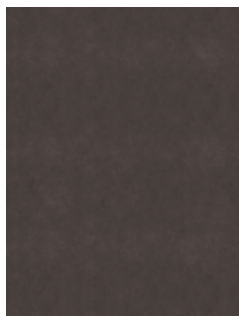

peltro (opz.9549)
pewter (opt.9549)



celeste alpaca lucido
(opz.8322)
glossy alpaca light blue
(opt.8322)

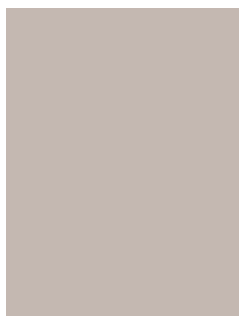

kaschmir opaco (opz.7713)
matt kaschmir (opt.7713)



rovere cipria spazzolato
(opz.5312)
brushed powder oak
(opt.5312)

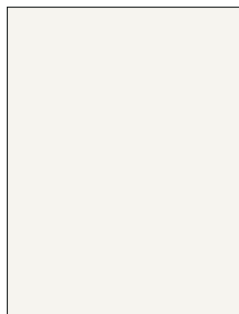

bianco caldo opaco (opz.7401)
matt warm white (opt.7401)

elementi a giorno open units



salvia (opz.8443)
sage green (opt.8443)

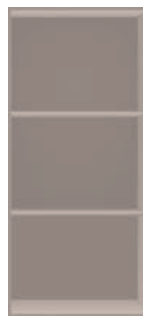

bruno antilope (opz.9451)
antelope brown (opt.9451)



salvia (opz.8443)
sage green (opt.8443)

top worktops



top laminato acciaio
invecchiato finitura velvet
(opz.5550)
laminare worktop aged steel
laminare with velvet finish
(opt.5550)



top quarzo lucido
ashen light breeze (opz.T206)
quarzo worktop glossy
ashen light breeze (opt.T206)

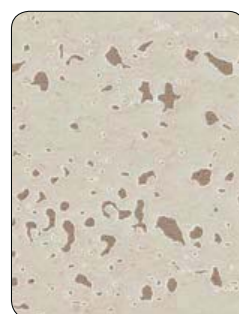

top laminato ABS1 travertino
beige finitura plamky
(opz.5548)
laminare ABS1 worktop beige
travertine with plamky finish
(opt.5548)

MODULARITÀ E COMPONIBILITÀ MODULARITY AND FITTING SOLUTIONS

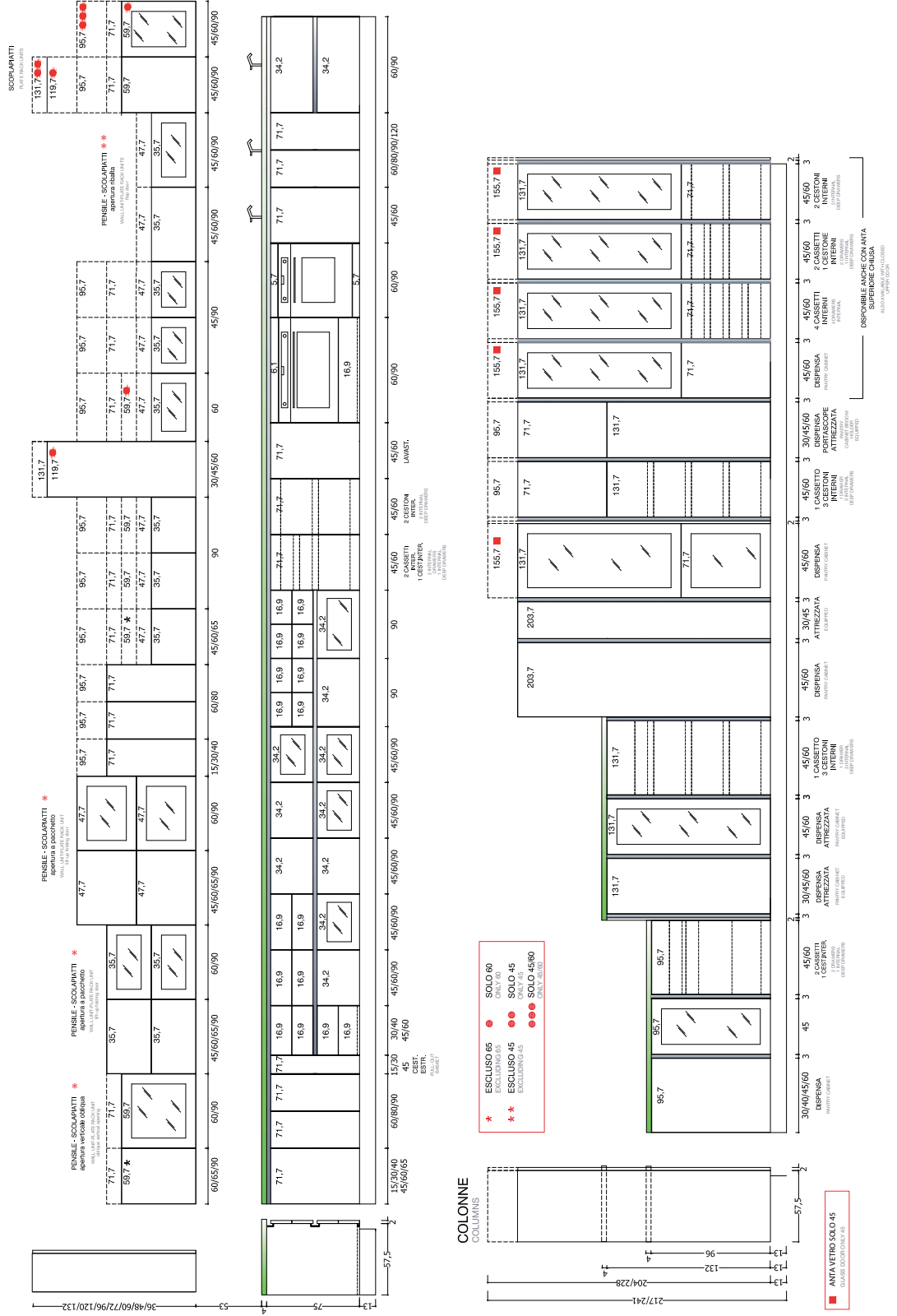

MODULARITÀ E COMPONIBILITÀ MODULARITY AND FITTING SOLUTIONS

BASI H 76 PER TOP H 12
BASE UNITS H 76 FOR TOP H 12

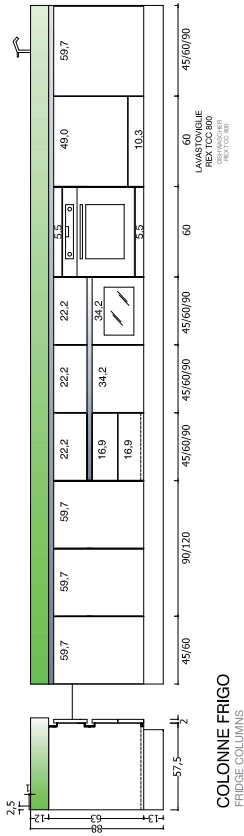

BASI LIVING CON ZOCCOLO
ROOM UNITS WITH PLINTH

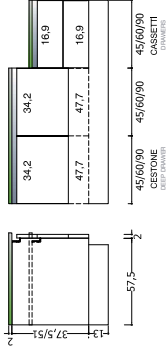

BASI LIVING CON PIEDINO CROMATO H 2
ROOM UNITS WITH FEET CHROME H 2

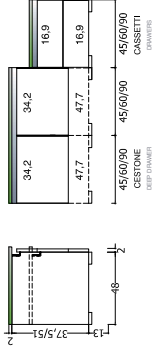

COLONNE FRIGO
FRIDGE COLUMNS

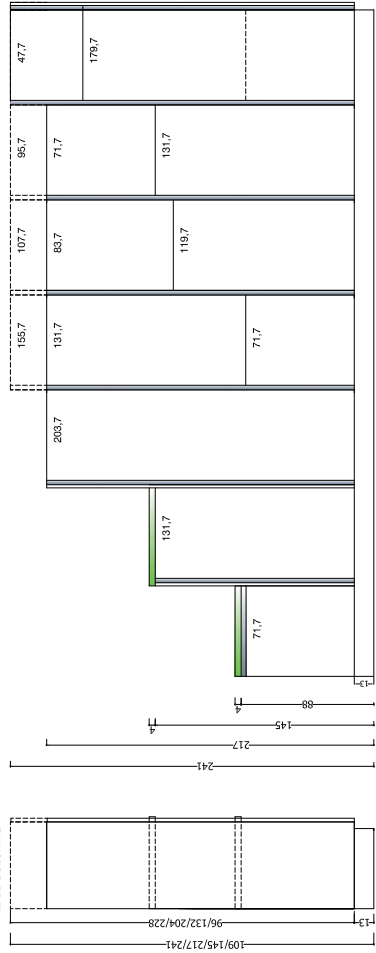

BASI SOSEPSE
HANGING BASE UNITS

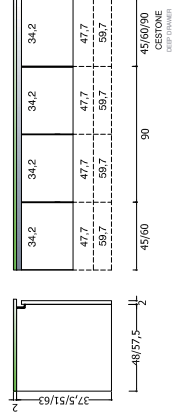

COLONNE FORNO
OVEN COLUMNS









PENSILI APERTURA CON PRESA SUL FONDO

P 33,2

WALL UNITS GRIP ON BOTTON OPENING

N.B.: cerniere ammortizzate di serie
Note: standard blumotion hinges

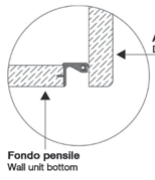
	COD.	MELA-MINICO	POLIMERICO		LACCATO			GLAKS	
		KG6	OPACO KG7	LUCIDO KG7	A KG8	B KG8	PELTRO KG8	KG3	
 <p>1 anta H 36 1 door H 36</p>	L 45	G2030451/2	88	93	98	95	104	117	140
	L 60	G2030601/2	97	103	110	107	120	137	155
	L 65	G2030651/2	110	117	123	121	134	153	180
 <p>1 anta H 48 1 door H 48</p>	L 45	G2040451/2	104	109	115	113	125	142	168
	L 60	G2040601/2	114	123	131	129	145	169	190
	L 65	G2040651/2	128	137	146	146	163	188	221
 <p>1 anta H 60 1 door H 60</p>	L 45	G2060451/2	109	118	126	124	139	161	181
	L 60	G2060601/2	122	134	144	145	165	194	207
 <p>1 anta H 72 1 door H 72</p>	L 15	G2010151/2	91	90	94	94	102	116	134
	L 30	G2010301/2	101	107	113	111	123	140	162
	L 40	G2010401/2	111	120	128	126	142	166	187
	L 45	G2010451/2	115	125	134	133	151	178	198
	L 60	G2010601/2	128	144	155	156	179	217	228
	L 65	G2010651/2	142	159	171	177	203	239	263
 <p>1 anta H 96 1 door H 96</p>	L 15	G2020151/2	103	104	109	109	119	126	150
	L 30	G2020301/2	119	127	135	134	149	173	190
	L 40	G2020401/2	131	143	154	155	177	207	226
	L 45	G2020451/2	136	151	162	163	187	224	242
	L 60	G2020601/2	157	179	193	197	229	279	288
	L 65	G2020651/2	171	196	211	220	255	304	331
 <p>1 anta H 120 1 door H 120</p>	L 60	G2145601/2	214	247	265	272	313	370	374
 <p>1 anta H 132 1 door H 132</p>	L 30	G2141301/2	180	192	203	206	229	258	289
	L 45	G2141451/2	200	223	238	246	280	325	351
	L 60	G2141601/2	225	257	276	285	328	397	409
 <p>Apertura senza maniglia, presa sul fondo Grip on bottom opening, without handle</p> <p>Anta Door</p> <p>Fondo pensile Wall unit bottom</p>									

PENSILI APERTURA CON PRESA SUL FONDO

P 33,2

WALL UNITS GRIP ON BOTTON OPENING

N.B.: cerniere ammortizzate di serie
Note: standard blumotion hinges





	COD.	MELA-MINICO	POLIMERICO		LACCATO			GLAKS	
		KG6	OPACO KG7	LUCIDO KG7	A KG8	B KG8	PELTRO KG8	KG3	
 <p>2 ante H 36 2 doors H 36</p>	L 90	G2030900	140	149	159	153	171	196	243
	L 90	G2040900	165	176	188	183	207	242	295
 <p>2 ante H 48 2 doors H 48</p>	L 90	G2060900	172	192	207	203	233	278	317
	L 60	G2010600	156	168	181	175	200	234	279
 <p>2 ante H 72 2 doors H 72</p>	L 80	G2010800	176	194	210	207	239	287	329
	L 90	G2010900	184	206	224	222	257	312	351
	L 60	G2020600	185	201	217	214	246	293	327
 <p>2 ante H 96 2 doors H 96</p>	L 80	G2020800	209	234	255	258	301	362	399
	L 90	G2020900	220	250	273	274	321	396	431
	H 72 L 15	G2010150	150	151	154	153	161	175	193
 <p>cestello estraibile chiusura soft pull-out basket unit soft-closing system</p>	H 96 L 15	G2020150	174	175	180	180	190	196	221
	H 60	G2790000	50	62	70	88	109	114	107
 <p>fascia tamponamento L da 3 a 10 filler panel size from 3 to 10</p>	H 72	G2800000	50	62	70	88	109	114	107
	H 96	G2810000	56	80	89	113	138	143	131
	<p>Maggiorazione per apertura Push Pull Surcharge for opening Push Pull</p>								
<p>Push Pull (Opz.996) 1 ante Push Pull (code 996) 1 door</p>			+ 10	+ 10	+ 10	+ 10	+ 10	+ 10	+ 10
<p>Push Pull (Opz.996) 2 ante Push Pull (code 996) 2 doors</p>			+ 20	+ 20	+ 20	+ 20	+ 20	+ 20	+ 20

PENSILI APERTURA CON PRESA SUL FONDO

P 33,2

WALL UNITS GRIP ON BOTTON OPENING

N.B.: cerniere ammortizzate di serie
Note: standard blumotion hinges





	COD.	MELAMINICO	POLIMERICICO		LACCATO			GLAKS	
		KG6	OPACO KG7	LUCIDO KG7	A KG8	B KG8	PELTRO KG8	KG3	
 <p>1 anta vetro H 36 1 glass door H 36</p>									
	telaio peltro-polimerico L 45 pewter-polymeric frame	G1030451/2	176	158	160	176	176	176	—
	L 60	G1030601/2	213	170	171	213	213	213	—
	telaio alluminio 419S L 45 aluminium frame	G1032451/2	175	175	175	175	175	175	—
L 60	G1032601/2	199	199	199	199	199	199	—	
 <p>1 anta vetro H 48 1 glass door H 48</p>									
	telaio peltro-polimerico L 45 pewter-polymeric frame	G1040451/2	208	178	179	208	208	208	—
	L 60	G1040601/2	255	202	205	255	255	255	—
	telaio alluminio 419S L 45 aluminium frame	G1042451/2	198	198	198	198	198	198	—
L 60	G1042601/2	221	221	221	221	221	221	—	
 <p>1 anta vetro H 60 1 glass door H 60</p>									
	telaio peltro-polimerico L 60 pewter-polymeric frame	G1060601/2	270	213	218	270	270	270	—
telaio alluminio 419S L 60 aluminium frame	G1062601/2	231	231	231	231	231	231	—	
 <p>1 anta vetro H 72 1 glass door H 72</p>									
	telaio peltro-polimerico L 45 pewter-polymeric frame	G1010451/2	255	194	198	255	255	255	—
	L 60	G1010601/2	309	228	235	309	309	309	—
	telaio alluminio 419S L 45 aluminium frame	G1012451/2	219	219	219	219	219	219	—
L 60	G1012601/2	247	247	247	247	247	247	—	
 <p>1 anta vetro H 96 1 glass door H 96</p>									
	telaio peltro-polimerico L 45 pewter-polymeric frame	G1020451/2	320	232	239	320	320	320	—
	telaio alluminio 419S L 45 aluminium frame	G1022451/2	259	259	259	259	259	259	—
L 60	G1022601/2	296	296	296	296	296	296	—	

PENSILI APERTURA CON PRESA SUL FONDO

P 33,2

WALL UNITS GRIP ON BOTTON OPENING

N.B.: cerniere ammortizzate di serie
Note: standard blumotion hinges

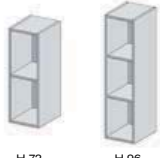



	COD.	MELA- MINICO	POLIMERICO		LACCATO			GLAKS
		KG6	OPACO KG7	LUCIDO KG7	A KG8	B KG8	PELTRO KG8	KG3
2 ante vetro H 36 2 glass doors H 36 								
	telaio peltro-polimerico L 90 pewter-polymeric frame telaio alluminio 419S L 90 aluminium frame	G1030900	312	277	279	312	312	312
2 ante vetro H 48 2 glass doors H 48 								
	telaio peltro-polimerico L 90 pewter-polymeric frame telaio alluminio 419S L 90 aluminium frame	G1040900	369	309	311	368	368	368
2 ante vetro H 72 2 glass doors H 72 								
	telaio peltro-polimerico L 90 pewter-polymeric frame telaio alluminio 419S L 90 aluminium frame	G1010900	465	344	352	465	465	465
2 ante vetro H 96 2 glass doors H 96 								
	telaio peltro-polimerico L 90 pewter-polymeric frame telaio alluminio 419S L 90 aluminium frame	G1020900	588	411	425	588	588	588
jolly pensile H 72 L da 10 a 30 colore come struttura jolly wall unit size 10 to 30 same colour as carcass 								
	in nobilitato melamine coated							
	H 72	G2700000	53	53	53	53	53	53
H 96	G2710000	61	61	61	61	61	61	61

PENSILI APERTURA CON PRESA SUL FONDO

P 33,2 - 47,2 - 59,7

WALL UNITS GRIP ON BOTTON OPENING

N.B.: cerniere ammortizzate di serie
Note: standard blumotion hinges

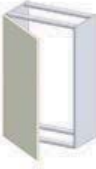





	COD.	MELAMINICO	POLIMERICO		LACCATO			GLAKS	
		KG6	OPACO KG7	LUCIDO KG7	A KG8	B KG8	PELTRO KG8	KG3	
 <p>angolo H 72 1 anta diagonale corner unit H 72 1 diagonal door</p>	65X65	G2400651/2	186	197	206	205	223	250	270
	 <p>angolo H 96 1 anta diagonale corner unit H 96 1 diagonal door</p>	65X65	G2410651/2	218	233	244	245	268	305
 <p>angolo H 72 2 ante a libretto N.B.: fuori squadra realizzabili da 88° a 92° corner unit H 72 2 folding doors Note: out-of-plumb units available from 88° to 92°</p>		65X65	G2450651/2	235	245	258	254	280	317
	 <p>angolo H 96 2 ante a libretto N.B.: fuori squadra realizzabili da 88° a 92° corner unit H 96 2 folding doors Note: out-of-plumb units available from 88° to 92°</p>	65X65	G2460651/2	285	303	320	319	353	403
 <p>copriboiler H 72 1 anta boiler housing H 72 1 door</p>		L 60 P 33,2	G2150601/2	119	137	149	150	175	215
	L 60 P 47,2	G2160601/2	154	172	184	185	212	254	266
	L 60 P 59,7	G2170601/2	154	172	184	185	212	254	266
 <p>copriboiler H 96 1 anta boiler housing H 96 1 door</p>	L 60 P 33,2	G2210601/2	141	164	180	184	218	271	281
	L 60 P 47,2	G2220601/2	184	209	225	229	264	320	331
	L 60 P 59,7	G2230601/2	184	209	225	229	264	320	331

PENSILI RIBALTA CHIUSURA AMMORTIZZATA

P 33,2

FLAP DOOR WALL UNITS BLUMOTION CLOSING SYSTEM

N.B.: sovrapponibili solo con le ribalte tip-on
 Note: overlapping only with tip-on flap doors

	COD.	MELAMINICO	POLIMERICO		LACCATO			GLAKS	
		KG6	OPACO KG7	LUCIDO KG7	A KG8	B KG8	PELTRO KG8	KG3	
anta ribalta H 36 flap door H 36 	L 45	G2100450	114	119	124	121	130	143	168
	L 60	G2100600	119	125	132	129	142	159	177
	L 65	G2100650	134	141	148	145	158	177	205
	L 90	G2100900	150	160	168	168	186	212	229
anta vetro ribalta H 36 glass flap door H 36 									
anta vetro ribalta H 36 glass flap door H 36 									
anta ribalta H 48 flap door H 48 									
anta ribalta H 48 flap door H 48 									
anta vetro ribalta H 48 glass flap door H 48 									
anta vetro ribalta H 48 glass flap door H 48 									

PENSILI A RIBALTA SENZA MANIGLIA APERTURA TIP-ON



FLAP DOOR WALL UNITS NO HANDLE TIP-ON OPENING

P 33,2



Grazie al meccanismo TIP-ON, le ante a ribalta senza maniglia possono essere aperte semplicemente con un leggero tocco. Per chiudere l'anta a ribalta, è sufficiente esercitare una leggera pressione, che grazie ad una piastrina di bloccaggio, applicata sul lato interno del frontale, ne assicura la perfetta chiusura.





Thanks to TIP-ON mechanism, the flap doors without handles can be opened with a simple touch. To close the flap door, just exercise light pressure, thanks to the locking plate, applied on the inner side of the front panel ensures a perfect closure.

	COD.	MELA-MINICO	POLIMERICO		LACCATO			GLAKS	
		KG6	OPACO KG7	LUCIDO KG7	A KG8	B KG8	PELTRO KG8	KG3	
anta ribalta TIP-ON H 36 flap door TIP-ON H 36 	L 45	G210046T	110	115	120	117	126	139	164
	L 60	G210061T	115	121	128	126	138	156	173
	L 65	G210066T	130	137	144	141	154	173	201
	L 90	G210091T	146	156	164	164	182	209	225
anta ribalta TIP-ON H 48 flap door TIP-ON H 48 	L 45	G212046T	138	144	150	147	160	178	205
	L 60	G212061T	156	165	173	172	188	212	233
	L 65	G212066T	173	182	191	191	208	233	266
	L 90	G212091T	179	194	205	207	231	267	286

PENSILI APERTURA VERTICALE OBLIQUA CHIUSURA BLUMOTION

P 33,2

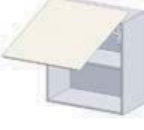



WALL UNITS VERTICAL OBLIQUE OPENING AND BLUMOTION CLOSING SYSTEM

	COD.	MELAMINICO	POLIMERICO		LACCATO			GLAKS	
		KG6	OPACO KG7	LUCIDO KG7	A KG8	B KG8	PELTRO KG8	KG3	
anta apertura verticale obliqua H 60 door with oblique vertical opening H 60 	L 60	G2135600	291	310	320	313	334	363	375
	L 90	G2135900	318	349	362	361	392	435	445
anta vetro apertura verticale obliqua H 60 glass door with oblique vertical opening H 60 									
	telaio petro-polimerico L 60 pewter-polymeric frame	G1205600	434	381	388	434	434	434	—
	L 90	G1205900	571	431	446	571	571	571	—
	telaio alluminio 419S L 60 aluminium frame	G1207600	444	444	444	444	444	444	—
	L 90	G1207900	503	503	503	503	503	503	—
anta apertura verticale obliqua H 72 door with oblique vertical opening H 72 	L 60	G2130600	302	326	337	330	354	392	402
	L 65	G2130650	317	341	353	351	377	413	437
	L 90	G2130900	329	363	379	379	414	469	477
anta vetro apertura verticale obliqua H 72 glass door with oblique vertical opening H 72 									
	telaio petro-polimerico L 60 pewter-polymeric frame	G1200600	483	396	408	483	483	483	—
	L 90	G1200900	630	453	471	630	630	630	—
	telaio alluminio 419S L 60 aluminium frame	G1202600	465	465	465	465	465	465	—
	L 90	G1202900	525	525	525	525	525	525	—

PENSILI APERTURA A PACCHETTO

P 33,2





WALL UNITS FOLDING DOORS

	COD.	MELA-MINICO	POLIMERICO		LACCATO			GLAKS	
		KG6	OPACO KG7	LUCIDO KG7	A KG8	B KG8	PELTRO KG8	KG3	
 <p>pensile H 72 apertura a pacchetto 2 ante H 36 wall unit H 72 lift-up folding door 2 doors H 36</p>	L 45	G2070450	296	310	320	309	328	353	400
	L 60	G2070600	312	328	340	332	356	391	427
	L 65	G2070650	325	346	359	348	374	412	467
	L 90	G2070900	347	370	388	383	419	472	505
 <p>pensile H 72 apertura a pacchetto 2 ante vetro H 36 wall unit H 72 lift-up folding door 2 glass doors H 36</p>									
	telaio peltro-polimerico L 60 pewter-polymeric frame	G1070600	526	451	461	526	526	526	—
	L 90	G1070900	638	500	514	637	638	638	—
	telaio alluminio 419S L 45 aluminium frame	G1075450	491	491	491	491	491	491	—
	L 60	G1075600	523	523	523	523	523	523	—
L 90	G1075900	599	599	599	599	599	599	—	
 <p>pensile H 72 apertura a pacchetto 1 anta chiusa superiore H 36 1 anta vetro inferiore H 36 wall unit H 72 lift-up folding door 1 full upper door H 36 1 glass lower door H 36</p>									
	telaio peltro-polimerico L 60 pewter-polymeric frame	G2075600	419	389	400	429	441	458	—
	L 90	G2075900	492	435	451	510	528	555	—
	telaio alluminio 419S L 45 aluminium frame	G2085450	384	388	393	390	399	412	—
	L 60	G2085600	408	414	420	418	430	447	—
L 90	G2085900	462	471	480	479	497	524	—	
 <p>pensile H 72 apertura a pacchetto 1 anta vetro superiore H 36 1 anta chiusa inferiore H 36 wall unit H 72 lift-up folding door 1 glass upper door H 36 1 full lower door H 36</p>									
	telaio peltro-polimerico L 60 pewter-polymeric frame	G2077600	419	389	400	429	441	458	—
	L 90	G2077900	492	435	451	510	528	555	—
	telaio alluminio 419S L 45 aluminium frame	G2087450	384	388	393	390	399	412	—
	L 60	G2087600	408	414	420	418	430	447	—
L 90	G2087900	462	471	480	479	497	524	—	

PENSILI APERTURA A PACCHETTO

P 33,2

WALL UNITS FOLDING DOORS

	COD.	MELAMINICO	POLIMERICO		LACCATO			GLAKS	
		KG6	OPACO KG7	LUCIDO KG7	A KG8	B KG8	PELTRO KG8	KG3	
 <p>pensile H 96 apertura a pacchetto 2 ante H 48 wall unit H 96 lift-up folding door 2 doors H 48</p>	L 45	G2090450	333	351	363	352	376	411	463
	L 60	G2090600	350	375	390	381	412	461	502
	L 65	G2090650	367	391	408	401	436	487	552
	L 90	G2090900	393	429	451	449	497	569	606
 <p>pensile H 96 apertura a pacchetto 2 ante vetro H 48 wall unit H 96 lift-up folding door 2 glass doors H 48</p>									
	telaio petro-polimerico L 60 pewter-polymeric frame	G1090600	609	510	517	609	609	609	—
	L 90	G1090900	750	581	606	750	750	750	—
	telaio alluminio 419S L 60 aluminium frame	G1095600	584	584	584	584	584	584	—
	L 90	G1095900	673	673	673	673	673	673	—
 <p>pensile H 96 apertura a pacchetto 1 anta chiusa superiore H 48 1 anta vetro inferiore H 48 wall unit H 96 lift-up folding door 1 full upper door H 48 1 glass lower door H 48</p>									
	telaio petro-polimerico L 60 pewter-polymeric frame	G2092600	480	440	448	495	511	535	—
	L 90	G2092900	571	502	526	600	624	659	—
	telaio alluminio 419S L 60 aluminium frame	G2097600	458	467	474	473	489	513	—
	L 90	G2097900	521	536	547	549	573	609	—
 <p>pensile H 96 apertura a pacchetto 1 anta vetro superiore H 48 1 anta chiusa inferiore H 48 wall unit H 96 lift-up folding door 1 glass upper door H 48 1 full lower door H 48</p>									
	telaio petro-polimerico L 60 pewter-polymeric frame	G2096600	480	440	448	495	511	535	—
	L 90	G2096900	571	502	526	600	624	659	—
	telaio alluminio 419S L 60 aluminium frame	G2098600	458	467	474	473	489	513	—
	L 90	G2098900	521	536	547	549	573	609	—

PENSILI PER MICRO

P 33,2

WALL UNITS FOR MICROWAVE OVENS

N.B.: cerniere ammortizzate di serie
 Note: standard blumotion hinges

COD.

MELA-
MINICO
KG6

POLIMERICO
OPACO
KG7

LUCIDO
KG7

LACCATO
A
KG8

B
KG8

PELTRO
KG8

GLAKS
KG3

pensile H 72
1 anta ribalta H 36 apertura TIP-ON
vano per micro Whirlpool
 wall unit H 72
 1 flap door H 36 TIP-ON opening
 housing for Whirlpool microwave



L 60

GPM20600

150

156

162

160

172

189

208

pensile H 96
1 anta H 60 apertura push-pull
vano per micro Whirlpool
 wall unit H 96
 1 door H 60 push-pull opening
 housing for Whirlpool microwave

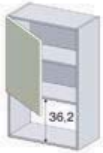

L 60

GPM25601/2

165

177

187

188

208

237





250

SOPRAPENSILI APERTURA PUSH-PULL (OPZ.996)

P 59,7

TOP UNITS PUSH-PULL OPENING (CODE.996)







N.B.: cerniere ammortizzate di serie
Note: standard blumotion hinges

	COD.	MELA-MINICO	POLIMERICO		LACCATO			GLAKS	
		KG6	OPACO KG7	LUCIDO KG7	A KG8	B KG8	PELTRO KG8	KG3	
 <p>soprapensile H 36 1 anta top unit H 36 1 door</p>	L 45	G2063451/2	137	142	147	144	153	165	189
	L 60	G2063601/2	165	171	177	175	187	204	223
 <p>soprapensile H 48 1 anta top unit H 48 1 door</p>	L 45	G2064451/2	173	179	185	183	195	212	238
	L 60	G2064601/2	203	213	220	219	235	259	280
 <p>soprapensile H 60 1 anta top unit H 60 1 door</p>	L 45	G2065451/2	174	183	191	189	204	226	246
	L 60	G2065601/2	207	219	229	230	250	279	292
 <p>soprapensile H 36 2 ante top unit H 36 2 doors</p>	L 90	G2063900	195	204	214	208	226	251	298
 <p>soprapensile H 48 2 ante top unit H 48 2 doors</p>	L 90	G2064900	259	270	282	277	301	336	389
 <p>soprapensile H 60 2 ante top unit H 60 2 doors</p>	L 90	G2065900	261	280	295	291	321	366	406

SCOLAPIATTI GRIGLIE INOX

PLATE RACK UNITS INOX GRILLES

P 33,2

	COD.	MELA-MINICO	POLIMERICICO		LACCATO			GLAKS		
		KG6	OPACO KG7	LUCIDO KG7	A KG8	B KG8	PELTRO KG8	KG3		
 <p>1 anta H 60 1 door H 60</p>	L 45	G3060451/2	124	134	142	140	155	177	197	
	L 60	G3060601/2	137	149	158	159	179	208	221	
				+84	+84	+84	+84	+84	+84	+84
 <p>1 anta H 72 1 door H 72</p>	L 45	G3010451/2	130	141	150	149	166	194	214	
	L 60	G3010601/2	141	158	169	170	193	231	241	
				+84	+84	+84	+84	+84	+84	+84
 <p>1 anta H 96 1 door H 96</p>	L 45	G3020451/2	152	167	178	179	202	240	257	
	L 60	G3020601/2	175	197	211	215	247	297	306	
				+84	+84	+84	+84	+84	+84	+84
 <p>1 anta H 120 - 132 1 door H 120 - 132</p>	H 120 L 60	G3067601/2	220	251	267	279	320	376	381	
	H 132 L 45	G3068451/2	219	241	257	265	299	344	369	
	H 132 L 60	G3068601/2	239	272	291	299	343	411	424	
				+84	+84	+84	+84	+84	+84	+84
 <p>1 anta vetro H 60 1 glass door H 60</p>	telaio peltro-polimerico L 60 pewter-polymeric frame	G3260601/2	278	221	226	278	278	278	—	
	telaio alluminio 419S L 60 aluminium frame	G3262601/2	242	242	242	242	242	242	—	
				+84	+84	+84	+84	+84	+84	—
 <p>1 anta vetro H 72 1 glass door H 72</p>	telaio peltro-polimerico L 45 pewter-polymeric frame	G3210451/2	270	201	214	270	270	270	—	
	L 60	G3210601/2	323	232	248	323	323	323	—	
	telaio alluminio 419S L 45 aluminium frame	G3212451/2	234	234	234	234	234	234	—	
	L 60	G3212601/2	258	258	258	258	258	258	—	
				+84	+84	+84	+84	+84	+84	—
 <p>1 anta vetro H 96 1 glass door H 96</p>	telaio peltro-polimerico L 45 pewter-polymeric frame	G3220451/2	336	238	254	336	336	336	—	
	telaio alluminio 419S L 45 aluminium frame	G3222451/2	273	273	273	273	273	273	—	
	L 60	G3222601/2	311	311	311	311	311	311	—	
				+84	+84	+84	+84	+84	+84	—

SCOLAPIATTI GRIGLIE INOX

PLATE RACK UNITS INOX GRILLES

P 33,2





N.B.: cerniere ammortizzate di serie
Note: standard blumotion hinges

	COD.	MELA-	POLIMERICO		LACCATO			GLAKS	
		MINICO	OPACO	LUCIDO	A	B	PELTRO	KG3	
		KG6	KG7	KG7	KG8	KG8	KG8	KG3	
 <p>2 ante H 60 2 doors H 60</p>	L 90	G3060900	197	216	231	228	257	303	342
			+84	+84	+84	+84	+84	+84	+84
 <p>2 ante H 72 2 doors H 72</p>	L 60	G3010600	179	191	204	198	223	257	302
	L 80	G3010800	202	220	235	233	264	312	354
	L 90	G3010900	221	233	250	248	284	339	378
			+84	+84	+84	+84	+84	+84	+84
 <p>2 ante H 96 2 doors H 96</p>	L 60	G3020600	207	223	239	236	268	315	349
	L 80	G3020800	233	258	279	282	325	386	422
	L 90	G3020900	246	275	298	300	347	421	457
			+84	+84	+84	+84	+84	+84	+84
 <p>2 ante vetro H 72 2 glass doors H 72</p>									
	telaio peltro-polimerico L 90 pewter-polymeric frame	G3210900	492	352	379	492	492	492	—
	telaio alluminio 419S L 90 aluminium frame	G3212900	417	417	417	417	417	417	—
			+84	+84	+84	+84	+84	+84	—
 <p>2 ante vetro H 96 2 glass doors H 96</p>									
	telaio peltro-polimerico L 90 pewter-polymeric frame	G3220900	613	418	450	613	613	613	—
	telaio alluminio 419S L 90 aluminium frame	G3222900	486	486	486	486	486	486	—
			+84	+84	+84	+84	+84	+84	—
 <p>angolo H 72 2 ante a libretto N.B.: non si effettuano fuori squadra corner unit H 72 2 folding doors Note: out-of-plumb units unavailable</p>	65X65	G3450651/2	338	348	361	357	383	420	459
 <p>angolo H 96 2 ante a libretto N.B.: non si effettuano fuori squadra corner unit H 96 2 folding doors Note: out-of-plumb units unavailable</p>	65X65	G3460651/2	393	411	428	427	461	510	540

SCOLAPIATTI RIBALTA CHIUSURA AMMORTIZZATA GRIGLIE INOX

P 33,2





FLAP-DOOR PLATE RACK UNITS BLUMOTION CLOSING SYSTEM AND INOX GRILLES

	COD.	MELA-MINICO	POLIMERICO		LACCATO			GLAKS	
		KG6	OPACO KG7	LUCIDO KG7	A KG8	B KG8	PELTRO KG8	KG3	
anta ribalta H 36 flap door H 36 	L 60	G3100600	128	136	142	138	150	167	186
	L 90	G3100900	164	177	186	182	200	227	243
			+84	+84	+84	+84	+84	+84	+84
anta ribalta H 48 flap door H 48 	L 60	G3120600	160	169	177	175	191	215	236
	L 90	G3120900	186	201	212	214	238	274	293
			+84	+84	+84	+84	+84	+84	+84
anta vetro ribalta H 36 glass flap door H 36 	telaio pettro-polimerico L 60 pewter-polymeric frame	G3130600	236	197	202	236	236	236	—
	L 90	G3130900	310	241	248	310	310	310	—
	telaio alluminio 419S L 60 aluminium frame	G3132600	214	214	214	214	214	214	—
	L 90	G3132900	271	271	271	271	271	271	—
			+84	+84	+84	+84	+84	+84	—
anta vetro ribalta H 48 glass flap door H 48 	telaio pettro-polimerico L 60 pewter-polymeric frame	G3140600	291	234	242	291	291	291	—
	L 90	G3140900	366	282	294	366	366	366	—
	telaio alluminio 419S L 60 aluminium frame	G3142600	258	258	258	258	258	258	—
	L 90	G3142900	305	305	305	305	305	305	—
			+84	+84	+84	+84	+84	+84	—

SCOLAPIATTI APERTURA VERTICALE OBLIQUA CHIUSURA BLUMOTION

P 33,2





PLATE RACK UNITS VERTICAL OBLIQUE OPENING AND BLUMOTION CLOSING SYSTEM

	COD.	MELAMINICO	POLIMERICO		LACCATO			GLAKS	
		KG6	OPACO KG7	LUCIDO KG7	A KG8	B KG8	PELTRO KG8	KG3	
<p>anta apertura verticale obliqua H 60 griglie inox e raccogligocce inox door with vertical oblique opening H 60 inox grilles and stainless steel drip tray</p> 	L 60	G3123600	303	317	326	326	346	375	388
	L 90	G3123900	340	364	377	384	414	457	468
			+84	+84	+84	+84	+84	+84	+84
<p>anta vetro apertura verticale obliqua H 60 griglie inox e raccogligocce inox glass door with vertical oblique opening H 60 inox grilles and stainless steel drip tray</p> 									
	telaio petro-polimerico L 60 pewter-polymeric frame	G3205600	445	385	393	445	445	445	—
	L 90	G3205900	593	454	469	593	593	593	—
	telaio alluminio 419S L 60 aluminium frame	G3207600	442	442	442	442	442	442	—
	L 90	G3207900	514	514	514	514	514	514	—
			+84	+84	+84	+84	+84	+84	—
<p>anta apertura verticale obliqua H 72 griglie inox e raccogligocce inox door with vertical oblique opening H 72 inox grilles and stainless steel drip tray</p> 	L 60	G3125600	313	330	341	341	364	402	412
	L 90	G3125900	349	376	392	399	434	489	497
			+84	+84	+84	+84	+84	+84	+84
<p>anta vetro apertura verticale obliqua H 72 griglie inox e raccogligocce inox glass door with vertical oblique opening H 72 inox grilles and stainless steel drip tray</p> 									
	telaio petro-polimerico L 60 pewter-polymeric frame	G3200600	494	407	419	494	494	494	—
	L 90	G3200900	652	474	493	652	652	652	—
	telaio alluminio 419S L 60 aluminium frame	G3202600	461	461	461	461	461	461	—
	L 90	G3202900	523	523	523	523	523	523	—
			+84	+84	+84	+84	+84	+84	—

SCOLAPIATTI APERTURA A PACCHETTO CHIUSURA BLUMOTION

P 33,2





PLATE RACK UNITS LIFT-UP FOLDING DOORS AND BLUMOTION CLOSING SYSTEM

	COD.	MELAMINICO	POLIMERICO		LACCATO			GLAKS		
		KG6	OPACO KG7	LUCIDO KG7	A KG8	B KG8	PELTRO KG8	KG3		
 <p>scolapiatti H 72 apertura a pacchetto 2 ante H 36 griglie inox plate rack unit H 72 lift-up folding door 2 doors H 36 inox grilles</p>	L 45	G3081450	303	316	325	316	334	359	406	
	L 60	G3081600	316	331	343	336	361	395	432	
	L 90	G3081900	355	377	394	391	427	480	513	
	mag.griglie con luce led surcharge grilles with led light			+84	+84	+84	+84	+84	+84	+84
 <p>scolapiatti H 72 apertura a pacchetto 2 ante vetro H 36 griglie inox plate rack unit H 72 lift-up folding door 2 glass doors H 36 inox grilles</p>	telaio peltro-polimerico L 60 pewter-polymeric frame	G3270600	530	454	464	530	530	530	—	
	L 90	G3270900	645	506	521	645	645	645	—	
	telaio alluminio 419S L 45 aluminium frame	G3275450	501	501	501	501	501	501	—	
	L 60	G3275600	530	530	530	530	530	530	—	
	L 90	G3275900	605	605	605	605	605	605	—	
	mag.griglie con luce led surcharge grilles with led light			+84	+84	+84	+84	+84	+84	—
 <p>scolapiatti H 72 apertura a pacchetto 1 anta chiusa superiore H 36 1 anta vetro inferiore H 36 griglie inox plate rack unit H 72 lift-up folding door 1 full upper door H 36 1 glass lower door H 36 inox grilles</p>	telaio peltro-polimerico L 60 pewter-polymeric frame	G3085600	423	392	403	433	445	462	—	
	L 90	G3085900	500	442	457	518	536	563	—	
	telaio alluminio 419S L 45 aluminium frame	G3075450	394	398	403	400	409	422	—	
	L 60	G3075600	416	422	429	426	439	456	—	
	L 90	G3075900	470	479	488	487	505	532	—	
	mag.griglie con luce led surcharge grilles with led light			+84	+84	+84	+84	+84	+84	—
 <p>scolapiatti H 72 apertura a pacchetto 1 anta vetro superiore H 36 1 anta chiusa inferiore H 36 griglie inox plate rack unit H 72 lift-up folding door 1 glass upper door H 36 1 full lower door H 36 inox grilles</p>	telaio peltro-polimerico L 60 pewter-polymeric frame	G3087600	423	392	403	433	445	462	—	
	L 90	G3087900	500	442	457	518	536	563	—	
	telaio alluminio 419S L 45 aluminium frame	G3077450	394	398	403	400	409	422	—	
	L 60	G3077600	416	422	429	426	439	456	—	
	L 90	G3077900	470	479	488	487	505	532	—	
	mag.griglie con luce led surcharge grilles with led light			+84	+84	+84	+84	+84	+84	—

SCOLAPIATTI APERTURA A PACCHETTO CHIUSURA BLUMOTION

P 33,2

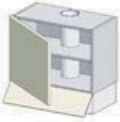



PLATE RACK UNITS LIFT-UP FOLDING DOORS AND BLUMOTION CLOSING SYSTEM

	COD.	MELAMINICO	POLIMERICO		LACCATO			GLAKS		
		KG6	OPACO KG7	LUCIDO KG7	A KG8	B KG8	PELTRO KG8	KG3		
 <p>scolapiatti H 96 apertura a pacchetto 2 ante H 48 griglie inox plate rack unit H 96 lift-up folding door 2 doors H 48 inox grilles</p>	L 45	G3094450	340	357	369	358	382	417	462	
	L 60	G3094600	354	377	393	385	417	465	507	
	L 90	G3094900	401	436	458	457	505	577	614	
				+84	+84	+84	+84	+84	+84	+84
 <p>scolapiatti H 96 apertura a pacchetto 2 ante vetro H 48 griglie inox plate rack unit H 96 lift-up folding door 2 glass doors H 48 inox grilles</p>										
 <p>scolapiatti H 96 apertura a pacchetto 1 anta chiusa superiore H 48 1 anta vetro inferiore H 48 griglie inox plate rack unit H 96 lift-up folding door 1 full upper door H 48 1 glass lower door H 48 inox grilles</p>										
 <p>scolapiatti H 96 apertura a pacchetto 1 anta vetro superiore H 48 1 anta chiusa inferiore H 48 griglie inox plate rack unit H 96 lift-up folding door 1 glass upper door H 48 1 full lower door H 48 inox grilles</p>										

CAPPE ASPIRANTI

EXTRACTOR HOODS

P 33,2

	COD.	MELA-MINICO	POLIMERICO		LACCATO			GLAKS	
		KG6	OPACO KG7	LUCIDO KG7	A KG8	B KG8	PELTRO KG8	KG3	
<p>cappa estraibile 1 motore portata 160 m³/h con laterali in metallo, 1 anta apertura push-pull</p> <p>N.B. : posizionare la cappa ad una distanza non inferiore ai 65 cm dal piano cottura</p>  <p>slide-out hood 1 motor air flow rate 160 m³/h with metal sides, 1 door push-pull opening</p> <p>Note: position the hood at least 65 cm from the cooker hob</p>	H 63 L 60	G3600601/2	204	217	229	222	245	286	319
	H 87 L 60	G3610601/2	221	241	256	251	282	336	359
	n° 1 filtro carbone attivo 1 active carbon filter		+12	+12	+12	+12	+12	+12	+12
	maggiorazione 2 motori portata 235 m³/h surcharge 2 motors air flow rate 235 m³/h		+30	+30	+30	+30	+30	+30	+30
	n° 2 filtri carbone attivo 2 active carbon filters		+24	+24	+24	+24	+24	+24	+24
<p>cappa estraibile 1 motore portata 160 m³/h con laterali in metallo, 2 ante apertura push-pull</p> <p>N.B. : posizionare la cappa ad una distanza non inferiore ai 65 cm dal piano cottura</p>  <p>slide-out hood 1 motor air flow rate 160 m³/h with metal sides, 2 doors push-pull opening</p> <p>Note: position the hood at least 65 cm from the cooker hob</p>	H 63 L 90	G3600900	264	280	299	289	324	366	449
	H 87 L 90	G3610900	286	313	335	330	376	438	504
	n° 1 filtro carbone attivo 1 active carbon filter		+12	+12	+12	+12	+12	+12	+12
	maggiorazione 2 motori portata 235 m³/h surcharge 2 motors air flow rate 235 m³/h		+30	+30	+30	+30	+30	+30	+30
	n° 2 filtri carbone attivo 2 active carbon filters		+24	+24	+24	+24	+24	+24	+24
<p>cappa "Mod. F" integrata totale con frontalino vetro estraibile portata 415 m³/h con faretti a led 1 anta</p> <p>N.B.: posizionare la cappa ad una distanza non inferiore ai 55 cm dal piano cottura</p>  <p>"Mod. F" fully integrated hood with glass pull-out frontal panel air flow rate 415 m³/h, with led lights 1 door</p> <p>Note: position the hood at least 55 cm from the cooker hob</p>	H 60 L 60	GPC90461/2	458	470	479	480	501	529	542
	H 72 L 60	GPC90561/2	462	478	489	490	515	551	562
	H 96 L 60	GPC90661/2	491	511	526	530	561	611	620
	n° 2 filtri carbone attivo 2 active carbon filters	08750894	+28	+28	+28	+28	+28	+28	+28
	<p>cappa "Mod. F" integrata totale con frontalino vetro estraibile portata 415 m³/h con faretti a led 2 ante</p> <p>N.B. : posizionare la cappa ad una distanza non inferiore ai 55 cm dal piano cottura</p>  <p>"Mod. F" fully integrated hood with glass pull-out front panel air flow rate 415 m³/h with led lights 2 doors</p> <p>Note: position the hood at least 55 cm from the cooker hob</p>	H 60 L 90	GPC90490	532	552	567	563	593	638
H 72 L 90		GPC90590	544	565	583	581	616	671	710
H 96 L 90		GPC90690	578	607	629	631	678	752	788
n° 2 filtri carbone attivo 2 active carbon filters		08750894	+28	+28	+28	+28	+28	+28	+28



CAPPE ASPIRANTI

EXTRACTOR HOODS

P 33,2

N.B.: cerniere ammortizzate di serie

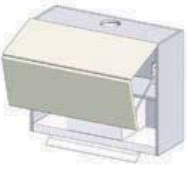
Note: standard blumotion hinges





	COD.	MELA-MINICO	POLIMERICICO		LACCATO			GLAKS	
		KG6	OPACO KG7	LUCIDO KG7	A KG8	B KG8	PELTRO KG8	KG3	
<p>cappa "Mod. F" integrata totale con frontalino vetro estraibile portata 415 m³/h con faretti a led 1 anta apertura a ribalta</p> <p>N.B. : posizionare la cappa ad una distanza non inferiore ai 55 cm dal piano cottura</p> <p>"Mod. F" fully integrated hood with glass pull-out front panel air flow rate 415 m³/h with led lights 1 flap door Note: position the hood at least 55 cm from the cooker hob</p> 	H 36 L 60	GPC80260	439	445	452	449	461	479	497
	H 36 L 90	GPC80290	495	504	513	512	530	557	573
	H 48 L 60	GPC80360	479	488	496	495	511	535	556
	H 48 L 90	GPC80390	525	539	551	553	577	612	631
	n° 2 filtri carbone attivo 2 active carbon filters	08750894	+28	+28	+28	+28	+28	+28	+28
<p>cappa "Mod. F" integrata totale con frontalino vetro estraibile portata 415 m³/h con faretti a led 2 ante apertura a pacchetto</p> <p>N.B. : posizionare la cappa ad una distanza non inferiore ai 55 cm dal piano cottura</p> <p>"Mod. F" fully integrated hood with glass pull-out front panel air flow rate 415 m³/h with led lights 2 lift-up folding doors Note: position the hood at least 55 cm from the cooker hob</p> 	H 72 L 60	GPC83560	632	648	661	656	681	715	752
	H 72 L 90	GPC83590	692	716	733	732	768	821	854
	H 96 L 60	GPC83660	669	695	711	708	740	788	830
	H 96 L 90	GPC83690	737	774	797	801	849	921	958
	n° 2 filtri carbone attivo 2 active carbon filters	08750894	+28	+28	+28	+28	+28	+28	+28
<p>cappa "Mod.F" integrata totale con frontalino estraibile inox portata 450 m³/h 1 anta apertura verticale obliqua</p> <p>N.B. : posizionare la cappa ad una distanza non inferiore ai 55 cm dal piano cottura</p> <p>"Mod. F" fully-integrated hood with glass pull-out front panel flow rate 415 m³/h with led lights 1 door with vertical oblique opening Note: position the hood at least 55 cm from the cooker hob</p> 	H 60 L 60	GPC86460	602	622	624	625	645	674	686
	H 60 L 90	GPC86490	678	711	715	721	752	794	805
	H 72 L 60	GPC86560	633	659	661	662	685	723	733
	H 72 L 90	GPC86590	687	723	730	736	772	827	835
	n° 2 filtri carbone attivo 2 active carbon filters	08750894	+28	+28	+28	+28	+28	+28	+28

BASI

BASE UNITS

H 88 P 61





Le basi non sono comprensive di top - N.B.: cerniere ammortizzate di serie The base units do not include the tops - Note: standard blumotion hinges	COD.	MELAMINICO	POLIMERICO		LACCATO			GLAKS	
		KG6	OPACO KG7	LUCIDO KG7	A KG8	B KG8	PELTRO KG8	KG3	
fascia tamponamento filler panel 	L da 3 a 10 size 3 to 10	G4800000	58	67	73	87	107	114	127
jolly base colore come struttura L da 10 a 30 jolly base unit same colour as carcass size 10 to 30 	in nobilitato melamine coated	G4700000	94	94	94	94	94	94	94
1 anta 1 door 	L 15 L 30 L 40 L 45 L 60 L 65	G4010151/2	109	108	112	112	120	134	152
		G4010301/2	116	122	129	126	138	155	178
		G4010401/2	130	139	147	145	161	185	206
		G4010451/2	138	149	158	157	174	202	221
		G4010601/2	157	173	184	185	209	246	257
		G4010651/2	172	189	201	206	233	269	292
2 ante 2 doors 	L 60 L 80 L 90	G4010600	180	193	205	200	224	259	303
		G4010800	208	226	242	240	271	319	361
		G4010900	222	244	261	259	295	350	389
cestello estraibile chiusura soft pull-out basket drawer soft-closing system 	L 15 L 30 L 45	G4150150	145	144	148	148	156	170	187
		G4150300	186	197	203	200	212	230	248
		G4150450	209	225	234	233	250	278	293

Le basi non sono comprensive di top - N.B.: cassetti e cestoni ad estrazione totale con blumotion The base units do not include the tops - Note: fully extending drawers and deep drawers with blumotion system		COD.	MELAMINICO	POLIMERICO		LACCATO			GLAKS
			KG6	OPACO KG7	LUCIDO KG7	A KG8	B KG8	PELTRO KG8	KG3
 <p>4 cassetti H 16,9 4 drawers H 16,9</p>	L 30	G4100300	297	299	308	323	349	430	432
	L 40	G4100400	323	325	335	342	368	447	466
	L 45	G4100450	335	338	349	353	379	457	486
	L 60	G4100600	377	379	393	391	421	486	538
 <p>2 cassetti H 16,9 1 cestone H 34,2 2 drawers H 16,9 1 deep drawer H 34,2</p>	L 45	G4130450	283	288	299	298	321	370	410
	L 60	G4130600	318	325	338	336	363	410	457
	L 90	G4130900	389	400	420	423	462	493	572
 <p>2 cassetti H 16,9 1 cestone vetro H 34,2 2 drawers H 16,9 1 glass deep drawer H 34,2</p>	telaio polimerico L 45 polymeric frame	G4140450	—	341	352	—	—	—	—
	L 60	G4140600	—	378	392	—	—	—	—
	L 90	G4140900	—	463	483	—	—	—	—
 <p>portaposate in plastica per cassetti plastic cutlery tray for drawers</p>	L 30	08700030X	10	10	10	10	10	10	10
	L 40	08700040X	10	10	10	10	10	10	10
	L 45	08700050X	10	10	10	10	10	10	10
	L 60	08700060X	11	11	11	11	11	11	11
	divisori regolabili L 90 adjustable separators	08700070X	32	32	32	32	32	32	32
 <p>4 cassetti H 16,9 1 cestone H 34,2 4 drawers H 16,9 1 deep drawer H 34,2</p>	L 90	G4300900	494	505	526	530	574	674	721
	telaio polimerico L 90 polymeric frame	G4301900	—	568	589	—	—	—	—





BASI

BASE UNITS

H 88 P 61

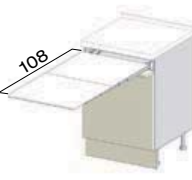
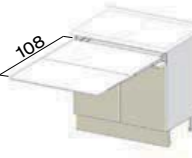
Le basi non sono comprensive di top - N.B.: cassetti e cestoni ad estrazione totale con blumotion The base units do not include the tops - Note: fully extending drawers and deep drawers with blumotion system		COD.	MELA-MINICO	POLIMERICO		LACCATO			GLAKS	
			KG6	OPACO KG7	LUCIDO KG7	A KG8	B KG8	PELTRO KG8	KG3	
 <p>2 cestoni H 34,2 2 deep drawers H 34,2</p>	L 45	G4170450	242	251	260	256	274	295	346	
	L 60	G4170600	272	284	296	294	318	345	389	
	L 90	G4170900	336	355	372	374	410	455	496	
 <p>2 cestoni 1 frontale chiuso H 34,2 1 frontale vetro H 34,2 2 deep drawers 1 full front H 34,2 1 glass front H 34,2</p>										
		telaio polimerico L 45 polymeric frame	G4180450	—	303	313	—	—	—	—
	L 60		G4180600	—	337	349	—	—	—	—
	L 90		G4180900	—	414	432	—	—	—	—
 <p>2 cestoni vetro H 34,2 2 glass deep drawers H 34,2</p>										
		telaio polimerico L 45 polymeric frame	G4190450	—	356	366	—	—	—	—
	L 60		G4190600	—	391	404	—	—	—	—
	L 90		G4190900	—	480	499	—	—	—	—
 <p>1 anta 2 cassetti interni 1 cestone interno posizionare a 5 cm dalla parete laterale 1 door 2 internal drawers 1 internal deep drawer place at 5 cm from the side wall</p>	L 45	G4210461/2	341	351	360	359	377	404	424	
	L 60	G4210611/2	374	391	402	403	426	464	474	
 <p>1 anta 2 cestoni interni posizionare a 5 cm dalla parete laterale 1 door 2 internal deep drawers place at 5 cm from the side wall</p>	L 45	G4210471/2	291	302	311	310	328	355	375	
	L 60	G4210621/2	321	337	348	349	373	410	421	
<p>NELLE INTERRUZIONI DI GOLA, AGGIUNGERE SEMPRE I RELATIVI TERMINALI ADD THE ASSOCIATED CLOSURES TO ANY INTERRUPTIONS IN THE FINGER RAIL</p>										

Le basi non sono comprensive di top
The base units do not include the tops

	COD.	MELAMINICO	POLIMERICO		LACCATO			GLAKS		
		KG6	OPACO KG7	LUCIDO KG7	A KG8	B KG8	PELTRO KG8	KG3		
 <p>base tavolo estraibile LUNCH portata 60 kg 1 anta H 54,5 apertura push-pull 1 frontale H 16,9</p> <p>base unit with pull-out table LUNCH load capacity kg 60 1 door H 54,5 push-pull opening 1 front H 16,9</p>	L 60	G4230601/2	599	610	622	621	647	688	723	
	 <p>base tavolo estraibile LUNCH portata 60 kg 2 ante H 54,5 apertura push-pull 1 frontale H 16,9</p> <p>base unit with pull-out table LUNCH load capacity kg 60 2 doors H 54,5 push-pull opening 1 front H 16,9</p>	L 90	G4230900	654	671	690	689	729	768	851
 <p>terminale aperto dx o sx per gola sottotop tipo "A" da utilizzare a fine composizione</p> <p>type "A" open end LH or RH for under top finger rail, to be used at the end of the composition</p> <p>SX LH DX RH</p>										
		DX	G950041	8	8	8	8	8	8	8
		SX	G950042	8	8	8	8	8	8	8
		DX	G950021	23	23	23	23	23	23	23
 <p>terminale chiuso dx o sx per gola sottotop tipo "A" da utilizzare solo tra basi e colonne</p> <p>type "A" closed end LH or RH for under top finger rail, to be used only between base units and columns</p> <p>SX LH DX RH</p>										
		DX	G950045	8	8	8	8	8	8	8
		SX	G950046	8	8	8	8	8	8	8
		DX	G950031	23	23	23	23	23	23	23
 <p>terminale aperto dx o sx per gola intermedia tipo "B" da utilizzare a fine composizione</p> <p>type "B" open end LH or RH for intermediate finger rail, to be used at the end of the composition</p> <p>SX LH DX RH</p>										
		DX	G950141	8	8	8	8	8	8	8
		SX	G950142	8	8	8	8	8	8	8
		DX	G950121	28	28	28	28	28	28	28
 <p>terminale chiuso dx o sx per gola intermedia tipo "B" da utilizzare solo tra cassettiere e lavastoviglie/colonne</p> <p>type "B" closed end LH or RH for intermediate finger rail, to be used only between drawer base units or dishwasher base units and columns</p> <p>SX LH DX RH</p>										
		DX	G950145	8	8	8	8	8	8	8
		SX	G950146	8	8	8	8	8	8	8
		DX	G950131	28	28	28	28	28	28	28

BASI ANGOLO

CORNER BASE UNITS

H 88 P 65

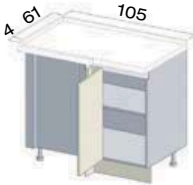
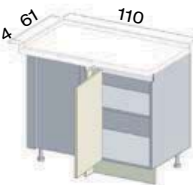
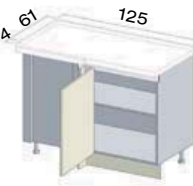
Le basi non sono comprensive di top - N.B.: cerniere ammortizzate di serie The base units do not include the tops - Note: standard blumotion hinges		COD.	MELA-MINICO	POLIMERICO		LACCATO			GLAKS
			KG6	OPACO KG7	LUCIDO KG7	A KG8	B KG8	PELTRO KG8	KG3
 <p>angolo L 95 1 ripiano 1 anta L 30 (cerniere a pilastro) cassone 90 corner unit W 95 1 shelf 1 door W 30 (pillar hinges) structure 90</p> <p>verso dx RH version</p>	95x65	G4400951/2	303	325	334	320	353	380	398
 <p>angolo L 105 1 ripiano 1 anta L 40 (cerniere a pilastro) cassone 90 corner unit W 105 1 shelf 1 door W 40 (pillar hinges) structure 90</p> <p>verso dx RH version</p>	105x65	G4401041/2	312	337	348	335	372	406	422
 <p>angolo L 110 1 ripiano 1 anta L 45 (cerniere a pilastro) cassone 105 corner unit W 110 1 shelf 1 door W 45 (pillar hinges) structure 105</p> <p>verso dx RH version</p>	110x65	G4401091/2	331	357	370	357	395	433	449
 <p>angolo L 125 1 ripiano 1 anta L 60 (cerniere a pilastro) cassone 120 corner unit W 125 1 shelf 1 door W 60 (pillar hinges) structure 120</p> <p>verso dx RH version</p>	125x65	G4401241/2	348	380	394	383	428	475	482
<p>NELLE INTERRUZIONI DI GOLA, AGGIUNGERE SEMPRE I RELATIVI TERMINALI ADD THE ASSOCIATED CLOSURES TO ANY INTERRUPTIONS IN THE FINGER RAIL</p>									

BASI ANGOLO

CORNER BASE UNITS

H 88 P 65



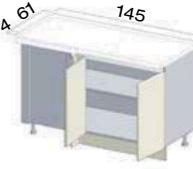
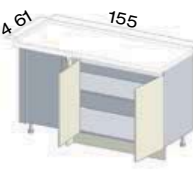
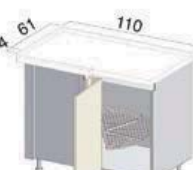
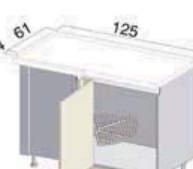

Le basi non sono comprensive di top - N.B.: cerniere ammortizzate di serie
 The base units do not include the tops - Note: standard blumotion hinges

	COD.	MELA-MINICO	POLIMERICO		LACCATO			GLAKS	
		KG6	OPACO KG7	LUCIDO KG7	A KG8	B KG8	PELTRO KG8	KG3	
 <p>angolo L 145 1 ripiano 2 ante L 40 (cerniere a pilastro) cassone 140 corner unit W 145 1 shelf 2 doors W 40 (pillar hinges) structure 140</p> <p>verso dx RH version</p>	145x65	G4401451/2	397	430	450	435	487	545	583
 <p>angolo L 155 1 ripiano 2 ante L 45 (cerniere a pilastro) cassone 150 corner unit W 155 1 shelf 2 doors W 45 (pillar hinges) structure 150</p> <p>verso dx RH version</p>	155X65	G4401551/2	406	443	464	450	507	572	607
 <p>angolo L 110 cestello mezzaluna 1 anta L 45 (cerniere a pilastro) cassone 105 corner unit W 110 crescent-shaped wire basket drawer 1 door W 45 (pillar hinges) structure 105</p> <p>verso dx RH version</p>	1 cestello 110x65 1 basket drawer	G4401101/2	331	357	370	357	395	433	449
	2 cestelli 110x65 2 basket drawers	G4401111/2	358	384	396	383	422	460	475
 <p>angolo L 125 cestello mezzaluna 1 anta L 60 (cerniere a pilastro) cassone 120 corner unit W 125 crescent-shaped wire basket drawer 1 door W 60 (pillar hinges) structure 120</p> <p>verso dx RH version</p>	1 cestello 125x65 1 basket drawer	G4401251/2	348	380	394	383	428	475	482
	2 cestelli 125x65 2 basket drawers	G4401261/2	374	406	421	410	454	502	508
<p>NELLE INTERRUZIONI DI GOLA, AGGIUNGERE SEMPRE I RELATIVI TERMINALI ADD.THE ASSOCIATED CLOSURES TO ANY INTERRUPTIONS IN THE FINGER RAIL</p>									

BASI ANGOLO

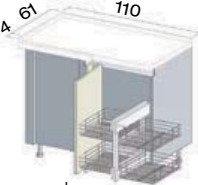
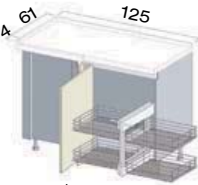
CORNER BASE UNITS

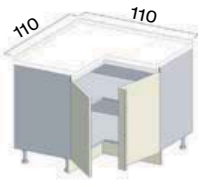
H 88 P 65





Le basi non sono comprensive di top - N.B.: cerniere ammortizzate di serie The base units do not include the tops - Note: standard blumotion hinges		COD.	MELAMINICO	POLIMERICO		LACCATO			GLAKS
			KG6	OPACO KG7	LUCIDO KG7	A KG8	B KG8	PELTRO KG8	KG3
 <p>angolo L 110 4 cestelli estraibili indipendenti dall'anta 1 anta L 45 (cerniere a pilastro) cassone 105 corner unit W 110 4 pull-out basket drawers opening independently from door 1 door W 45 (pillar hinges) structure 105</p> <p>verso dx RH version</p>	110x65	G4451101/2	841	894	906	893	932	970	959
 <p>angolo L 125 4 cestelli estraibili indipendenti dall'anta 1 anta L 60 (cerniere a pilastro) cassone 120 corner unit W 125 4 pull-out basket drawers opening independently from door 1 door W 60 (pillar hinges) structure 120</p> <p>verso dx RH version</p>	125x65	G4451251/2	908	966	981	970	1.014	1.035	1.042
 <p>angolo 95x95 1 ripiano 2 ante L 30 (cerniere 180°) angolare unito all'anta dx corner unit 95x95 1 shelf 2 doors W 30 (180° hinges) angular filler attached to the RH door</p>	95x95	G4480950	452	483	501	472	522	572	637
 <p>angolo 110x110 1 ripiano 2 ante L 45 (cerniere 180°) angolare unito all'anta dx corner unit 110x110 1 shelf 2 doors W 45 (180° hinges) angular filler attached to the RH door</p>	110x110	G4481100	512	553	576	551	614	686	745
 <p>terminale aperto dx o sx per gola sottotop tipo "A" da utilizzare a fine composizione type "A" open end LH or RH for under top finger rail, to be used at the end of the composition</p> <p>SX LH DX RH</p>	<p>in plastica colore alluminio plastic aluminium colour</p> <p>DX</p> <p>SX</p> <p>in alluminio colore bianco, brown, beige aluminium white, brown, beige colours</p> <p>DX</p> <p>SX</p>	G950041	8	8	8	8	8	8	8
		G950042	8	8	8	8	8	8	8
		G950021	23	23	23	23	23	23	23
		G950022	23	23	23	23	23	23	23
 <p>terminale chiuso dx o sx per gola sottotop tipo "A" da utilizzare solo tra basi e colonne type "A" closed end LH or RH for under top finger rail, to be used only between base units and columns</p> <p>SX LH DX RH</p>	<p>in plastica colore alluminio plastic aluminium colour</p> <p>DX</p> <p>SX</p> <p>in alluminio colore bianco, brown, beige aluminium white, brown, beige colours</p> <p>DX</p> <p>SX</p>	G950045	8	8	8	8	8	8	8
		G950046	8	8	8	8	8	8	8
		G950031	23	23	23	23	23	23	23
		G950032	23	23	23	23	23	23	23

BASI PER FORNI

H 88 P 61

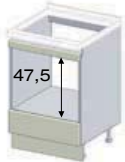
OVEN BASE UNITS



Le basi non sono comprensive di top - N.B.: cassetti ad estrazione totale con blumotion
 The base units do not include the tops - Note: fully extending drawers with blumotion system

	COD.	MELAMINICO	POLIMERICO		LACCATO			GLAKS		
		KG6	OPACO KG7	LUCIDO KG7	A KG8	B KG8	PELTRO KG8	KG3		
 <p>base per forno elettrico e gas H 60 fascia superiore e inferiore H 5,7 electric and gas oven base unit H 60 upper and lower panel H 5,7</p>	L 60	G5510600	164	152	157	167	182	216	215	
	 <p>base per forno elettrico H 48 cassetto H 16,9 inferiore electric oven base unit H 48 lower drawer H 16,9</p>	L 60	G5530600	212	207	213	217	232	266	280
 <p>base per maxiforno H 60 fascia superiore e inferiore H 5,7 maxi-oven base unit H 60 upper and lower panel H 5,7</p>		L 90	G5510900	203	186	192	198	215	244	250
	 <p>base per maxiforno H 48 cassetto H 16,9 inferiore maxi-oven base unit H 48 lower drawer H 16,9</p>	L 90	G5530900	275	264	273	281	300	319	353
 <p>terminale aperto dx o sx per gola sottotop tipo "A" da utilizzare a fine composizione type "A" open end LH or RH for under top finger rail, to be used at the end of the composition</p> <p>SX LH DX RH</p>										
		DX	G950041	8	8	8	8	8	8	8
		SX	G950042	8	8	8	8	8	8	8
		DX	G950021	23	23	23	23	23	23	23
	SX	G950022	23	23	23	23	23	23	23	
 <p>terminale chiuso dx o sx per gola sottotop tipo "A" da utilizzare solo tra basi e colonne type "A" closed end LH or RH for under top finger rail, to be used only between base units and columns</p> <p>SX LH DX RH</p>										
		DX	G950045	8	8	8	8	8	8	8
		SX	G950046	8	8	8	8	8	8	8
		DX	G950031	23	23	23	23	23	23	23
	SX	G950032	23	23	23	23	23	23	23	

BASI PER FORNI

H 88 P 61





OVEN BASE UNITS

Le basi non sono comprensive di top The base units do not include the tops	COD.	MELA-MINICO	POLIMERICO		LACCATO			GLAKS	
		KG6	OPACO KG7	LUCIDO KG7	A KG8	B KG8	PELTRO KG8	KG3	
 <p>kit raccordo base angolo junction kit for corner base unit</p>									
	110x110	G5471100	220	185	190	207	222	252	256
 <p>kit raccordo base angolo per inserimento lavastoviglie a destra o sinistra junction kit for corner base unit for dishwasher placed on the right or the left side</p>									
	<p>verso dx RH version</p>	110x110	G5471151/2	255	220	225	242	258	287

BASI PER PIANI COTTURA

H 88 P 61

COOKER HOB BASE UNITS



Le basi non sono comprensive di top The base units do not include the tops	COD.	MELA- MINICO	POLIMERICO		LACCATO			GLAKS	
		KG6	OPACO KG7	LUCIDO KG7	A KG8	B KG8	PELTRO KG8	KG3	
 <p>base predisposta piano cottura 1 anta base unit configured for cooker hob 1 door</p>	L 60	G5500601/2	164	180	192	192	216	254	264
	L 90	G5500900	229	251	268	266	302	357	396
 <p>base predisposta piano cottura 2 ante base unit configured for cooker hob 2 doors</p>	110x110	G5471100	220	185	190	207	222	252	256
	110x110	G5471151/2	255	220	225	242	258	287	292
 <p>kit raccordo base angolo junction kit for corner base unit</p>									
 <p>kit raccordo base angolo per inserimento lavastoviglie a destra o sinistra junction kit for corner base unit for dishwasher placed on the right or the left side</p> <p>verso dx RH version</p>									

SOTTOLAVELLI

SINK BASE UNITS

H 88 P 61

Le basi non sono comprensive di top - N.B.: cerniere ammortizzate di serie
 The base units do not include the tops - **Note:** standard blumotion hinges

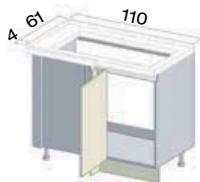
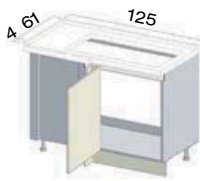
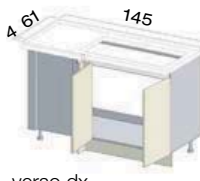

	COD.	MELA-MINICO	POLIMERICO		LACCATO			GLAKS	
		KG6	OPACO KG7	LUCIDO KG7	A KG8	B KG8	PELTRO KG8	KG3	
 <p>sottolavello 1 anta sink base unit 1 door</p>	L 45	G5010451/2	140	150	159	156	176	201	223
	L 60	G5010601/2	156	173	184	185	206	246	256
 <p>sottolavello 2 ante sink base unit 2 doors</p>	L 60	G5010600	177	190	203	195	219	256	300
	L 80	G5010800	209	227	243	238	270	318	362
	L 90	G5010900	218	240	257	256	291	344	385
	L 120	G5011200	256	289	311	311	358	436	456
 <p>sottolavello 2 cestoni H 34,2 cestone superiore sagomato con vaschette sink base unit 2 deep drawers H 34,2 contoured upper deep drawer with trays</p>	L 60	G5200600	301	314	326	324	348	377	419
	L 90	G5200900	362	380	397	397	435	481	521
 <p>sottolavello angolo L 110 1 anta L 45 (cerniere pilastro) cassone 105 corner sink base unit W 110 1 door W 45 (pillar hinges) structure 105</p> <p>verso dx RH version</p>	110x65	G4421101/2	300	327	339	326	365	402	418
 <p>sottolavello angolo L 125 1 anta L 60 (cerniere pilastro) cassone 120 corner sink base unit W 125 1 door W 60 (pillar hinges) structure 120</p> <p>verso dx RH version</p>	125x65	G4421251/2	320	352	366	355	400	447	454
 <p>sottolavello angolo L 145 2 ante L 40 (cerniere pilastro) cassone 140 corner sink base unit W 145 2 doors W 40 (pillar hinges) structure 140</p> <p>verso dx RH version</p>	145x65	G4421451/2	363	396	416	401	454	511	549

SOTTOLAVELLI

H 88 P 61

SINK BASE UNITS

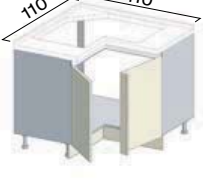

Le basi non sono comprensive di top - N.B.: cerniere ammortizzate di serie
 The base units do not include the tops - Note: standard blumotion hinges

	COD.	MELA-MINICO	POLIMERICO		LACCATO			GLAKS	
		KG6	OPACO KG7	LUCIDO KG7	A KG8	B KG8	PELTRO KG8	KG3	
 <p>sottolavello angolo L 155 2 ante L 45 (cerniere pilastro) cassone 150 corner sink base unit W 155 2 doors W 45 (pillar hinges) structure 150</p> <p>verso dx RH version</p>	155x65	G4421551/2	376	413	434	420	477	542	577
	 <p>sottolavello angolo 95x95 2 ante L 30 (cerniere 180°) angolare unito all'anta dx corner sink base unit 95x95 2 doors W 30 (180° hinges) angular filler attached to the RH door</p>	95x95	G5020950	378	405	422	399	444	489
 <p>sottolavello angolo 110x110 2 ante L 45 (cerniere 180°) angolare unito all'anta dx corner sink base unit 110x110 2 doors W 45 (180° hinges) angular filler attached to the RH door</p>		110x110	G5021100	435	472	493	474	530	595
	<p>NELLE INTERRUZIONI DI GOLA, AGGIUNGERE SEMPRE I RELATIVI TERMINALI ADD.THE ASSOCIATED CLOSURES TO ANY INTERRUPTIONS IN THE FINGER RAIL</p>								

BASI PER ELETTRODOMESTICI SOTTOTOP

H 88 P 61

BASE UNITS FOR UNDER-TOP APPLIANCES

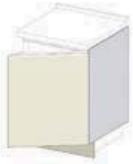
Le basi non sono comprensive di top The base units do not include the tops		COD.	MELA-MINICO	POLIMERICO		LACCATO			GLAKS
			KG6	OPACO KG7	LUCIDO KG7	A KG8	B KG8	PELTRO KG8	KG3
 <p>anta per lavastoviglie scomparsa totale door for fully integrated dishwasher</p>	L 45	G4490080	89	101	110	109	128	158	179
	L 60	G4490090	102	120	132	133	158	199	210
	L 60	G4490300	157	171	177	181	207	249	284
 <p>anta per lavastoviglie a scomparsa totale estetica 2 cestoni door for aesthetic fully integrated dishwasher 2 deep drawers</p>	coppia couple	08630090	16	16	16	16	16	16	16
		08630090	16	16	16	16	16	16	16
 <p>anta per lavabiancheria scomparsa totale door for fully integrated washing machine</p>	L 60	G4490011/2	102	120	132	133	158	199	210
	L 60	G4490151/2	127	145	157	158	180	224	235
 <p>anta con fianco per frigo e congelatore sottotop door with side panel for under-top fridge and freezer</p>	L 60	G4490181/2	102	120	132	133	158	199	210
	L 60	G4490181/2	102	120	132	133	158	199	210

BASI PER ELETTRODOMESTICI SOTTOTOP

H 88 P 61

BASE UNITS FOR UNDER-TOP APPLIANCES

Le basi non sono comprensive di top
The base units do not include the tops

**fianco per elettrodomestici a fine
composizione**

side panel for appliances placed at the end of the
composition









COD.	MELAMINICO	POLIMERICICO		LACCATO			GLAKS
	KG6	OPACO KG7	LUCIDO KG7	A KG8	B KG8	PELTRO KG8	KG3
in nobilitato melamine coated							
H 88x60x2 zoccolo H 13 plinth	G94612	29	29	29	29	29	29
H 90x60x2 zoccolo H 15 plinth	G94615	29	29	29	29	29	29
come anta liscio as smooth door							
H 88x59,6x2 zoccolo H 13 plinth	G94702	54	75	88	92	123	171
H 90x59,6x2 zoccolo H 15 plinth	G94705	54	75	88	92	123	171

BASI H 76 PER TOP H 12

H 76 P 61

LOWERED BASE UNITS H 76 FOR TOP H 12

Le basi non sono comprensive di top - N.B.: cerniere ammortizzate di serie
 The base units do not include the tops - Note: standard blumotion hinges





	COD.	MELAMINICO	POLIMERICICO		LACCATO			GLAKS	
		KG6	OPACO KG7	LUCIDO KG7	A KG8	B KG8	PELTRO KG8	KG3	
 <p>base H 76 1 anta base unit H 76 1 door</p>	L 45	G4030451/2	142	152	159	157	173	196	216
	L 60	G4030601/2	165	177	187	188	209	238	251
 <p>base H 76 2 ante base unit H 76 2 doors</p>	L 90	G4030900	225	244	260	256	286	332	373
	L 120	G4031200	266	290	310	312	353	412	438
 <p>base H 76 2 cassetti H 16,9 1 cassetto H 22,2 base unit H 76 2 drawers H 16,9 1 drawer H 22,2</p>	L 45	G4255450	277	280	289	292	313	366	387
	L 60	G4255600	312	314	326	327	352	391	432
	L 90	G4255900	352	354	365	367	389	397	450
 <p>base H 76 1 cassetto H 22,2 1 cassetto H 34,2 base unit H 76 1 drawer H 22,2 1 deep drawer H 34,2</p>	L 45	G4260450	237	243	251	250	267	292	324
	L 60	G4260600	267	275	285	286	308	330	366
	L 90	G4260900	301	310	318	319	337	360	378
 <p>base H 76 predisposta per forno H 48 fascia inferiore e superiore H 5,5 base unit H 76 configured for oven H 48 upper and lower filler H 5,5</p>	L 60	G5540600	164	152	157	167	182	216	215
 <p>base H 76 predisposta per lavastoviglie REX TCC 800 1 cassetto H 10,3 base unit H 76 configured for Rex TCC 800 dishwasher 1 drawer H 10,3</p>	L 60	G4580600	303	268	280	285	311	353	375

SOTTOLAVELLI H 76 PER TOP H 12

H 76 P 61

SINK BASE UNITS H 76 FOR TOP H 12

Le basi non sono comprensive di top - N.B.: cerniere ammortizzate di serie
The base units do not include the tops - Note: standard blumotion hinges

COD.	MELAMINICO	POLIMERICO		LACCATO			GLAKS		
	KG6	OPACO KG7	LUCIDO KG7	A KG8	B KG8	PELTRO KG8	KG3		
 <p>sottolavello H 76 1 ante sink base unit H 76 1 door</p>									
	L 45	G5060451/2	146	156	163	162	176	199	219
	L 60	G5060601/2	165	177	186	187	207	236	249
 <p>sottolavello H 76 2 ante sink base unit H 76 2 doors</p>									
	L 90	G5060900	220	239	254	251	280	326	365
	L 120	G5061200	260	284	303	305	345	403	429
 <p>terminale aperto dx o sx per gola sottotop tipo "A" da utilizzare a fine composizione type "A" open end LH or RH for under top finger rail, to be used at the end of the composition</p>									
		in plastica colore alluminio plastic aluminium colour							
	DX	G950041	8	8	8	8	8	8	
	SX	G950042	8	8	8	8	8	8	
		in alluminio colore bianco, brown, beige aluminium white, brown, beige colours							
	DX	G950021	23	23	23	23	23	23	
SX	G950022	23	23	23	23	23	23		
 <p>terminale chiuso dx o sx per gola sottotop tipo "A" da utilizzare solo tra basi e colonne type "A" closed end LH or RH for under top finger rail, to be used only between base units and columns</p>									
		in plastica colore alluminio plastic aluminium colour							
	DX	G950045	8	8	8	8	8	8	
	SX	G950046	8	8	8	8	8	8	
		in alluminio colore bianco, brown, beige aluminium white, brown, beige colours							
	DX	G950031	23	23	23	23	23	23	
SX	G950032	23	23	23	23	23	23		
<p>NELLE INTERRUZIONI DI GOLA, AGGIUNGERE SEMPRE I RELATIVI TERMINALI ADD THE ASSOCIATED CLOSURES TO ANY INTERRUPTIONS IN THE FINGER RAIL</p>									

BASI SOSPESSE con Attaccaglie e Barre Fissaggio a parete

H 37,5 - 51 - 63 P 61

HANGING BASE UNITS with Hangers and Rods for wall mounting







Le basi non sono comprensive di top - N.B.: cerniere ammortizzate di serie The base units do not include the tops - Note: standard blumotion hinges		COD.	MELAMINICO	POLIMERICICO		LACCATO			GLAKS
			KG6	OPACO KG7	LUCIDO KG7	A KG8	B KG8	PELTRO KG8	KG3
 <p>base H 37,5 1 anta H 34,2 base unit H 37,5 1 door H 34,2</p>	L 45	G4321451/2	134	139	144	141	150	161	187
	L 60	G4321601/2	148	154	161	159	172	186	207
 <p>base H 51 1 anta H 47,7 base unit H 51 1 door H 47,7</p>	L 45	G4320451/2	149	155	161	158	170	188	214
	L 60	G4320601/2	166	175	183	181	197	221	242
 <p>base H 63 1 anta H 59,7 base unit H 63 1 door H 59,7</p>	L 45	G4322451/2	151	161	168	166	181	204	224
	L 60	G4322601/2	171	183	192	193	214	243	255
 <p>base H 37,5 2 ante H 34,2 base unit H 37,5 2 doors H 34,2</p>	L 90	G4321900	190	199	209	204	223	244	295
	L 120	G4322200	217	229	241	239	263	292	334
 <p>base H 51 2 ante H 47,7 base unit H 51 2 doors H 47,7</p>	L 90	G4320900	218	229	241	236	260	295	348
	L 120	G4321200	250	268	284	281	312	361	402
 <p>base H 63 2 ante H 59,7 base unit H 63 2 doors H 59,7</p>	L 90	G4322900	223	243	257	254	284	329	368

BASI SOSPESE con Attaccaglie e Barre Fissaggio a parete

H 37,5 - 51 P 61

HANGING BASE UNITS with Hangers and Rods for wall mounting

Le basi non sono comprensive di top - N.B.: cassetti e cestoni ad estrazione totale con blumotion
The base units do not include the tops - Note: fully extending drawers and deep drawers with blumotion system

	COD.	MELAMINICO	POLIMERICO		LACCATO			GLAKS	
		KG6	OPACO KG7	LUCIDO KG7	A KG8	B KG8	PELTRO KG8	KG3	
 <p>base H 37,5 1 cestone H 34,2 base H 37,5 1 deep drawer H 34,2</p>	L 45	G4311450	181	185	190	188	197	207	334
	L 60	G4311600	199	205	211	210	223	237	258
	L 90	G4311900	236	245	254	255	273	296	315
 <p>base H 51 1 cestone H 47,7 base unit H 51 1 deep drawer H 47,7</p>	L 45	G4310450	187	192	198	196	208	225	250
	L 60	G4310600	205	214	222	221	237	261	280
	L 90	G4310900	243	258	269	271	295	331	345
 <p>sottolavello H 51 1 cestone sagomato H 47,7 scarico salvaspazio sink base unit H 51 1 contoured deep drawer H 47,7 space-saver drain piping</p>	L 90	G5240900	263	278	289	290	315	351	370
 <p>base H 63 1 cestone H 59,7 base unit H 63 1 deep drawer H 59,7</p>	L 45	G4312450	272	279	286	288	303	325	343
	L 60	G4312600	300	309	319	323	343	372	385
	L 90	G4312900	353	373	386	396	427	470	477
 <p>sottolavello H 63 1 cestone H 59,7 scarico salvaspazio sink base unit H 63 1 deep drawer H 59,7 with space-saver drain piping</p>	L 60	G5250600	240	251	262	263	283	312	325
	L 90	G5250900	275	298	312	318	349	391	402
 <p>sottolavello H 63 1 cestone H 59,7 con pattumiera integrata scarico salvaspazio skin base unit H 63 1 deep drawer H 59,7 with incorporated waste bins space-saver drain piping</p>	L 60	G525060P	324	336	346	347	367	396	409
	L 90	G525090P	346	370	383	389	463	420	474

COMPOSIZIONE CON ELEMENTI INCLINATI

COMPOSITION WITH INCLINED ELEMENTS

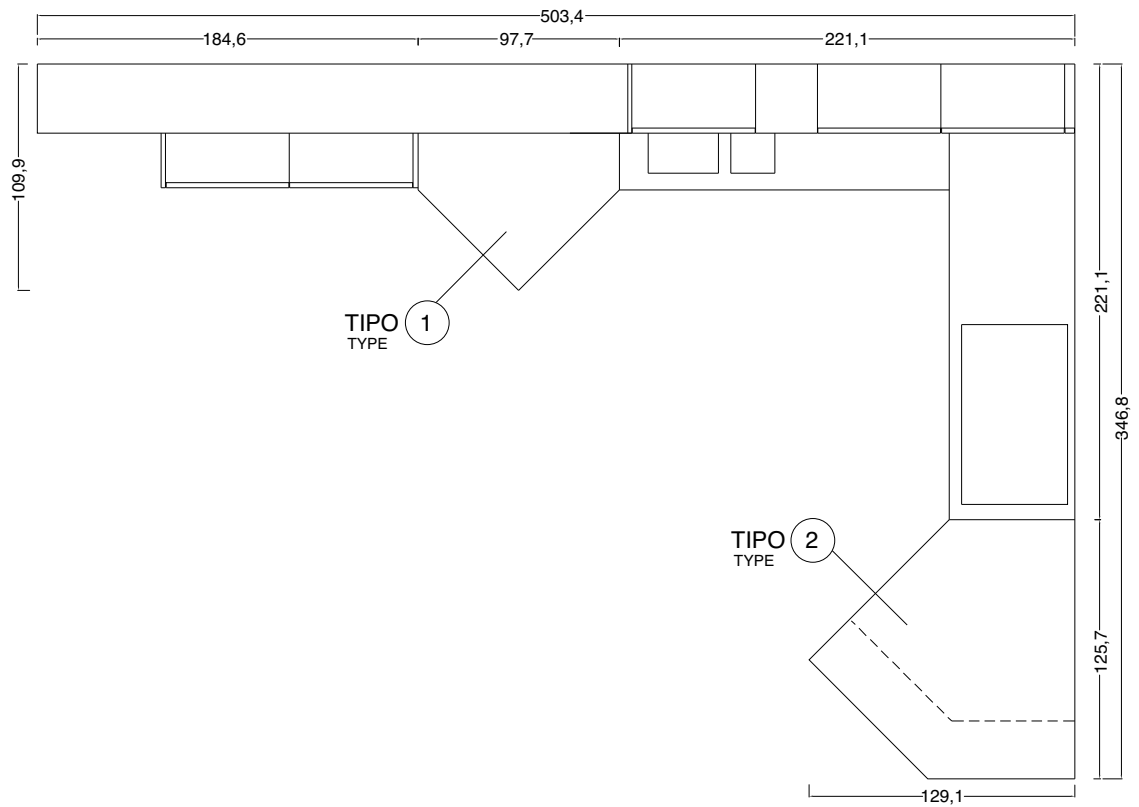
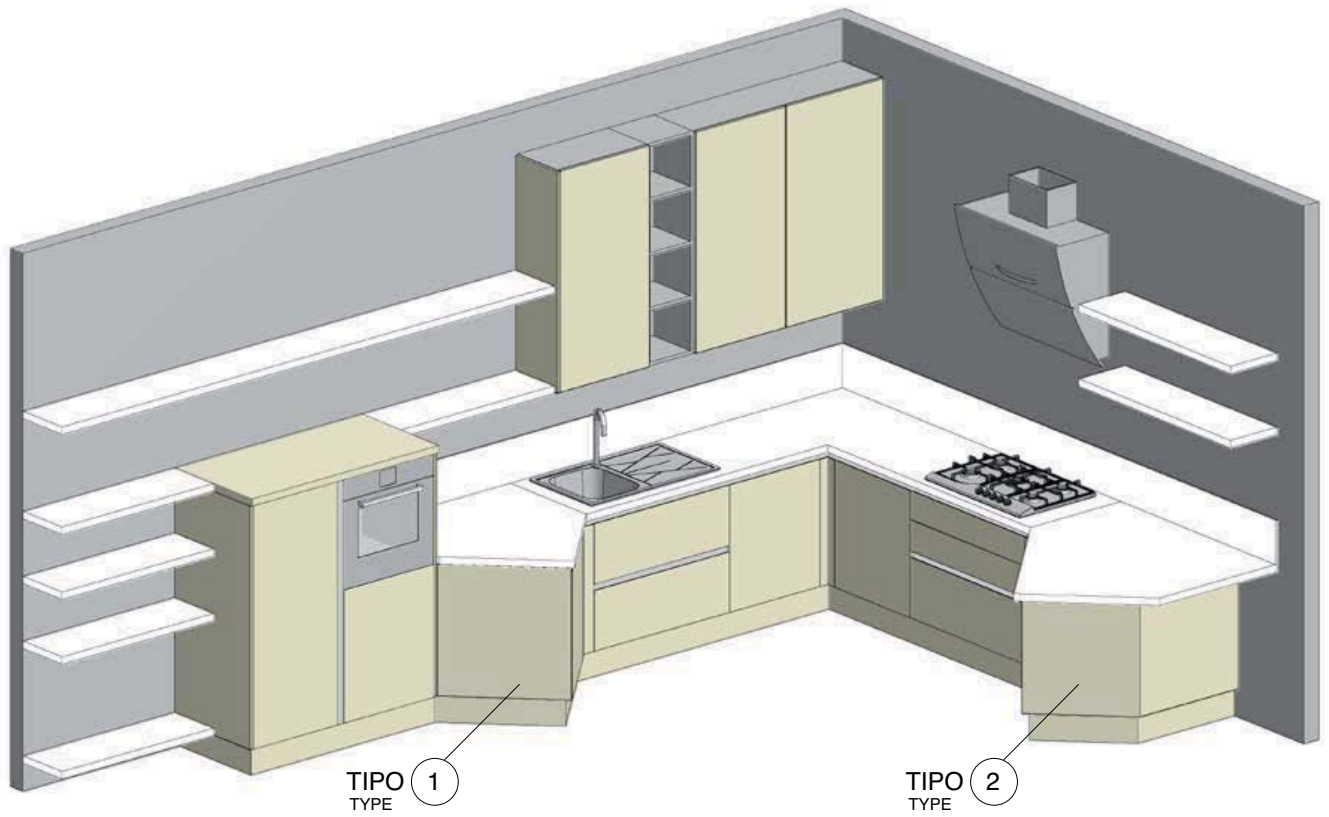

BASE INCLINATA "TIPO 1"

INCLINED BASE UNIT "TYPE 1"

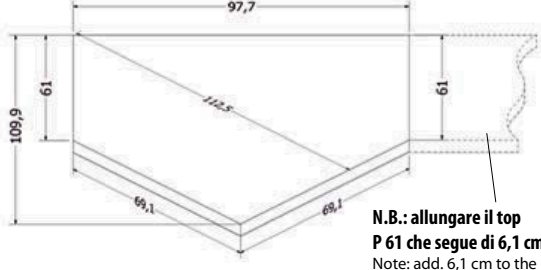
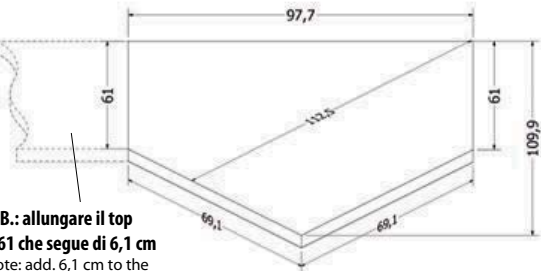
LE BASI NON SONO COMPRENSIVE DI TOP THE BASE UNITS DO NOT INCLUDE THE TOPS	COD.	MELAMINICO	POLIMERICO		LACCATO			GLAKS
		KG6	OPACO KG7	LUCIDO KG7	A KG8	B KG8	PELTRO KG8	KG3
kit base inclinata "tipo 1" per vano L 60 inclined base unit "type 1" kit W 60								
								
top per base inclinata "tipo 1" worktop for inclined base unit "type 1"								
								
N.B.: allungare il top P 61 che segue di 6,1 cm Note: add. 6,1 cm to the worktop next to the inclined base unit								
verso sx LH version								
								
N.B.: allungare il top P 61 che segue di 6,1 cm Note: add. 6,1 cm to the worktop next to the inclined base unit								
verso dx RH version								
97,7x109,9 lamin.bordo ABS1								
H 4 T9062621/2	201	240	260	259	318	382	376	
97,7x109,9 laminato Fenix NTM								
H 2 TFEN2681/2								
H 4 TFEN4681/2								
97,7x109,9 quarzo pasta piena profilo P								
H 2 TQRP2681/2								
fascia "A"	840	840	840	840	840	840	840	
fascia "B"	896	896	896	896	896	896	896	
fascia "C"	968	968	968	968	968	968	968	
H 3 TQRP3681/2								
fascia "A"	859	859	859	859	859	859	859	
fascia "B"	952	952	952	952	952	952	952	
fascia "C"	1.024	1.024	1.024	1.024	1.024	1.024	1.024	
97,7x109,9 quarzo bordo quarzo profilo P								
H 4 TQRP4681/2								
fascia "A"	1.002	1.002	1.002	1.002	1.002	1.002	1.002	
fascia "B"	1.096	1.096	1.096	1.096	1.096	1.096	1.096	
fascia "C"	1.168	1.168	1.168	1.168	1.168	1.168	1.168	

BASE INCLINATA SNACK "TIPO 2"

INCLINED SNACK BASE UNIT "TYPE 2"

LE BASI NON SONO COMPRENSIVE DI TOP
THE BASE UNITS DO NOT INCLUDE THE TOPS

kit base snack "tipo 2" per vano L 60
inclined snack base unit "type 2" kit W 60

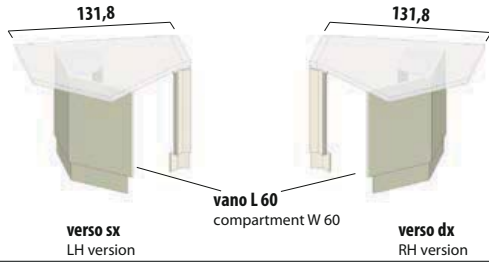

top per base snack "tipo 2"
worktop for inclined snack base unit "type 2"

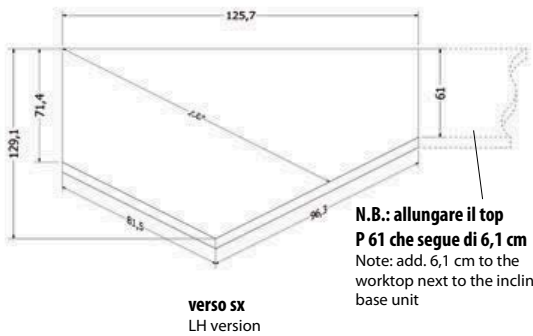

verso sx
LH version

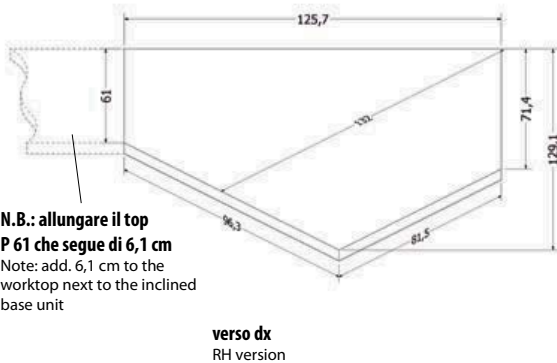

verso dx
RH version





COD.	MELAMINICO	POLIMERICO		LACCATO			GLAKS
	KG6	OPACO KG7	LUCIDO KG7	A KG8	B KG8	PELTRO KG8	KG3
G4910071/2	287	344	375	377	462	563	576
125,7x129,1 lamin.bordo ABS1							
H 4 T9062631/2	429	429	429	429	429	429	429
125,7x129,1 laminato Fenix NTM							
H 2 TFEN2691/2	519	519	519	519	519	519	519
H 4 TFEN4691/2	519	519	519	519	519	519	519
125,7x129,1 quarzo pasta piena profilo P							
H 2 TQRP2691/2							
fascia "A"	865	865	865	865	865	865	865
fascia "B"	959	959	959	959	959	959	959
fascia "C"	1.030	1.030	1.030	1.030	1.030	1.030	1.030
H 3 TQRP3691/2							
fascia "A"	885	885	885	885	885	885	885
fascia "B"	975	975	975	975	975	975	975
fascia "C"	1.044	1.044	1.044	1.044	1.044	1.044	1.044
Foro rettangolare T9FRE	85	85	85	85	85	85	85
125,7x129,1 quarzo bordo quarzo profilo P							
H 4 TQRP4691/2							
fascia "A"	1.065	1.065	1.065	1.065	1.065	1.065	1.065
fascia "B"	1.158	1.158	1.158	1.158	1.158	1.158	1.158
fascia "C"	1.230	1.230	1.230	1.230	1.230	1.230	1.230
Foro rettangolare T9FRE	85	85	85	85	85	85	85

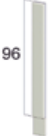

COLONNE H 109

COLUMNS H 109





P 59,7

Le colonne non sono comprensive di top - N.B.: cerniere ammortizzate di serie The columns do not include the tops - <i>Note: standard blumotion hinges</i>	COD.	MELAMINICO	POLIMERICO		LACCATO			GLAKS	
		KG6	OPACO KG7	LUCIDO KG7	A KG8	B KG8	PELTRO KG8	KG3	
fascia tamponamento da 5 a 10 filler panel size 5 to 10 									
	in nobilitato melamine coated	G6000010	40	30	30	30	30	30	30
	come anta con supporto same as door with support	G6000140	80	97	104	132	157	161	158
1 anta 1 door 									
	L 30	G6040301/2	177	186	195	193	210	235	253
	L 40	G6040401/2	188	202	213	214	237	270	290
	L 45	G6040451/2	193	209	221	222	247	287	306
1 anta vetro 1 glass door 									
	telaio petro-polimerico L 45 pewter-polymeric frame	G6046451/2	366	278	285	366	366	366	—
	telaio alluminio 419S L 45 aluminium frame	G6047451/2	296	296	296	296	296	296	—
*1 anta (cerniere 180°) 2 cassetti interni 1 cestone interno *1 door (180° hinges) 2 internal drawers 1 internal deep drawer 									
	L 45	G6041461/2	373	389	401	402	427	467	486
	L 60	G6041611/2	413	437	452	457	490	543	553
NELLE COLONNE PER L'APERTURA DELLE ANTE E' OBBLIGATORIO L'INSERIMENTO DELLE GOLE VERTICALI VERTICAL FINGER RAILS MUST BE FITTED TO COLUMNS WITH OPENING DOORS									
*LE COLONNE CON CASSETTI E CESTONI INTERNI VANNO SEMPRE POSIZIONATE A 5 CM DALLA PARETE LATERALE *COLUMNS WITH INTERNAL DRAWERS AND DEEP DRAWERS SHOULD ALWAYS BE PLACED 5 CM FROM THE SIDE WALL									

COLONNE H 109

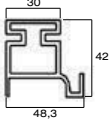
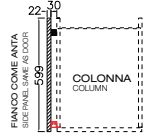
COLUMNS H 109

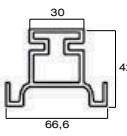

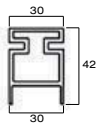
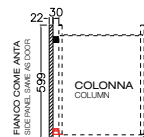

P 59,7

	COD.	MELAMINICO	POLIMERICO		LACCATO			GLAKS
		KG6	OPACO KG7	LUCIDO KG7	A KG8	B KG8	PELTRO KG8	KG3
mezza gola verticale tipo "C" H 96 finger rail type "C" H 96    <p>Sezione gola tipo "C" Type "C" finger rail section</p>	gola finger rail	G950310	56	56	56	56	56	56
	gola con fianco come anta montato finger rail mounted on side panel same as door	G950319	114	166	195	154	186	236
gola verticale intermedia tipo "D" H 96 vertical intermediate finger rail type "D" H 96   <p>Sezione gola tipo "D" Type "D" finger rail section</p>	gola finger rail	G950410	56	56	56	56	56	56
	gola verticale laterale tipo "E" H 96 vertical lateral finger rail type "E" H 96    <p>Sezione gola tipo "E" Type "E" finger rail section</p>	gola finger rail	G950510	56	56	56	56	56
gola con fianco come anta montato finger rail mounted on side panel same as door		G950519	114	166	195	154	186	236

COLONNE H 145

COLUMNS H 145

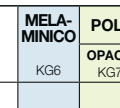
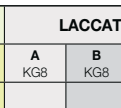

P 59,7

Le colonne non sono comprensive di top - N.B.: cerniere ammortizzate di serie The columns do not include the tops - Note: standard blumotion hinges		COD.	MELAMINICO	POLIMERICO		LACCATO			GLAKS
			KG6	OPACO KG7	LUCIDO KG7	A KG8	B KG8	PELTRO KG8	KG3
 <p>fascia tamponamento da 5 a 10 filler panel size 5 to 10</p> <p>132</p>	<p>in nobilitato melamine coated</p>	G6000020	40	32	32	32	32	32	32
	<p>come anta con supporto same as door with support</p>	G6000150	90	107	117	132	156	160	158
 <p>1 anta 1 door</p>	L 30	G6050301/2	205	219	230	233	257	289	322
	L 45	G6050451/2	226	250	266	275	311	360	387
	L 60	G6050601/2	254	288	309	318	364	438	451
 <p>1 anta vetro 1 glass door</p>	<p>telaio polimerico L 45 polymeric frame</p>	G6180451/2	—	322	339	—	—	—	—
	L 60	G6180601/2	—	381	403	—	—	—	—
	<p>telaio alluminio 419S L 45 aluminium frame</p>	G6182451/2	363	363	363	363	363	363	—
	L 60	G6182601/2	407	407	407	407	407	407	—
 <p>1 anta integrata al gruppo cestelli estraibili in filo cromati chiusura soft 1 door incorporated into the chromed wire pull-out basket drawer unit soft-closing system</p>	L 30	G6150300	450	463	474	477	500	529	560
 <p>1 anta gruppo cestelli estraibili in filo cromati chiusura soft 1 door chromed wire pull-out basket drawer unit soft-closing system</p>	L 45	G6150451/2	474	497	512	520	555	600	626
	L 60	G6150601/2	517	550	569	578	621	691	704
 <p>1 anta vetro gruppo cestelli estraibili in filo cromati chiusura soft 1 glass door chromed wire pull-out basket drawer unit soft-closing system</p>	<p>telaio polimerico L 45 polymeric frame</p>	G6152451/2	—	586	603	—	—	—	—
	L 60	G6152601/2	—	664	686	—	—	—	—
	<p>telaio alluminio 419S L 45 aluminium frame</p>	G6152461/2	641	641	641	641	641	641	—
	L 60	G6152611/2	703	703	703	703	703	703	—

COLONNE H 145

P 59,7

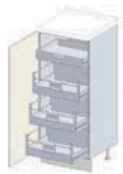



COLUMNS H 145

Le colonne non sono comprensive di top - N.B.: cerniere ammortizzate di serie The columns do not include the tops - Note: standard blumotion hinges	COD.	MELAMINICO	POLIMERICO		LACCATO			GLAKS	
		KG6	OPACO KG7	LUCIDO KG7	A KG8	B KG8	PELTRO KG8	KG3	
 <p>*1 anta (cerniere 180°) 1 cassetto interno 3 cestoni interni *1 door (180° hinges) 1 internal drawer 3 internal deep drawers</p>	L 45	G6158481/2	508	531	546	555	589	634	660
	L 60	G6158631/2	556	588	608	616	660	729	742
<p>*LE COLONNE CON CASSETTI E CESTONI INTERNI VANNO SEMPRE POSIZIONATE A 5 CM DALLA PARETE LATERALE *COLUMNS WITH INTERNAL DRAWERS AND DEEP DRAWERS SHOULD ALWAYS BE PLACED 5 CM FROM THE SIDE WALL</p>									
 <p>angolo 2 ripiani 1 anta (cerniere a pilastro) pannello come anta sp.2,2 (pannello finiture legno venature verticali) corner unit 2 shelves 1 door (hinges pillar) panel as door Th. 2,2 (wooden finishes panel with vertical grains)</p>	L 110	G6336101/2	515	463	501	509	595	640	761
	L 125	G6336251/2	530	475	515	521	616	684	793
 <p>angolo 8 cestelli estraibili indipendenti all'anta 1 anta pannello come anta sp.2,2 (pannello finiture legno venature verticali) corner unit 8 pull-out basket units independent from door 1 door panel as door Th. 2,2 (wooden finishes panel with vertical grains)</p>	L 110	G6338101/2	1.364	1.312	1.350	1.358	1.444	1.489	1.610
	L 125	G6338251/2	1.505	1.450	1.490	1.496	1.591	1.659	1.768
<p>NELLE COLONNE PER L'APERTURA DELLE ANTE E' OBBLIGATORIO L'INSERIMENTO DELLE GOLE VERTICALI VERTICAL FINGER RAILS MUST BE FITTED TO COLUMNS WITH OPENING DOORS</p>									

COLONNE H 145

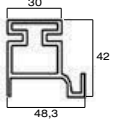
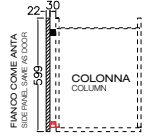
COLUMNS H 145

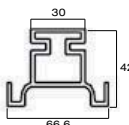
P 59,7

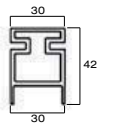
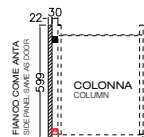



	COD.	MELAMINICO	POLIMERICO		LACCATO			GLAKS	
		KG6	OPACO KG7	LUCIDO KG7	A KG8	B KG8	PELTRO KG8	KG3	
<p>mezza gola verticale tipo "C" H 132 finger rail type "C" H 132</p>   <p>Sezione gola tipo "C" Type "C" finger rail section</p>  <p>FIANCO COME ANTA SIDE PANEL AS DOOR</p> <p>COLONNA COLUMN</p>	gola finger rail	G950330	73	73	73	73	73	73	
	gola con fianco come anta montato finger rail mounted on side panel same as door	G950339	143	226	264	203	247	316	328
<p>gola verticale intermedia tipo "D" H 132 vertical intermediate finger rail type "D" H 132</p>   <p>Sezione gola tipo "D" Type "D" finger rail section</p>	gola finger rail	G950430	73	73	73	73	73	73	
<p>gola verticale laterale tipo "E" H 132 vertical lateral finger rail type "E" H 132</p>   <p>Sezione gola tipo "E" Type "E" finger rail section</p>  <p>FIANCO COME ANTA SIDE PANEL AS DOOR</p> <p>COLONNA COLUMN</p>	gola finger rail	G950530	73	73	73	73	73	73	
	gola con fianco come anta montato finger rail mounted on side panel same as door	G950539	143	226	264	203	247	316	328

COLONNE H 217

P 33,2 - 59,7

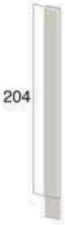
COLUMNS H 217





N.B.: cerniere ammortizzate di serie
Note: standard blumotion hinges

	COD.	MELAMINICO	POLIMERICO		LACCATO			GLAKS	
		KG6	OPACO KG7	LUCIDO KG7	A KG8	B KG8	PELTRO KG8	KG3	
 <p>fascia tamponamento da 5 a 10 N.B.: nelle finiture legno per la versione in polimerico viene realizzata in 2 pezzi filler panel size 5 to 10 Note: produced in 2 pieces for wooden finishes of polymeric version</p>									
	in nobilitato melamine coated	G6000050	47	38	38	38	38	38	38
	come anta con supporto same as door with support	G6000200	130	144	157	168	204	210	205
 <p>2 ante anta superiore H 72 anta inferiore H 132 2 doors upper door H 72 lower door H 132</p>	L 45 P 33,2	G6013451/2	276	313	339	347	403	483	531
	L 60 P 33,2	G6013601/2	325	381	415	426	502	623	649
 <p>2 ante anta superiore H 72 anta inferiore H 132 2 doors upper door H 72 lower door H 132</p>	L 30 P 59,7	G6060301/2	294	314	333	333	371	422	480
	L 45 P 59,7	G6063451/2	328	364	390	398	455	534	583
	L 60 P 59,7	G6063601/2	385	441	476	486	562	684	710
 <p>2 ante anta superiore H 132 anta inferiore H 72 2 doors upper door H 132 lower door H 72</p>	L 45 P 33,2	G6010451/2	276	313	339	347	403	483	531
	L 60 P 33,2	G6010601/2	325	381	415	426	502	623	649
 <p>2 ante anta superiore H 132 anta inferiore H 72 2 doors upper door H 132 lower door H 72</p>	L 45 P 59,7	G6060451/2	328	364	390	398	455	534	583
	L 60 P 59,7	G6060601/2	385	441	476	486	562	684	710
<p>NELLE COLONNE PER L'APERTURA DELLE ANTE E' OBBLIGATORIO L'INSERIMENTO DELLE GOLE VERTICALI VERTICAL FINGER RAILS MUST BE FITTED TO COLUMNS WITH OPENING DOORS</p>									

COLONNE H 217

COLUMNS H 217

P 59,7

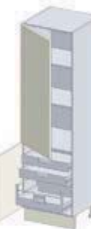
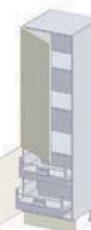



	COD.	MELAMINICO	POLIMERICO		LACCATO			GLAKS	
		KG6	OPACO KG7	LUCIDO KG7	A KG8	B KG8	PELTRO KG8	KG3	
 <p>1 anta H 204 N.B.: non disponibile per le finiture legno nella versione polimerico 1 door H 204 Note: Not available for wooden finishes of polymeric version</p>	L 45	G6061451/2	322	374	399	403	459	540	592
	L 60	G6061601/2	364	430	463	477	555	669	708
 <p>portascope 2 ante anta superiore H 72 anta inferiore H 132 broom cabinet 2 doors upper door H 72 lower door H 132</p>	L 30	G6100301/2	302	323	342	341	379	430	488
	L 45	G6100451/2	323	360	386	394	450	529	578
 <p>portascope con ripiani 2 ante anta superiore H 72 anta inferiore H 132 broom cabinet with shelves 2 doors upper door H 72 lower door H 132</p>	L 60	G6100601/2	398	453	488	499	575	696	722
 <p>*1 anta superiore H 132 (cerniere 100°) 1 anta inferiore H 72 (cerniere 180°) 4 cassetti interni *1 upper door H 132 (100° hinges) 1 lower door H 72 (180° hinges) 4 internal drawers</p>	L 45	G6065451/2	533	566	590	598	649	722	769
	L 60	G6065601/2	594	643	674	683	750	856	883
 <p>*1 anta superiore H 132 (cerniere 100°) 1 anta inferiore H 72 (cerniere 180°) 2 cassetti interni 1 cestone interno *1 upper door H 132 (100° hinges) 1 lower door H 72 (180° hinges) 2 internal drawers 1 internal deep drawer</p>	L 45	G6065461/2	485	519	542	550	601	674	721
	L 60	G6065611/2	537	586	616	626	692	799	825
 <p>*1 anta superiore H 132 (cerniere 100°) 1 anta inferiore H 72 (cerniere 180°) 2 cestoni interni *1 upper door H 132 (100° hinges) 1 lower door H 72 (180° hinges) 2 internal deep drawers</p>	L 45 P 59,7	G6066451/2	437	471	494	502	553	626	673
	L 60 P 59,7	G6066601/2	490	539	570	579	645	752	778

COLONNE H 217

COLUMNS H 217

P 33,2 - 59,7





N.B.: cerniere ammortizzate di serie
Note: standard blumotion hinges

	COD.	MELAMINICO	POLIMERICO		LACCATO			GLAKS	
		KG6	OPACO KG7	LUCIDO KG7	A KG8	B KG8	PELTRO KG8	KG3	
 <p>2 ante vetro anta superiore H 132 anta inferiore H 72 2 glass doors upper door H 132 lower door H 72</p>									
	telaio polimerico L 45 P 33,2 polymeric frame	G6200461/2	—	439	465	—	—	—	—
	L 60 P 33,2	G6200611/2	—	527	562	—	—	—	—
	telaio alluminio 419S L 45 P 33,2 aluminium frame	G6203461/2	541	541	541	541	541	541	—
	L 60 P 33,2	G6203611/2	578	578	578	578	578	578	—
 <p>2 ante vetro anta superiore H 132 anta inferiore H 72 2 glass doors upper door H 132 lower door H 72</p>									
	telaio polimerico L 45 P 59,7 polymeric frame	G6200451/2	—	486	513	—	—	—	—
	L 60 P 59,7	G6200601/2	—	578	613	—	—	—	—
	telaio alluminio 419S L 45 P 59,7 aluminium frame	G6203451/2	557	557	557	557	557	557	—
	L 60 P 59,7	G6203601/2	629	629	629	629	629	629	—
 <p>2 ante anta vetro H 132 anta chiusa H 72 2 doors glass door H 132 full door H 72</p>									
	telaio polimerico L 45 P 33,2 polymeric frame	G6202451/2	—	377	403	—	—	—	—
	L 60 P 33,2	G6202601/2	—	448	481	—	—	—	—
	telaio alluminio 419S L 45 P 33,2 aluminium frame	G6205451/2	387	392	401	400	418	445	—
	L 60 P 33,2	G6205601/2	436	447	458	459	482	520	—
 <p>2 ante anta vetro H 132 anta chiusa H 72 2 doors glass door H 132 full door H 72</p>									
	telaio polimerico L 45 P 59,7 polymeric frame	G6201451/2	—	423	448	—	—	—	—
	L 60 P 59,7	G6201601/2	—	499	533	—	—	—	—
	telaio alluminio 419S L 45 P 59,7 aluminium frame	G6204451/2	433	438	447	446	463	491	—
	L 60 P 59,7	G6204601/2	487	498	509	510	534	571	—
<p>NELLE COLONNE PER L'APERTURA DELLE ANTE E' OBBLIGATORIO L'INSERIMENTO DELLE GOLE VERTICALI VERTICAL FINGER RAILS MUST BE FITTED TO COLUMNS WITH OPENING DOORS</p>									
<p>*LE COLONNE CON CASSETTI E CESTONI INTERNI VANNO SEMPRE POSIZIONATE A 5 CM DALLA PARETE LATERALE *COLUMNS WITH INTERNAL DRAWERS AND DEEP DRAWERS SHOULD ALWAYS BE PLACED 5 CM FROM THE SIDE WALL</p>									

COLONNE H 217

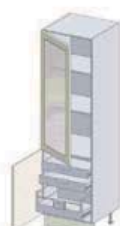
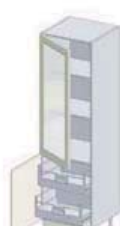
COLUMNS H 217

P 59,7



	COD.	MELA-MINICO	POLIMERICO		LACCATO			GLAKS	
		KG6	OPACO KG7	LUCIDO KG7	A KG8	B KG8	PELTRO KG8	KG3	
 <p>*1 anta vetro superiore H 132 1 anta inferiore H 72 4 cassetti interni *1 upper glass door H 132 1 lower door H 72 4 internal drawers</p>									
	telaio polimerico L 45 polymeric frame	G6284451/2	—	655	681	—	—	—	—
	L 60	G6284601/2	—	750	783	—	—	—	—
	telaio alluminio 419S L 45 aluminium frame	G6287451/2	672	682	691	690	708	735	—
	L 60	G6287601/2	746	762	774	774	798	836	—
 <p>*1 anta vetro superiore H 132 1 anta inferiore H 72 2 cassetti interni 1 cestone interno *1 upper glass door H 132 1 lower door H 72 2 internal drawers 1 internal deep drawer</p>									
	telaio polimerico L 45 polymeric frame	G6284461/2	—	607	633	—	—	—	—
	L 60	G6284611/2	—	699	733	—	—	—	—
	telaio alluminio 419S L 45 aluminium frame	G6287461/2	624	634	643	642	660	687	—
	L 60	G6287611/2	693	710	721	722	745	783	—
 <p>*1 anta vetro superiore H 132 1 anta inferiore H 72 2 cestoni interni *1 upper glass door H 132 1 lower door H 72 2 internal deep drawers</p>									
	telaio polimerico L 45 polymeric frame	G6285451/2	—	559	585	—	—	—	—
	L 60	G6285601/2	—	653	686	—	—	—	—
	telaio alluminio 419S L 45 aluminium frame	G6288451/2	576	586	595	594	612	639	—
	L 60	G6288601/2	642	658	669	670	694	731	—
 <p>anta H 204 integrata al gruppo cestelli estraibili in filo cromati chiusura soft N.B.: non disponibile per le finiture legno nella versione polimerico door H 204 incorporated into the chromed wire pull-out basket unit soft-closing system Note: Not available for wooden finishes of polymeric version</p>									
	L 30	G6163300	609	646	659	657	692	737	780
	L 45	G6163450	660	710	731	735	787	862	902
 <p>anta H 204 unite (132+72) integrata al gruppo cestelli estraibili in filo cromati chiusura soft N.B.: disponibile per le finiture legno nella versione polimerico joint doors H 204 (132+72) incorporated into the chromed wire pull-out basket drawer unit soft-closing system Note: available for wooden finishes of polymeric version</p>									
	L 30	G6164300	—	658	671	—	—	—	—
	L 45	G6164450	—	725	745	—	—	—	—
 <p>1 anta superiore H 72 1 anta H 132 integrata al gruppo cestelli estraibili in filo cromati chiusura soft 1 upper door H 72 1 door H 132 incorporated into the chromed wire pull-out basket drawer unit soft-closing system</p>									
	L 30	G6160301/2	533	552	570	569	605	652	705

COLONNE H 217

COLUMNS H 217

P 59,7

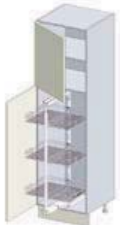
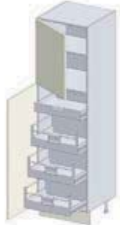

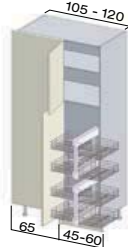

N.B.: cerniere ammortizzate di serie
Note: standard blumotion hinges

	COD.	MELAMINICO	POLIMERICO		LACCATO			GLAKS	
		KG6	OPACO KG7	LUCIDO KG7	A KG8	B KG8	PELTRO KG8	KG3	
 <p>1 anta superiore H 72 1 anta inferiore H 132 gruppo cestelli estraibili in filo cromati chiusura soft 1 upper door H 72 1 lower door H 132 chromed wire pull-out basket drawer unit soft-closing system</p>	L 45	G6160451/2	572	606	630	637	690	763	808
	L 60	G6160601/2	628	677	708	717	785	892	915
 <p>1 anta superiore H 72 (cerniere 100°) 1 anta inferiore H 132 (cerniere 180°) 1 cassetto interno 3 cestoni interni posizionare sempre a 5 cm dalla parete laterale 1 upper door H 72 (100° hinges) 1 lower door H 132 (180° hinges) 1 internal drawer 3 internal deep drawers <i>should always be placed at 5 cm from the side wall</i></p>	L 45	G6080481/2	578	612	635	643	695	767	812
	L 60	G6080631/2	637	686	716	726	792	899	922
 <p>angolo 4 ripiani 1 anta superiore H 72 (cerniere 180°) 1 anta inferiore H 132 (cerniere a pilastro) pannello come anta sp.2,2 (pannello finiture legno venature verticali) corner unit 4 shelves 1 upper door H 72 (180° hinges) 1 lower door H 132 (pillar hinges) panel as door Th. 2,2 <i>(wooden finishes panel with vertical grains)</i></p>	L 110	G6306101/2	652	679	737	744	875	947	1.135
	L 125	G6306251/2	668	690	750	764	909	1.016	1.182
 <p>angolo 8 cestelli estraibili 1 anta superiore H 72 (cerniere 180°) 1 anta inferiore H 132 pannello come anta sp.2,2 (pannello finiture legno venature verticali) corner unit 8 pull-out basket drawers 1 upper door H 72 (180° hinges) 1 lower door H 132 panel as door Th. 2,2 <i>(wooden finishes panel with vertical grains)</i></p>	L 110	G6308101/2	1.501	1.528	1.586	1.593	1.724	1.796	1.984
	L 125	G6308251/2	1.643	1.665	1.725	1.739	1.884	1.991	2.157
<p>NELLE COLONNE PER L'APERTURA DELLE ANTE E' OBBLIGATORIO L'INSERIMENTO DELLE GOLE VERTICALI VERTICAL FINGER RAILS MUST BE FITTED TO COLUMNS WITH OPENING DOORS</p>									

COLONNE H 217

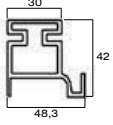
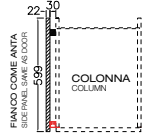
COLUMNS H 217

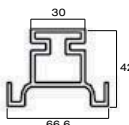
P 59,7

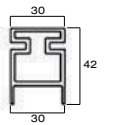
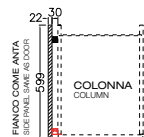



	COD.	MELAMINICO	POLIMERICO		LACCATO			GLAKS	
		KG6	OPACO KG7	LUCIDO KG7	A KG8	B KG8	PELTRO KG8	KG3	
<p>mezza gola verticale tipo "C" H 204 finger rail type "C" H 204</p>   <p>Sezione gola tipo "C" Type "C" finger rail section</p>  <p>FIANCO COME ANTA SIDE PANEL AS DOOR</p> <p>COLONNA COLUMN</p>									
		gola finger rail	G950350	108	108	108	108	108	108
		gola con fianco come anta montato finger rail mounted on side panel same as door	G950359	206	333	391	310	379	479
<p>gola verticale intermedia tipo "D" H 204 vertical intermediate finger rail type "D" H 204</p>   <p>Sezione gola tipo "D" Type "D" finger rail section</p>									
		gola finger rail	G950450	108	108	108	108	108	108
<p>gola verticale laterale tipo "E" H 204 vertical lateral finger rail type "E" H 204</p>   <p>Sezione gola tipo "E" Type "E" finger rail section</p>  <p>FIANCO COME ANTA SIDE PANEL AS DOOR</p> <p>COLONNA COLUMN</p>									
		gola finger rail	G950550	108	108	108	108	108	108
		gola con fianco come anta montato finger rail mounted on side panel same as door	G950359	206	333	391	310	379	479

COLONNE H 241

COLUMNS H 241

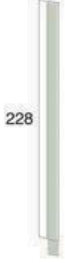
P 33,2 - 59,7





N.B.: cerniere ammortizzate di serie
Note: standard blumotion hinges

	COD.	MELA-MINICO	POLIMERICO		LACCATO			GLAKS	
		KG6	OPACO KG7	LUCIDO KG7	A KG8	B KG8	PELTRO KG8	KG3	
 <p>fascia tamponamento da 5 a 10 N.B.: nelle finiture legno per la versione in polimerico viene realizzata in 2 pezzi filler panel size 5 to 10 Note: produced in 2 pieces for wooden finishes of polymeric version</p>									
	in nobilitato melamine coated	G6000100	38	38	38	38	38	38	38
	come anta con supporto same as door with support	G6000250	135	150	166	169	204	214	211
 <p>2 ante anta superiore H 96 anta inferiore H 132 2 doors upper door H 96 lower door H 132</p>	L 45 P 33,2	G6023451/2	302	343	372	382	445	534	581
	L 60 P 33,2	G6023601/2	360	422	460	474	559	695	720
 <p>2 ante anta superiore H 96 anta inferiore H 132 2 doors upper door H 96 lower door H 132</p>	L 30 P 59,7	G6070301/2	319	342	363	364	406	463	516
	L 45 P 59,7	G6073451/2	358	399	428	438	501	590	637
	L 60 P 59,7	G6073601/2	426	488	527	541	626	761	786
 <p>2 ante anta superiore H 156 (anta unita 132+24 nelle finiture legno per la versione polimerico) anta inferiore H 72 2 doors upper door H 156 <i>(joint doors 132+24 for wooden finishes of polymeric version)</i> lower door H 72</p>	L 45 P 33,2	G6020451/2	300	343	372	378	439	534	598
	L 60 P 33,2	G6020601/2	355	418	457	473	558	691	731
 <p>2 ante anta superiore H 156 (anta unita 132+24 nelle finiture legno per la versione polimerico) anta inferiore H 72 2 doors upper door H 156 <i>(joint doors 132+24 for wooden finishes of polymeric version)</i> lower door H 72</p>	L 45 P 59,7	G6070451/2	356	399	428	434	495	590	654
	L 60 P 59,7	G6070601/2	421	485	523	539	625	758	797
<p>NELLE COLONNE PER L'APERTURA DELLE ANTE E' OBBLIGATORIO L'INSERIMENTO DELLE GOLE VERTICALI VERTICAL FINGER RAILS MUST BE FITTED TO COLUMNS WITH OPENING DOORS</p>									

COLONNE H 241

COLUMNS H 241

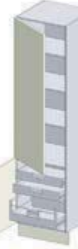
P 59,7





	COD.	MELAMINICO	POLIMERICO		LACCATO			GLAKS	
		KG6	OPACO KG7	LUCIDO KG7	A KG8	B KG8	PELTRO KG8	KG3	
 <p>portascope 1 anta superiore H 96 1 anta inferiore H 132 broom cabinet 1 upper door H 96 1 lower door H 132</p>	L 30 P 59,7	G6110301/2	335	357	378	379	421	479	531
	L 45 P 59,7	G6110451/2	354	395	424	434	496	586	633
	L 60 P 59,7	G6110601/2	426	488	526	540	625	761	786
 <p>portascope con ripiani 1 anta superiore H 96 1 anta inferiore H 132 broom cabinet with shelves 1 upper door H 96 1 lower door H 132</p>	L 60 P 59,7	G6110601/2	426	488	526	540	625	761	786
	L 45 P 59,7	G6075451/2	558	598	624	630	686	773	834
	L 60 P 59,7	G6075601/2	620	676	710	724	799	915	953
 <p>*1 anta superiore H 156 (cerniere 100°) (anta unita 132+24 nelle finiture legno per la versione polimerico) 1 anta inferiore H 72 (cerniere 180°) 4 cassetti interni *1 upper door H 156 (100° hinges) <i>(joint doors 132+24 for wooden finishes of polymeric version)</i> 1 lower door H 72 (180° hinges) 4 internal drawers</p>	L 45 P 59,7	G6075451/2	558	598	624	630	686	773	834
	L 60 P 59,7	G6075601/2	620	676	710	724	799	915	953
	L 45 P 59,7	G6075461/2	510	550	576	582	638	725	786
 <p>*1 anta superiore H 156 (cerniere 100°) (anta unita 132+24 nelle finiture legno per la versione polimerico) 1 anta inferiore H 72 (cerniere 180°) 2 cassetti interni 1 cestone interno *1 upper door H 156 (100° hinges) <i>(joint doors 132+24 for wooden finishes of polymeric version)</i> 1 lower door H 72 (180° hinges) 2 internal drawers 1 internal deep drawer</p>	L 45 P 59,7	G6075461/2	510	550	576	582	638	725	786
	L 60 P 59,7	G6075611/2	568	624	658	672	747	863	901
	L 45 P 59,7	G6076451/2	462	502	529	534	590	677	738
 <p>*1 anta superiore H 156 (cerniere 100°) (anta unita 132+24 nelle finiture legno per la versione polimerico) 1 anta inferiore H 72 (cerniere 180°) 2 cestoni interni 1 door H 156 (100° hinges) <i>(joint doors 132+24 for wooden finishes of polymeric version)</i> 1 lower door H 72 (180° hinges) 2 deep drawers H 36</p>	L 60 P 59,7	G6076601/2	516	572	606	620	695	811	849
	L 45 P 59,7	G6076451/2	462	502	529	534	590	677	738
<p>NELLE COLONNE PER L'APERTURA DELLE ANTE E' OBBLIGATORIO L'INSERIMENTO DELLE GOLE VERTICALI *LE COLONNE CON CASSETTI E CESTONI INTERNI VANNO SEMPRE POSIZIONATE A 5 CM DALLA PARETE LATERALE <i>VERTICAL FINGER RAILS MUST BE FITTED TO COLUMNS WITH OPENING DOORS</i> <i>*COLUMNS WITH INTERNAL DRAWERS AND DEEP DRAWERS SHOULD ALWAYS BE PLACED 5 CM FROM THE SIDE WALL</i></p>									

COLONNE H 241

P 33,2 - 59,7

COLUMNS H 241

N.B.: cassetti e cestoni ad estrazione totale con blumotion
 Note: fully extending drawers and deep drawers with blumotion system







	COD.	MELAMINICO	POLIMERICO		LACCATO			GLAKS	
		KG6	OPACO KG7	LUCIDO KG7	A KG8	B KG8	PELTRO KG8	KG3	
 <p>2 ante vetro anta superiore H 156 (anta unita 132 vetro+24 piena nelle finiture legno per la versione polimerico) anta inferiore H 72 2 glass doors upper door H 156 (joint glass door 132+full door 24 for wooden finishes of polymeric version) lower door H 72</p>	telaio polimerico L 45 P 33,2 polymeric frame	G6210461/2	—	484	514	—	—	—	—
	telaio alluminio 419S L 45 P 33,2 aluminium frame	G6213461/2	552	552	552	552	552	552	—
 <p>2 ante vetro anta superiore H 156 (anta unita 132 vetro+24 piena nelle finiture legno per la versione polimerico) anta inferiore H 72 2 glass doors upper door H 156 (joint glass door 132+full door 24 for wooden finishes of polymeric version) lower door H 72</p>	telaio polimerico L 45 P 59,7 polymeric frame	G6210451/2	—	536	566	—	—	—	—
	telaio alluminio 419S L 45 P 59,7 aluminium frame	G6213451/2	602	602	602	602	602	602	—
 <p>2 ante anta vetro H 156 (anta unita 132 vetro+24 piena nelle finiture legno per la versione polimerico) anta chiusa H 72 2 doors glass door H 156 (joint glass door 132+full door 24 for wooden finishes of polymeric version) full door H 72</p>	telaio polimerico L 45 P 33,2 polymeric frame	G6212451/2	—	421	450	—	—	—	—
	telaio alluminio 419S L 45 P 33,2 aluminium frame	G6215451/2	426	437	440	439	456	484	—
 <p>2 ante anta vetro H 156 (anta unita 132 vetro+24 piena nelle finiture legno per la versione polimerico) anta chiusa H 72 2 doors glass door H 156 (joint glass door 132+full door 24 for wooden finishes of polymeric version) full door H 72</p>	telaio polimerico L 45 P 59,7 polymeric frame	G6211451/2	—	473	501	—	—	—	—
	telaio alluminio 419S L 45 P 59,7 aluminium frame	G6214451/2	478	489	491	490	508	535	—
<p>NELLE COLONNE PER L'APERTURA DELLE ANTE E' OBBLIGATORIO L'INSERIMENTO DELLE GOLE VERTICALI VERTICAL FINGER RAILS MUST BE FITTED TO COLUMNS WITH OPENING DOORS</p>									

COLONNE H 241

COLUMNS H 241

P 59,7

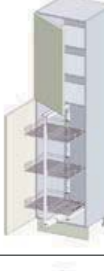
N.B.: nelle colonne per l'apertura delle ante è obbligatorio l'inserimento delle gole verticali
 Note: vertical finger rails must be fitted to columns with opening doors

	COD.	MELAMINICO	POLIMERICICO		LACCATO			GLAKS
		KG6	OPACO KG7	LUCIDO KG7	A KG8	B KG8	PELTRO KG8	KG3
 <p>1 anta vetro superiore H 156 (anta unita 132 vetro+24 piena nelle finiture legno per la versione polimerico) 1 anta inferiore H 72 4 cassetti interni posizionare sempre a 5 cm dalla parete laterale 1 upper glass door H 156 (joint glass door 132+full door 24 for wooden finishes of polymeric version) 1 lower door H 72 4 internal drawers should always be placed at 5 cm from the side wall</p> <p>telaio polimerico L 45 P 59,7 polymeric frame telaio alluminio 419S L 45 P 59,7 aluminium frame</p>								
	G6294451/2	—	705	733	—	—	—	—
G6297451/2	716	727	736	735	752	780	—	
 <p>1 anta vetro superiore H 156 (anta unita 132 vetro+24 piena nelle finiture legno per la versione polimerico) 1 anta inferiore H 72 2 cassetti interni 1 cestone interno posizionare sempre a 5 cm dalla parete laterale 1 upper glass door H 156 (joint glass door 132+full door 24 for wooden finishes of polymeric version) 1 lower door H 72 2 internal drawers 1 internal deep drawer should always be placed at 5 cm from the side wall</p> <p>telaio polimerico L 45 P 59,7 polymeric frame telaio alluminio 419S L 45 P 59,7 aluminium frame</p>								
	G6294461/2	—	657	685	—	—	—	—
G6297461/2	668	679	688	687	704	732	—	
 <p>1 anta vetro superiore H 156 (anta unita 132 vetro+24 piena nelle finiture legno per la versione polimerico) 1 anta inferiore H 72 2 cestoni interni posizionare sempre a 5 cm dalla parete laterale 1 upper glass door H 156 (joint glass door 132+full door 24 for wooden finishes of polymeric version) 1 lower door H 72 2 internal deep drawers should always be placed at 5 cm from the side wall</p> <p>telaio polimerico L 45 polymeric frame telaio alluminio 419S L 45 aluminium frame</p>								
	G6296451/2	—	609	637	—	—	—	—
G6298451/2	620	631	640	639	656	684	—	
 <p>1 anta superiore H 96 1 anta H 132 integrata al gruppo cestelli estraibili in filo cromati chiusura soft 1 upper door H 96 1 door H 132 incorporated into the chromed wire pull-out basket drawer unit soft-closing system</p>	L 30							
	G6170301/2	557	578	598	598	637	691	739
 <p>1 anta superiore H 96 1 anta inferiore H 132 gruppo cestelli estraibili in filo cromati chiusura soft 1 upper door H 96 1 lower door H 132 chromed wire pull-out basket drawer unit soft-closing system</p>	L 45							
	G6170451/2	600	638	665	674	732	815	859
L 60	G6170601/2	665	720	754	766	841	961	982
 <p>1 anta superiore H 96 (cerniere 100°) 1 anta inferiore H 132 (cerniere 180°) 1 cassetto interno 3 cestoni interni posizionare sempre a 5 cm dalla parete laterale 1 upper door H 96 (100° hinges) 1 lower door H 132 (180° hinges) 1 internal drawer 3 internal deep drawers should always be placed at 5 cm from the side wall</p>	L 45							
	G6082481/2	606	643	670	679	737	819	862
L 60	G6082631/2	673	727	761	773	848	967	989

COLONNE ANGOLO H 241

P 59,7

CORNER COLUMNS H 241



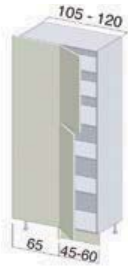
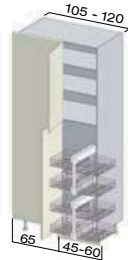

N.B.: cerniere ammortizzate di serie
Note: standard blumotion hinges

	COD.	MELA-MINICO	POLIMERICO		LACCATO			GLAKS	
		KG6	OPACO KG7	LUCIDO KG7	A KG8	B KG8	PELTRO KG8	KG3	
 <p>angolo 5 ripiani 1 anta superiore H 96 1 anta inferiore H 132 (cerniere a pilastro) pannello come anta sp. 2,2 (pannello finiture legno venature verticali) corner unit 5 shelves 1 upper door H 96 1 lower door H 132 (pillar hinges) panel as door Th. 2,2 (wooden finishes panel with vertical grains)</p>	L 110	G6316101/2	693	743	808	820	964	1.046	1.207
	L 125	G6316251/2	717	760	831	851	1.012	1.131	1.271
 <p>angolo 8 cestelli estraibili indipendenti all'anta 1 anta superiore H 96 (cerniere 180°) 1 anta inferiore H 132 pannello come anta sp. 2,2 (pannello finiture legno venature verticali) corner unit 8 pull-out basket units independent from door 1 upper door H 96 (180° hinges) 1 lower door H 132 panel as door Th. 2,2 (wooden finishes panel with vertical grains)</p>	L 110	G6318101/2	1.542	1.592	1.657	1.669	1.813	1.895	2.056
	L 125	G6318251/2	1.692	1.735	1.806	1.826	1.987	2.106	2.246
<p>NELLE COLONNE PER L'APERTURA DELLE ANTE E' OBBLIGATORIO L'INSERIMENTO DELLE GOLE VERTICALI VERTICAL FINGER RAILS MUST BE FITTED TO COLUMNS WITH OPENING DOORS</p>									

COLONNE H 241

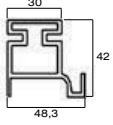
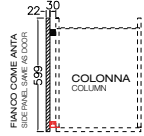
COLUMNS H 241

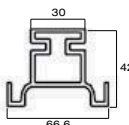
P 59,7

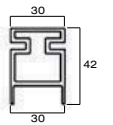
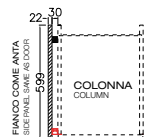



	COD.	MELAMINICO	POLIMERICO		LACCATO			GLAKS	
		KG6	OPACO KG7	LUCIDO KG7	A KG8	B KG8	PELTRO KG8	KG3	
<p>mezza gola verticale tipo "C" H 228 finger rail type "C" H 228</p>   <p>Sezione gola tipo "C" Type "C" finger rail section</p> 									
		gola finger rail	G950370	116	116	116	116	116	116
		gola con fianco come anta montato finger rail mounted on side panel same as door	G950379	226	360	425	342	387	535
<p>gola verticale intermedia tipo "D" H 228 vertical intermediate finger rail type "D" H 228</p>   <p>Sezione gola tipo "D" Type "D" finger rail section</p>									
		gola finger rail	G950470	116	116	116	116	116	116
<p>gola verticale laterale tipo "E" H 228 vertical lateral finger rail type "E" H 228</p>   <p>Sezione gola tipo "E" Type "E" finger rail section</p> 									
		gola finger rail	G950570	116	116	116	116	116	116
		gola con fianco come anta montato finger rail mounted on side panel same as door	G950579	226	360	425	342	387	535

COLONNE H 109 - 128 PER FORNO

P 59,7

OVEN COLUMNS H 109 - 128

Le colonne non sono comprensive di top - N.B.: cassetti e cestoni ad estrazione totale con blumotion
 The columns do not include the tops - **Note: fully extending drawers and deep drawers with blumotion system**

	COD.	MELAMINICO	POLIMERICO		LACCATO			GLAKS
		KG6	OPACO KG7	LUCIDO KG7	A KG8	B KG8	PELTRO KG8	KG3
colonna H 109 per forno 1 cestone chiuso H 36 oven column H 109 1 full deep drawer H 36 								
	L 60	G6501600	238	240	246	249	261	278
colonna H 128 per forno con gola orizzontale 1 cassetto H 16,9 1 cestone H 34,2 oven column H 128 with horizontal finger rail 1 drawer H 16,9 1 deep drawer H 34,2 N.B.: colonna da utilizzare con basi cestoni Note: column to use with deep drawer base units 								
	L 60	G6510600	333	340	350	348	368	399
top in laminato H 4 P 61 per colonne laminate top H 4 D 61 for columns 								
			VEDI	VEDI	VEDI	VEDI	VEDI	VEDI
	al ml per lm	T90135	LISTINO	LISTINO	LISTINO	LISTINO	LISTINO	LISTINO
			mag.griglia di areazione cad. surcharge for ventilation grille each					
			TOP	TOP	TOP	TOP	TOP	TOP
kit protezione fianchi per forno protection kit sides for oven 								
	coppia couple	08630095	16	16	16	16	16	16

COLONNE PER FORNO H 145

P 59,7

OVEN COLUMNS H 145

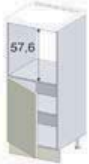
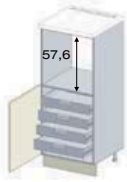
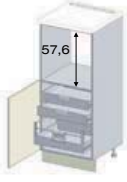
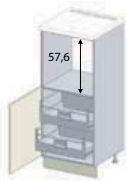
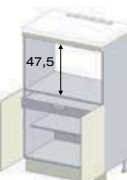

Le colonne non sono comprensive di top - N.B.: cerniere ammortizzate di serie The columns do not include the tops - Note: standard blumotion hinges		COD.	MELA-MINICO	POLIMERICO		LACCATO			GLAKS
			KG6	OPACO KG7	LUCIDO KG7	A KG8	B KG8	PELTRO KG8	KG3
 <p>colonna H 145 per forno 1 anta H 72 oven column H 145 1 door H 72</p>	L 60	G6520601/2	240	251	268	269	294	333	344
		 <p>*colonna H 145 per forno 1 anta H 72 apertura push-pull (cerniere 180°) 4 cassetti interni *oven column H 145 1 door H 72 push-pull opening (180°hinges) 4 internal drawers</p>	L 60	G6521611/2	480	497	508	509	533
 <p>*colonna H 145 per forno 1 anta H 72 apertura push-pull (cerniere 180°) 2 cassetti interni 1 cestone interno *oven column H 145 1 door H 72 push-pull opening (180°hinges) 2 internal drawers 1 internal deep drawer</p>	L 60	G6521621/2		428	445	456	457	480	518
 <p>*colonna H 145 per forno 1 anta H 72 apertura push-pull (cerniere 180°) 2 cestoni interni *oven column H 145 1 door H 72 push-pull opening (180°hinges) 2 internal deep drawers</p>		L 60	G6521631/2	379	396	407	408	431	469
 <p>*colonna H 145 per forno per maxiforno H 48 1 cassetto interno 2 ante H 72 apertura push-pull (cerniere 180°) *oven column H 145 for maxi-oven H 48 1 internal drawer 2 doors H 72 push-pull opening (180°hinges)</p>	L 90		G6521950	458	457	481	488	540	623
<p>*LE COLONNE CON CASSETTI E CESTONI INTERNI VANNO SEMPRE POSIZIONATE A 5 CM DALLA PARETE LATERALE *COLUMNS WITH INTERNAL DRAWERS AND DEEP DRAWERS SHOULD ALWAYS BE PLACED 5 CM FROM THE SIDE WALL</p>									

COLONNE PER FORNO H 217

P 59,7

OVEN COLUMNS H 217

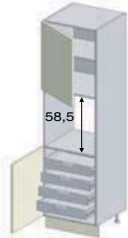
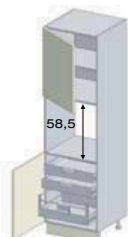
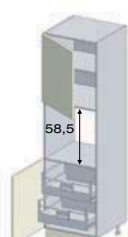





N.B.: cassetti e cestoni ad estrazione totale con blumotion
 Note: fully extending drawers and deep drawers with blumotion system

	COD.	MELAMINICO	POLIMERICO		LACCATO			GLAKS	
		KG6	OPACO KG7	LUCIDO KG7	A KG8	B KG8	PELTRO KG8	KG3	
 <p>colonna per forno apertura push-pull 1 anta superiore H 72 1 anta inferiore H 72 oven column push-pull opening 1 upper door H 72 1 lower door H 72</p>	L 60	G6530601/2	351	385	408	410	459	538	560
 <p>*colonna per forno apertura push-pull 1 anta superiore H 72 1 anta inferiore H 72 (cerniere 180°) 4 cassetti interni *oven column push-pull opening 1 upper door H 72 1 lower door H 72 (180° hinges) 4 internal drawers</p>	L 60	G6531611/2	603	636	658	670	707	783	804
 <p>*colonna per forno push-pull opening 1 anta superiore H 72 1 anta inferiore H 72 (cerniere 180°) 2 cassetti interni 1 cestone interno *oven column push-pull opening 1 upper door H 72 1 lower door H 72 (180° hinges) 2 internal drawers 1 internal deep drawer</p>	L 60	G6531621/2	550	583	606	607	655	730	752
 <p>*colonna per forno apertura push-pull 1 anta superiore H 72 1 anta inferiore H 72 (cerniere 180°) 2 cestoni interni *oven column push-pull opening 1 upper door H 72 1 lower door H 72 (180° hinges) 2 internal deep drawers</p>	L 60	G6531631/2	498	531	553	555	602	678	699
 <p>kit protezione fianchi per forno protection kit sides for oven</p> 	coppia couple	08630095	16	16	16	16	16	16	16
<p>*LE COLONNE CON CASSETTI E CESTONI INTERNI VANNO SEMPRE POSIZIONATE A 5 CM DALLA PARETE LATERALE *COLUMNS WITH INTERNAL DRAWERS AND DEEP DRAWERS SHOULD ALWAYS BE PLACED 5 CM FROM THE SIDE WALL</p>									

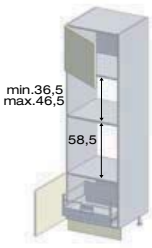
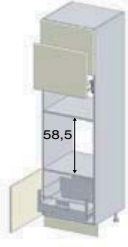
COLONNE PER FORNO H 217

P 59,7

OVEN COLUMNS H 217

	COD.	MELA-MINICO	POLIMERICICO		LACCATO			GLAKS	
		KG6	OPACO KG7	LUCIDO KG7	A KG8	B KG8	PELTRO KG8	KG3	
 <p>*colonna per forno e micro apertura push-pull 1 anta superiore H 48 1 anta inferiore H 48 (cerniere 180°) 1 cestone interno vano micro da H 36,5 a 46,5</p> <p><i>*oven and microwave column push-pull opening 1 upper door H 48 1 lower door H 48 (180° hinges) 1 internal deep drawer microwave compartment H 36,5 to 46,5</i></p>	L 60	G6551611/2	455	474	494	491	531	599	640
 <p>*colonna per forno 1 anta superiore H 48 1 anta H 48 sollevamento verticale 1 anta inferiore H 48 (cerniere 180°) 1 cestone interno</p> <p>N.B.: in base alla composizione è obbligatorio inserire nella colonna con anta sollevamento verticale, gola tipo "D" o "C" per permettere l'apertura della stessa</p> <p><i>*oven column 1 upper door H 48 1 door H 48 vertical opening 1 lower door H 48 (180° hinges) 1 internal deep drawer</i></p> <p>Note: based on the composition, a type "D" or "C" finger rail must be fitted to the column with vertical opening door to allow it to open</p>	L 60	G6554601/2	634	614	639	634	684	760	873
 <p>colonna per forno e lavastoviglie Rex TTC 1003 1 anta superiore H 48 anta lavastoviglie H 72 cassetto H 24</p> <p>N.B.: in base alla composizione è obbligatorio inserire nella colonna con lavastoviglie, gola tipo "D" o "C" per permettere l'apertura della stessa</p> <p><i>column for oven and REX TTC 1003 dishwasher 1 upper door H 48 dishwasher door H 72 drawer H 24</i></p> <p>Note: based on the composition, a type "D" or "C" finger rail must be fitted to the column with dishwasher to allow it to open</p>	L 60	G6883601/2	456	420	443	444	493	562	614
 <p>profilo in acciaio a "L" per rifinire il ripiano del forno e microonde L-shaped steel finishing profile for oven shelf and microwave</p> 	L 60	08660100	9	9	9	9	9	9	9
 <p>kit protezione fianchi per forno protection kit sides for oven</p> 	coppia couple	08630095	16	16	16	16	16	16	16

COLONNE PER FORNO H 241

P 59,7

OVEN COLUMNS H 241

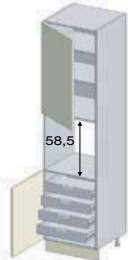
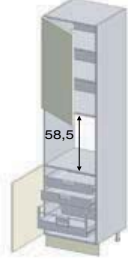
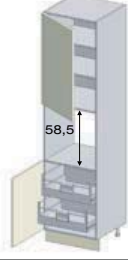

N.B.: cassetti e cestoni ad estrazione totale con blumotion
 Note: fully extending drawers and deep drawers with blumotion system

	COD.	MELA-MINICO	POLIMERICO		LACCATO			GLAKS	
		KG6	OPACO KG7	LUCIDO KG7	A KG8	B KG8	PELTRO KG8	KG3	
 <p>colonna per forno apertura push-pull 1 anta superiore H 96 1 anta inferiore H 72 oven column push-pull opening 1 upper door H 96 1 lower door H 72</p>	L 60	G6540601/2	389	430	456	461	519	610	631
 <p>*colonna per forno apertura push-pull 1 anta superiore H 96 1 anta inferiore H 72 (cerniere 180°) 4 cassetti interni *oven column push-pull opening 1 upper door H 96 1 lower door H 72 (180° hinges) 4 internal drawers</p>	L 60	G6541611/2	640	678	704	709	764	852	873
 <p>*colonna per forno apertura push-pull 1 anta superiore H 96 1 anta inferiore H 72 (cerniere 180°) 2 cassetti interni 1 cestone interno *oven column push-pull opening 1 upper door H 96 1 lower door H 72 (180° hinges) 2 internal drawers 1 internal deep drawer</p>	L 60	G6541621/2	587	626	652	657	712	800	821
 <p>*colonna per forno apertura push-pull 1 anta superiore H 96 1 anta inferiore H 72 (cerniere 180°) 2 cestoni interni *oven column push-pull opening 1 upper door H 96 1 lower door H 72 (180° hinges) 2 internal deep drawers</p>	L 60	G6541631/2	535	574	599	604	659	748	768
<p>*LE COLONNE CON CASSETTI E CESTONI INTERNI VANNO SEMPRE POSIZIONATE A 5 CM DALLA PARETE LATERALE *COLUMNS WITH INTERNAL DRAWERS AND DEEP DRAWERS SHOULD ALWAYS BE PLACED 5 CM FROM THE SIDE WALL</p>									

COLONNE PER FORNO H 241

P 59,7

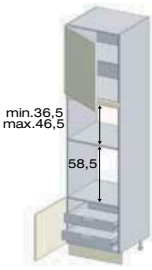
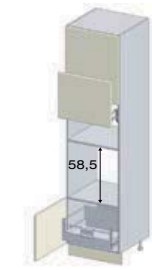
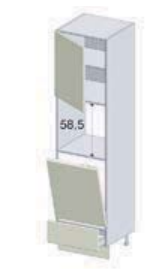



OVEN COLUMNS H 241

	COD.	MELA-MINICO	POLIMERICICO		LACCATO			GLAKS	
		KG6	OPACO KG7	LUCIDO KG7	A KG8	B KG8	PELTRO KG8	KG3	
 <p>*colonna per forno e micro apertura push-pull 1 anta superiore H 72 1 anta inferiore H 48 (cerniere 180°) 2 cassetti interni vano micro da H 36,5 a 46,5</p> <p>*oven and microwave column push-pull opening 1 upper door H 72 1 lower door H 48 (180° hinges) 2 internal drawers microwave compartment H 36,5 to 46,5</p>	L 60	G6561611/2	476	503	527	524	575	656	702
 <p>*colonna per forno 1 anta superiore H 72 1 anta H 48 sollevamento verticale 1 anta inferiore H 48 (cerniere 180°) 1 cestone interno</p> <p>N.B.: in base alla composizione è obbligatorio inserire nella colonna con anta sollevamento verticale, gola tipo "D" per permettere l'apertura della stessa</p> <p>*oven column 1 upper door H 72 1 door H 48 vertical opening 1 lower door H 48 (180° hinges) 1 internal deep drawer</p> <p>Note: based on the composition, a type "D" finger rail must be fitted to the column with vertical opening door to allow it to open</p>	L 60	G6564601/2	639	652	680	678	736	826	903
 <p>colonna per forno e lavastoviglie Rex TTC 1003 1 anta superiore H 72 anta lavastoviglie H 72 cassetto H 24</p> <p>N.B.: in base alla composizione è obbligatorio inserire nella colonna con lavastoviglie, gola tipo "D" per permettere l'apertura della stessa</p> <p>column for oven and REX TTC 1003 dishwasher 1 upper door H 72 dishwasher door H 72 drawer H 24</p> <p>Note: based on the composition, a type "D" finger rail must be fitted to the column with dishwasher to allow it to open</p>	L 60	G6885601/2	488	458	485	488	545	628	669
 <p>profilo in acciaio a "L" per rifinire il ripiano del forno e microonde L-shaped steel finishing profile for oven shelf and microwave</p> 	L 60	08660100	9	9	9	9	9	9	9
<p>NELLE COLONNE PER L'APERTURA DELLE ANTE E' OBBLIGATORIO L'INSERIMENTO DELLE GOLE VERTICALI</p> <p>*LE COLONNE CON CASSETTI E CESTONI INTERNI VANNO SEMPRE POSIZIONATE A 5 CM DALLA PARETE LATERALE</p> <p>VERTICAL FINGER RAILS MUST BE FITTED TO COLUMNS WITH OPENING DOORS</p> <p>*COLUMNS WITH INTERNAL DRAWERS AND DEEP DRAWERS SHOULD ALWAYS BE PLACED 5 CM FROM THE SIDE WALL</p>									

COLONNE PER FORNO H 145 - 217 - 241

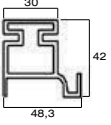
P 59,7

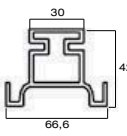

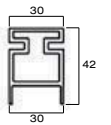
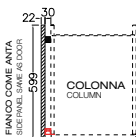

OVEN COLUMNS H 145 - 217 - 241

	COD.	MELAMINICO	POLIMERICO		LACCATO			GLAKS	
		KG6	OPACO KG7	LUCIDO KG7	A KG8	B KG8	PELTRO KG8	KG3	
mezza gola verticale tipo "C" finger rail type "C"									
  <p>Sezione gola tipo "C" Type "C" finger rail section</p>	gola finger rail								
	H 132	G950330	73	73	73	73	73	73	
	H 204	G950350	108	108	108	108	108	108	
	H 228	G950370	116	116	116	116	116	116	
gola verticale intermedia tipo "D" vertical intermediate finger rail type "D"									
  <p>Sezione gola tipo "D" Type "D" finger rail section</p>	gola finger rail								
	H 132	G950430	73	73	73	73	73	73	
	H 204	G950450	108	108	108	108	108	108	
	H 228	G950470	116	116	116	116	116	116	
gola verticale laterale tipo "E" vertical lateral finger rail type "E"									
   <p>Sezione gola tipo "E" Type "E" finger rail section</p>	gola finger rail								
	H 132	G950530	73	73	73	73	73	73	
	H 204	G950550	108	108	108	108	108	108	
	H 228	G950570	116	116	116	116	116	116	
gola con fianco come anta montato finger rail mounted on side panel same as door									
	H 132	G950539	143	226	264	203	247	316	328
	H 204	G950559	206	333	391	310	379	479	513
	H 228	G950579	226	360	425	342	387	535	533

COLONNE PER FRIGO H 145 - 217

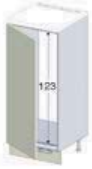
P 59,7

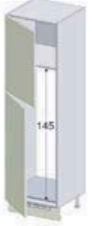
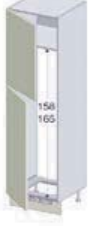
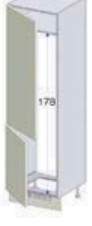

FRIDGE COLUMNS H 145 - 217

Le colonne non sono comprensive di top The columns do not include the tops		COD.	MELA-MINICO	POLIMERICO		LACCATO			GLAKS
			KG6	OPACO KG7	LUCIDO KG7	A KG8	B KG8	PELTRO KG8	KG3
 <p>colonna H 145 per frigo 215 monoporta column H 145 for single-door fridge 215</p>	L 60	G6452151/2	264	299	320	329	375	449	462
		G6462151/2	354	397	431	451	524	642	667
 <p>colonna H 217 per frigo 215 monoporta 1 anta superiore H 72 1 anta inferiore H 132 column H 217 for 215 single-door fridge 1 upper door H 72 lower door H 132</p>	L 60	G6462151/2	354	397	431	451	524	642	667
		G6462311/2	354	397	431	451	524	642	667
 <p>colonna H217 per frigo-freezer 230 - 260 1 anta superiore H 84 1 anta inferiore H 120 column H 217 for 230 - 260 fridge-freezer 1 upper door H 84 1 lower door H 120</p>	L 60	G6462311/2	354	397	431	451	524	642	667
		G6462811/2	354	397	431	451	524	642	667
 <p>colonna H 217 per frigo-freezer 280 1 anta superiore H 84 1 anta inferiore H 120 column H 217 for 280 fridge-freezer 1 upper door H 84 1 lower door H 120</p>	L 60								
		Indesit Ariston L 60 vano H 165 W 60 compartment H 165	G6462811/2	354	397	431	451	524	642
 <p>colonna H 217 per frigo-freezer 280 1 anta superiore H 84 1 anta inferiore H 120 column H 217 for 280 fridge-freezer 1 upper door H 84 1 lower door H 120</p>	L 60								
		Candy e Rex L 60 vano H 158 W 60 compartment H 158	G6462861/2	354	397	431	451	524	642
 <p>colonna H 217 per frigo-congelatore 315 2 ante anta superiore H 132 anta inferiore H 72 column H 217 for 315 fridge-freezer 2 doors upper door H 132 lower door H 72</p>	L 60	G6463151/2	354	397	431	451	524	642	667
<p>NELLE COLONNE PER L'APERTURA DELLE ANTE E' OBBLIGATORIO L'INSERIMENTO DELLE GOLE VERTICALI VERTICAL FINGER RAILS MUST BE FITTED TO COLUMNS WITH OPENING DOORS</p>									

COLONNE PER FRIGO H 217

P 59,7

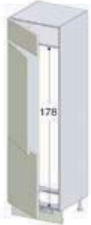

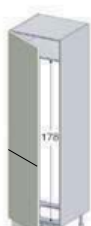
FRIDGE COLUMNS H 217

	COD.	MELA-MINICO	POLIMERICO		LACCATO			GLAKS	
		KG6	OPACO KG7	LUCIDO KG7	A KG8	B KG8	PELTRO KG8	KG3	
 <p>colonna H 217 per frigo-congelatore 315 3 ante anta superiore H 24 anta centrale H 108 anta inferiore H 72 column H 217 for 315 fridge-freezer 3 doors upper door H 24 central door H 108 lower door H 72</p>	L 60	G6463161/2	354	397	431	451	524	642	667
 <p>colonna H 217 per frigo-congelatore 330 1 anta superiore H 132 1 anta inferiore H 72 column H 217 for 330 fridge-freezer 1 upper door H 132 1 lower door H 72</p>	L 60	G6463301/2	354	397	431	451	524	642	667
 <p>colonna H 217 per frigo-freezer 300 monoporta 1 anta H 204 (anta unita 132+72 nelle finiture legno per la versione polimerico) column H 217 for 300 single-door fridge-freezer 1 door H 204 (joint doors 132+72 for wooden finishes of polymeric version)</p>	L 60	G6463001/2	354	397	431	451	524	642	667
<p>NELLE COLONNE PER L'APERTURA DELLE ANTE E' OBBLIGATORIO L'INSERIMENTO DELLE GOLE VERTICALI VERTICAL FINGER RAILS MUST BE FITTED TO COLUMNS WITH OPENING DOORS</p>									

COLONNE PER FRIGO H 241

FRIDGE COLUMNS H 241

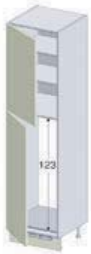
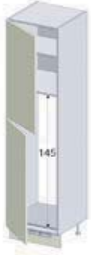
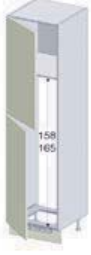
P 59,7

	COD.	MELA-MINICO	POLIMERICO		LACCATO			GLAKS
		KG6	OPACO KG7	LUCIDO KG7	A KG8	B KG8	PELTRO KG8	KG3
 <p>colonna H 241 per frigo 215 monoporta 1 anta superiore H 96 1 anta inferiore H 132 column H 241 for 215 single-door fridge 1 upper door H 96 1 lower door H 132</p>								
	L 60 G6472151/2	376	427	464	489	572	701	739
 <p>colonna H 241 per frigo-freezer 230 - 260 1 anta superiore H 108 1 anta inferiore H 120 column H 241 for 230 - 260 fridge-freezer 1 upper door H 108 1 lower door H 120</p>								
	L 60 G6472311/2	376	427	464	489	572	701	739
 <p>colonna H 241 per frigo-freezer 280 1 anta superiore H 108 1 anta inferiore H 120 column H 241 for 280 fridge-freezer 1 upper door H 108 1 lower door H 120</p> <p>Indesit Ariston</p> <p>L 60 vano H 165 W 60 compartment H 165</p> <p>Candy e Rex</p> <p>L 60 vano H 158 W 60 compartment H 158</p>								
	G6472811/2	376	427	464	489	572	701	739
	G6472861/2	376	427	464	489	572	701	739
 <p>colonna H 241 per frigo-congelatore 315 2 ante 1 anta superiore H 156 (anta unita 132+24 nelle finiture legno per la versione polimerico) 1 anta inferiore H 72 column H 241 for 315 fridge-freezer 2 doors 1 upper door H 156 (joint doors 132+24 for wooden finishes of polymeric version) 1 lower door H 72</p>								
	L 60 G6473151/2	376	427	464	489	572	701	739
<p>NELLE COLONNE PER L'APERTURA DELLE ANTE E' OBBLIGATORIO L'INSERIMENTO DELLE GOLE VERTICALI VERTICAL FINGER RAILS MUST BE FITTED TO COLUMNS WITH OPENING DOORS</p>								

COLONNE PER FRIGO H 241

P 59,7



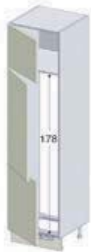
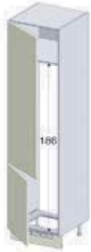
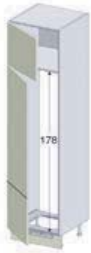

FRIDGE COLUMNS H 241

	COD.	MELA-MINICO	POLIMERICO		LACCATO			GLAKS	
		KG6	OPACO KG7	LUCIDO KG7	A KG8	B KG8	PELTRO KG8	KG3	
 <p>colonna H 241 per frigo-congelatore 315 3 ante 1 anta superiore H 48 1 anta centrale H 108 1 anta inferiore H 72 column H 241 for 315 fridge-freezer 3 doors 1 upper door H 48 1 central door H 108 1 lower door H 72</p>	L 60	G6473161/2	376	427	464	489	572	701	739
	 <p>colonna H 241 per frigo-congelatore 330 2 ante 1 anta superiore H 156 (anta unita 132+24 nelle finiture legno per la versione polimerico) 1 anta inferiore H 72 column H 241 for 330 fridge-freezer 2 doors 1 upper door H 156 (joint doors 132+24 for wooden finishes of polymeric version) 1 lower door H 72</p>	L 60	G6473301/2	376	427	464	489	572	701
 <p>colonna H 241 per frigo-congelatore 300 monoporta 1 anta superiore H 48 1 anta inferiore H 180 (anta unita 108+72 nelle finiture legno per la versione polimerico) column H 241 for 300 single-door fridge-freezer 1 upper door H 48 1 lower door H 180 (joint doors 108+72 for wooden finishes of polymeric version)</p>		L 60	G6473001/2	376	427	464	489	572	701
	<p>NELLE COLONNE PER L'APERTURA DELLE ANTE E' OBBLIGATORIO L'INSERIMENTO DELLE GOLE VERTICALI VERTICAL FINGER RAILS MUST BE FITTED TO COLUMNS WITH OPENING DOORS</p>								

COLONNE PER FRIGO H 145 - 217 - 241

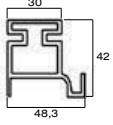
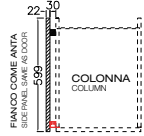
FRIDGE COLUMNS H 145 - 217 - 241

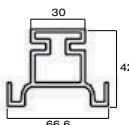
P 59,7

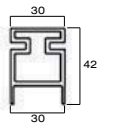
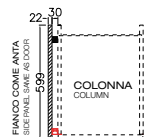
	COD.	MELAMINICO	POLIMERICICO		LACCATO			GLAKS	
		KG6	OPACO KG7	LUCIDO KG7	A KG8	B KG8	PELTRO KG8	KG3	
mezza gola verticale tipo "C" finger rail type "C"   <p>Sezione gola tipo "C" Type "C" finger rail section</p> 	gola finger rail								
	H 132	G950330	73	73	73	73	73	73	
	H 204	G950350	108	108	108	108	108	108	
	H 228	G950370	116	116	116	116	116	116	
	gola con fianco come anta finger rail mounted on side panel same as door								
	H 132	G950339	143	226	264	203	247	316	328
	H 204	G950359	206	333	391	310	379	479	513
	H 228	G950379	226	360	425	342	387	535	533
	gola verticale intermedia tipo "D" vertical intermediate finger rail type "D"   <p>Sezione gola tipo "D" Type "D" finger rail section</p>	gola finger rail							
		H 132	G950430	73	73	73	73	73	73
H 204		G950450	108	108	108	108	108	108	
H 228		G950470	116	116	116	116	116	116	
gola verticale laterale tipo "E" vertical lateral finger rail type "E"   <p>Sezione gola tipo "E" Type "E" finger rail section</p> 	gola finger rail								
	H 132	G950530	73	73	73	73	73	73	
	H 204	G950550	108	108	108	108	108	108	
	H 228	G950570	116	116	116	116	116	116	
	gola con fianco come anta finger rail mounted on side panel same as door								
	H 132	G950539	143	226	264	203	247	316	328
	H 204	G950559	206	333	391	310	379	479	513
H 228	G950579	226	360	425	342	387	535	533	





FIANCHI DI FINITURA

FINISHING SIDE PANELS

	COD.	MELA-MINICO	POLIMERICO		LACCATO			GLAKS
		KG6	OPACO KG7	LUCIDO KG7	A KG8	B KG8	PELTRO KG8	KG3
<p>maggiorazione per fianchi di struttura come anta (cadauno)</p> <p>N.B.: finiture legno venature verticali surcharge for carcass sides same finish as door (each)</p> <p>Note: wooden finishes vertical grains</p>								
	PENSILE							
	WALL UNIT							
	36x31	+24	+20	+24	-	-	-	+67
	48x31	+26	+23	+28	-	-	-	+75
	60x31	+29	+26	+31	-	-	-	+80
	72x31	+34	+29	+36	-	-	-	+88
	96x31	+40	+35	+44	-	-	-	+99
	120x31	+42	+41	+54	-	-	-	+132
	132x31	+45	+44	+56	-	-	-	+136
	BASE ZOCCOLO H 13							
	BASE UNIT - PLINTH H 13							
	37,5x48	+30	+28	+48	-	-	-	+86
	51x48	+33	+33	+58	-	-	-	+103
	37,5x57,5	+30	+28	+48	-	-	-	+86
	51x57,5	+33	+33	+58	-	-	-	+103
	63x57,5	+36	+38	+64	-	-	-	+118
	75x57,5	+39	+44	+69	-	-	-	+126
	COLONNA ZOCCOLO H 13							
	COLUMN - PLINTH H 13							
	132x31	+45	+44	+56	-	-	-	+136
	204x31	+55	+72	+90	-	-	-	+214
	228x31	+63	+81	+100	-	-	-	+241
	96x57,5	+44	+52	+77	-	-	-	+165
	132x57,5	+52	+89	+89	-	-	-	+214
	204x57,5	+64	+104	+133	-	-	-	+342
	228x57,5	+67	+115	+145	-	-	-	+355

COPRIFIANCHI LACCATI

LACQUERED SIDE PANELS

	COD.	MELA-MINICO	POLIMERICO		LACCATO			GLAKS	
		KG6	OPACO KG7	LUCIDO KG7	A KG8	B KG8	PELTRO KG8	KG3	
<p>Coprifianco LACCATO sp.1 mm per rifinire i fianchi a vista LACQUERED side panel th. 1 mm for visible sides finishing</p> 									
	PENSILE WALL UNIT								
	36x31	T98340	—	—	—	47	47	59	—
	48x31	T98345	—	—	—	48	48	61	—
	60x31	T98350	—	—	—	50	50	63	—
	72x31	T98355	—	—	—	52	52	66	—
	96x31	T98360	—	—	—	65	65	85	—
	120x31	T98365	—	—	—	71	71	104	—
132x31	T98367	—	—	—	98	98	113	—	
<p>coprifianco per base laccato colore come anta per rifinire i fianchi a vista scasso superiore per gola lacquered side panel for base unit same finish as doors for visible sides finishing upper cut-out for finger rail</p> 									
	tipo "A" 1 gola type "A" 1 finger rail								
	H 37,5x57,5	T984101/2	—	—	—	62	62	93	—
	H 51x57,5	T984151/2	—	—	—	78	78	110	—
	H 63x57,5	T984201/2	—	—	—	82	82	118	—
H 75x57,5	T984251/2	—	—	—	87	87	128	—	
<p>coprifianco per base laccato colore come anta per rifinire i fianchi a vista scasso superiore ed intermedio per gola lacquered side panel for base unit same finish as doors for visible sides finishing upper and intermediate cut-out for finger rail</p> 									
	tipo "B" 2 gole type "B" 2 finger rails								
	H 63x57,5	T984231/2	—	—	—	82	82	118	—
H 75x57,5	T984271/2	—	—	—	87	87	128	—	
<p>coprifianco per base laccato colore come anta per rifinire i fianchi a vista scasso intermedio per gola lacquered side panel for base unit same finish as doors for visible sides finishing intermediate cut-out for finger rail</p> 									
	tipo "C" 1 gola type "C" 1 finger rail								
H 55x57,5	T984171/2	—	—	—	82	82	110	—	

ANTE DI FINITURA LATERALI

LATERAL FINISHING DOORS

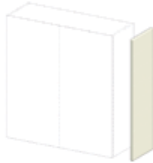
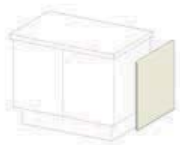

* Per il codice sostituire le XXX con il codice della versione corrispondente
 * Replace XXX with the concerning code version

	*COD.	MELA-MINICO	POLIMERICO		LACCATO			GLAKS
		KG6	OPACO KG7	LUCIDO KG7	A KG8	B KG8	PELTRO KG8	KG3
<p>ante di finitura laterali sp. 2 N.B.: finiture legno venature verticali lateral finishing doors th. 2 Note: wooden finishes vertical grains</p> 								
PENSILE								
WALL UNIT								
H 36 - 35,7x33,2	1XXX4045	44	32	36	36	45	59	82
H 48 - 47,7x33,2	1XXX4046	44	37	42	39	48	62	102
H 60 - 59,7x33,2	1XXX4047	44	42	48	45	57	74	109
H 72 - 71,7x33,2	1XXX405	44	46	54	51	66	87	123
H 96 - 95,7x33,2	1XXX406	50	56	65	65	84	112	131
H 120 - 119,7x33,2	1XXX407	64	71	84	86	112	150	171
H 132 - 131,7x33,2	1XXX408	64	71	84	86	112	150	206
<p>ante di finitura laterali sp. 2 - ZOCCOLO H 13 senza gola N.B.: finiture legno venature verticali lateral finishing doors th. 2 - PLINTH H 13 without finger rail Note: wooden finishes vertical grains</p> 								
BASE ZOCCOLO H 13								
BASE UNIT - PLINTH H 13								
H 50,5 - 37,2x59,6	1XXX3952	41	45	52	50	64	82	104
H 64 - 50,7x59,6	1XXX3963	46	54	63	63	81	107	124
H 76 - 62,7x59,6	1XXX3983	52	62	73	76	103	130	164
H 88 - 74,7x59,6	1XXX4003	55	70	82	90	119	152	194
ISOLA ZOCCOLO H 13								
ISLAND - PLINTH H 13								
H 76 - 62,7x61,7	1XXX4023	58	64	74	78	102	133	164
H 88 - 74,7x61,7	1XXX4033	62	72	85	90	118	157	194
COLONNA ZOCCOLO H 13								
COLUMN - PLINTH H 13								
H 109 - 95,7x59,6	1XXX409	58	110	139	98	130	180	189
H 145 - 131,7x59,6	1XXX410	70	153	191	130	174	243	255
H 217 - 203,7x59,6	1XXX411	98	225	283	202	271	371	405
H 241 - 227,7x59,6	1XXX412	110	244	309	226	332	419	417

ANTE DI FINITURA POSTERIORI

REAR FINISHING DOORS

* Per il codice sostituire le XXX con il codice della versione corrispondente
 * Replace XXX with the concerning code version

	*COD.	MELA-MINICO	POLIMERICO		LACCATO			GLAKS
		KG6	OPACO KG7	LUCIDO KG7	A KG8	B KG8	PELTRO KG8	KG3
<p>ante di finitura posteriori sp.2 senza gola ZOCCOLO H 13 rear finishing doors th. 2 without finger rail PLINTH H 13</p> 								
<p>BASE ZOCCOLO H 13 BASE UNIT - PLINTH H 13</p>								
L 45 - 62,7x44,6	1XXX4243	54	61	70	71	88	110	136
L 60 - 62,7x59,6	1XXX4263	61	72	83	76	103	130	158
L 90 - 62,7x89,6	1XXX4283	75	94	109	117	151	199	212
L 30 - 74,7x29,6	1XXX4303	53	55	62	61	75	91	117
L 40 - 74,7x39,6	1XXX4323	60	63	72	73	92	115	139
L 45 - 74,7x44,6	1XXX4343	62	68	77	79	100	127	150
L 60 - 74,7x59,6	1XXX4363	71	80	93	100	129	162	177
L 90 - 74,7x89,6	1XXX4403	94	98	106	137	177	235	243
<p>BASE ANGOLO ZOCCOLO H 13 CORNER BASE UNIT - PLINTH H 13</p>								
L 65 - 74,7x64,6	1XXX4383	70	85	98	103	133	173	204
<p>ante di finitura posteriori sp.2 per basi uso penisola-isola con gola ZOCCOLO H 13 rear finishing doors th. 2 for base units used as peninsula- island with finger rail PLINTH H 13</p> 								
<p>BASE ZOCCOLO H 13 BASE UNIT - PLINTH H 13</p>								
L 45 - 59,7x44,6	1XXX424	58	69	77	75	91	115	136
L 60 - 59,7x59,6	1XXX426	69	82	92	94	115	146	159
L 90 - 59,7x89,6	1XXX428	84	109	124	130	163	208	220
L 30 - 71,7x29,6	1XXX430	53	60	66	63	76	95	118
L 40 - 71,7x39,6	1XXX432	60	70	78	77	94	119	141
L 45 - 71,7x44,6	1XXX434	63	75	86	83	102	131	152
L 60 - 71,7x59,6	1XXX436	73	90	102	103	112	157	179
L 90 - 71,7x89,6	1XXX440	96	124	141	148	186	245	253
<p>BASE ANGOLO ZOCCOLO H 13 CORNER BASE UNIT - PLINTH H 13</p>								
L 65 - 71,7x64,6	1XXX438	77	95	108	114	142	180	206





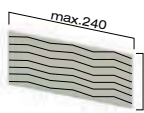
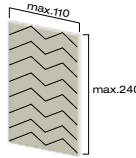
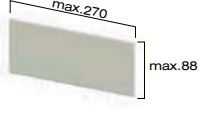
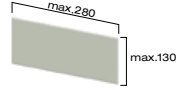













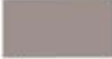

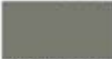



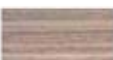









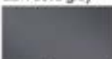

PANNELLI DI FINITURA

FINISHING PANELS

	COD.	MELAMINICO	POLIMERICICO		LACCATO			GLAKS
		KG6	OPACO KG7	LUCIDO KG7	A KG8	B KG8	PELTRO KG8	KG3
<p>pannello di finitura come anta melaminico con venatura verticale 4 lati squadri e bordati N.B.: quantità minima fatturabile 1 mq finishing panel same as melamine door with vertical grain 4 sides squared and rimmed Note: minimum invoiceable quantity 1 m²</p> 								
sp.2 al mq th.2 per m ²	094505	140	—	—	—	—	—	—
<p>pannello di finitura come anta polimerico con venatura orizzontale (escluso rovere cenere) interno colore bianco N.B.: quantità minima fatturabile 0,5 mq polymeric finishing panel same as polymeric door with horizontal grain (except ash oak) interior white Note: minimum invoiceable quantity 0,5 m²</p> 								
sp.2 al mq th.2 per m ²	0945645	—	323	385	—	—	—	—
<p>pannello di finitura polimerico con venatura orizzontale rovere cenere interno colore bianco N.B.: quantità minima fatturabile 0,5 mq polymeric finishing panel with horizontal grain for ash oak door interior white Note: minimum invoiceable quantity 0,5 m²</p> 								
sp.2 al mq th.2 per m ²	0945646	—	323	—	—	—	—	—
<p>pannello di finitura laccato come anta N.B.: quantità minima fatturabile 0,5 mq lacquered finishing panel same as door Note: minimum invoiceable quantity 0,5 m²</p> 								
sp.2 al mq th.2 per m ²	094531	—	—	—	231	231	423	—
<p>pannello di finitura come anta glasks N.B.: quantità minima fatturabile 0,5 mq finishing panel same as glasks door Note: minimum invoiceable quantity 0,5 m²</p> 								
sp.2 al mq th.2 per m ²	094590	—	—	—	—	—	—	357

MENSOLE

SHELVES

	COD.	€		COD.	€
<p>mensola sp. 3,8 in laminato L max cm 400 laminate shelf Th. 3,8 Max. lenght 400 cm</p>  <div style="display: flex; justify-content: space-around; margin-top: 20px;"> <div style="text-align: center;">  bianco (opz.001) white </div> <div style="text-align: center;">  perla d'oriente (opz.940) oriental pearl </div> <div style="text-align: center;">  devalè finitura grafis (opz.796) devalè with grafis finish </div> </div> <div style="display: flex; justify-content: space-around; margin-top: 20px;"> <div style="text-align: center;">  visone (opz.948M) mink </div> <div style="text-align: center;">  rovere cenere (opz.261) oak ash </div> <div style="text-align: center;">  larice moro (opz.218) dark larch </div> </div> <p style="text-align: right; margin-top: 20px;">prezzi al ml prices per lm</p> <p style="text-align: right;">P 31 091523 65</p> <p style="text-align: right;">P 61 091560 84</p>			<p>mensola sp. 3,8 in polimerico finitura come anta L max cm 250 polymeric shelf Th. 3,8, same finish as door Max. lenght 250 cm</p>  <p>FINITURE OPACHE MATT FINISHES</p> <div style="display: grid; grid-template-columns: repeat(3, 1fr); gap: 10px;"> <div style="text-align: center;">  bianco assoluto (opz.740P) absolute white </div> <div style="text-align: center;">  tortora scuro (opz.8981) dark dove grey </div> <div style="text-align: center;">  kaschmir (opz.7713) kaschmir </div> <div style="text-align: center;">  grigio seta (opz.9605) silk grey </div> <div style="text-align: center;">  verde lichene (opz.8441) lichen green </div> <div style="text-align: center;">  blu petrolio (opz.8325) petroleum blue </div> <div style="text-align: center;">  grafite (opz.9619) graphite </div> <div style="text-align: center;">  grigio polvere (opz.9617) dust grey </div> <div style="text-align: center;">  melanzana (opz.270P) aubergine </div> <div style="text-align: center;">  noce chiaro (opz.238P) light walnut </div> <div style="text-align: center;">  noce grigio (opz.239P) grey walnut </div> <div style="text-align: center;">  rovere cenere (opz.260P) ash oak </div> <div style="text-align: center;">  larice bianco (opz.295P) white larch </div> <div style="text-align: center;">  olmo cotto (opz.5072) burnt elm </div> <div style="text-align: center;">  tranchè rovere champagne (opz.5273) tranchè champagne oak </div> </div> <div style="display: flex; justify-content: space-around; margin-top: 20px;"> <div style="text-align: center;">  tranchè rovere visone (opz.5275) tranchè mink oak </div> <div style="text-align: center;"> <p>NEW</p>  frassino white (opz.2411) white ash </div> <div style="text-align: center;"> <p>NEW</p>  frassino dakar (opz.2412) dakar ash </div> </div> <div style="display: flex; justify-content: space-around; margin-top: 20px;"> <div style="text-align: center;"> <p>NEW</p>  frassino stone grey (opz.2413) stone grey ash </div> <div style="text-align: center;"> <p>NEW</p>  rovere naturale (opz.5344) natural oak </div> </div> <p>FINITURE LUCIDE GLOSSY FINISHES</p> <div style="display: grid; grid-template-columns: repeat(3, 1fr); gap: 10px;"> <div style="text-align: center;">  bianco assoluto (opz.741P) absolute white </div> <div style="text-align: center;">  tortora scuro (opz.8982) dark dove grey </div> <div style="text-align: center;">  beige (opz.7712) beige </div> <div style="text-align: center;">  grigio vapore (opz.9606) steam grey </div> <div style="text-align: center;">  antracite (opz.9602) anthracite </div> <div style="text-align: center;">  senape (opz.8224) mustard </div> </div> <p style="text-align: right; margin-top: 20px;">FINITURE OPACHE MATT FINISHES prezzi al ml prices per lm</p> <p style="text-align: right;">P 31 091770I 180</p> <p style="text-align: right;">P 61 091775I 238</p> <p style="text-align: right; margin-top: 20px;">FINITURE LUCIDE GLOSSY FINISHES prezzi al ml prices per lm</p> <p style="text-align: right;">P 31 091770I 192</p> <p style="text-align: right;">P 61 091775I 264</p>		
<p>mensola sp. 3,8 in melaminico finitura come anta, L max cm 400 melamine shelf Th. 3,8 same finish as door Max. lenght 400 cm</p>  <div style="display: flex; justify-content: space-around; margin-top: 20px;"> <div style="text-align: center;">  rovere bianco spazzolato (opz.5311) brushed white oak </div> <div style="text-align: center;">  rovere cipria spazzolato (opz.5312) brushed powder oak </div> <div style="text-align: center;">  abete nordico bianco (opz.4406) white nordic fir </div> </div> <div style="display: flex; justify-content: space-around; margin-top: 20px;"> <div style="text-align: center;">  abete nordico terra (opz.4407) earth nordic fir </div> <div style="text-align: center;">  rovere naturale vintage (opz.5310) vintage natural oak </div> </div> <p style="text-align: right; margin-top: 20px;">prezzi al ml prices per lm</p> <p style="text-align: right;">P 31 091523 76</p> <p style="text-align: right;">P 61 091560 104</p>					

MENSOLE

SHELVES

	COD.	€																															
<p>mensola sp. 3,8 in polimerico, finitura come elementi a giorno L max cm 400 polymeric shelf Th. 3.8, max. same finish as open units length 400 cm</p>  <div style="display: flex; justify-content: space-around; margin-top: 20px;"> <div style="text-align: center;">  bruno antilope (opz.9451) antelope brown </div> <div style="text-align: center;">  acquamarina (opz.8323) aquamarine </div> <div style="text-align: center;">  giallo ambra (opz.8225) amber yellow </div> </div> <div style="display: flex; justify-content: space-around; margin-top: 20px;"> <div style="text-align: center;">  rosa quarzo (opz.8171) quartz pink </div> <div style="text-align: center;">  rosso corallo (opz.8131) coral red </div> <div style="text-align: center;">  salvia (opz.8443) sage </div> </div> <div style="margin-top: 20px;">  vulcano (opz.9615) volcano </div>			<p>finiture laccate opache testurizzate soft e laccate lucide dirette soft textured matt lacquered finishes and direct glossy lacquered finishes:</p> <table border="1" style="width: 100%; text-align: center;"> <tr> <td>bianco assoluto absolute white</td> <td>prugna plum</td> <td>avorio ivory</td> <td>cenere ash</td> <td>blu oltremare lagoon blue</td> </tr> <tr> <td>rosso red</td> <td>rubino ruby</td> <td>verde provenza provence green</td> <td>rosa quarzo quartz pink</td> <td>lavanda lavender</td> </tr> <tr> <td>verde lichene green lichen</td> <td>oro vecchio old gold</td> <td>lime lime</td> <td>lilla lilac</td> <td>blu aviazione aviation blue</td> </tr> <tr> <td>grigio argento silver grey</td> <td>titanio titanium</td> <td>caffè coffee</td> <td>grigio perla pearl grey</td> <td>glicine wisteria</td> </tr> <tr> <td>nero assoluto absolute black</td> <td>mandarino mandarin</td> <td>blu laguna lagoon blue</td> <td>cappuccino cappuccino</td> <td>lavagna slate grey</td> </tr> <tr> <td>giallo ambra amber yellow</td> <td>NEW fango mud</td> <td>NEW bianco caldo warm white</td> <td>tortora dove grey</td> <td>visone mink</td> </tr> </table>	bianco assoluto absolute white	prugna plum	avorio ivory	cenere ash	blu oltremare lagoon blue	rosso red	rubino ruby	verde provenza provence green	rosa quarzo quartz pink	lavanda lavender	verde lichene green lichen	oro vecchio old gold	lime lime	lilla lilac	blu aviazione aviation blue	grigio argento silver grey	titanio titanium	caffè coffee	grigio perla pearl grey	glicine wisteria	nero assoluto absolute black	mandarino mandarin	blu laguna lagoon blue	cappuccino cappuccino	lavagna slate grey	giallo ambra amber yellow	NEW fango mud	NEW bianco caldo warm white	tortora dove grey	visone mink
bianco assoluto absolute white	prugna plum	avorio ivory	cenere ash	blu oltremare lagoon blue																													
rosso red	rubino ruby	verde provenza provence green	rosa quarzo quartz pink	lavanda lavender																													
verde lichene green lichen	oro vecchio old gold	lime lime	lilla lilac	blu aviazione aviation blue																													
grigio argento silver grey	titanio titanium	caffè coffee	grigio perla pearl grey	glicine wisteria																													
nero assoluto absolute black	mandarino mandarin	blu laguna lagoon blue	cappuccino cappuccino	lavagna slate grey																													
giallo ambra amber yellow	NEW fango mud	NEW bianco caldo warm white	tortora dove grey	visone mink																													
<p>prezzi al ml prices per lm P 31</p>	091771	82																															
<p>mensola sp. 3,8 laccata come anta, L max cm 300 shelf Th. 3.8 lacquered same as door, max. length 300 cm</p> 			<p>finitura laccata peltro pewter lacquered finish</p> <div style="margin-top: 20px;"> <p>NEW</p>  peltro pewter </div>																														
<p>LACCATA OPACA E LUCIDA prezzi al ml Matt and glossy lacquered prices per lm</p> <p>P 31 091733 139</p> <p>P 61 091736 226</p> <p>LACCATA PELTRO prezzi al ml Pewter lacquered prices per lm</p> <p>P 31 091733 213</p> <p>P 61 091736 311</p>			<p> consegna: minimo 5 settimane dalla conferma dell'ordine delivery: minimum 5 weeks from order confirmation</p> <p>colore a campione Ral (opz.998) RAL sample colours</p>																														

LIVING

Spazi coordinati per avere un solo ambiente per cucinare, ricevere gli amici, pranzare e rilassarsi è una soluzione al desiderio di vivere la casa più liberamente, secondo stili di vita contemporanei, integrando cucina e living all'insegna di un nuovo linguaggio progettuale.

Coordinated spaces that create a single environment in which to cook, receive friends and relax is a solution that allows you to experience the home more freely.





In line with contemporary lifestyles, this solution integrates the kitchen and living area to create a new design language



PENSILI LIVING

P 33,2









LIVING AREA WALL UNITS

Per la modulistica completa dei pensili P 33,2 consultare la sezione "Pensili" For complete modularity of wall units D 33,2 see "Wall units" section	COD.	MELAMINICO	POLIMERICO		LACCATO			GLAKS	
		K26-KG6	OPACO	LUCIDO	A	B	PELTRO	K30-KG3	
			K27-KG7	K27-KG7	K28-KG8	K28-KG8	K28-KG8		
 <p>pensile H 36 P 33,2 apertura a vasistas con push-pull (opz.996) wall unit H 36 D 33,2 flap door with push-pull opening (code 996)</p>	L 60	E/G2106600	149	156	162	160	172	189	207
	L 90	E/G2106900	232	242	250	250	268	294	311
 <p>pensile H 48 P 33,2 apertura a vasistas con push-pull (opz.996) wall unit H 48 D 33,2 flap door with push-pull opening (code 996)</p>	L 60	E/G2123600	233	242	250	249	265	289	310
	L 90	E/G2123900	257	272	283	285	309	345	363
 <p>mensola in appoggio per pensile in melaminico finitura come anta support shelf for wall unit melamine same finish as door</p> <p>P 33,2 sp.2,2 al ml D 33,2 th.2,2 per lm</p> <p>melaminico L max 275 melamine</p> <p>polimerico L max 240 polymeric</p> <p>laccato L max 270 lacquered</p> <p>glaks L max 280</p>		TLE203	87	-	-	-	-	-	-
		TLM203	-	119	136	-	-	-	-
		TLC203	-	-	-	122	122	148	-
		TLA203	-	-	-	-	-	-	122
 <p>maggiorazione per fianchi di struttura come anta (cadauno) surcharge for carcass sides same finish as door (each)</p>	PENSILI WALL UNITS								
	36X31		+24	+20	+24	-	-	-	+67
	48X31		+26	+23	+28	-	-	-	+75
 <p>Coprifianco LACCATO sp.1 mm per rifinire i fianchi a vista LACQUERED side panel th. 1 mm for visible sides finishing</p>	PENSILI WALL UNITS								
	36X31	T98340	-	-	-	47	47	59	-
	48X31	T98345	-	-	-	48	48	61	-

BASI LIVING con piedi cromati H 2 KYRA CON MANIGLIA

H 38 - 50 P 50,2

LIVING AREA BASE UNITS with chromed feet H 2 KYRA WITH HANDLE









Le basi non sono comprensive di top - N.B.: cerniere ammortizzate di serie The base units do not include the tops - Note: standard blumotion hinges		COD.	MELAMINICO	POLIMERICO		LACCATO			GLAKS	
			K26	OPACO K27	LUCIDO K27	A K28	B K28	PELTRO K28	K30	
 <p>base H 38 1 anta H 36 base unit H 38 1 door H 36</p>	L 45	EBL21451/2	139	143	148	145	154	167	191	
	L 60	EBL21601/2	151	158	164	162	174	191	209	
	L 90	EBL21900	214	223	233	227	245	270	318	
 <p>base H 38 2 ante H 36 base unit H 38 2 doors H 36</p>	L 120	EBL22200	253	265	278	273	297	332	369	
	L 90	EBL25900	227	236	245	244	262	289	305	
 <p>base H 38 1 cestone H 36 base unit H 38 1 deep drawer H 36</p>	L 45	EBL25450	174	178	183	180	189	202	225	
	L 60	EBL25600	188	194	201	198	210	228	246	
	L 90	EBL25900	227	236	245	244	262	289	305	
 <p>base H 38 2 cassetti H 18 base unit H 38 2 drawers H 18</p>	L 45	EBL23450	223	224	230	231	244	283	297	
	L 60	EBL23600	258	257	264	262	277	309	335	
	L 90	EBL23900	289	293	303	304	325	338	393	
 <p>base H 50 1 anta H 48 base unit H 50 1 door H 48</p>	L 45	EBL31451/2	144	150	156	153	165	183	209	
	L 60	EBL31601/2	157	166	173	172	188	212	233	
 <p>base H 50 2 ante H 48 base unit H 50 2 doors H 48</p>	L 90	EBL31900	224	235	247	242	266	302	354	
	L 120	EBL32200	263	281	297	294	325	374	416	
 <p>base H 50 1 cestone H 48 base unit H 50 1 deep drawer H 48</p>	L 45	EBL35450	179	184	191	188	200	218	244	
	L 60	EBL35600	193	202	210	209	225	249	270	
	L 90	EBL35900	233	248	259	261	285	321	339	
 <p>top living H 2 P 50,2 living worktop H 2 D 50,2</p>										
		P 50,2 sp.2 al ml D 50,2 th.2 per lm melaminico L max 275 melamine	TLE205	96	—	—	—	—	—	—
		polimerico L max 240 polymeric	TLM205	—	140	164	—	—	—	—
		laccato L max 270 lacquered	TLC204	—	—	—	178	178	234	—
	glaks L max 280	TLG205	—	—	—	—	—	—	163	

BASI SOSPENSE LIVING con Attaccaglie KYRA CON MANIGLIA

H 36 - 48 P 50,2

HANGING LIVING BASE UNITS with Hangers and Rods for wall mounting KYRA WITH HANDLE

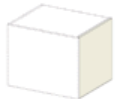



Le basi non sono comprensive di top - N.B.: cerniere ammortizzate di serie
 The base units do not include the tops - Note: standard blumotion hinges

	COD.	MELAMINICO	POLIMERICO		LACCATO			GLAKS	
		K26	OPACO K27	LUCIDO K27	A K28	B K28	PELTRO K28	K30	
 <p>base H 36 1 anta base unit H 36 1 door</p>	L 45	EBL71451/2	127	132	137	133	142	155	179
	L 60	EBL71601/2	137	144	150	148	160	177	195
 <p>base H 36 2 ante base unit H 36 2 doors</p>	L 90	EBL71900	190	200	210	203	221	247	294
	L 120	EBL72200	222	235	247	243	267	301	338
 <p>base H 36 1 cestone base H 36 1 deep drawer</p>	L 45	EBL75450	172	177	182	178	188	200	224
	L 60	EBL75600	186	193	199	197	209	226	244
	L 90	EBL75900	225	235	243	243	261	287	304
 <p>base H 48 1 anta base unit H 48 1 door</p>	L 45	EBL81451/2	141	147	153	150	162	180	206
	L 60	EBL81601/2	154	163	171	169	185	209	230
 <p>base H 48 2 ante base unit H 48 2 doors</p>	L 90	EBL81900	217	228	240	235	259	294	347
	L 120	EBL82200	254	272	287	285	316	365	406
 <p>base H 48 1 cestone base unit H 48 1 deep drawer</p>	L 45	EBL85450	177	183	189	186	198	216	242
	L 60	EBL85600	192	201	209	207	223	247	268
	L 90	EBL85900	231	246	257	259	283	319	338
 <p>maggiorazione per fianchi di struttura come anta (cadauno) surcharge for carcass sides same finish as door (each)</p>	BASI BASE UNITS								
	36x48		+30	+28	+48	—	—	—	+86
	48x48		+33	+33	+58	—	—	—	+103
 <p>fianco living lateral finish panel for living base unit</p>	laccato lacquered								
	P 50,2 sp.2 al ml D 50,2 th.2 per ml	TLC204F	—	—	—	198	198	254	—

BASI LIVING CON ZOCCOLO KYRA CON MANIGLIA

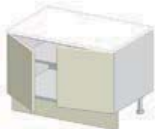
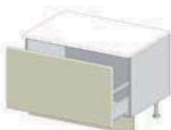

H 51 - 63 P 59,7

LIVING AREA BASE UNITS WITH PLINTH KYRA WITH HANDLE

Le basi non sono comprensive di top - N.B.: cassetti e cestoni ad estrazione totale con blumotion The base units do not include the tops - Note: fully extending drawers and deep drawers with blumotion system		COD.	MELA-MINICO	POLIMERICO		LACCATO			GLAKS
			K26	OPACO K27	LUCIDO K27	A K28	B K28	PELTRO K28	K30
 <p>base H 51 1 anta H 36 base unit H 51 1 door H 36</p>	L 45	E4026451/2	126	131	136	133	142	155	178
	L 60	E4026601/2	141	147	153	151	163	180	199
 <p>base H 51 2 ante H 36 base unit H 51 2 doors H 36</p>	L 90	E4026900	207	216	226	220	238	263	311
	L 120	E4027200	238	251	263	259	283	317	354
 <p>base H 51 1 cestone H 36 base unit H 51 1 deep drawer H 36</p>	L 45	E4204450	158	163	167	164	173	186	210
	L 60	E4204600	174	180	187	184	196	214	232
	L 90	E4204900	218	227	236	235	253	280	296
 <p>base H 51 2 cassetti H 18 base unit H 51 2 drawers H 18</p>	L 45	E4204460	204	206	212	212	225	264	279
	L 60	E4204610	227	226	233	231	246	278	304
	L 90	E4204910	275	278	289	290	311	324	378
 <p>base H 63 1 anta H 48 base unit H 63 1 door H 48</p>	L 45	E4028451/2	132	137	144	141	153	171	197
	L 60	E4028601/2	146	155	163	162	177	202	222
 <p>base H 63 2 ante H 48 base unit H 63 2 doors H 48</p>	L 90	E4028900	217	228	240	235	259	295	347
	L 120	E4029200	248	266	282	279	311	359	401
 <p>base H 63 1 cestone H 48 base unit H 63 1 deep drawer H 48</p>	L 45	E4205450	163	169	175	172	184	202	228
	L 60	E4205600	179	188	196	195	210	235	256
	L 90	E4205900	224	239	250	252	276	312	331

BASI LIVING CON ZOCCOLO KYRA CON MANIGLIA

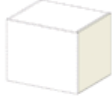







LIVING AREA BASE UNITS WITH PLINTH KYRA WITH HANDLE

	COD.	MELAMINICO	POLIMERICO		LACCATO			GLAKS
		KG6	OPACO KG7	LUCIDO KG7	A KG8	B KG8	PELTRO KG8	KG3
 <p>top living H 2 P 59,7 living worktop H 2 D 59,7</p> <p>P 59,7 sp.2 al ml D 59,7 th.2 per lm</p> <p>melaminico L max 275 melamine</p> <p>polimerico L max 240 polymeric</p> <p>laccato L max 270 lacquered</p> <p>glaks L max 280</p>	TLE206	107	—	—	—	—	—	—
	TLM206	—	158	186	—	—	—	—
	TLC206	—	—	—	188	188	268	—
	TLA206	—	—	—	—	—	—	172
 <p>maggiorazione per fianchi di struttura come anta (cadauno) surcharge for carcass sides same finish as door (each)</p> <p>BASI BASE UNITS</p> <p>36x48</p> <p>48x48</p>								
		+30	+28	+48	—	—	—	+86
		+33	+33	+58	—	—	—	+103
 <p>fianco living lateral finish panel for living base unit</p> <p>laccato lacquered</p> <p>P 59,7 sp.2 al ml D 59,7 th.2 per ml</p>	TLC206F	—	—	—	208	208	288	—

BASI LIVING con piedi cromati H 2 KYRA NECK

H 39,5 - 53 P 50,2

LIVING AREA BASE UNITS with chromed feet H 2



Le basi non sono comprensive di top - N.B.: cerniere ammortizzate di serie The base units do not include the tops - Note: standard blumotion hinges		COD.	MELAMINICO	POLIMERICO		LACCATO			GLAKS	
			KG6	OPACO KG7	LUCIDO KG7	A KG8	B KG8	PELTRO KG8	KG3	
 <p>base H 39,5 1 anta H 34,2 base unit H 39,5 1 door H 34,2</p>	L 45	GBL21451/2	139	144	148	146	155	166	191	
	L 60	GBL21601/2	154	160	166	165	177	192	212	
 <p>base H 39,5 2 ante H 34,2 base unit H 39,5 2 doors H 34,2</p>	L 90	GBL21900	215	224	233	229	247	268	319	
	L 120	GBL22200	254	266	278	276	300	329	371	
 <p>base H 39,5 1 cestone H 34,2 base unit H 39,5 1 deep drawer H 34,2</p>	L 45	GBL25450	174	179	183	181	199	201	226	
	L 60	GBL25600	191	197	203	202	214	228	249	
	L 90	GBL25900	234	243	251	252	270	293	313	
 <p>base H 39,5 2 cassetti H 16,9 base unit H 39,5 2 drawers H 16,9</p>	L 45	GBL23450	217	218	224	225	239	277	292	
	L 60	GBL23600	252	253	260	259	274	306	332	
	L 90	GBL23900	290	293	303	306	327	335	394	
 <p>base H 53 1 anta H 47,7 base unit H 53 1 door H 47,7</p>	L 45	GBL31451/2	145	151	157	154	166	184	210	
	L 60	GBL31601/2	160	169	177	175	191	215	236	
 <p>base H 53 2 ante H 47,7 base unit H 53 2 doors H 47,7</p>	L 90	GBL31900	226	237	249	244	268	303	356	
	L 120	GBL32200	266	284	299	297	328	377	418	
 <p>base H 53 1 cestone H 47,7 base unit H 53 1 deep drawer H 47,7</p>	L 45	GBL35450	180	185	192	189	201	219	245	
	L 60	GBL35600	197	206	214	212	228	252	273	
	L 90	GBL35900	241	256	267	269	293	329	347	
 <p>top living H 2 P 50,2 living worktop H 2 D 50,2</p>										
		P 50,2 sp.2 al ml D 50,2 th.2 per lm melaminico L max 275 melamine	TLE205	96	—	—	—	—	—	—
		polimerico L max 240 polymeric	TLM205	—	140	164	—	—	—	—
		laccato L max 270 lacquered	TLC204	—	—	—	178	178	234	—
	glaks L max 280	TLG205	—	—	—	—	—	—	163	

BASI SOSPENSE LIVING con Attaccaglie KYRA NECK

H 37,5 - 51 P 50,2

HANGING LIVING BASE UNITS with Hangers and Rods for wall mounting







Le basi non sono comprensive di top - N.B.: cerniere ammortizzate di serie
 The base units do not include the tops - **Note:** standard blumotion hinges

	COD.	MELAMINICO	POLIMERICO		LACCATO			GLAKS	
		KG6	OPACO KG7	LUCIDO KG7	A KG8	B KG8	PELTRO KG8	KG3	
 <p>base H 37,5 1 anta base unit H 37,5 1 door</p>	L 45	GBL71451/2	127	132	137	134	143	154	180
	L 60	GBL71601/2	140	146	152	151	163	178	199
 <p>base H 37,5 2 ante base unit H 37,5 2 doors</p>	L 90	GBL71900	191	200	210	205	223	244	296
	L 120	GBL72200	227	239	251	249	273	303	345
 <p>base H 37,5 1 cestone base H 37,5 1 deep drawer</p>	L 45	GBL75450	172	177	182	179	188	199	225
	L 60	GBL75600	189	195	201	200	212	227	248
	L 90	GBL75900	232	241	250	251	269	291	312
 <p>base H 51 1 anta base unit H 51 1 door</p>	L 45	GBL81451/2	142	148	154	151	163	181	207
	L 60	GBL81601/2	157	166	174	173	188	213	233
 <p>base H 51 2 ante base unit H 51 2 doors</p>	L 90	GBL81900	219	230	242	237	261	296	348
	L 120	GBL82200	260	278	294	291	323	371	413
 <p>base H 51 1 cestone base unit H 51 1 deep drawer</p>	L 45	GBL85450	178	184	190	187	198	217	243
	L 60	GBL85600	195	204	212	210	226	251	271
	L 90	GBL85900	239	254	265	267	291	327	346
 <p>maggiorazione per fianchi di struttura come anta (cadauno) surcharge for carcass sides same finish as door (each)</p>	BASI BASE UNITS								
	37,5x48		+30	+28	+48	—	—	—	+86
	51x48		+33	+33	+58	—	—	—	+103
 <p>fianco living lateral finish panel for living base unit</p>	laccato lacquered								
	P 50,2 sp.2 al ml	TLC204F	—	—	—	198	198	254	—
	D 50,2 th.2 per ml								

BASI LIVING CON ZOCCOLO KYRA NECK



H 50,5 - 64 P 59,7

LIVING AREA BASE UNITS WITH PLINTH

Le basi non sono comprensive di top - N.B.: cassetti e cestoni ad estrazione totale con blumotion The base units do not include the tops - Note: fully extending drawers and deep drawers with blumotion system		COD.	MELA-MINICO	POLIMERICO		LACCATO			GLAKS
			KG6	OPACO KG7	LUCIDO KG7	A KG8	B KG8	PELTRO KG8	KG3
 <p>base H 51 1 anta H 36 base unit H 51 1 door H 36</p>	L 45	G4026451/2	131	136	140	138	147	158	184
	L 60	G4026601/2	151	157	163	162	174	188	210
 <p>base H 51 2 ante H 36 base unit H 51 2 doors H 36</p>	L 90	G4026900	205	215	224	219	238	259	310
	L 120	G4027200	239	252	264	261	286	315	357
 <p>base H 51 1 cestone H 36 base unit H 51 1 deep drawer H 36</p>	L 45	G4204450	163	168	172	170	179	190	215
	L 60	G4204600	184	190	196	195	207	222	243
	L 90	G4204900	223	233	241	242	260	283	303
 <p>base H 51 2 cassetti H 18 base unit H 51 2 drawers H 18</p>	L 45	G4204460	215	216	222	224	237	276	290
	L 60	G4204610	243	243	251	250	264	297	323
	L 90	G4204910	299	302	312	314	336	344	403
 <p>base H 63 1 anta H 48 base unit H 63 1 door H 48</p>	L 45	G4028451/2	137	143	149	146	158	176	202
	L 60	G4028601/2	157	166	174	172	188	212	233
 <p>base H 63 2 ante H 48 base unit H 63 2 doors H 48</p>	L 90	G4028900	217	228	240	235	259	294	347
	L 120	G4029200	251	269	285	282	314	362	404
 <p>base H 63 1 cestone H 48 base unit H 63 1 deep drawer H 48</p>	L 45	G4205450	169	175	181	178	190	208	234
	L 60	G4205600	190	199	207	205	221	245	266
	L 90	G4205900	230	245	257	259	282	318	337

BASI LIVING CON ZOCCOLO KYRA NECK

LIVING AREA BASE UNITS WITH PLINTH

	COD.	MELAMINICO	POLIMERICO		LACCATO			GLAKS
		KG6	OPACO KG7	LUCIDO KG7	A KG8	B KG8	PELTRO KG8	KG3
 <p>top living H 2 P 59,7 living worktop H 2 D 59,7</p> <p>P 59,7 sp.2 al ml D 59,7 th.2 per lm</p> <p>melaminico L max 275 melamine</p> <p>polimerico L max 240 polymeric</p> <p>laccato L max 270 lacquered</p> <p>glaks L max 280</p>								
	TLE206	107	—	—	—	—	—	—
	TLM206	—	158	186	—	—	—	—
	TLC206	—	—	—	188	188	268	—
	TLA206	—	—	—	—	—	—	172
 <p>maggiorazione per fianchi di struttura come anta (cadauno) surcharge for carcass sides same finish as door (each)</p> <p>BASI BASE UNITS</p> <p>37,5x57,5</p> <p>51x57,5</p>								
		+30	+28	+48	—	—	—	+86
		+33	+33	+58	—	—	—	+103
 <p>fianco living lateral finish panel for living base unit</p> <p>laccato lacquered</p> <p>P 59,7 sp.2 al ml D 59,7 th.2 per ml</p>								
	TLC206F	—	—	—	208	208	288	—

LIVING KKY-1



ANTE
doors

MELAMINICO
ROVERE BIANCO
SPAZZOLATO
melamine brushed white
oak

LACCATO VERDE
LICHENE LUCIDO
glossy lacquered
lichen green

ELEMENTI A GIORNO
open units

BRUNO ANTILOPE
antelope brown

STRUTTURE
carcasses

BIANCO
white

VISONE
mink

LIVING KKY-1

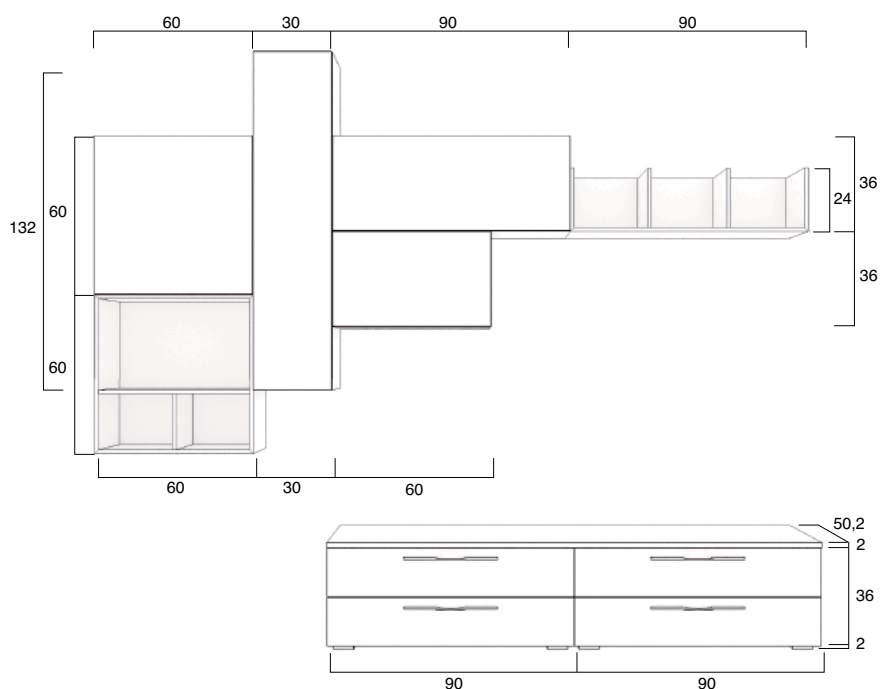

NR. ELEMENTI	DESCRIZIONE	CODICE	€ cad.
1	Pensile L 60 H 60 P 33,2 apertura push-pull	E2060601/2	165
1	Pensile L 30 H 132 P 33,2 apertura push-pull, 2 fianchi come anta	E2141301/2	270
1	Pensile L 90 H 36 P 33,2 anta ribalta tip-on, 1 fianco come anta	E210091T	193
1	Pensile L 60 H 36 P 33,2 apertura vasistas, 1 fianco come anta	E2106600	219
1	Elemento a giorno L 60 H 60 P 31 in polimerico 3 vani	E7700720	252
1	Elemento a giorno L 90 H 24 P 31 in polimerico 3 vani	E7700717	223
2	Base living L 90 H 36 P 50,2, 2 cassetti, 1 fianco come anta	EBL23900	319
1	Top L 180 H 2 P 50,2 in melaminico come anta	al ml TLE205	96
2	Asta appendipensili ml 2	08610501	9
TOTALE			2.151
No. of ELEMENTS	DESCRIPTION	CODE	€ each
1	Wall unit W 60 H 60 D 33,2 push-pull opening	E2060601/2	165
1	Wall unit W 30 H 132 D 33,2 push-pull opening, 2 sides same as door	E2141301/2	270
1	Wall unit W 90 H 36 D 33,2 flap door tip-on opening, 1 side same as door	E210091T	193
1	Wall unit W 60 H 36 D 33,2 flap door opening, 1 side same as door	E2106600	219
1	Polymeric open unit W 60 H 60 D 31 with 3 compartments	E7700720	252
1	Polymeric open unit W 90 H 24 D 31 with 3 compartments	E7700717	223
2	Living base unit W 90 H 36 D 50,2, 2 drawers, 1 side same as door	EBL23900	319
1	Melamine worktop W 180 H 2 D 50,2 same as door	per lm TLE205	96
2	Wall unit fixing strip mt. 2	08610501	9
TOTAL			2.151

LIVING KKY-2



ANTE
doors



ELEMENTI A GIORNO
open units



STRUTTURE
carcasses

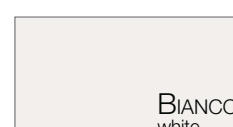

LIVING KKY-2

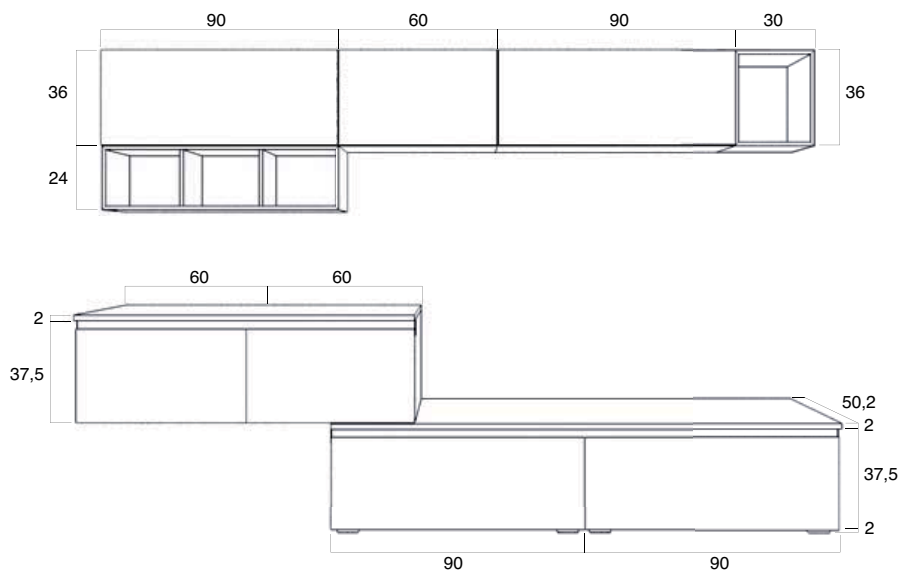

NR. ELEMENTI	DESCRIZIONE	CODICE	€ cad.
1	Pensile L 90 H 36 P 33,2 anta ribalta tip-on, 1 fianco come anta	G210091T	211
1	Pensile L 60 H 36 P 33,2 anta ribalta, apertura con presa sul fondo	G2100600	129
1	Maggiorazione per fondo luminoso a led	Opz.055	163
1	Pensile L 90 H 36 P 33,2 anta ribalta, apertura con presa sul fondo	G2100900	168
1	Maggiorazione per fondo luminoso a led	Opz.055	190
1	Elemento a giorno L 90 H 24 P 31 in polimerico 3 vani	E7700707	209
1	Elemento a giorno L 30 H 36 P 31 in polimerico 1 vano	E7700709	130
2	Base living sospesa L 60 H 37,5 P 50,2, cestone, 1 fianco come anta	GBL75600	223
2	Base living L 90 H 39,5 P 50,2, cestone, 1 fianco come anta	GBL25900	271
1	Top L 120 H 2 P 50,2 in polimerico come anta	al ml TLM205	140
1	Top L 180 H 2 P 50,2 in polimerico come anta	al ml TLM205	140
2	Asta appendipensili ml 2	08610501	9
TOTALE			2.627
No. of ELEMENTS	DESCRIPTION	CODE	€ each
1	Wall unit W 90 H 36 D 33,2 flap door tip-on opening, 1 side same as door	G210091T	211
1	Wall unit W 60 H 36 D 33,2 flap door, grip on bottom opening	G2100600	129
1	Surcharge for led lit bottom	Opz.055	163
1	Wall unit W 90 H 36 D 33,2 flap door, grip on bottom opening	G2100900	168
1	Surcharge for led lit bottom	Opz.055	190
1	Polymeric open unit W 90 H 24 D 31 with 3 compartments	E7700707	209
1	Polymeric open unit W 30 H 36 D 31 with 1 compartment	E7700709	130
2	Suspended living base unit W 60 H 37,5 D 50,2 deep drawer, 1 side same as door	GBL75600	223
2	Living base unit W 90 H 39,5 D 50,2, deep drawer, 1 side same as door	GBL25900	271
1	Polymeric worktop W 120 H 2 D 50,2 same as door	per lm TLM205	140
1	Polymeric worktop W 180 H 2 D 50,2 same as door	per lm TLM205	140
2	Wall unit fixing strip mt. 2	08610501	9
TOTAL			2.627

LIVING KKY-3



ANTE
doors

POLIMERIC
CELESTE ALPACA
LUCIDO
polymeric glossy
alpaca light blue

POLIMERIC
KASCHMIR OPACO
polymeric matt kaschmir

ELEMENTI A GIORNO
open units

BRUNO ANTILOPE
antelope brown

STRUTTURE
carcasses

PERLA D'ORIENTE
oriental pearl

BIANCO
white

LIVING KKY-3

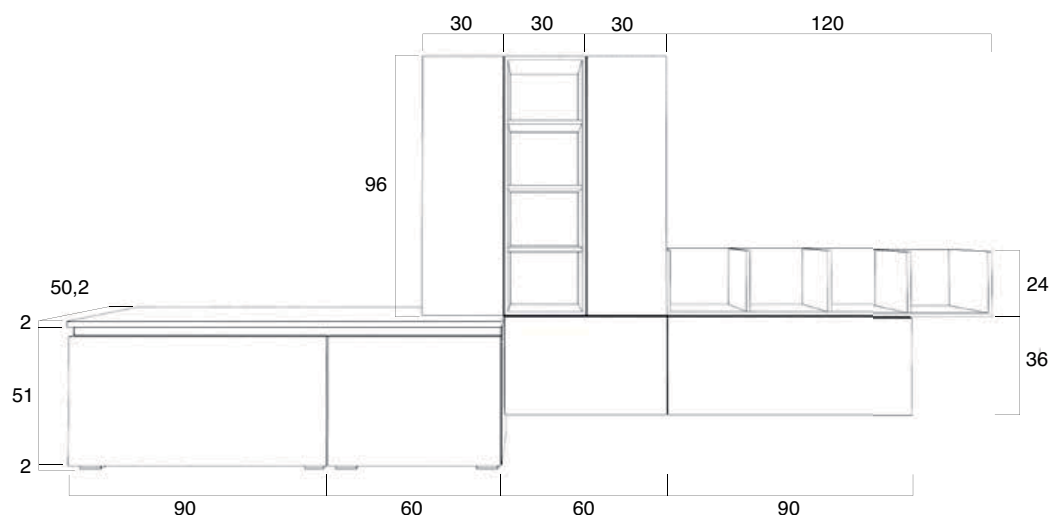

NR. ELEMENTI	DESCRIZIONE	CODICE	€ cad.
1	Base living L 90 H 53 P 50,2, cestone, 1 fianco come anta	GBL35900	315
1	Base living L 60 H 53 P 50,2, cestone, 1 fianco come anta	GBL35600	262
2	Pensile L 30 H 96 P 33,2 apertura push-pull, 1 fianco come anta	G2020301/2	162
1	Elemento a giorno L 30 H 96 P 31 in polimerico 4 vani	E7700735	244
1	Elemento a giorno L 120 H 24 P 31 in polimerico 4 vani	E7700718	266
1	Pensile L 60 H 36 P 33,2 apertura vasistas	G2106600	156
1	Pensile L 90 H 36 P 33,2 apertura vasistas, 1 fianco come anta	G2106900	262
1	Top L 150 H 2 P 50,2 in polimerico come anta	al ml TLM205	140
3	Asta appendipensili ml 2	08610501	9
TOTALE			2.067
No. of ELEMENTS	DESCRIPTION	CODE	€ each
1	Living base unit W 90 H 53 D 50,2, deep drawer, 1 side same as door	GBL35900	315
1	Living base unit W 60 H 53 D 50,2, deep drawer, 1 side same as door	GBL35600	262
2	Wall unit W 30 H 96 D 33,2 push-pull opening, 1 side same as door	G2020301/2	162
1	Polymeric open element W 30 H 96 D 31 with 4 compartments	E7700735	244
1	Polymeric open element W 120 H 24 D 31 with 4 compartments	E7700718	266
1	Wall unit W 60 H 36 D 33,2 flap door opening	G2106600	156
1	Wall unit W 90 H 36 D 33,2 flap door opening, 1 side same as door	G2106900	262
1	Polymeric worktop W 150 H 2 D 50,2 same as door	per lm TLM205	140
3	Wall unit fixing strip mt. 2	08610501	9
TOTAL			2.067

LIVING KKY-4



ANTE
doors

LACCATO
FANGO LUCIDO
glossy lacquered
clay

MELAMINICO
ABETE NORDICO
BIANCO
melamine white nordic fir

ELEMENTI A GIORNO
open units

ROSA QUARZO
quartz pink

STRUTTURE
carcasses

VISIONE
mink

BIANCO
white

LIVING KKY-4



NR. ELEMENTI	DESCRIZIONE	CODICE	€ cad.
2	Base living sospesa L 90 H 36 P 50,2, cestone, 1 fianco come anta	EBL75900	255
3	Pensile L 60 H 60 P 33,2 apertura push-pull, 1 fianco come anta	E2060601/2	196
1	Elemento a giorno L 60 H 60 P 31 in polimerico 3 vani	E7700720	252
1	Elemento a giorno L 90 H 24 P 31 in polimerico 3 vani	E7700707	209
1	Top L 180 H 2 P 50,2 in melaminico come anta	al ml TLE205	96
2	Asta appendipensili ml 2	08610501	9
TOTALE			1.750
No. of ELEMENTS	DESCRIPTION	CODE	€ each
2	Suspended living base unit W 90 H 36 D 50,2, deep drawer, 1 side same as door	EBL75900	255
3	Wall unit W 60 H 60 D 33,2 push-pull opening, 1 side same as door	E2060601/2	196
1	Polymeric open unit W 60 H 60 D 31 with 3 compartments	E7700720	252
1	Polymeric open unit W 90 H 24 D 31 with 3 compartments	E7700707	209
1	Melamine worktop W 180 H 2 D 50,2 same as door	per lm TLE205	96
2	Wall unit fixing strip mt. 2	08610501	9
TOTAL			1.750

LIVING KKY-5



ANTA
door

MELAMINICO
ROVERE BIANCO
SPAZZOLATO
melamine brushed
white oak

ELEMENTI A GIORNO
open units

BRUNO ANTILOPE
antelope brown

STRUTTURA
carcass

BIANCO
white

LIVING KKY-5

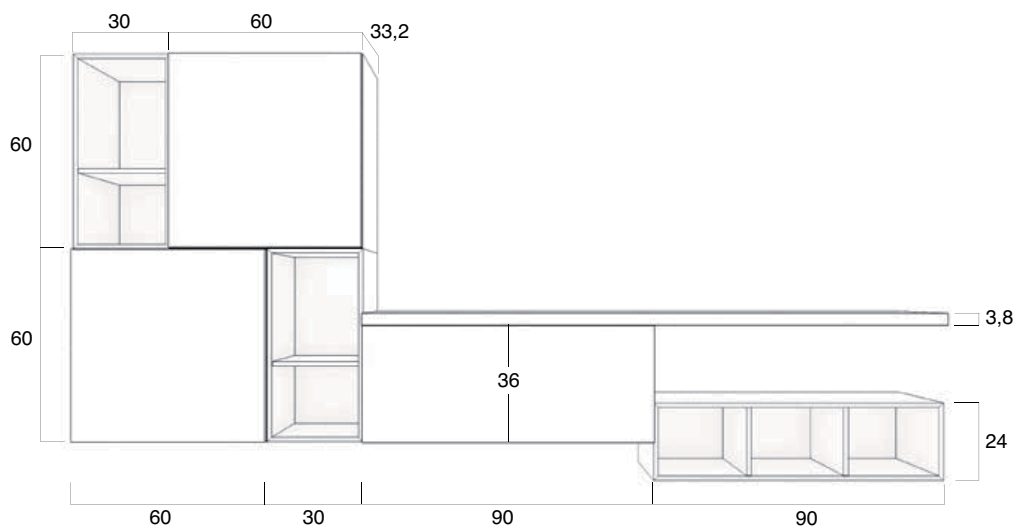

NR. ELEMENTI	DESCRIZIONE	CODICE	€ cad.
2	Pensile L 60 H 60 P 33,2 apertura push-pull, 1 fianco come anta	E2060601/2	151
2	Elemento a giorno L 30 H 60 P 31 in polimerico 2 vani	E7700733	173
1	Elemento a giorno L 90 H 24 P 31 in polimerico 3 vani	E7700707	209
1	Pensile L 90 H 36 P 33,2 apertura vasistas, 1 fianco come anta	E2106900	256
1	Mensola L 180 H 3,8 P 33,2 in laminato	al ml 091560	104
2	Asta appendipensili ml 2	08610501	9
TOTALE			1.319
No. of ELEMENTS	DESCRIPTION	CODE	€ each
2	Wall unit W 60 H 60 D 33,2 push-pull opening, 1 side same as door	E2060601/2	151
2	Polymeric open unit W 30 H 60 D 31 with 2 compartments	E7700733	173
1	Polymeric open unit W 90 H 24 D 31 with 3 compartments	E7700707	209
1	Wall unit W 90 H 36 D 33,2 flap door opening, 1 side same as door	E2106900	256
1	Laminate shelf W 180 H 3,8 D 33,2	per lm 091560	104
2	Wall unit fixing strip mt. 2	08610501	9
TOTAL			1.319

STRUTTURA CONTENITIVA A PARETE

CONTAINMENT STRUCTURE TO WALL

Struttura contenitiva a parete in metallo verniciato bronzo titanio con mensole in metallo dello stesso colore, regolabili mediante un sistema a cremagliera (vedi particolare in foto). Disponibile nelle larghezze L 60 e L 90 entrambe nelle altezze H 132 e H 180

Containment structure to wall in painted metal bronze titanium with adjustable metal shelves same colour as structure, on a rack system (see detail in photos). Available in W 60 and W 90 for the H 132 and H 180

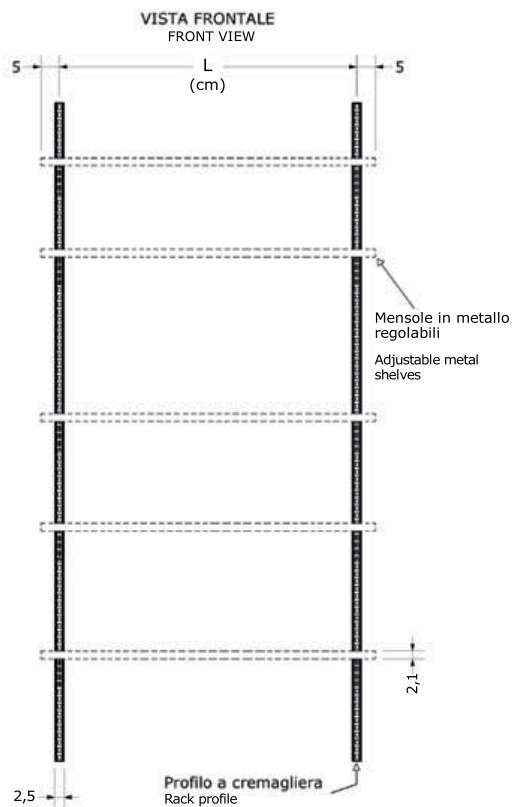

PARTICOLARE

Dettaglio della cremagliera per regolare la posizione delle mensole su tutta l'altezza del telaio

Rack system detail for adjust the position of shelves over the whole height of the frame

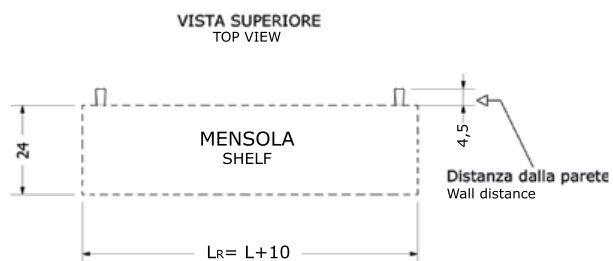

STRUTTURA CONTENITIVA A PARETE MODULARITÀ

CONTAINMENT STRUCTURE TO WALL MODULARITY

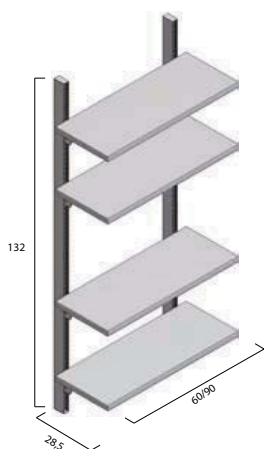

STRUTTURA A PARETE IN METALLO H 132 P 28,5

Composto da:

- 2 cremagliere
- 4 mensole regolabili

Structure to wall in titanium H 132 D 28,5

Consist of:

- 2 rack systems
- 4 adjustable shelves

L 60 cod.08903005 € 398

L 90 cod.08903010 € 480

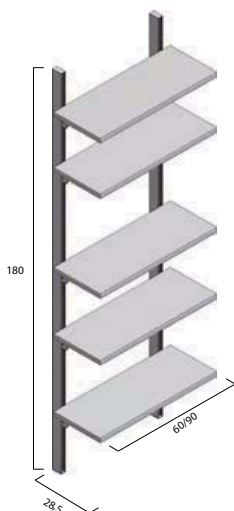

STRUTTURA A PARETE IN METALLO H 180 P 28,5

Composto da:

- 2 cremagliere
- 5 mensole regolabili

Structure to wall in titanium H 180 D 28,5

Consist of:

- 2 rack systems
- 5 adjustable shelves

L 60 cod.08903015 € 480

L 90 cod.08903020 € 583



STRUTTURA CONTENITIVA AD ISOLA

ISLAND CONTAINMENT STRUCTURE

Struttura contenitiva ad isola in metallo verniciato bronzo titanio con nr. 3 ripiani regolabili in laminato su cremagliera e nr. 1 ripiano fisso in laminato per conferire maggiore stabilità. Grazie ad un sistema modulare è inoltre possibile creare configurazioni personalizzate.

Island containment structure in painted metal bronze titanium with no. 3 laminate adjustable shelves on the rack and no. 1 laminate fixed shelf to give it more stability. Thanks to the modular system can create custom configurations.

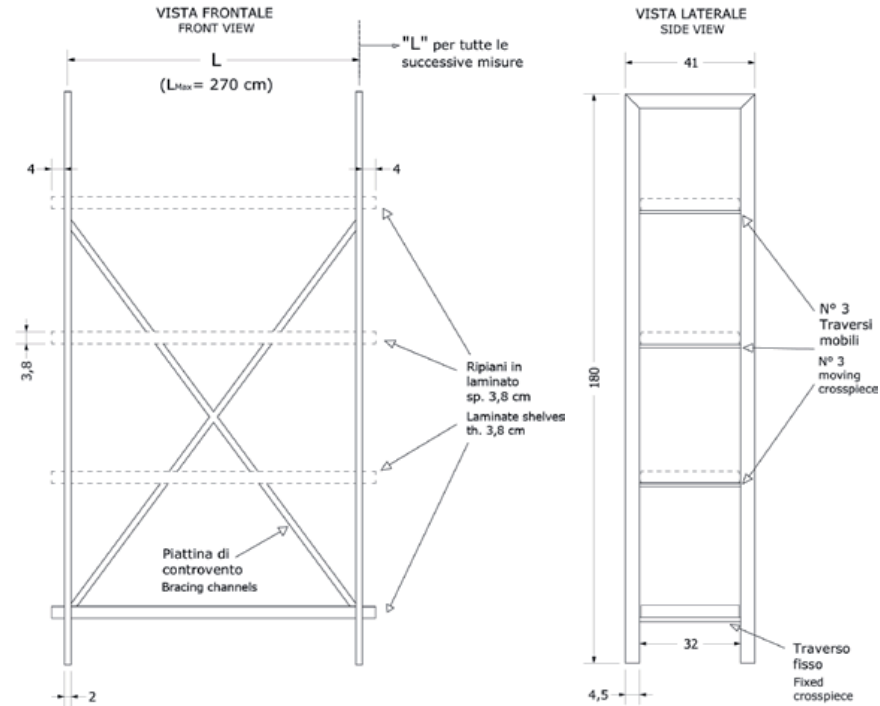

PARTICOLARE

Dettaglio della cremagliera per regolare la posizione dei ripiani su tutta l'altezza del telaio

Rack system detail for adjust the position of shelves over the whole height of the frame

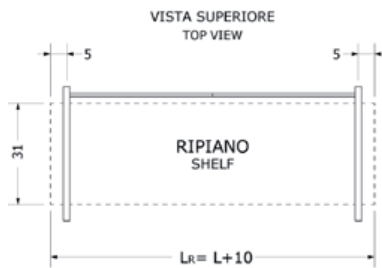

STRUTTURA CONTENITIVA AD ISOLA MODULARITÀ

ISLAND CONTAINMENT STRUCTURE MODULARITY

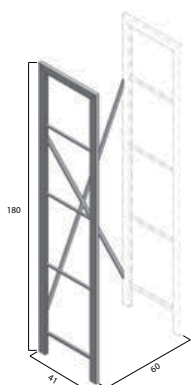

ELEMENTO STRUTTURA L 60 H 180 P 41

Composto da:

- 1 fianco con traverso fisso
- 3 traversi mobili
- 1 piattina di controvento

Structure element L 60 H 180 D 41

Consist of:

- 1 side element with fixed crosspiece
- 3 moving crosspieces
- 1 bracing channels

cod.08903055 € 174

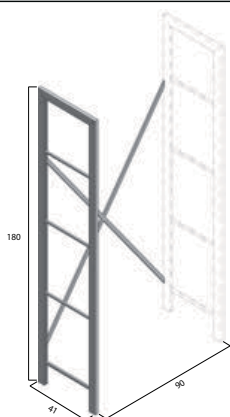

ELEMENTO STRUTTURA L 90 H 180 P 41

Composto da:

- 1 fianco con traverso fisso
- 3 traversi mobili
- 1 piattina di controvento

Structure element L 90 H 180 D 41

Consist of:

- 1 side element with fixed crosspiece
- 3 moving crosspieces
- 1 bracing channels

cod.08903060 € 177

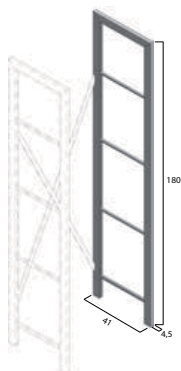

ELEMENTO TERMINALE STRUTTURA L 4,5 H 180 P 41

Composto da:

- 1 fianco con traverso fisso
- 3 traversi mobili

Structure terminal element L 4,5 H 180 D 41

Consist of:

- 1 side element with fixed crosspiece
- 3 moving crosspieces

cod.08903070 € 149

RIPIANO IN LAMINATO BORDATO 4 LATI H 3,8 P 31

Laminate shelf edged 4 sides H 3,8 D 31

Colori disponibili

Available colours

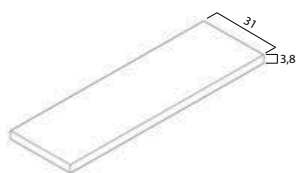

abete nordico
bianco (opz.4406)
white nordic fir

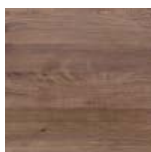

abete nordico
terra (opz.4407)
earth nordic fir

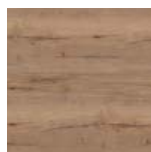

rovere naturale
vintage (opz.5310)
vintage natural oak

al ml cod.091529 € 76

STRUTTURA CONTENITIVA AD ISOLA ESEMPI DI COMPOSIZIONE

ISLAND CONTAINMENT STRUCTURE COMPOSITION EXAMPLES

ESEMPIO COMPOSIZIONE TIPO 1 L 190 € 1.081

- Elemento struttura L 90 H 180 P 41 € 177
- Elemento struttura L 90 H 180 P 41 € 177
- Elemento terminale struttura L 4,5 H 180 P 41 € 149
- 4 ripiani in laminato L 190 € 578

TYPE 1 COMPOSITION EXAMPLE W 190

- Structure element W 90 H 180 D 41
- Structure element W 90 H 180 D 41
- Structure terminal element W 4,5 H 180 D 41
- 4 laminate shelves W 190



Vista frontale
Front view

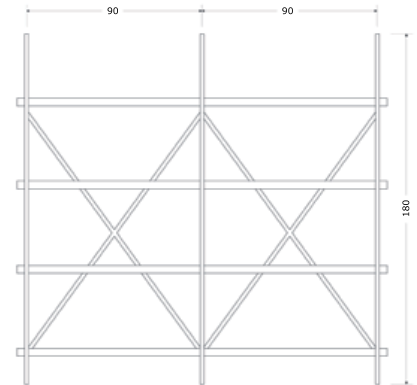

Vista superiore
Top view

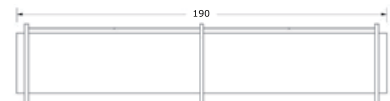

ESEMPIO COMPOSIZIONE TIPO 2 L 160 € 896

- Elemento struttura L 60 H 180 P 41 € 174
- Elemento struttura L 90 H 180 P 41 € 177
- Elemento terminale struttura L 4,5 H 180 P 41 € 149
- 2 ripiani in laminato L 100 € 152
- 2 ripiani in laminato L 160 € 244

TYPE 2 COMPOSITION EXAMPLE W 160

- Structure element W 60 H 180 D 41
- Structure element W 90 H 180 D 41
- Structure terminal element L 4,5 H 180 D 41
- 2 laminate shelves L 100
- 2 laminate shelves L 160



Vista frontale
Front view

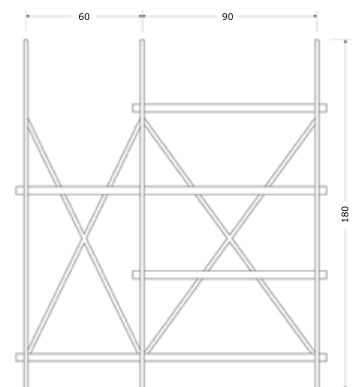

Vista superiore
Top view

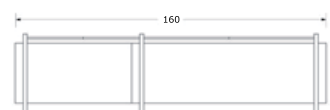



COMPOSIZIONE BASSA L 255 (con gola L 260)

LOW COMPOSITION W 255 (with finger rail W 260)



COMPOSIZIONE BASSA L 300 (con gola L 305)

LOW COMPOSITION W 300 (with finger rail W 305)



COMPOSIZIONE BASSA L 255 (con gola L 260)

LOW COMPOSITION W 255 (with finger rail W 260)

(IVA e contributo RAEE esclusi)

(VAT and WEEE fee excluded)

COMPONENTI COMPONENTS	versioni con maniglia KYRA handle versions
<p>Colonna 60 frigo-freezer 230 classe A+ 60 cm column fridge-freezer 230 class "A+"</p> <p>Base 45 2 cassetti e cestone 45 cm base unit with 2 drawers and deep drawer</p> <p>Base 60 forno statico nero con ventilazione tangenziale di raffreddamento static oven with orbital cooling ventilation 60 base unit</p> <p>Piano cottura 60 4 gas inox con valvola di sicurezza 60 cm stainless steel hob with 4 gas burners with safety valve</p> <p>Sottolavello 90 90 cm sink unit</p> <p>Lavello ad incasso 86 x 50 1 vasca inox prelucidato 86x50 cm built-in sink with 1 stainless steel bowl</p> <p>Pensile 45 H 72 45 cm wall unit H 72</p> <p>Cappa 60 aspirante estraibile H 63 1 motore 60 cm hood slide-out ducting H 63 1 motor</p> <p>Scolapiatti 90 H 72 90 cm plate rack H 72</p> <p>Top 195 P 61 in laminato H 4 195 cm laminate worktop D 61 H 4</p> <p>Asta appendipensili ml 2 2 lm wall unit fixing strip</p>	<p>MELAMINICO € 2.860</p> <p>POLIMERICO OPACO € 2.976</p> <p>POLIMERICO LUCIDO € 3.080</p> <p>LACCATO FASCIA "A" € 3.087</p> <p>LACCATO FASCIA "B" € 3.302</p> <p>LACCATO PELTRO € 3.667</p> <p>GLAKS € 3.861</p>
<p>(Elettrodomestici Indesit) (Indesit appliances)</p>	<p>versioni con gola KYRA NECK finger rail versions</p> <p>MELAMINICO € 3.177</p> <p>POLIMERICO OPACO € 3.397</p> <p>POLIMERICO LUCIDO € 3.560</p> <p>LACCATO FASCIA "A" € 3.497</p> <p>LACCATO FASCIA "B" € 3.789</p> <p>LACCATO PELTRO € 4.266</p> <p>GLAKS € 4.497</p>

COMPOSIZIONE BASSA L 300 (con gola L 305)

LOW COMPOSITION W 300 (with finger rail W 305)

(IVA e contributo RAEE esclusi)

(VAT and WEEE fee excluded)

COMPONENTI COMPONENTS	versioni con maniglia KYRA handle versions
<p>Colonna 60 frigo-freezer 230 classe A+ 60 cm column fridge-freezer 230 class "A+"</p> <p>Base 60 2 cassetti e cestone 60 cm base unit with 2 drawers and deep drawer</p> <p>Base 60 forno statico nero con ventilazione tangenziale di raffreddamento static oven with orbital cooling ventilation 60 base unit</p> <p>Piano cottura 60 4 gas inox con valvola di sicurezza 60 cm stainless steel hob with 4 gas burners with safety valve</p> <p>Base 60 60 cm base unit</p> <p>Sottolavello 60 60 cm sink unit</p> <p>Lavello ad incasso 86 x 50 1 vasca inox prelucidato 86x50 cm built-in sink with 1 stainless steel bowl</p> <p>Pensile 60 H 72 60 cm wall unit H 72</p> <p>Cappa 60 aspirante estraibile H 63 1 motore 60 cm hood slide-out ducting H 63 1 motor</p> <p>Pensile 60 H 72 60 cm wall unit H 72</p> <p>Scolapiatti 60 H 72 60 cm plate rack H 72</p> <p>Top 240 P 61 in laminato H 4 240 cm laminate worktop D 61 H 4</p> <p>Asta appendipensili ml 4 4 lm wall unit fixing strip</p>	<p>MELAMINICO € 3.083</p> <p>POLIMERICO OPACO € 3.227</p> <p>POLIMERICO LUCIDO € 3.345</p> <p>LACCATO FASCIA "A" € 3.360</p> <p>LACCATO FASCIA "B" € 3.605</p> <p>LACCATO PELTRO € 4.022</p> <p>GLAKS € 4.176</p>
<p>(Elettrodomestici Indesit) (Indesit appliances)</p>	<p>versioni con gola KYRA NECK finger rail versions</p> <p>MELAMINICO € 3.414</p> <p>POLIMERICO OPACO € 3.714</p> <p>POLIMERICO LUCIDO € 3.851</p> <p>LACCATO FASCIA "A" € 3.796</p> <p>LACCATO FASCIA "B" € 4.117</p> <p>LACCATO PELTRO € 4.648</p> <p>GLAKS € 4.839</p>

COMPOSIZIONE ALTA L 300 (con gola L 305)

HIGH COMPOSITION W 300 (with finger rail W 305)



COMPOSIZIONE BASSA L 360 (con gola L 365)

LOW COMPOSITION W 360 (with finger rail W 365)



COMPOSIZIONE ALTA L 300 (con gola L 305)

HIGH COMPOSITION W 300 (with finger rail W 305)

(IVA e contributo RAEE esclusi)

(VAT and WEEE fee excluded)

COMPONENTI COMPONENTS	versioni con maniglia KYRA handle versions
<p>Colonna 60 frigo-freezer 230 classe A+ 60 cm column fridge-freezer 230 class "A+"</p> <p>Base 60 2 cassetti e cestone 60 cm base unit with 2 drawers and deep drawer</p> <p>Base 60 forno statico nero con ventilazione tangenziale di raffreddamento static oven with orbital cooling ventilation 60 base unit</p> <p>Piano cottura 60 4 gas inox con valvola di sicurezza 60 cm stainless steel hob with 4 gas burners with safety valve</p> <p>Base 60 60 cm base unit</p> <p>Sottolavello 60 60 cm sink unit</p> <p>Lavello ad incasso 86 x 50 1 vasca inox prelucidato 86x50 cm built-in sink with 1 stainless steel bowl</p> <p>Pensile 60 H 72 60 cm wall unit H 72</p> <p>Cappa 60 aspirante estraibile H 63 1 motore 60 cm hood slide-out ducting H 63 1 motor</p> <p>Pensile 60 H 96 60 cm wall unit H 96</p> <p>Scolapiatti 60 H 96 60 cm plate rack H 96</p> <p>Top 240 P 61 in laminato H 4 240 cm laminate worktop D 61 H 4</p> <p>Mensola 120 P 31 sp. 3,8 120 cm shelf D 31 sp. 3,8</p> <p>Asta appendipensili ml 4 4 lm wall unit fixing strip</p>	<p>MELAMINICO € 3.259</p> <p>POLIMERICO OPACO € 3.547</p> <p>POLIMERICO LUCIDO € 3.689</p> <p>LACCATO FASCIA "A" € 3.651</p> <p>LACCATO FASCIA "B" € 3.924</p> <p>LACCATO PELTRO € 4.465</p> <p>GLAKS € 4.451</p> <p>versioni con gola KYRA NECK finger rail versions</p> <p>MELAMINICO € 3.610</p> <p>POLIMERICO OPACO € 4.021</p> <p>POLIMERICO LUCIDO € 4.229</p> <p>LACCATO FASCIA "A" € 4.119</p> <p>LACCATO FASCIA "B" € 4.467</p> <p>LACCATO PELTRO € 5.147</p> <p>GLAKS € 5.134</p>
<p>(Elettrodomestici Indesit) (Indesit appliances)</p>	

COMPOSIZIONE BASSA L 360 (con gola L 365)

LOW COMPOSITION W 360 (with finger rail W 365)

(IVA e contributo RAEE esclusi)

(VAT and WEEE fee excluded)

COMPONENTI COMPONENTS	versioni con maniglia KYRA handle versions
<p>Colonna 60 frigo-freezer 230 classe A+ 60 cm column fridge-freezer 230 class "A+"</p> <p>Colonna 60 con cestone, forno statico nero con ventilazione tangenziale di raffreddamento 60 column with deep drawer configured for static oven with orbital cooling ventilation</p> <p>Base 90 2 cassetti + cestone predisposto P.C. 90 cm base unit with 2 drawers + deep drawer configured for hob</p> <p>Piano cottura 60 4 gas inox con valvola di sicurezza 60 cm stainless steel hob with 4 gas burners with safety valve</p> <p>Base 60 60 cm base unit</p> <p>Sottolavello 90 90 cm sink unit</p> <p>Lavello ad incasso 86 x 50 1 vasca inox prelucidato 86x50 cm built-in sink with 1 stainless steel bowl</p> <p>Pensile 60 H 72 60 cm wall unit H 72</p> <p>Cappa 90 sempione acciaio inox satinato + vetro 90 cm sempione hood brushed stainless steel + glass</p> <p>Pensile 60 H 72 60 cm wall unit H 72</p> <p>Scolapiatti 90 H 72 90 cm plate rack H 72</p> <p>Top 240 P 61 in laminato H 4 240 cm laminate worktop D 61 H 4</p> <p>Top 60 P 61 in laminato H 4 60 cm laminate worktop D 61 H 4</p> <p>Asta appendipensili ml 4 4 lm wall unit fixing strip</p>	<p>MELAMINICO € 3.462</p> <p>POLIMERICO OPACO € 3.620</p> <p>POLIMERICO LUCIDO € 3.748</p> <p>LACCATO FASCIA "A" € 3.765</p> <p>LACCATO FASCIA "B" € 4.026</p> <p>LACCATO PELTRO € 4.425</p> <p>GLAKS € 4.644</p> <p>versioni con gola KYRA NECK finger rail versions</p> <p>MELAMINICO € 3.777</p> <p>POLIMERICO OPACO € 4.041</p> <p>POLIMERICO LUCIDO € 4.226</p> <p>LACCATO FASCIA "A" € 4.172</p> <p>LACCATO FASCIA "B" € 4.506</p> <p>LACCATO PELTRO € 4.993</p> <p>GLAKS € 5.254</p>
<p>(Elettrodomestici Indesit) (Indesit appliances)</p>	

RILEVAZIONE DEL FUORI SQUADRO

OUT-OF-PLUMB MEASUREMENTS

Per le composizioni ad angolo è importante rilevare l'esatta misura dell'angolo per il corretto montaggio della cucina.

Si tenga presente che la diagonale dell'angolo di 90° è di cm 141,4 (100x100).

For corner compositions, it is important to measure the corner precisely to ensure that the kitchen is correctly installed.

Bear in mind that diagonal segment opposite the 90° corner measures 141,4 (100x100)

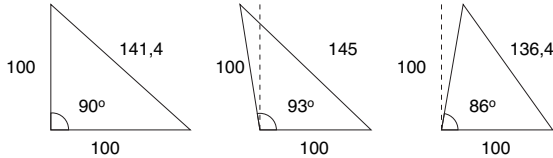

Riportiamo di seguito una tabella in cui sono riportate rispettivamente la misura dell'angolo con la diagonale corrispondente.

Below is a table indicating, respectively, the size of the corner and the length of the corresponding diagonal segment

ANGOLI SUPERIORI A 90°

CORNERS EXCEEDING 90°

angolo in gradi corner in degrees	diagonale in cm diagonal segment in cm
90	141,4
90,5	142
91	142,6
91,5	143,3
92	143,9
92,5	144,5
93	145
93,5	145,7
94	146,3
94,5	146,9
95	147,4
95,5	148
96	148,6
96,5	149,2
97	149,8
97,5	150,4
98	150,9
98,5	151,5
99	152,1
99,5	152,6
100	153,2

ANGOLI INFERIORI A 90°

CORNERS BELOW 90°

angolo in gradi corner in degrees	diagonale in cm diagonal segment in cm	aumento in cm della composizione increase in cm of the composition
90	141,4	-
89,5	140,8	-
89	140,2	-
88,5	139,5	-
88	138,9	-
87,5	138,3	-
87	137,7	-
86,5	137	-
86	136,4	-
85,5	135,8	1,5
85	135,1	2
84,5	134,5	2,5
84	133,8	3
83,5	133,2	3,5
83	132,5	4,5
82,5	131,9	5
82	131,2	6
81,5	130,5	6,5
81	129,9	8
80,5	129,2	8,5
80	128,5	9,5
79,5	127,9	10
79	127,2	10,5
78,5	126,5	11,5
78	125,8	12
77,5	125,2	12,5
77	124,5	13,5

ANGOLO MAGGIORE DI 90° CORNER EXCEEDING 90°

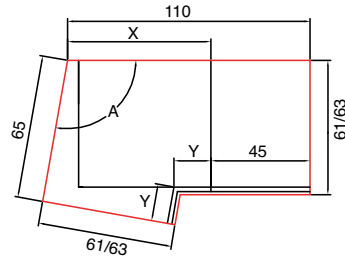

Nel caso in cui abbiamo un angolo maggiore di 90° le misure della base ad angolo non cambiano, ma viene aumentata la misura del massello angolare (Y).

N.B. per angoli maggiori di 110° interpellare sempre il nostro Ufficio Tecnico.

In case of corners exceeding 90°, the dimensions of the corner base unit do not change, while the size of the corner solid wood section (y) increases.

Note: for corners exceeding 110°, always contact our Technical Department.

ANGOLO COMPRESO TRA 86° E 90° CORNER BETWEEN 86° AND 90°

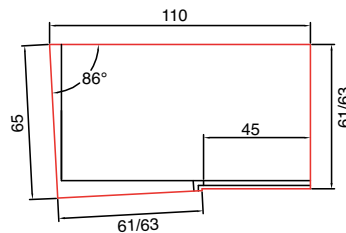

Nel caso in cui abbiamo un angolo compreso tra 86° e 90° le misure della base ad angolo non cambiano, ma viene diminuita la misura del massello angolare (Y).

Inoltre è necessario tener presente che di seguito alla base ad angolo non possono essere inserite basi forno, cassettiere, lavastoviglie, ma esclusivamente basi con anta incernierata sul fianco.

In case of corners between 86° and 90°, the dimensions of the corner base unit do not change, while the size of the corner solid wood section (y) decreases. Moreover, it is important to remember that oven base units, drawer units or dish-washers cannot be inserted next to the corner base unit, but only base units that have the door hinges on the side.

ANGOLO MINORE DI 86° CORNER BELOW 86°

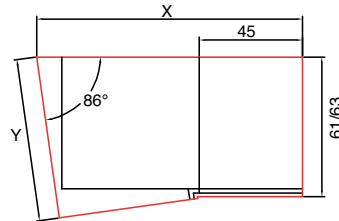

Quando l'angolo è inferiore a 86° la lunghezza della composizione viene aumentata in rapporto all'ampiezza dell'angolo (vedi tabella) per questo motivo è importante specificare nell'ordine le misure delle pareti da arredare.

Inoltre è necessario tener presente che di seguito alla base ad angolo non possono essere inserite basi forno, cassettiere, lavastoviglie, ma esclusivamente basi con anta incernierata sul fianco.

When the corner measures below 86°, the length of the composition increases in relation to the size of the corner (see table); for this reason, in the order it is important to specify the measurements of the walls to be furnished. Moreover, it is important to remember that oven base unit, drawer units or dish-washers cannot be inserted next to the corner base unit, but only base units that have the door hinges on the side.

RILEVAZIONE DEL FUORI SQUADRO

OUT-OF-PLUMB MEASUREMENTS

Nelle composizioni lineari dove a inizio o fine composizione c'è una parete fuori squadra prendere sempre la misura della diagonale e comunicarla al nostro Ufficio Tecnico.

In regards to linear compositions that have an out-of-plumb wall at the beginning or end of the composition, remember to always take the measurement of the diagonal segment and notify it to our Technical Department.

Nell'esempio n. 1 l'angolo è maggiore di 90° e quindi occorre aumentare il top davanti; la stessa cosa si deve fare per le basi, mettendo una fascia di tamponamento.

In example no.1, the corner exceeds 90°, thus the worktop must be extended on the front; the same applies to base units, where a filler panel must be added.

Nell'esempio n. 2 l'angolo è minore di 90° occorre accorciare la composizione; questo vale sia per il top che per le basi.

In example no.2, the corner is below 90°, therefore the composition must be shortened; this applies to both the worktop and base units.

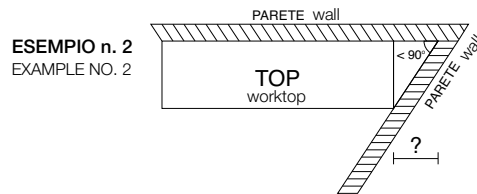
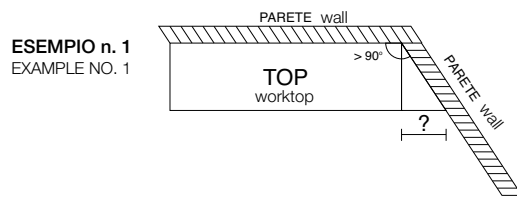

Nel caso in cui nell'angolo ci sia un pilastro, occorre rilevare oltre alle misure del pilastro anche le 3 diagonali come riportato nello schema (d1-d2-d3).

In case there is a pillar in the corner, we need to have the 3 diagonal measures as shown in the scheme (d1-d2-d3) other than the measures of the pillar itself

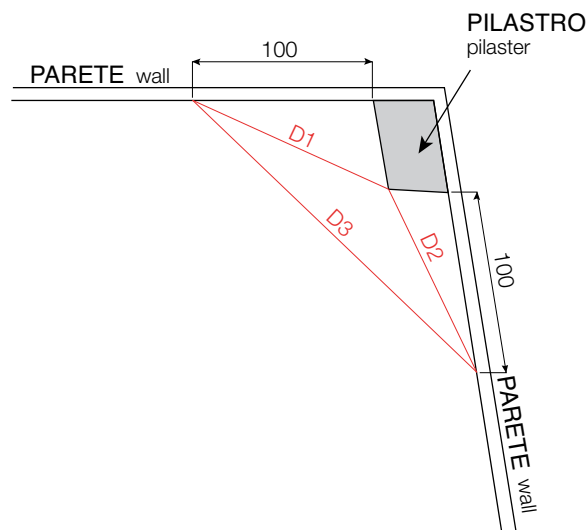

SCHEMA BASI E TOP TERMINALI

DIAGRAMS OF END BASE UNITS AND WORKTOPS

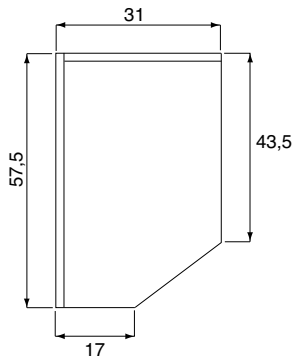

BASE TERMINALE
a giorno tipo "A"
Type "A"
open END BASE UNIT

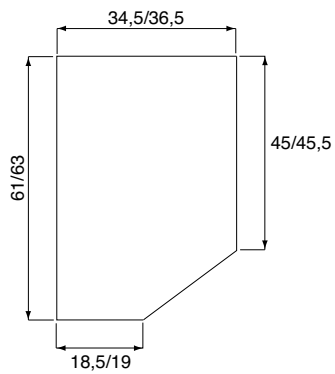

TOP PER BASE TERMINALE
a giorno tipo "A"
WORKTOP FOR type "A"
open END BASE UNIT

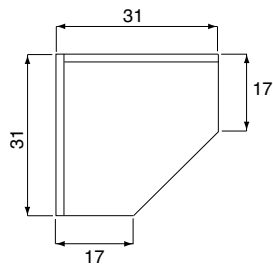

PENSILE TERMINALE
a giorno tipo "A"
Type "A"
open END WALL UNIT

INFORMAZIONI TECNICHE

TECHNICAL INFORMATION

POSIZIONAMENTO BARRA PER FISSAGGIO PENSILI

POSITIONING OF THE WALL UNIT FIXING STRIP

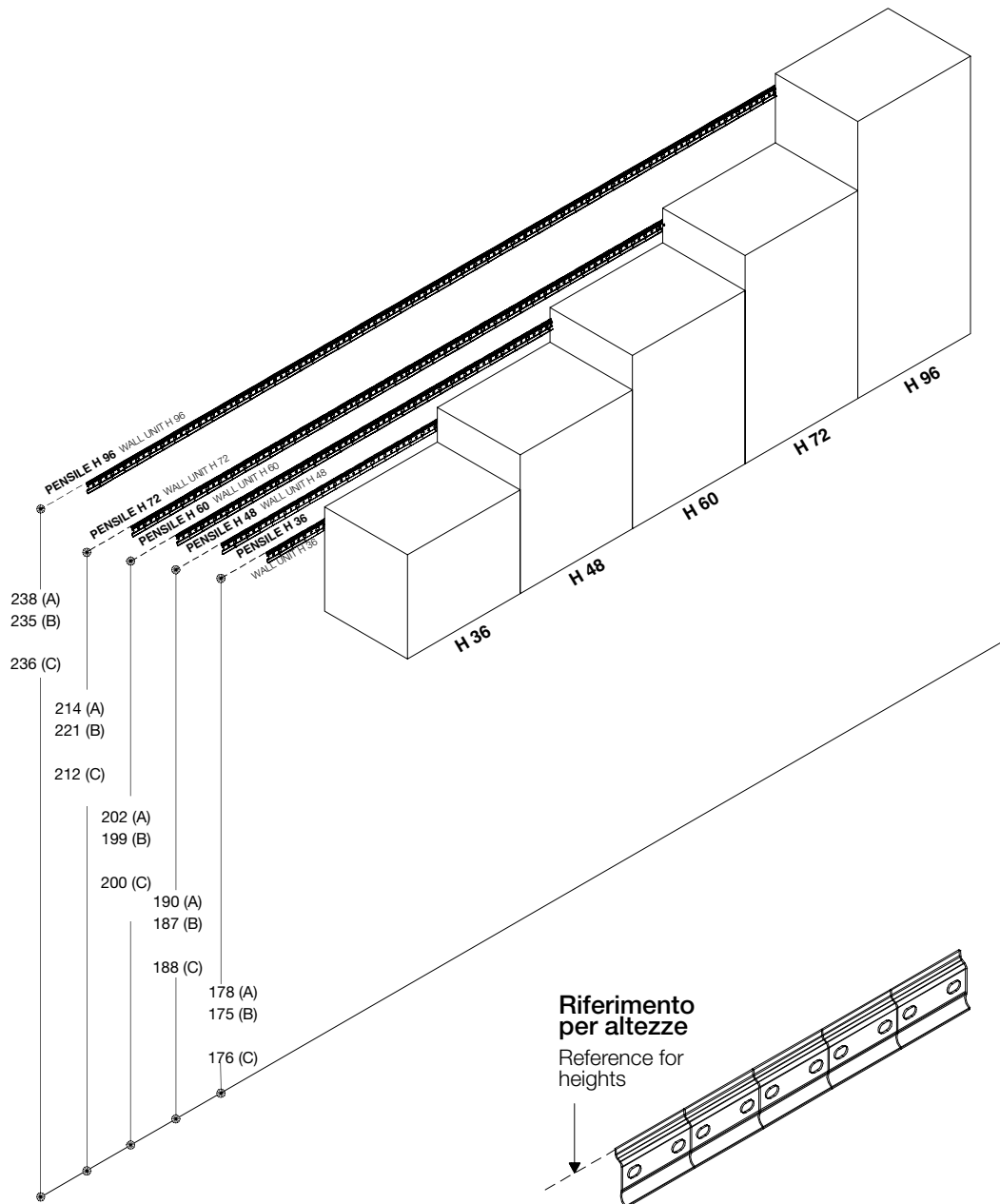

(A) Zoccolo H 15

(A) Plinth H 15

(B) Zoccolo H 12

(B) Plinth H 12

(C) Zoccolo H 13

(C) Plinth H 13

N.B.: in prossimità dell'attaccaglia, mettere minimo 2 fischer vicini, per dare una maggiore tenuta

Note: place at least 2 rawl plugs close together near fixing elements to increase the load bearing capacity

SCHEMA DI ALLACCIO IMPIANTO ELETTRICO IDRICO E GAS

POWER, WATER AND GAS NETWORKS CONNECTIONS DIAGRAM

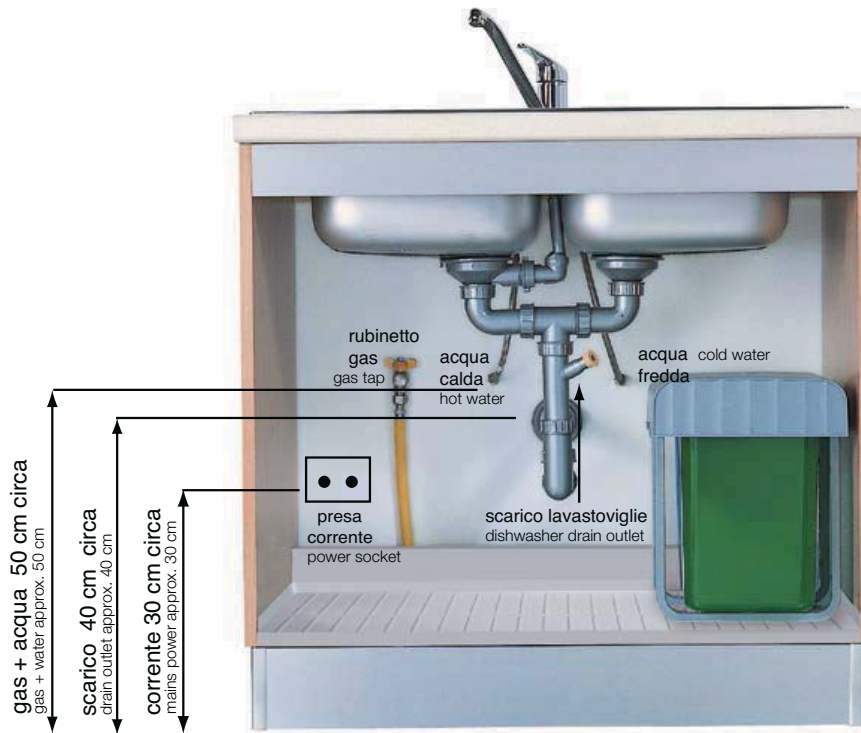

SOTTOLAVELLO CON ANTE
SINK BASE UNIT WITH DOORS

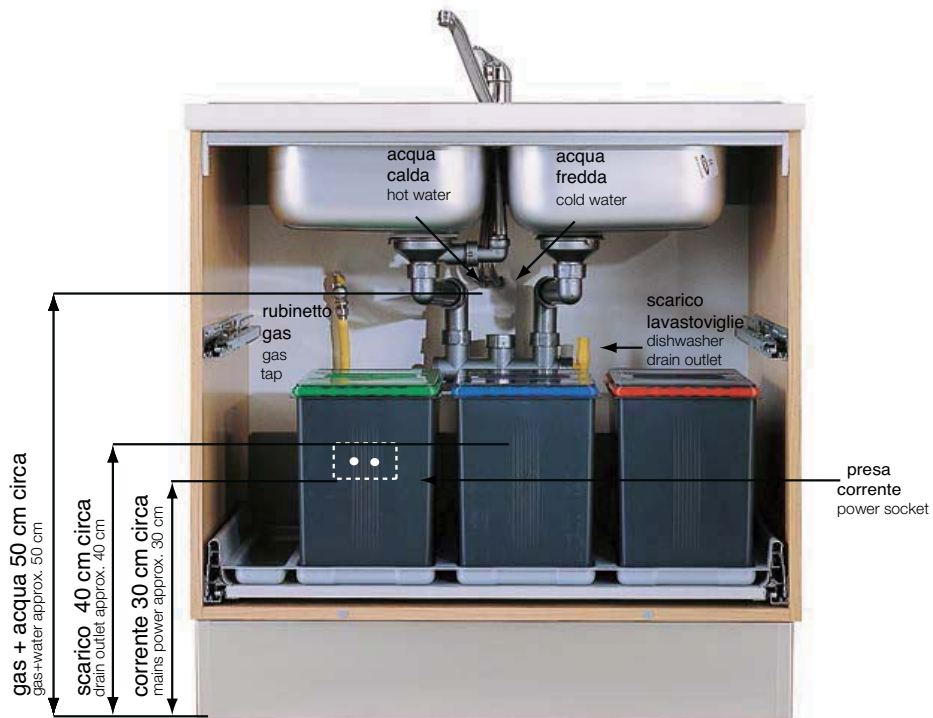

SOTTOLAVELLO 2 CESTONI CON SIFONE SALVASPAZIO
SINK BASE UNIT WITH 2 DEEP DRAWERS AND SPACE-SAVER DRAIN PIPING

INFORMAZIONI PER LA PROGETTAZIONE

DESIGN INFORMATION

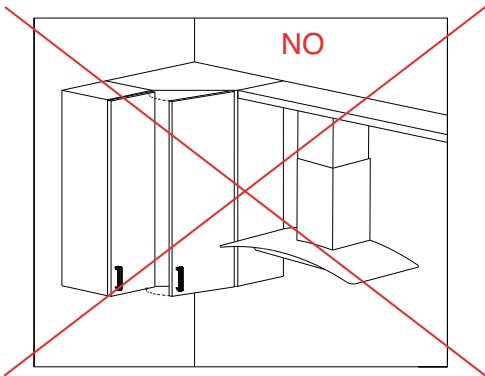

CAPPA A RIDOSSO DEL PENSILE ANGOLO HOOD ADJACENT TO CORNER WALL UNIT

Consigliamo di non posizionare una cappa d'arredamento a fianco di un pensile angolo 65x65 diagonale in quanto impedisce la corretta apertura dell'anta.

It is advisable not to install a design hood adjacent to a 65x65 cm diagonal corner wall unit, as this interferes with the opening of the wall unit door.

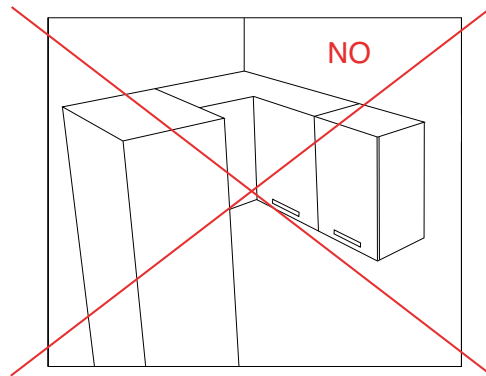

PENSILI ANGOLO A RIDOSSO DELLA COLONNA CORNER WALL UNITS NEXT TO THE TALL UNIT

Per problemi di apertura evitare composizioni angolari dove il pensile angolo è a ridosso della colonna

Avoid corner compositions where the corner wall unit is next to the column in order not to have problems in opening the doors

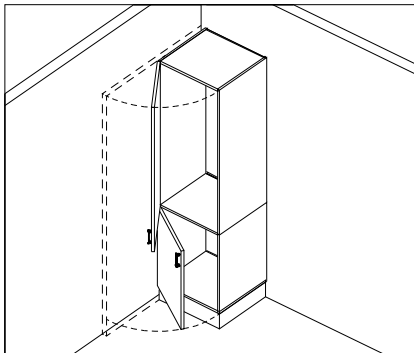

FRIGORIFERO VICINO AL MURO REFRIGERATOR NEAR THE WALL

Nel caso che una colonna frigorifero sia posizionata vicino ad una parete occorre lasciare uno spazio di almeno 4 cm per consentire una totale apertura dell'anta della colonna e l'estrazione totale dei cassetti dell'elettrodomestico.

If a fridge column is positioned close to a wall, leave at least 4 cm free to ensure the full opening of the column door and the full extension of the appliance's drawers.

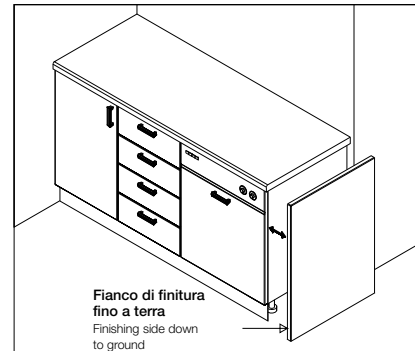

ELETTRODOMESTICO A FINE COMPOSIZIONE HOUSEHOLD APPLIANCE AT THE END OF A COMPOSITION

Nel caso che la lavastoviglie o la lavatrice sia posizionata a fine composizione occorre l'uso di un fianco di finitura fino a terra, considerando lo spessore dello stesso per determinare la lunghezza del top.

If a dishwasher or washing machine is placed at the end of a composition, it is necessary to install a finishing side down to ground; the latter's thickness must be considered when determining the length of the worktop.

INFORMAZIONI PER LA PROGETTAZIONE

DESIGN INFORMATION

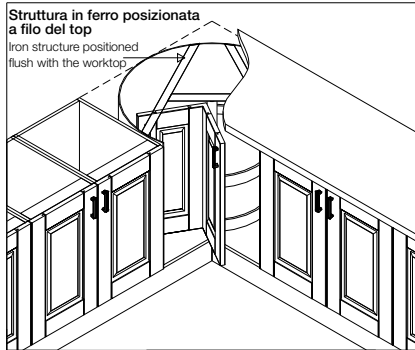

BASE ANGOLO 95x95 2 ANTE GIREVOLI 95x95 CORNER BASE UNIT WITH 2 SWIVEL DOORS

Non è possibile inserire gli elettrodomestici.
Household appliances cannot be inserted

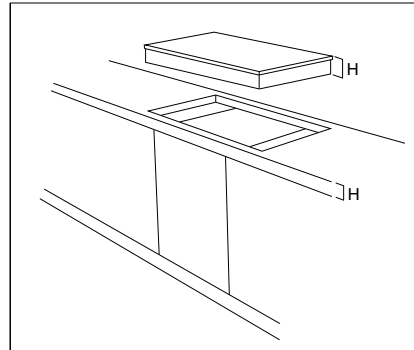

INCASSI PIANI COTTURA HOB CUT-OUT

Verificare sempre l'incasso (spessore top) dei piani cottura posizionati sopra qualsiasi elettrodomestico sottotop (lavastoviglie, frigorifero, ecc.)
Always check the cut-out of hobs (thickness of work top) where under counter appliances are positioned (dishwasher, fridge, etc...)

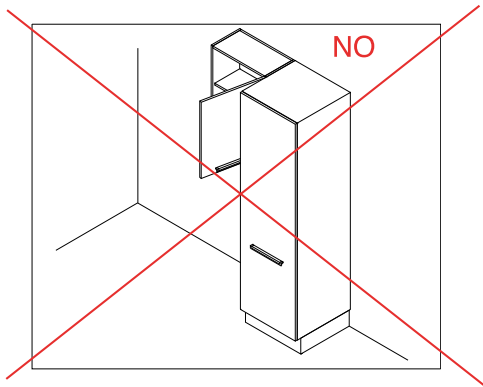

PENSILE ACCANTO ALLA COLONNA WALL UNIT NEXT TO A COLUMN

Evitare il posizionamento del pensile verso la colonna, in quanto non si ha una completa apertura dell'anta e si rischia di danneggiare il fianco.
Avoid placing a wall unit near the column, as this prevents the complete opening of the door and may cause the side to be damaged

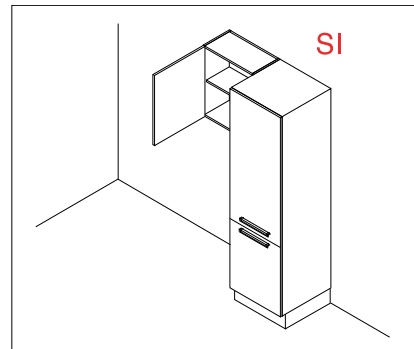

Si consiglia di utilizzare il pensile con l'apertura dell'anta opposta alla posizione della colonna con cerniere a 180°
It is advisable to use a wall unit with a door that opens in the opposite direction to the column's position, with 180° hinges.

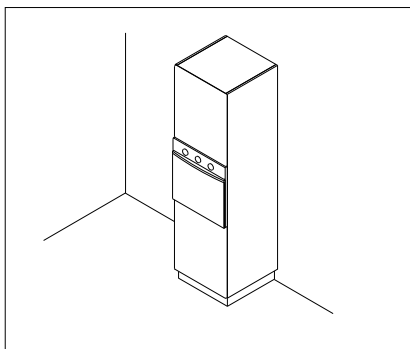

FORNI STATICI SENZA VENTILAZIONE NON-VENTILATED STATIC OVENS

Evitare l'abbinamento dei forni statici senza ventilazione di raffreddamento nelle colonne, poiché il calore e il vapore emanati durante il funzionamento dell'elettrodomestico possono danneggiare le antine e la struttura della colonna.
Avoid inserting non-ventilated static ovens in columns, as the heat and steam generated during the appliance's operation may damage the column's doors and carcass.

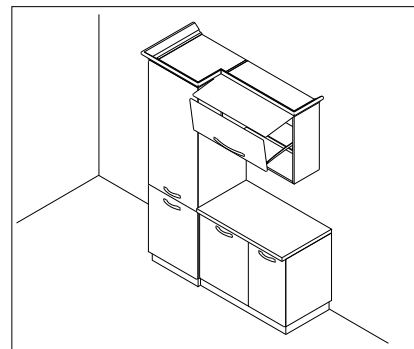

PENSILE A PACCHETTO WALL UNIT WITH LIFT-UP FOLDING DOOR

Per evitare nei pensili con apertura a pacchetto l'interferenza dell'anta in fase di apertura con cornici o mensole si può richiedere il limitatore dell'angolo di apertura cod.5620005 € 10
In order to avoid that the lift-up folding door interferes with cornices or shelves during the opening movement, it is possible to request an opening angle limiter code 5620005 € 10

INFORMAZIONI PER LA PROGETTAZIONE

DESIGN INFORMATION

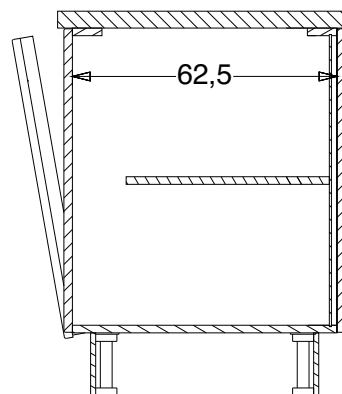
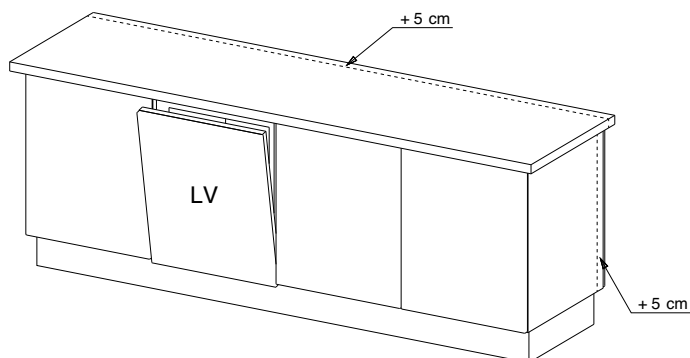

PENISOLE - ISOLE CON LAVASTOVIGLIE CON ZOCCOLO POSTERIORE

PENINSULAS - ISLANDS WITH DISHWASHER WITH BACK PLINTH

Nei casi di lavastoviglie, rifinita con zoccolo posteriore, inserita su isole o penisole è obbligatorio aumentare la profondità standard delle basi di 5 cm, con una maggiorazione del 18%

In case there is a dishwasher positioned in island or peninsula with back plinth, it's obligatory to add 5 cm extra to the depth of the bases, with a surcharge of 18%

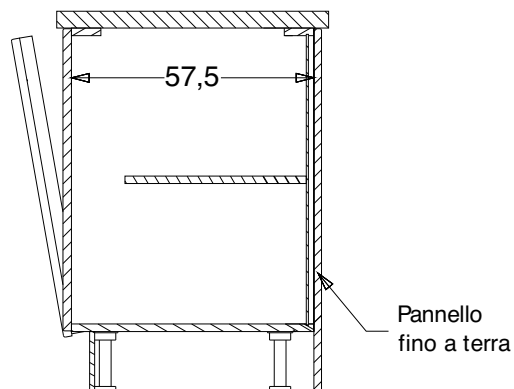
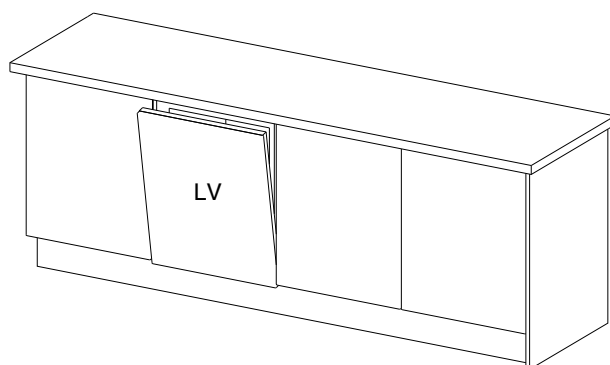

PENISOLE - ISOLE CON LAVASTOVIGLIE CON PANNELLO POSTERIORE

PENINSULAS - ISLANDS WITH DISHWASHER WITH BACK PANELS

In alternativa, lasciando la profondità di serie degli elementi, rifinire sempre con pannello posteriore fino a terra

Otherwise if keeping the standard depth, the back of the island must be refined with back panels down to floor

Handwriting practice lines consisting of 20 horizontal dotted lines.

CREOKITCHENS

LUBE INDUSTRIES SRL
via dell'Industria, 4 - 62010 Treia (MC) ITALY
P.IVA e Cod. Fisc. 01504060433

tel +39 0733 84.01 (ra)
fax + 39 0733 84.02.22 - 0733 84.03.33
www.creokitchens.it
info@creokitchens.it