

**CREO**  
KITCHENS

**MAGGIORAZIONE  
SURCHARGE**

**+ 8%**

**DAL 23 GENNAIO 2023  
FROM JANUARY 23, 2023**

**JEY FEEL** moderno

listino 2022

# CONDIZIONI GENERALI DI VENDITA

## DECORRENZA

Il presente listino sostituisce ed annulla tutti i precedenti.

Non costituisce offerta e può essere modificato, con comunicazione scritta dell'AZIENDA al Cliente, in qualsiasi momento anche senza preavviso.

Le modificazioni o gli aggiornamenti avranno efficacia rispetto a tutti gli ordinativi pervenuti o trasmessi all'AZIENDA dopo la comunicazione scritta di cui sopra.

## PREZZI DI LISTINO E CONDIZIONI DI PAGAMENTO

I prezzi sono quotati al pubblico I.V.A. e contributo RAEE esclusi e si intendono franco fabbrica.

Decorso il termine contrattuale di pagamento l'AZIENDA è autorizzata alla emissione di tratte a saldo di ogni suo avere maggiorate degli interessi, spese e di ogni altro onere accessorio, previa comunicazione al Cliente. In caso di pagamento oltre i termini contrattuali, saranno addebitati gli interessi ai sensi del D.lgs. 231/2002, oltre al recupero di eventuali sconti espressamente concessi in ragione del termine di pagamento.

In caso di mancato pagamento nei tempi contrattuali l'AZIENDA potrà sospendere l'evasione degli ordini in corso previa comunicazione al Cliente.

## CONSEGNA

I termini di consegna vengono computati in giorni lavorativi con decorrenza dal perfezionamento del contratto di vendita, che comunque si intende perfezionato entro 8 giorni dall'invio dell'ordine o comunque entro 8 giorni dall'ultimo chiarimento (se richiesto) fornito dal Cliente. I termini di consegna saranno prorogati automaticamente in dipendenza di avvenimenti non imputabili all'AZIENDA o a cause di forza maggiore. Sono sempre ammesse consegne parziali.

## PRODOTTO

I dati tecnici relativi ai prodotti illustrati nel presente listino sono puramente indicativi come indicativi. L'AZIENDA si riserva la facoltà di apportare tutte le modifiche tecnico-costruttive migliorative del prodotto, senza obbligo di preavviso. La merce potrà tuttavia presentare caratteristiche parzialmente difformi da quelle indicate nel listino e nel catalogo, e comunque non risultare del tutto identica ai campioni che eventualmente fossero stati visionati in occasione della effettuazione dell'ordine, dovendosi riconoscere margini di tolleranza per quanto concerne i colori e le tonalità. La conformità al campione non deve intendersi in senso tassativo. Ciò vale anche per gli elettrodomestici o altri accessori impiegati a corredo delle cucine; questi potranno risultare esteticamente leggermente difformi in base alle marche utilizzate diverse da quelle da catalogo, salvo la sostanziale conformità delle caratteristiche e delle funzioni. Il Cliente potrà richiedere elementi specifici indicandone la marca sempre nell'ambito del ventaglio di offerte dell'AZIENDA non assume alcuna responsabilità circa la tenuta dei supporti che dipendesse da insufficienza della parete a cui venissero applicati gli stessi poiché la verifica dell'idoneità della parete dovrà essere effettuata dal cliente.

## CONSISTENZA FINITURE

Le finiture potrebbero subire nel tempo modificazioni di colore dovute all'esposizione alla luce, al calore, ai vapori e all'invecchiamento. È, pertanto, naturale che in caso di successivi completamenti, si potranno avere delle differenze di tonalità che comunque dovrebbero tendere ad attenuarsi nel tempo. Per i piani in marmo e granito, considerando che il taglio proviene da BLOCCHI NATURALI, non possiamo garantire l'uniformità del colore e della grana. Questi fattori non potranno costituire motivo di contestazione o di resa del prodotto.

## TRASPORTO

La merce non viaggia mai con mezzi dell'AZIENDA e, di conseguenza, nel momento in cui questa viene affidata al vettore, a prescindere da chi lo abbia incaricato, o caricata nel mezzo del cliente tutti i rischi passano al cliente stesso. Il Cliente, anche tramite suoi incaricati, ha l'obbligo di controllare l'integrità della merce all'arrivo ed, eventualmente, fare le dovute contestazioni scritte al Vettore. Qualora il danno rende inutilizzabile la merce è opportuno non ritirarla dandone conto nel Documento di Trasporto, diversamente con l'apposizione della firma da parte del Cliente, senza alcuna contestazione e/o rilievo si attesta la perfetta integrità e conformità della merce.

## INSTALLAZIONE E IMPIEGO

L'AZIENDA declina ogni responsabilità per l'errata o impropria installazione del prodotto fornito (mobili, piani di lavoro, elettrodomestici, impianti elettrici o idraulici ecc.) siano essi di sua fabbricazione o di terzi, sempre che non provveda essa stessa alle predette operazioni. L'acquirente non potrà in nessun caso richiedere il risarcimento dei danni eventualmente causati in occasione dell'installazione. L'AZIENDA si ritiene esonerata da qualsiasi responsabilità circa il funzionamento degli elettrodomestici e degli accessori fabbricati da terzi costruttori, per i quali venga fornito dal predetto fabbricante lo specifico libretto di uso e manutenzione; nel libretto si troverà indicato l'eventuale Ufficio Reclami o i Centri di Assistenza del terzo fabbricante. Per l'impropria e/o inadeguata manutenzione, nonché per l'improprio e/o inadeguato utilizzo dei prodotti venduti, l'AZIENDA rinvia ogni e qualsiasi responsabilità e/o onere al Cliente o all'Utilizzatore.

## RECLAMI ED AZIONI

I vizi e i difetti devono essere denunciati all'AZIENDA nei termini di legge. Anche nel caso di contestazione i pagamenti non potranno essere sospesi. La merce rimarrà di proprietà dell'AZIENDA sino al pagamento totale da parte del committente.

## GARANZIA

La garanzia sui prodotti venduti opererà per il tempo che, di volta in volta, le leggi vigenti nel Paese del Cliente stabiliranno come minimo a favore dell'acquirente.

## RESTITUZIONE DI MERCE

La restituzione delle merci vendute si accetta solo se espressamente autorizzata dalla LUBE INDUSTRIES s.r.l.. Verranno concordate modalità di reintegro e di accredito, solo qualora la restituzione sia dovuta a fatti imputabili alla LUBE INDUSTRIES s.r.l.. La merce restituita dovrà essere consegnata in perfette condizioni e adeguatamente imballata. La merce da sostituire dovrà essere restituita senza ritardo dal commerciante alla fabbricante. Nel caso in cui detta merce sia restituita fino a sei mesi dalla sostituzione la fabbricante accrediterà al commerciante il cento per cento del valore della stessa; tra i sei e i nove mesi sarà accreditato al commerciante il settanta per cento del valore della merce; qualora la restituzione avvenga tra i nove ed i dodici mesi dalla sostituzione sarà accreditato al commerciante il cinquanta per cento del valore della merce; qualora la restituzione non sia compiuta nei dodici mesi non vi sarà accreditato nessun valore della merce sostituita.

## SPESE

Per i pagamenti a mezzo tratte o ricevute bancarie verranno addebitati tutti gli oneri accessori alla riscossione.

## CONTROVERSIE

Per ogni controversia il Foro competente sarà esclusivamente quello di Macerata.

## EFFICACIA

Il Cliente, con il solo fatto di conferire l'ordinativo, si dichiara edotto ed accetta tutte le condizioni di vendita che precedono, salvo espresso patto contrario.

## MARCHIO

Il marchio  è un marchio commerciale registrato, la proprietà dei diritti di utilizzazione economica appartengono esclusivamente a l'AZIENDA o a terzi, pertanto è espressamente vietato l'utilizzo senza il preventivo consenso scritto del proprietario. L'utilizzo del marchio da parte dei clienti ai fini pubblicitari dovrà comunque essere preventivamente autorizzato dall'AZIENDA previa presa visione del materiale prima della pubblicazione. In ogni caso il logo non potrà subire alcuna modifica od alterazione nelle forme e nei colori ne potrà essere associato a prezzi o sconti promozionali.

# GENERAL SALES CONDITIONS

## VALIDITY

This price list replaces and annuls all previous versions.

It does not constitute an offer and may be subject to change following a written notification by COMPANY to the Customer, at any time and without prior notice.

Any modifications or updates shall apply to all orders received by or transmitted to COMPANY following the above-mentioned written notification.

## RETAIL PRICES AND PAYMENT TERMS

The retail prices quoted are exclusive of VAT and the WEEE fee and are ex works.

Upon expiry of the agreed payment term, COMPANY shall be authorised to issue bills of exchange for any outstanding amounts on every item, plus interest, expenses and any other additional liability, prior notification to the Customer. In the event of payment after the agreed term, accrued interest shall be charged in compliance with Italian Legislative Decree no. 231/2002, while any discounts expressly granted in relation to the payment terms shall be recovered.

If payment is not received within the agreed terms, COMPANY shall be entitled to suspend fulfilment of current orders, prior notification to the Customer.

## DELIVERY

The delivery term is calculated in working days and takes effect from the date on which the sales contract is stipulated. In any case, the contract is considered effective within 8 days from order transmission or, at all events, within 8 days from the most recent clarification (if requested) provided by the Customer. The delivery term shall be automatically extended should any events occur that are not imputable to COMPANY or that are due to force majeure. Partial deliveries can always be effected.

## THE PRODUCT

Any technical data relating to the products illustrated in this price list is purely indicative. The COMPANY reserves the right to effect any technical or structural modifications to improve the product, without prior notice. The goods may differ to some extent from the specifications given in the price list and the catalogue, or not be identical in all aspects to the samples viewed at the time of the order, since tolerances in relation to colours and tonalities are inevitable. Conformity with the samples is not obligatory. This right extends to household appliances or other kitchen furniture accessories; the appearance of the latter may differ slightly depending on the brand in question (which may differ from that shown in the catalogue), without prejudice to the basic conformity of features and functions. The Client may request specific components of a given brand from the range of products offered by the COMPANY, which is not liable in any way for the load bearing capacity of supports depending on the characteristics of the walls to which they are mounted; the Client alone is responsible for ensuring that the walls are able to support the load.

## CONSISTENCY OF THE FINISHES

The finishes may be subject to slight changes in colour over time as a result of exposure to light, heat, vapours and ageing. Therefore, in the event of completion orders, there may be shade differences that will tend to diminish over time. Regarding marble and granite worktops, we cannot guarantee uniformity of colour and vein pattern as the worktops are cut from NATURAL BLOCKS. These factors may not provide grounds for claims or return of products.

## TRANSPORT

The goods never travel on vehicles owned by COMPANY; therefore, from the moment the goods are handed over to the forwarder and regardless of who entrusted the latter with the transport or loaded the goods into the customer's vehicle, all risks are transferred to the customer. The Customer - also through persons delegated by the latter - is obliged to check the integrity of the goods upon their arrival, and to notify written claims to the Forwarder. The Customer should not accept any damaged goods that are unsuitable for their intended use, and should notify the relevant claim on the transport document; otherwise, by signing the transport document without adding any claims and/or observations, the Customer certifies the integrity and conformity of the goods.

## INSTALLATION AND USE

The COMPANY is not liable for incorrect or improper installation of the supplied product (units, tops, household appliances, electrical and plumbing systems, etc.), whether manufactured by the company or by third parties, unless the COMPANY itself does the installation. The purchaser may not claim for any damages caused during installation. Moreover, the COMPANY is not liable for the operation of household appliances and accessories manufactured by third parties, for which user and maintenance manuals are provided by the manufacturer in question; the manuals include information regarding the Claims Office or Technical Assistance Centres of the third party manufacturer. As regards improper and/or inadequate maintenance, or any improper and/or inadequate use of the products sold, the COMPANY transfers all liability and/or resulting costs to the Client or User.

## CLAIMS

Any faults or defects must be reported to COMPANY within the terms specified by the law. Payment may not be suspended, even in the event of notification of claims.

The goods shall remain the property of COMPANY unless fully paid by customer.

## WARRANTY

Warranty on sold products in favour of the purchaser shall apply for the minimum duration specified case-by-case by the laws in force in the Customer's country.

## RETURN OF GOODS

Return of sold goods is only accepted if expressly authorised by LUBE INDUSTRIES s.r.l.. Replacement or reimbursement of said goods shall be mutually defined only if the goods return is due to events imputable to LUBE INDUSTRIES s.r.l.. The returned goods must be delivered in perfect conditions and suitably packaged.

The goods to be replaced must be returned from the retailer to the producer without delay. In the case that the goods are returned until six months after replacing the producer will credit the retailer 100% of the replaced goods value; between six and nine months after replacing, the producer will credit the retailer 70% of the replaced goods value; if the return is between nine and twelve months after the replacement, will be credited to the retailer 50% of the replaced goods value; if the refund is not made within twelve months will not be credited any of the replaced goods value.

## EXPENSES

For payments effected through bill of exchange or cash order, all additional collection expenses shall be charged.

## DISPUTES

The Court of Macerata shall have sole jurisdiction for any disputes that may arise.

## EFFECTIVENESS

For the sole fact of conferring the order, the Customer declares to be informed and accepts all the aforementioned sale conditions, unless otherwise expressly agreed on.

## BRAND

The trademark  is registered; the right of the commercial exploitation belongs only to the COMPANY or a third party, and the trademark may not be used without the owner's written consent. The client may only use the trademark for reasons of publicity if authorised in advance by COMPANY, following review of the material before publication.

In any case, the logo may not be modified or altered in form or colour, nor may it be associated with promotional prices or discounts.

## INFORMAZIONI TECNICHE

### TECHNICAL INFORMATION

Le misure indicate nel presente listino sono espresse in cm.

Le profondità delle basi si intendono comprensive di top.

Le profondità dei pensili e delle colonne si intendono comprensive di ante.

Le altezze delle basi e delle colonne si intendono comprensive di zoccolo

Il verso degli elementi è individuato dalla posizione delle cerniere. Fanno eccezione solo l'angolo base e la colonna ad angolo dove il verso viene individuato dalla posizione dell'anta rispetto al mobile.

Per gli elementi con il verso, è stato inserito il codice con entrambi i versi (ad esempio una base da cm 45 cod. E4010451/2).

Sarà quindi necessario specificare se l'ultima cifra dovrà essere "1" per il verso destro cioè E4010451 oppure "2" per il verso sinistro cioè E4010452.

Per i lavelli il verso dx o sx è individuato dalla posizione delle vasche.

I prezzi indicati sono espressi all'unità di euro e sono IVA e contributo RAEE esclusi

I prezzi delle basi e delle colonne sono comprensivi dello zoccolo standard.

Per tutti i mobili fuori misura ha valore il listino riportato nella pagina maggiorazioni fuori misura.

Nel caso vengano richieste maniglie con passo diverso da quello previsto dal modello, le ante verranno fornite senza fori maniglia.

**I colori delle immagini riportate nel presente listino sono solamente indicativi e non possono essere utilizzati come riferimento.**

The measurements appearing in this price list are expressed in cm.

The depths of base units are inclusive of the worktop.

The depths of the wall units and columns are inclusive of the doors.

The heights of the base units and columns are inclusive of the plinth.

The direction of the elements is determined by the position of the hinges. The only exceptions are the corner base unit and corner column, where the direction is determined by the position of the door in relation to the cabinet.

For elements that come with a direction, the code includes both directions (e.g. 45 cm base unit - code E4010451/2).

It is therefore necessary to specify the last figure - "1" for the RH direction, i.e. E4010451, or "2" for the LH direction, i.e. E4010452.

The RH or LH direction of the sinks is determined by the position of the bowls.

The prices indicated are expressed in units of Euro and exclude VAT and the WEEE fee.

Prices of the base units and columns are inclusive of the standard plinth.

The prices that apply to all custom-sized cabinets are indicated on the page "Surcharges for custom-sized elements".

In the event of handles requested with a different centre-to-centre distance compared to the standard for the model, the doors will be supplied without pre-drilled holes for the handles.

**The colours in the pictures appearing in this price list are purely indicative and should not be used as reference.**

## COMPOSIZIONI SENZA ELETTRODOMESTICI E SENZA TOP

### COMPOSITIONS WITHOUT HOUSEHOLD APPLIANCES AND WORKTOP

**Tutte le composizioni richieste prive di elettrodomestici (frigo, forno, piano cottura, lavastoviglie o lavatrice), saranno aumentate di un importo netto pari a € 150 iva esclusa. Tale direttiva non si applica se la cucina contiene almeno due di questi elettrodomestici.**

**Tutte le composizioni richieste prive di top, saranno aumentate di un importo netto pari a € 100 iva esclusa.**

All compositions requested without household appliances (fridge, oven, cooker hob, dishwasher or washing machine) shall be subject to a price increase of € 150 VAT excluded.

This measure does not apply if the kitchen contains at least two of the above-mentioned appliances.

All compositions requested without worktop shall be subject to a price increase of € 100 VAT excluded.

# ELEMENTI FUORI MISURA

CUSTOM-SIZED ELEMENTS

<b>MODELLI</b> MODELS	<b>MODIFICABILE IN LARGHEZZA</b> WIDTH ADJUSTABLE	<b>MODIFICABILE IN ALTEZZA</b> HEIGHT ADJUSTABLE
<b>JEY FEEL</b>	<b>SI</b> YES	<b>SI</b> YES

L'AZIENDA si riserva di accettare o meno la realizzazione di fuori misura di notevole difficoltà tecnica, previo invio di un disegno e successiva autorizzazione del ns. ufficio tecnico. Il prezzo di tali fuori misura sarà stabilito di volta in volta. Si intende che gli elementi fuori misura realizzati su Vs. richiesta, non saranno oggetto di ritiro.

COMPANY reserves the right to accept or decline processing of custom-sized elements that imply significant technical difficulties, subject to transmission of the drawing and subsequent authorisation by our Technical Dept. The price of these custom-sized elements shall be defined case-by-case. Any custom-sized elements manufactured on your request shall not be collected in the event of claims.

# MAGGIORAZIONI PER ELEMENTI FUORI MISURA

## SURCHARGES FOR CUSTOM-SIZED ELEMENTS

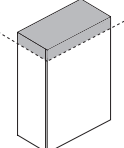
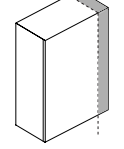
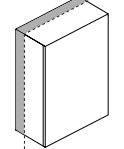
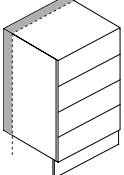
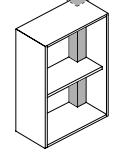
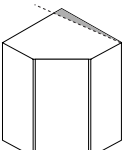
	DESCRIZIONE DESCRIPTION	MAGGIORAZIONE SURCHARGE		DESCRIZIONE DESCRIPTION	MAGGIORAZIONE SURCHARGE
	Riduzioni in altezza Height reduction			Basi angolo fuori squadra Out-of-plumb corner base units	
		<b>Basi</b> Base units + 25 %			
		<b>Pensili</b> Wall units + 25 %			
		<b>Colonne</b> Columns + 25 %			+ 28 %
	Riduzioni in larghezza Width reduction			Basi e sottolavelli con portabombola Base and sink base units with cylinder holder	
		<b>Basi</b> Base units + 28 %			
		<b>Pensili</b> Wall units + 28 %			
		<b>Colonne</b> Columns + 28 %			+ 20 €
	Riduzioni in profondità Depth reduction			Maggiorazioni per fianco scavato per inserimento piano cottura tra due basi (PPC opz. 011/012) Surcharge for digged side to insert cooking hob between two bases (PPC opt. 011/012)	
		<b>Basi</b> Base units + 18 %			
		<b>Pensili</b> Wall units + 18 %			
		<b>Colonne</b> Columns + 18 %			<b>Cadauno</b> each + 23 €
	Riduzioni per cassettera N.B.: modificabili solo in profondità fino a 31 cm al fianco Reductions for drawer unit Note: can only be modified depth-wise up to 31 cm on the side			Maggiorazioni per raggiatura mensola in laminato Surcharges for rounded edge on laminate shelf	
		+ 18 %			<b>Codice</b> code T9STP + 38 €
	Taglio per pilastro N.B.: non realizzabile nei pensili con meccanismi Indent for pilaster Note: not feasible on wall units with mechanisms			Maggiorazione per inserimento tubo cappa (da sommare al prezzo del pensile) Surcharge for insertion of the hood pipe (to be added to the price of the wall unit)	
		<b>Basi</b> Base units <b>Cod. T9SCB</b> + 90 €			
		<b>Pensili</b> Wall units <b>Cod. T9SCB</b> + 90 €			
		<b>Colonne</b> Columns <b>Cod. T9SCC</b> + 130 €			+ 90 €
	Pensili angolo fuori squadra Out-of-plumb corner wall units			Maggiorazione per inserimento cappa non standard N.B.: verificare sempre la fattibilità dell'incasso con il nostro ufficio tecnico Surcharge for the insertion of a non-standard hood Note: always verify the feasibility of the installation	
		+ 28 %			+ 90 €

La maggiorazione è da applicare al prezzo dell'elemento di serie più grande rispetto a quello delle dimensioni richieste.

Negli elementi fuori misura per motivi di lavorazione, l'estetica può risultare inferiore agli elementi di serie.

The surcharge applies to the price of the standard element that is next largest to that of the requested size.

Due to the processing involved, the aesthetic level of custom-sized elements may be slightly inferior to that of standard elements.

# jey feel

Cucina e living caratterizzati da effetti luminosi, vellutati, delicati. Questa è la nuova Jey Feel, progettata per soddisfare le esigenze di chi desidera una cucina moderna con un tocco urban chic. Jey Feel si distingue per i nuovi decorativi: palette materico-cromatiche che consentono di personalizzare al massimo il proprio spazio e di renderlo unico e assolutamente consono alle proprie esigenze. Le basi e le colonne si presentano lisce in diverse essenze e colori, anche abbinabili tra loro grazie alla tenuità delle nuance. Gli elementi a giorno si inseriscono nella composizione creando movimento tra vuoti e pieni. L'ampia offerta di finiture e di dettagli la rendono speciale sotto tutti i punti di vista.

Jey Feel è un concetto di cucina che si esprime in modo semplice e diretto e che coniuga i valori di stile, funzionalità e convivialità propri del Gruppo Lube.





## CREO ECOLOGIC

IL GRUPPO LUBE HA SCELTO DI UTILIZZARE PER I COMPONENTI COSTITUENTI LE STRUTTURE DELLE CUCINE SOLO MATERIALE A BASSISSIMA EMISSIONE DI FORMALDEIDE: CONFORMI ALLO STANDARD F4STELLE SECONDO LA NORMA JIS, CERTIFICATO DAL MINISTERO GIAPPONESE, IL PIU' SEVERO IN MERITO ALLE NORMATIVE DI SALVAGUARDIA AMBIENTALE.

Regarding the production of its kitchen structure components, lube group has decided to only use materials featuring very low formaldehyde emissions complying with the 4-star standard, as defined by the jis regulation. This standard is certified by the japanese government-the most rigorous when it comes to environmental protection.

Kitchen and living area characterized by luminous, velvety and delicate effects. This is the new Jey Feel model, designed to meet the needs of those who desire to have a modern kitchen with a urban-chic touch. Jey Feel stands out for its new finish decorations: textured-chromatic palettes that allow customizing the space making it unique and suitable to your own needs. Base units and tall units are smooth in different essences and colors, which is possible to combine thanks to the nuance softness.

Open elements fit into the composition creating dynamism between empty and full. The wide range of finishes and details make it special from all points of view. Jey Feel is a kitchen concept that expresses itself in a simple and direct way, combining all the Gruppo Lube values: style, functionality and conviviality.





## CARATTERISTICHE TECNICHE

### ANTE E FRONTALI CASSETTI

anta sp. 22 mm in melaminico, finitura real touch fiamma orizzontale nei colori: rovere silver (opz.5306), rovere diamond (opz.5307)

anta sp.22 mm in melaminico, finitura materica fiamma verticale (presa maniglia fiamma orizzontale) nei colori: rovere tabià (opz.5309), rovere ortisei (opz.5305)

anta sp. 22 mm in melaminico, finitura stone nei colori: black (opz.7863), white (opz.7448)

anta sp. 22 mm in melaminico, finitura opaca marmorizzata nel colore: trani (opz.7704)

anta sp. 22 mm in melaminico, finitura top matt nei colori: grigio agata (opz.9625), bianco assoluto (opz.7443)

anta sp. 22 mm in melaminico, finitura ovatta nei colori: grigio inox (opz.9624), rosso cardinale (opz.8123)

### ANTA VETRO

**di serie:** telaio in alluminio finitura brill sp.22 mm, vetro satinato sp.4 mm, senza maniglia  
 telaio in alluminio finitura selce sp.22 mm, vetro bronzo sp.4 mm, senza maniglia  
 telaio in alluminio finitura silver dark sp.22 mm, vetro satinato sp.4 mm, senza maniglia

### MANIGLIA

la presa maniglia è inclusa sull'anta

### STRUTTURE DI SERIE

**ANTE: ROVERE DIAMOND, BIANCO ASSOLUTO, WHITE**  
 nobilitato bianco (opz.001), schiena e ripiano bianco (opz.001)

**ANTE: TRANI, GRIGIO INOX**  
 nobilitato conchiglia (opz.8910) schiena e ripiano conchiglia (opz.8910)

**ANTE: ROVERE SILVER, GRIGIO AGATA**  
 nobilitato argilla (opz.9690) schiena e ripiano argilla (opz.9690)

**ANTA: ROVERE TABIÀ**  
 nobilitato fango (opz.8860) schiena e ripiano fango (opz.8860)

**ANTE: ROVERE ORTISEI, ROSSO CARDINALE**  
 nobilitato visone (opz.948M) schiena e ripiano visone (opz.948M)

**ANTA: BLACK**  
 nobilitato lavagna (opz.9620) schiena e ripiano lavagna (opz.9620)

### MENSOLE

**di serie:** altezza 3,8 cm in laminato bianco (opz.001), conchiglia (opz.8910), argilla (opz.9690), visone (opz.948M), fango (opz.8860), lavagna (opz.9620)

**a richiesta:** altezza 3,8 cm in laminato finiture come ante

### ZOCOLI

**di serie:** altezza 13 cm in pvc ricoperti in melamina finitura acciaio (opz.407)

**a richiesta:** altezza 13 cm in pvc ricoperti in melamina finitura alluminio satinato (opz.405), bianco (opz.001)  
 altezza 13 cm in alluminio liscio finitura brill (opz.412), alluminio finitura titanio ossidato (opz.414), [vedi maggiorazioni a pag.14](#)  
 altezza 13 cm in alluminio verniciato a polvere finitura opaca nei colori [vedi pag.15](#)



## TECHNICAL SPECIFICATIONS

### DOORS AND DRAWER FRONT PANELS

door Th. 22 mm, melamine-coated, real touch finish with horizontal grain, available in the following colours: silver oak (opt.5306), diamond oak (opt.5307)

door Th. 22 mm, melamine-coated, textured finish with vertical grain, (handle grip horizontal grain) available in the following colours: tabià oak (opt.5309), ortisei oak (opt.5305)

door Th. 22 mm, melamine-coated, stone finish available in the following colours: black (opt.7863), white (opt.7448)

door Th. 22 mm, melamine-coated, matt marble effect finish available in the following colour: trani (opt.7704)

door Th. 22 mm, melamine-coated, matt worktop finish available in the following colours: agata grey (opt.9625), absolute white (opt.7443)

door Th. 22 mm, melamine-coated, wadding finish available in the following colours: stainless steel grey (opt.9624), cardinal red (opt.8123)

### GLASS DOOR

**standard:** aluminium frame in brill Th.22 mm, satin glass Th.4 mm, without handle  
aluminium frame in flint Th.22 mm, satin glass Th.4 mm, without handle  
aluminium frame in dark silver Th.22 mm, satin glass Th.4 mm, without handle

### HANDLE

the handle grip is included on the door

### STANDARD STRUCTURES

**DOORS: DIAMOND OAK, ABSOLUTE WHITE, WHITE**  
melamine-coated white (opt.001), white back panel and shelf (opt.001)

**DOORS: TRANI, STAINLESS STEEL GREY**  
melamine-coated shell (opt.8910), shell back panel and shelf (opt.8910)

**DOORS: SILVER OAK, AGATA GREY**  
melamine-coated clay (opt.9690), clay back panel and shelf (opt.9690)

**DOOR: TABIÀ OAK**  
melamine-coated mud (opt.8860), mud back panel and shelf (opt.8860)

**DOORS: ORTISEI OAK, CARDINAL RED**  
melamine-coated mink (opt.948M), mink back panel and shelf (opt.948M)

**DOOR: BLACK**  
melamine-coated slate grey (opt.9620), slate grey back panel and shelf (opt.9620)

### SHELVES

**standard:** height 3.8 cm, laminate white (opt.001), shell (opt.8910), clay (opt.9690), mink (opt.948M), mud (opt.8860), slate grey (opt.9620)

**on request:** height 3.8 cm, laminate with same finish as doors

### PLINTHS

**standard:** height 13 cm, melamine-coated pvc with steel finish (opt.407)

**on request:** height 13 cm, melamine-coated pvc with satin aluminium finish (opt.405), white finish (opt.001)  
height 13 cm, smooth aluminium with brill finish (opt.412), aluminium titanium oxidized finish (opt.414), [see surcharges on page 14](#)  
height 13 cm, aluminium with matt powder coating in the following colours, [see surcharges on page 15](#)

# jey feel

cod. **K24**

ante finitura real touch  
doors with real touch finish

 *colori in pronta consegna*  
*available colours*

**SP. 22 MM TH.22 MM**



rovere silver (opz.5306)  
silver oak (opt.5306)



rovere diamond (opz.5307)  
diamond oak (opt.5307)

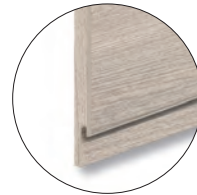
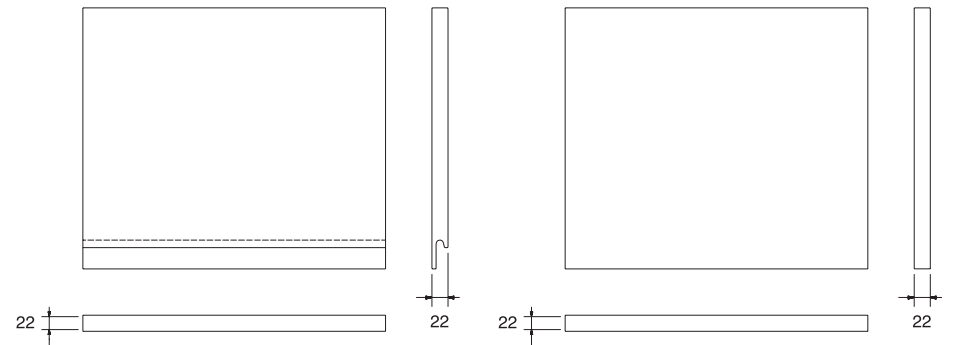

profilo anta tipo "A"  
presa maniglia  
door profile type "A"  
handle grip



profilo anta tipo "C"  
pensili apertura con presa su fondo  
door profile type "C"  
wall units opening with grip on the bottom

**A RICHIESTA SOLO PER PENSILI**  
ON REQUEST ONLY FOR WALL UNITS

ante finitura materica fiamma verticale  
doors with textured finish vertical flame

 *colori in pronta consegna*  
*available colours*



rovere tabià (opz.5309)  
tabià oak (opt.5309)



rovere ortisei (opz.5305)  
ortisei oak (opt.5305)



profilo anta tipo "A"  
presa maniglia  
door profile type "A"  
handle grip



**A RICHIESTA SOLO PER PENSILI**  
ON REQUEST ONLY FOR WALL UNITS

profilo anta tipo "C"  
pensili apertura con presa su fondo  
door profile type "C"  
wall units opening with grip on the bottom

# jey feel

cod. **K24**

ante finitura stone  
doors with stone finish

 *colori in pronta consegna  
available colours*

**SP. 22 MM TH.22 MM**



black (opz.7863)  
black (opt.7863)



white (opz.7448)  
white (opt.7448)

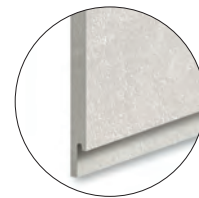
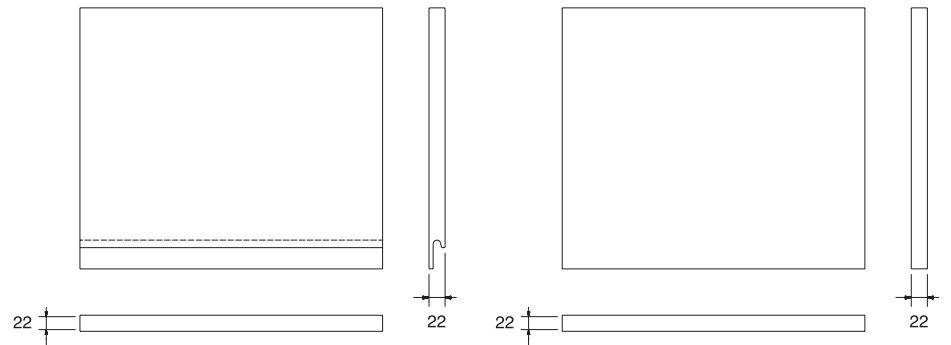

profilo anta tipo "A"  
presa maniglia  
door profile type "A"  
handle grip



**A RICHIESTA SOLO PER PENSILI**  
ON REQUEST ONLY FOR WALL UNITS

profilo anta tipo "C"  
pensili apertura con presa su fondo  
door profile type "C"  
wall units opening with grip on the bottom

anta finitura opaca marmorizzata  
door with matt marble effect finish

 *colori in pronta consegna  
available colours*



trani (opz.7704)  
trani (opt.7704)

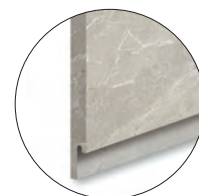

profilo anta tipo "A"  
presa maniglia  
door profile type "A"  
handle grip

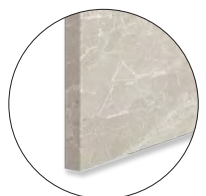

**A RICHIESTA SOLO PER PENSILI**  
ON REQUEST ONLY FOR WALL UNITS

profilo anta tipo "C"  
pensili apertura con presa su fondo  
door profile type "C"  
wall units opening with grip on the bottom

# jey feel

cod. **K24**

ante finitura top matt  
doors with top matt finish

 *colori in pronta consegna*  
*available colours*

**SP. 22 MM TH.22 MM**



grigio agata (opz.9623)  
agata grey (opt.9623)



bianco assoluto (opz.7441)  
absolute white (opt.7441)

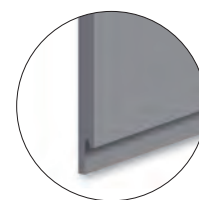
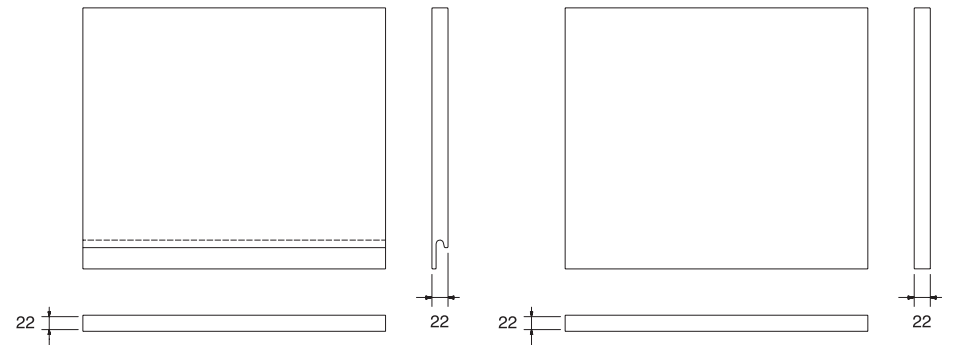

profilo anta tipo "A"  
presa maniglia  
door profile type "A"  
handle grip

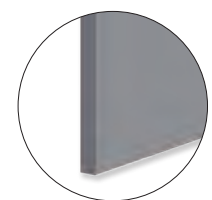

**A RICHIESTA SOLO PER PENSILI**  
ON REQUEST ONLY FOR WALL UNITS

profilo anta tipo "C"  
pensili apertura con presa su fondo  
door profile type "C"  
wall units opening with grip on the bottom

ante finitura ovatta  
doors with wadding finish

 *colori in pronta consegna*  
*available colours*



grigio inox (opz.9624)  
stainless steel grey (opt.9624)



rosso cardinale (opz.8123)  
cardinal red (opt.8123)

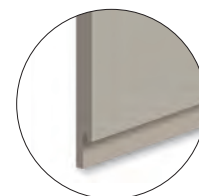

profilo anta tipo "A"  
presa maniglia  
door profile type "A"  
handle grip

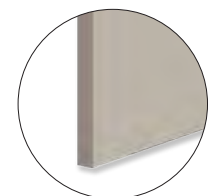

**A RICHIESTA SOLO PER PENSILI**  
ON REQUEST ONLY FOR WALL UNITS

profilo anta tipo "C"  
pensili apertura con presa su fondo  
door profile type "C"  
wall units opening with grip on the bottom

# jey feel

cod. **K24**

ante vetro in alluminio  
aluminium glass doors

SP. 22 MM TH.22 MM

ANTE VERO  
GLASS DOORS



telaio brill con vetro satinato (opz.BRSJ)  
brill frame with satin glass (opt.BRSJ)

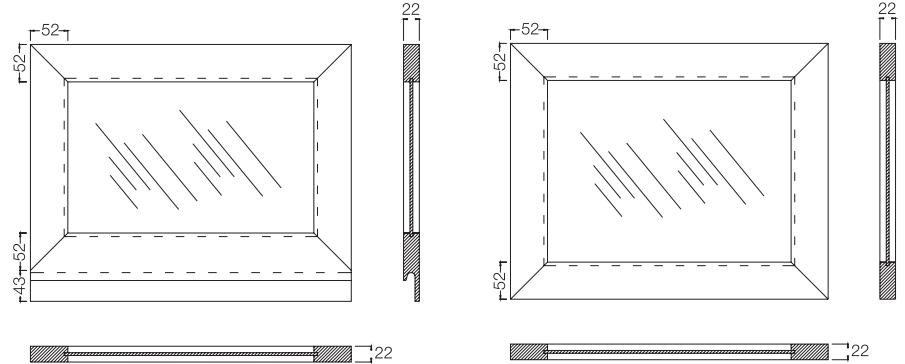

profilo anta tipo "A"  
presa maniglia  
door profile type "A"  
handle grip



**A RICHIESTA SOLO PER PENSILI**  
ON REQUEST ONLY FOR WALL UNITS

profilo anta tipo "C"  
pensili apertura con presa su fondo  
door profile type "C"  
wall units opening with grip on the bottom



telaio selce con vetro bronzo (opz.SEBJ)  
flint frame with bronze glass (opt.SEBJ)



telaio silver dark con vetro satinato (opz.DASJ)  
dark silver frame with satin glass (opt.DASJ)

# jey feel

## strutture carcasses



bianco (opz.001)  
schiena e ripiano bianco (opz.001)  
white (opt.001)  
white back panel and shelf (opt.001)



conchiglia (opz.8910)  
schiena e ripiano conchiglia (opz.8910)  
shell (opt.8910)  
shell back panel and shelf (opt.8910)



argilla (opz.9690)  
schiena e ripiano argilla (opz.9690)  
clay (opt.9690)  
clay back panel and shelf (opt.9690)



visone (opz.948M)  
schiena e ripiano visone (opz.948M)  
mink (opt.948M)  
mink back panel and shelf (opt.948M)



fango (opz.8860)  
schiena e ripiano fango (opz.8860)  
mud (opt.8860)  
mud back panel and shelf (opt.8860)



lavagna (opz.9620)  
schiena e ripiano lavagna (opz.9620)  
slate grey (opt.9620)  
slate grey back panel and shelf (opt.9620)



### CREO ECOLOGIC

IL GRUPPO LUBE HA SCELTO DI UTILIZZARE PER I COMPONENTI COSTITUENTI LE STRUTTURE DELLE CUCINE SOLO MATERIALE A BASSISSIME EMISSIONI DI FORMALDEIDE: CONFORMI ALLO STANDARD F★★★★ SECONDO LA NORMA JIS, CERTIFICATO DAL MINISTERO GIAPPONESE, IL PIÙ SEVERO IN MERITO ALLE NORMATIVE DI SALVAGUARDIA AMBIENTALE.

LUBE GROUP HAS CHOSEN TO EXCLUSIVELY USE MATERIALS WITH VERY LOW FORMALDEHYDE EMISSIONS FOR THE COMPONENTS MAKING UP THE KITCHEN CARCASSES: THESE ELEMENTS COMPLY WITH THE F4 STAR STANDARD ACCORDING TO JIS, CERTIFIED BY THE JAPANESE GOVERNMENT - THE MOST STRINGENT WHEN IT COMES TO ENVIRONMENTAL PROTECTION.

## zoccoli in pvc H 13

### pvc plinths H 13

di serie  
standard



acciaio (opz.407)  
steel (opt.407)



alluminio satinato (opz.405)  
satin aluminium (opt.405)



bianco (opz.001)  
white (opt.001)

## zoccoli in alluminio H 13

### aluminium plinths H 13

magg. rispetto allo zoccolo standard  
surcharges compared to standard plinth



alluminio liscio finitura brill (opz.412)  
smooth aluminium with brill finish (opt.412)



alluminio finitura titanio ossidato (opz.414)  
aluminium titanium oxidized finish (opt.414)

al ml per lm cod.092155 code **+20€**

per terminale "A" DX for end unit "A" RH cod.092265 code **+31€**

per terminale "A" SX for end unit "A" LH cod.092266 code **+31€**

# jey feel

zoccoli in alluminio H 13 verniciati a polvere finitura opaca  
aluminum plinths H 13 powder coated matt finish



alluminio finitura bianco assoluto (opz.740S)  
aluminium absolute white finish (opt.740S)



alluminio finitura conchiglia (opz.7403)  
aluminium shell finish (opt.7403)



alluminio finitura ghisa (opz.9509)  
aluminium cast iron finish (opt.9509)

abbinamento consigliato:  
recommended combinations

Bianco Assoluto  
absolute white  
Rovere Diamond  
diamond oak  
Stone White  
white stone

abbinamento consigliato:  
recommended combinations

Rovere Ortisei  
ortisei oak  
Marmorizzato Trani  
trani marble

abbinamento consigliato:  
recommended combinations

Rovere Tabià  
tabià oak

magg. rispetto allo zoccolo standard  
surcharges compared to standard plinth

al ml per lm cod.092125 +35 €  
code

angolare cod.0923933 +4 €  
angular code



alluminio finitura silver dark (opz.9507)  
aluminium dark silver finish (opt.9507)



alluminio finitura grigio selce (opz.SE)  
aluminium flint grey finish (opt.SE)

abbinamento consigliato:  
recommended combinations

Stone Black  
black stone  
Grigio Agata  
agata grey  
Rovere Silver  
silver oak

abbinamento consigliato:  
recommended combinations

Grigio Inox  
stainless steel grey  
Rovere Silver  
silver oak

## mensole in laminato laminate shelves

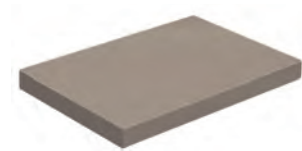

visone (opz.948M)  
mink (opt.948M)



bianco (opz.001)  
white (opt.001)

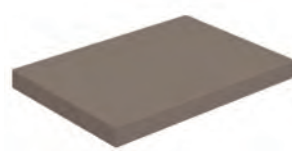

fango (opz.8860)  
mud (opt.8860)

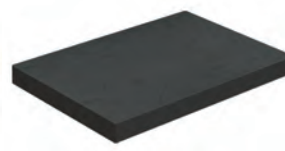

lavagna (opz.9620)  
slate grey (opt.9620)

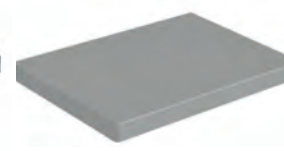

argilla (opz.9690)  
clay (opt.9690)



conchiglia (opz.8910)  
shell (opt.8910)

## mensole in laminato colore come ante laminate shelves same colour as doors



colori come ante  
colours same as doors



# MODULARITÀ E COMPONIBILITÀ MODULARITY AND FITTING SOLUTIONS

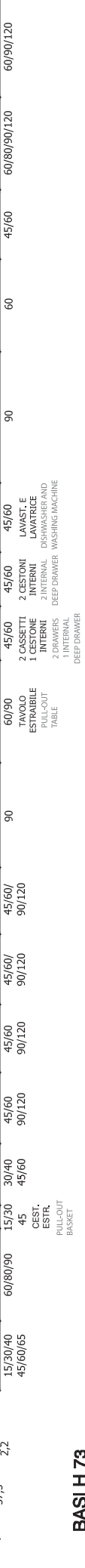
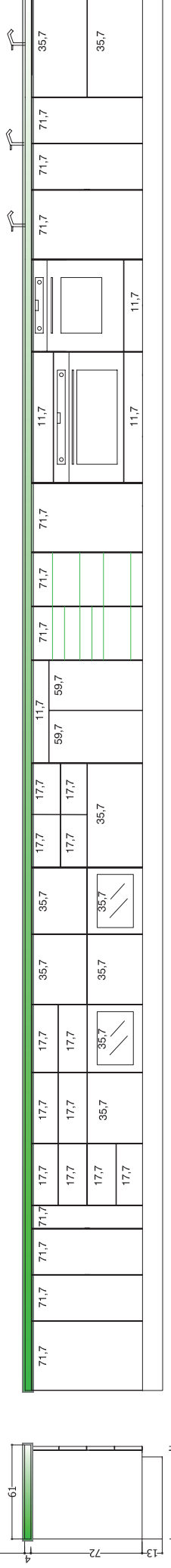
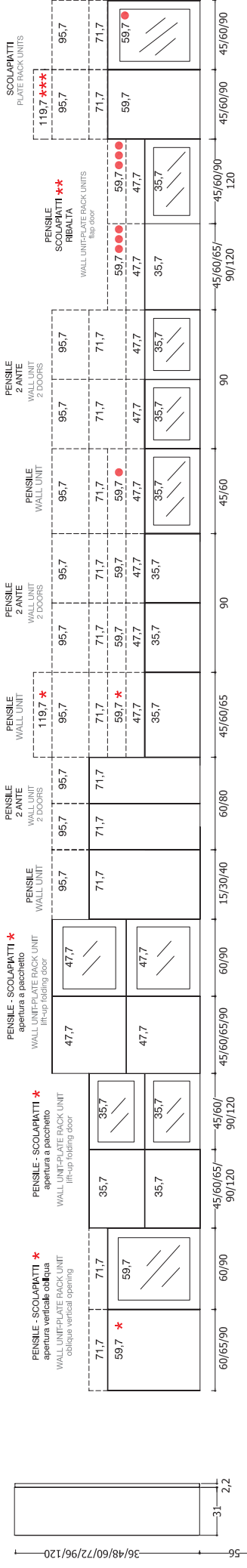

**BASI H 73**  
BASE UNITS H 73

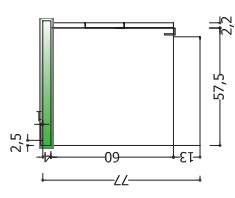

**BASI LIVING CON PIEDINO H 13**  
ROOM UNITS WITH FEET H 13

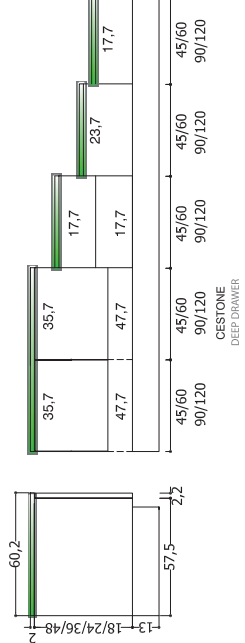

**BASI SOSPESE LIVING**  
HANGING LIVING BASE UNITS

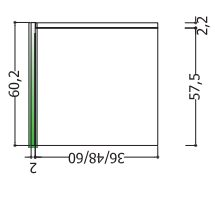

**BASI LIVING CON PIEDINO H 2,5**  
ROOM UNITS WITH FEET H 2,5

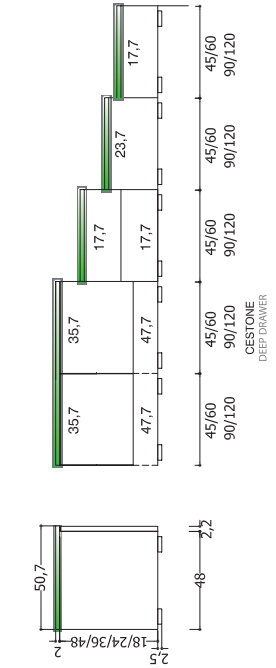

*	ESCLUSO 65 EXCLUDING 65	●	SOLO 60 ONLY 60
**	ESCLUSO 45 EXCLUDING 45	●	SOLO 45 ONLY 45
***	ESCLUSO 90 EXCLUDING 90	●	SOLO 60/90 ONLY 60/90

# MODULARITÀ E COMPONIBILITÀ MODULARITY AND FITTING SOLUTIONS



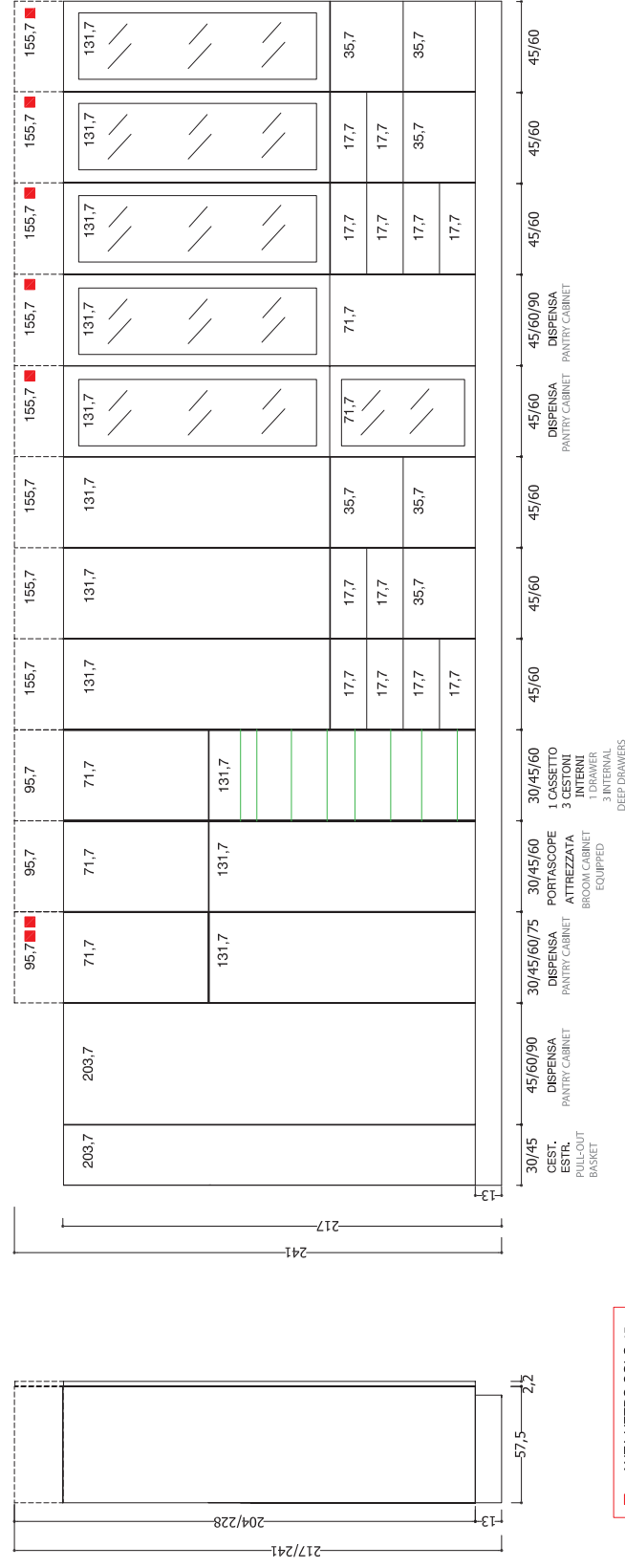
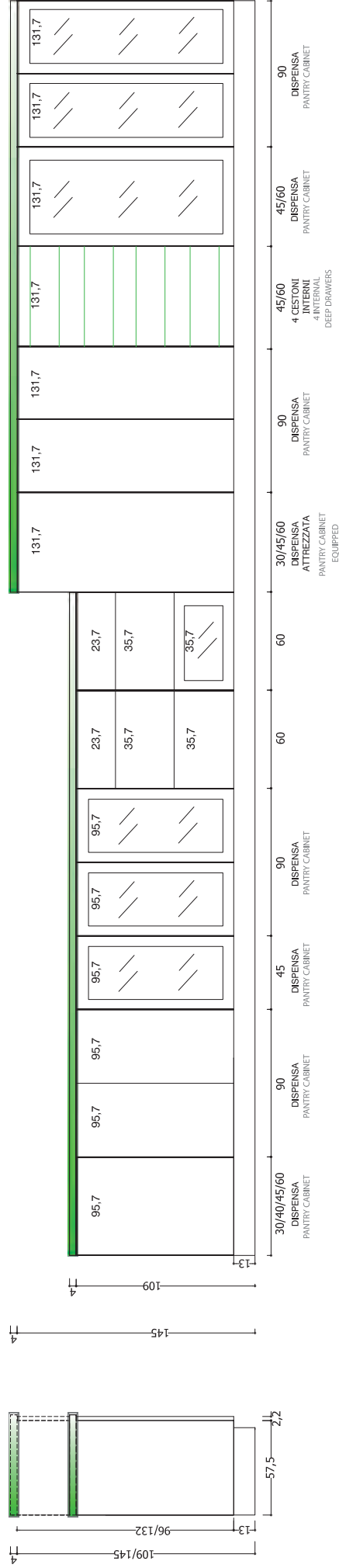



COLONNE  
COLUMNS

























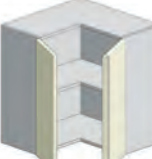
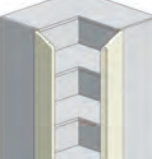
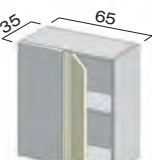
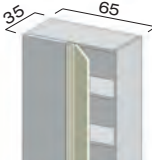

		COD.	JEY K24				
 <p><b>2 ante H 36</b> 2 doors H 36</p>							
	L 90	E2030900	160				
 <p><b>2 ante H 48</b> 2 doors H 48</p>							
	L 90	E2040900	190				
 <p><b>2 ante H 60</b> 2 doors H 60</p>							
	L 90	E2060900	202				
 <p><b>2 ante H 72</b> 2 doors H 72</p>							
	L 60	E2010600	191				
	L 80	E2010800	209				
	L 90	E2010900	216				
 <p><b>2 ante H 96</b> 2 doors H 96</p>							
	L 60	E2020600	235				
	L 80	E2020800	259				
	L 90	E2020900	270				
 <p><b>cestello estraibile chiusura soft</b> pull-out basket unit soft-closing system</p>							
	H 72 L 15	E2010150	157				
	H 96 L 15	E2020150	189				
 <p><b>fascia tamponamento L da 3 a 15</b> filler panel size from 3 to 15</p>							
	H 60	E2790000	76				
	H 72	E2800000	76				
	H 96	E2810000	87				

		COD.	JEY K24				
 <p><b>1 anta vetro H 48</b> 1 glass door H 48</p>							
	L 45	E1042451/2	246				
	L 60	E1042601/2	262				
 <p><b>1 anta vetro H 60</b> 1 glass door H 60</p>							
	L 60	E1062601/2	283				
 <p><b>1 anta vetro H 72</b> 1 glass door H 72</p>							
	L 45	E1012451/2	270				
	L 60	E1012601/2	299				
 <p><b>1 anta vetro H 96</b> 1 glass door H 96</p>							
	L 45	E1022451/2	317				
	L 60	E1022601/2	367				

	COD.	JEY K24				
<p><b>2 ante vetro H 48</b> 2 glass doors H 48</p> 						
L 90	E1042900	448				
<p><b>2 ante vetro H 72</b> 2 glass doors H 72</p> 						
L 90	E1012900	501				
<p><b>2 ante vetro H 96</b> 2 glass doors H 96</p> 						
L 90	E1022900	581				
<p><b>terminale H 72 31x31 a giorno tipo "A"</b> open end unit H 72 31x31 type "A"</p>  <p>H 72</p>						
colore come struttura same colour as carcass						
H 72	E2620310	92				
<p><b>terminale H 96 31x31 a giorno tipo "A"</b> open end unit H 96 31x31 type "A"</p>  <p>H 96</p>						
colore come struttura same colour as carcass						
H 96	E2630310	118				



		COD.	JEY K24				
 <p><b>angolo H 72</b> <b>1 anta diagonale</b> corner unit H 72 1 diagonal door</p>							
	65X65	E2400651/2	206				
 <p><b>angolo H 96</b> <b>1 anta diagonale</b> corner unit H 96 1 diagonal door</p>							
	65X65	E2410651/2	250				
 <p><b>angolo H 72</b> <b>2 ante</b> <b>anta sx+dx con angolare</b> <b>N.B.: non si effettuano fuori squadra</b> corner unit H 72 2 doors LH+RH door with angular Note: out-of-plumb units unavailable</p>							
	65X65	E2430650	357				
 <p><b>angolo H 96</b> <b>2 ante</b> <b>anta sx+dx con angolare</b> <b>N.B.: non si effettuano fuori squadra</b> corner unit H 96 2 doors LH+RH door with angular Note: out-of-plumb units unavailable</p>							
	65X65	E2440650	415				
 <p><b>angolo H 72</b> <b>1 anta</b> <b>N.B.: fuori squadra realizzabili da 88° a 94°</b> corner unit H 72 1 door Note: out-of-plumb units available from 88° to 94°</p> <p>verso dx RH version</p>							
	65X35	E2491651/2	285				
 <p><b>angolo H 96</b> <b>1 anta</b> <b>N.B.: fuori squadra realizzabili da 88° a 94°</b> corner unit H 96 1 door Note: out-of-plumb units available from 88° to 94°</p> <p>verso dx RH version</p>							
	65X35	E2495651/2	347				

		COD.	JEY K24				
 <p><b>copriboiler H 72</b> <b>1 anta</b> boiler housing H 72 1 door</p>	L 60 P 33,4	E2150601/2	137				
	L 65	E2150651/2	141				
	L 60 P 47,4	E2160601/2	192				
	L 65	E2160651/2	196				
	L 60 P 59,9	E2170601/2	192				
	L 65	E2170651/2	196				
 <p><b>copriboiler H 96</b> <b>1 anta</b> boiler housing H 96 1 door</p>	L 60 P 33,4	E2210601/2	162				
	L 65	E2210651/2	167				
	L 60 P 47,4	E2220601/2	225				
	L 65	E2220651/2	229				
	L 60 P 59,9	E2230601/2	225				
	L 65	E2230651/2	229				
 <p><b>jolly pensile H 36</b> <b>L da 10 a 30</b> jolly wall unit H 36 size from 10 to 30</p>							
	colore come struttura same colour as carcass	E2703600	95				
	colore come anta same colour as door	E2703630	145				
 <p><b>jolly pensile H 48</b> <b>L da 10 a 30</b> jolly wall unit H 48 size from 10 to 30</p>							
	colore come struttura same colour as carcass	E2704800	114				
	colore come anta same colour as door	E2704830	171				
 <p><b>jolly pensile H 60</b> <b>L da 10 a 30</b> jolly wall unit H 60 size from 10 to 30</p>							
	colore come struttura same colour as carcass	E2706000	117				
	colore come anta same colour as door	E2706030	183				
 <p><b>jolly pensile H 72</b> <b>L da 10 a 30</b> jolly wall unit H 72 size from 10 to 30</p>							
	colore come struttura same colour as carcass	E2700000	128				
	colore come anta same colour as door	E2700030	198				
 <p><b>jolly pensile H 96</b> <b>L da 10 a 30</b> jolly wall unit H 96 size from 10 to 30</p>							
	colore come struttura same colour as carcass	E2710000	153				
	colore come anta same colour as door	E2710030	238				

# PENSILI RIBALTA CHIUSURA AMMORTIZZATA

FLAP DOOR WALL UNITS BLUMOTION CLOSING SYSTEM

## PENSILE CON APERTURA A RIBALTA





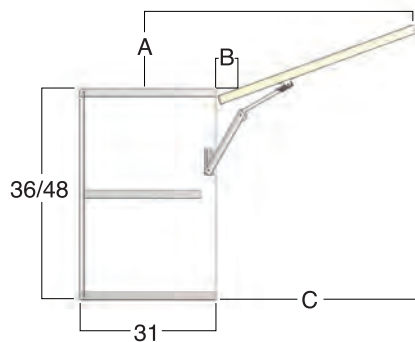

Le ante aprendosi verso l'alto consentono di avere un' ampia visione d'insieme all'interno del mobile. In questo modo è possibile un comodo accesso agli oggetti contenuti al suo interno e, dal punto di vista ergonomico, molto vantaggioso. La regolazione della forza di apertura può essere impostata in modo esatto in base al peso del frontale. Grazie all'arresto progressivo le ante si fermano in qualsiasi posizione; in questo modo la maniglia è sempre facilmente raggiungibile. La chiusura è ammortizzata di serie.

### WALL UNIT WITH FLAP DOOR

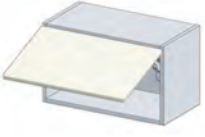

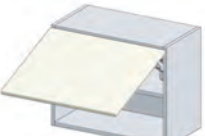
The doors that open upwards guarantee ample overall visibility inside the cabinet. In this way, all objects housed inside the cabinet can be comfortably accessed, making the system highly advantageous from an ergonomic perspective. The opening force can be adjusted precisely according to the weight of the front. The doors stop in any position thanks to the gradual stopping movement; in this way, the handle is always easily accessible. The closing movement is cushioned standard



	A	B	C
H 36	7	4	37
H 48	11	4	49

		COD.	JEY K24				
 <p><b>anta ribalta H 36</b> flap door H 36</p>	L 45	E2100450	120				
	L 60	E2100600	133				
	L 65	E2100650	148				
	L 90	E2100900	163				
	L 120	E2101200	211				
 <p><b>anta ribalta H 48</b> flap door H 48</p>	L 45	E2120450	147				
	L 60	E2120600	159				
	L 65	E2120650	163				
	L 90	E2120900	181				
	L 120	E212120C	278				
 <p><b>anta ribalta H 60</b> flap door H 60</p>	L 60	E212560C	220				
	L 90	E212590C	279				
 <p><b>anta vetro ribalta H 36</b> glass flap door H 36</p>	L 45	E1102450	234				
	L 60	E1102600	257				
	L 90	E1102900	322				
	L 120	E1103200	428				
 <p><b>anta vetro ribalta H 48</b> glass flap door H 48</p>	L 45	E1122450	259				
	L 60	E1122600	293				
	L 90	E1122900	360				
	L 120	E112320C	559				
 <p><b>anta vetro ribalta H 60</b> glass flap door H 60</p>	L 60	E1132600	431				
	L 90	E1132900	539				

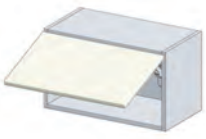
**N.B.: disponibile solo con anta squadrata profilo tipo "C"**  
 Note: only available with square door with type "C" profile

		COD.	JEY K24				
 <p><b>anta ribalta TIP-ON H 36</b> flap door TIP-ON H 36</p>	L 45	E210046T	120				
	L 60	E210061T	133				
	L 65	E210066T	148				
	L 90	E210091T	163				
	L 120	E210121T	211				
 <p><b>anta ribalta TIP-ON H 48</b> flap door TIP-ON H 48</p>	L 45	E212046T	147				
	L 60	E212061T	159				
	L 65	E212066T	163				
	L 90	E212091T	181				
	L 120	E212121T	278				
 <p><b>anta ribalta TIP-ON H 60</b> flap door TIP-ON H 60</p>	L 60	E212561T	220				
	L 90	E212591T	279				

**APERTURA VERTICALE OBLIQUA**

I pensili con questo tipo di meccanismo necessitano per l'apertura di poco spazio libero sopra il mobile grazie al movimento basculante dell'anta che si apre senza difficoltà applicando poca forza anche in presenza di frontali pesanti. Con l'arresto progressivo le ante si fermano in qualsiasi posizione; in questo modo la maniglia è sempre facilmente raggiungibile. La chiusura è ammortizzata ed è possibile regolare la forza di tenuta in base al peso del frontale.

VERTICAL OPENING OBLIQUE

Wall units that mount this type of mechanism require little clearance above the cabinet thanks to the swivelling movement of the door that can be easily opened by applying slight pressure, even with heavy fronts. The doors stop in any position thanks to the gradual stopping movement; in this way, the handle is always easily accessible. The closing movement is cushioned and the closing force can be adjusted according to the weight of the front door.

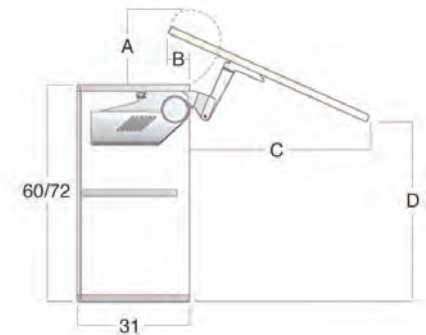

	A	B	C	D
H 60	18	9,6	46,5	53,5
H 72	18	9,6	57	61

**PENSILE CON APERTURA ANTE A PACCHETTO**

Il meccanismo d'apertura ante a pacchetto è idoneo sia sul pensile H 72 che H 96; la regolazione della forza di apertura può essere impostata in modo esatto in base ai pesi dei frontali, la chiusura è ammortizzata e la cerniera centrale clip si contraddistingue per l'innovativa tecnologia che garantisce la sicurezza per le dita.

WALL UNIT WITH LIFT-UP FOLDING DOORS

The lift-up folding door opening mechanism is suitable for wall units with H 72 or H 96; the opening force can be adjusted precisely according to the weight of the fronts, while the closing movement is cushioned and the central clip-on hinge features innovative technology for safeguarding the fingers.

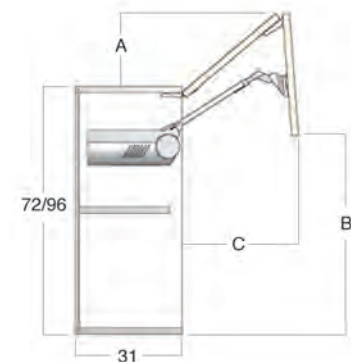



	A	B	C
H 72	16,5	54	41
H 96	20	69	53

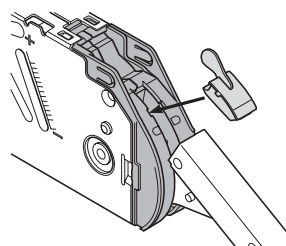
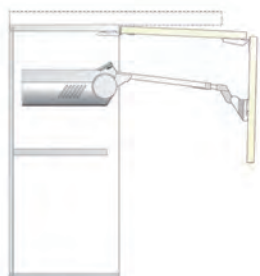



**SCHEMA MONTAGGIO LIMITATORE**  
LIMITER INSTALLATION DIAGRAM

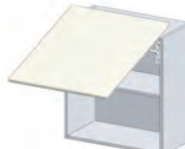
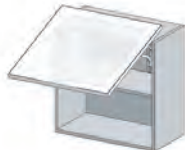

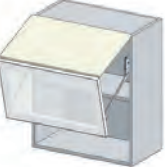

Per evitare l'interferenza dell'anta in fase di apertura con cornici o mensole, si può richiedere il limitatore dell'angolo di apertura cod. 5620005 € 10

In order to avoid that the door interferes with cornices or shelves during the opening movement, it is possible to request an opening angle limiter: code 5620005 € 10





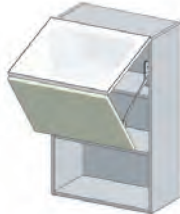

	COD.	JEY K24				
<p><b>anta apertura verticale obliqua H 60</b> door with oblique vertical opening H 60</p> 						
	L 60 E2135600	308				
	L 90 E2135900	337				
<p><b>anta apertura verticale obliqua H 72</b> door with oblique vertical opening H 72</p> 						
	L 60 E2130600	323				
	L 65 E2130650	337				
	L 90 E2130900	352				
<p><b>anta vetro apertura verticale obliqua H 60</b> glass door with oblique vertical opening H 60</p> 						
	L 60 E1207600	445				
	L 90 E1207900	515				
<p><b>anta vetro apertura verticale obliqua H 72</b> glass door with oblique vertical opening H 72</p> 						
	L 60 E1202600	467				
	L 90 E1202900	539				

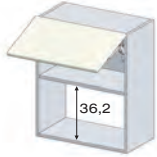
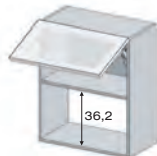
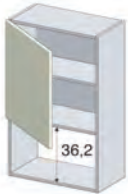
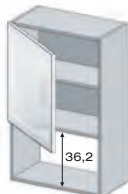





		COD.	JEY K24				
 <p><b>pensile H 72 apertura a pacchetto 2 ante H 36</b> wall unit H 72 lift-up folding door 2 doors H 36</p>	L 45	E2070450	309				
	L 60	E2070600	321				
	L 65	E2070650	340				
	L 90	E2070900	353				
	L 120	E2071200	460				
	 <p><b>pensile H 72 apertura a pacchetto 2 ante vetro H 36</b> wall unit H 72 lift-up folding door 2 glass doors H 36</p>	L 45	E1075450	545			
L 60		E1075600	584				
L 90		E1075900	676				
L 120		E1076200	890				
 <p><b>pensile H 72 apertura a pacchetto 1 anta chiusa superiore H 36 1 anta vetro inferiore H 36</b> wall unit H 72 lift-up folding door 1 full upper door H 36 1 glass lower door H 36</p>		L 45	E2085450	425			
	L 60	E2085600	452				
	L 90	E2085900	516				
	L 120	E2086200	684				
	 <p><b>pensile H 72 apertura a pacchetto 1 anta vetro superiore H 36 1 anta chiusa inferiore H 36</b> wall unit H 72 lift-up folding door 1 glass upper door H 36 1 full lower door H 36</p>	L 45	E2087450	424			
L 60		E2087600	447				
L 90		E2087900	509				
L 120		E2088200	667				













		COD.	JEY K24				
 <p><b>pensile H 96 apertura a pacchetto 2 ante H 48</b> wall unit H 96 lift-up folding door 2 doors H 48</p>	L 45	E2090450	347				
	L 60	E2090600	362				
	L 65	E2090650	383				
	L 90	E2090900	402				
 <p><b>pensile H 96 apertura a pacchetto 2 ante vetro H 48</b> wall unit H 96 lift-up folding door 2 glass doors H 48</p>	L 60	E1095600	637				
	L 90	E1095900	757				
 <p><b>pensile H 96 apertura a pacchetto 1 anta chiusa superiore H 48 1 anta vetro inferiore H 48</b> wall unit H 96 lift-up folding door 1 full upper door H 48 1 glass lower door H 48</p>	L 60	E2097600	498				
	L 90	E2097900	587				
 <p><b>pensile H 96 apertura a pacchetto 1 anta vetro superiore H 48 1 anta chiusa inferiore H 48</b> wall unit H 96 lift-up folding door 1 glass upper door H 48 1 full lower door H 48</p>	L 60	E2098600	488				
	L 90	E2098900	563				



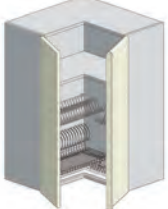

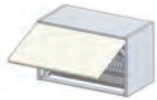
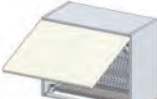
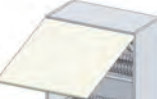
	COD.	JEY K24				
<p><b>pensile H 72</b> <b>1 anta ribalta H 36</b> <b>vano per micro Whirlpool</b> wall unit H 72 1 flap door H 36 housing for Whirlpool microwave</p> 						
<b>L 60</b>	EPM20600	164				
<p><b>pensile H 72</b> <b>1 anta vetro ribalta H 36</b> <b>vano per micro Whirlpool</b> wall unit H 72 1 glass flap door H 36 housing for Whirlpool microwave</p> 						
<b>L 60</b>	EPM11600	287				
<p><b>pensile H 96</b> <b>1 anta H 60</b> <b>vano per micro Whirlpool</b> wall unit H 96 1 door H 60 housing for Whirlpool microwave</p> 						
<b>L 60</b>	EPM25601/2	167				
<p><b>pensile H 96</b> <b>1 anta vetro H 60</b> <b>vano per micro Whirlpool</b> wall unit H 96 1 glass door H 60 housing for Whirlpool microwave</p> 						
<b>L 60</b>	EPM16601/2	316				



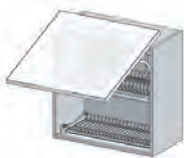

		COD.	JEY K24				
 <p><b>soprapensile H 36</b> <b>1 anta</b> top unit H 36 1 door</p>	L 45	E2063451/2	147				
	L 60	E2063601/2	161				
 <p><b>soprapensile H 48</b> <b>1 anta</b> top unit H 48 1 door</p>	L 45	E2064451/2	175				
	L 60	E2064601/2	191				
 <p><b>soprapensile H 60</b> <b>1 anta</b> top unit H 60 1 door</p>	L 45	E2065451/2	190				
	L 60	E2065601/2	208				
 <p><b>soprapensile H 36</b> <b>2 ante</b> top unit H 36 2 doors</p>	L 90	E2063900	219				
 <p><b>soprapensile H 48</b> <b>2 ante</b> top unit H 48 2 doors</p>	L 90	E2064900	262				
 <p><b>soprapensile H 60</b> <b>2 ante</b> top unit H 60 2 doors</p>	L 90	E2065900	288				

		COD.	JEY K24				
 <p><b>1 anta H 60</b> 1 door H 60</p>	L 45	E3060451/2	154				
	L 60	E3060601/2	165				
 <p><b>1 anta H 72</b> 1 door H 72</p>	L 45	E3010451/2	162				
	L 60	E3010601/2	177				
 <p><b>1 anta H 96</b> 1 door H 96</p>	L 45	E3020451/2	193				
	L 60	E3020601/2	217				
 <p><b>1 anta H 120</b> 1 door H 120</p>	L 45	E3067451/2	258				
	L 60	E3067601/2	270				
 <p><b>1 anta vetro H 60</b> 1 glass door H 60</p>	L 60	E3262601/2	312				
 <p><b>1 anta vetro H 72</b> 1 glass door H 72</p>	L 45	E3212451/2	304				
	L 60	E3212601/2	333				
 <p><b>1 anta vetro H 96</b> 1 glass door H 96</p>	L 45	E3222451/2	348				
	L 60	E3222601/2	403				





	COD.	JEY K24				
 <p><b>2 ante H 60</b> 2 doors H 60</p>	L 90	E3060900	260			
 <p><b>2 ante H 72</b> 2 doors H 72</p>	L 60	E3010600	230			
	L 80	E3010800	252			
	L 90	E3010900	261			
 <p><b>2 ante H 96</b> 2 doors H 96</p>	L 60	E3020600	274			
	L 80	E3020800	302			
	L 90	E3020900	314			
 <p><b>2 ante vetro H 72</b> 2 glass doors H 72</p>	L 90	E3212900	545			
 <p><b>2 ante vetro H 96</b> 2 glass doors H 96</p>	L 90	E3222900	625			
 <p><b>angolo H 72</b> <b>2 ante</b> <b>anta sx+dx con angolare</b> <b>N.B.: non si effettuano fuori squadra</b> corner unit H 72 2 doors LH+RH door with angular Note: out-of-plumb units unavailable</p>	65X65	E3430650	539			
 <p><b>angolo H 96</b> <b>2 ante</b> <b>anta sx+dx con angolare</b> <b>N.B.: non si effettuano fuori squadra</b> corner unit H 96 2 doors LH+RH door with angular Note: out-of-plumb units unavailable</p>	65X65	E3440650	601			

		COD.	JEY K24				
 <p><b>anta ribalta H 36</b> <b>griglie orion grau e raccogliocce plastica</b> flap door H 36 orion grau grilles and plastic drip tray</p>	L 60	E3100600	158				
	L 90	E3100900	197				
	L 120	E3101205	266				
 <p><b>anta ribalta H 48</b> <b>griglie orion grau e raccogliocce plastica</b> flap door H 48 orion grau grilles and plastic drip tray</p>	L 60	E3120600	176				
	L 90	E3120900	204				
	L 120	E3121205	299				
 <p><b>anta ribalta H 60</b> <b>griglie orion grau e raccogliocce plastica</b> flap door H 60 orion grau grilles and plastic drip tray</p>	L 60	E312260C	234				
	L 90	E312290C	296				
 <p><b>anta vetro ribalta H 36</b> <b>griglie orion grau e raccogliocce plastica</b> glass flap door H 36 orion grau grilles and plastic drip tray</p>	L 60	E3132600	281				
	L 90	E3132900	353				
	L 120	E3133205	489				
 <p><b>anta vetro ribalta H 48</b> <b>griglie orion grau e raccogliocce plastica</b> glass flap door H 48 orion grau grilles and plastic drip tray</p>	L 60	E3142600	310				
	L 90	E3142900	383				
	L 120	E3143205	587				
 <p><b>anta vetro ribalta H 60</b> <b>griglie orion grau e raccogliocce plastica</b> glass flap door H 60 orion grau grilles and plastic drip tray</p>	L 60	E3152600	458				
	L 90	E3152900	557				
 <p><b>Maggiorazione</b> <b>kit luce LED DUAL COLOR calda (2700K) e naturale (4200K)</b> <b>interruttore ON/OFF "Touch" a sfioramento con alimentatore incluso</b> <b>Surcharge</b> DUAL COLOR LED light kit warm (2700K) and natural (4200K) "Soft Touch" switch ON/OFF with power supplier</p>		opz.005					
	L 45		+100				
	L 60		+105				
	L 65		+105				
	L 80		+115				
	L 90		+115				
	L 120		+135				

		COD.	JEY K24				
 <p><b>anta apertura verticale obliqua H 60 griglie orion grau e raccogliocce plastica</b> door with vertical oblique opening H 60 orion grau grilles and plastic drip tray</p>							
	L 60	E3123600	326				
	L 90	E3123900	361				
 <p><b>anta apertura verticale obliqua H 72 griglie orion grau e raccogliocce plastica</b> door with vertical oblique opening H 72 orion grau grilles and plastic drip tray</p>							
	L 60	E3125600	338				
	L 90	E3125900	371				
 <p><b>anta vetro apertura verticale obliqua H 60 griglie orion grau e raccogliocce plastica</b> glass door with vertical oblique opening H 60 orion grau grilles and plastic drip tray</p>							
	L 60	E3207600	455				
	L 90	E3207900	530				
 <p><b>anta vetro apertura verticale obliqua H 72 griglie orion grau e raccogliocce plastica</b> glass door with vertical oblique opening H 72 orion grau grilles and plastic drip tray</p>							
	L 60	E3202600	477				
	L 90	E3202900	554				
 <p><b>Maggiorazione kit luce LED DUAL COLOR calda (2700K) e naturale (4200K) interruttore ON/OFF "Touch" a sfioramento con alimentatore incluso</b> <b>Surcharge</b> DUAL COLOR LED light kit warm (2700K) and natural (4200K) "Soft Toouch" switch ON/OFF with power supplier</p>		opz.005					
	L 45		+100				
	L 60		+105				
	L 65		+105				
	L 80		+115				
	L 90		+115				
	L 120		+135				



	COD.	JEY K24				
 <p><b>scolapiatti H 72 apertura a pacchetto 2 ante H 36</b> <b>griglie orion grau e raccogliocce plastica</b> plate rack unit H 72 lift-up folding door 2 doors H 36 orion grau grilles and plastic drip tray</p>	L 45	E3081450	325			
	L 60	E3081600	334			
	L 90	E3081900	371			
	L 120	E3082205	543			
 <p><b>scolapiatti H 72 apertura a pacchetto 2 ante vetro H 36</b> <b>griglie orion grau e raccogliocce plastica</b> plate rack unit H 72 lift-up folding door 2 glass doors H 36 orion grau grilles and plastic drip tray</p>	L 45	E3275450	560			
	L 60	E3275600	599			
	L 90	E3275900	689			
	L 120	E3276205	968			
 <p><b>scolapiatti H 72 apertura a pacchetto 1 anta chiusa superiore H 36 1 anta vetro inferiore H 36</b> <b>griglie orion grau e raccogliocce plastica</b> plate rack unit H 72 lift-up folding door 1 full upper door H 36 1 glass lower door H 36 orion grau grilles and plastic drip tray</p>	L 45	E3075450	440			
	L 60	E3075600	467			
	L 90	E3075900	530			
	L 120	E3076205	768			
 <p><b>scolapiatti H 72 apertura a pacchetto 1 anta vetro superiore H 36 1 anta chiusa inferiore H 36</b> <b>griglie orion grau e raccogliocce plastica</b> plate rack unit H 72 lift-up folding door 1 glass upper door H 36 1 full lower door H 36 orion grau grilles and plastic drip tray</p>	L 45	E3077450	438			
	L 60	E3077600	462			
	L 90	E3077900	522			
	L 120	E3078205	743			



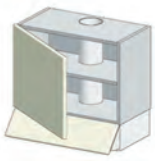
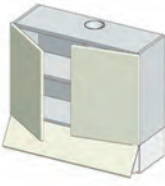
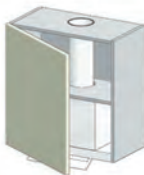
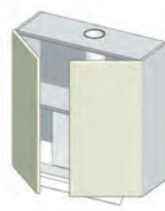

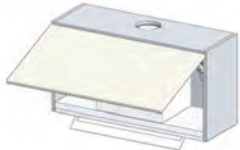
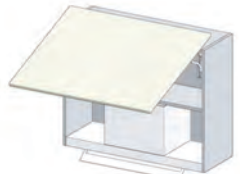
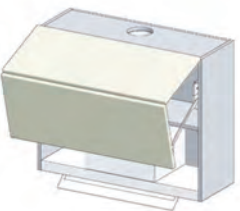



	COD.	JEY K24				
 <p><b>scolapiatti H 96 apertura a pacchetto 2 ante H 48</b> <b>griglie orion grau e raccogli gocce plastica</b> plate rack unit H 96 lift-up folding door 2 doors H 48 orion grau grilles and plastic drip tray</p>	L 45	E3094450	364			
	L 60	E3094600	375			
	L 90	E3094900	420			
 <p><b>scolapiatti H 96 apertura a pacchetto 2 ante vetro H 48</b> <b>griglie orion grau e raccogli gocce plastica</b> plate rack unit H 96 lift-up folding door 2 glass doors H 48 orion grau grilles and plastic drip tray</p>	L 60	E3295600	647			
	L 90	E3295900	771			
 <p><b>scolapiatti H 96 apertura a pacchetto 1 anta chiusa superiore H 48 1 anta vetro inferiore H 48</b> <b>griglie orion grau e raccogli gocce plastica</b> plate rack unit H 96 lift-up folding door 1 full upper door H 48 1 glass lower door H 48 orion grau grilles and plastic drip tray</p>	L 60	E3098600	508			
	L 90	E3098900	601			
 <p><b>scolapiatti H 96 apertura a pacchetto 1 anta vetro superiore H 48 1 anta chiusa inferiore H 48</b> <b>griglie orion grau e raccogli gocce plastica</b> plate rack unit H 96 lift-up folding door 1 glass upper door H 48 1 full lower door H 48 orion grau grilles and plastic drip tray</p>	L 60	E3099600	499			
	L 90	E3099900	576			
 <p><b>Maggiorazione</b> <b>kit luce LED DUAL COLOR calda (2700K) e naturale (4200K)</b> <b>interruttore ON/OFF "Touch" a sfioramento con alimentatore incluso</b> <b>Surcharge</b> DUAL COLOR LED light kit warm (2700K) and natural (4200K) "Soft Toouch" switch ON/OFF with power supplier</p>		opz.005				
	L 45		+100			
	L 60		+105			
	L 65		+105			
	L 80		+115			
	L 90		+115			
	L 120		+135			







	COD.	JEY K24				
 <p><b>cappa estraibile 2 motori portata 275 m<sup>3</sup>/h con laterali in metallo, 1 anta</b>  <b>N.B.: posizionare la cappa ad una distanza non inferiore ai 65 cm dal piano cottura</b></p> <p>slide-out hood 2 motors air flow rate 275 m<sup>3</sup>/h with metal sides, 1 door  <b>Note: position the hood at least 65 cm from the cooker hob</b></p>						
	H 63 L 60	E3600601/2	312			
	H 87 L 60	E3610601/2	339			
	n° 2 filtri carbone attivo 2 active carbon filters		+24			
 <p><b>cappa estraibile 2 motori portata 275 m<sup>3</sup>/h con laterali in metallo, 2 ante</b>  <b>N.B.: posizionare la cappa ad una distanza non inferiore ai 65 cm dal piano cottura</b></p> <p>slide-out hood 2 motors air flow rate 275 m<sup>3</sup>/h with metal sides, 2 doors  <b>Note: position the hood at least 65 cm from the cooker hob</b></p>						
	H 63 L 90	E3600900	392			
	H 87 L 90	E3610900	425			
	n° 2 filtri carbone attivo 2 active carbon filters		+24			
 <p><b>cappa "Mod. F" integrata totale con frontalino vetro estraibile portata 390 m<sup>3</sup>/h con faretti a led 1 anta</b>  <b>N.B.: posizionare la cappa ad una distanza non inferiore ai 55 cm dal piano cottura</b>  <b>N.B.: realizzabile anche con apertura senza maniglia presa sul fondo (opz.CF)</b></p> <p>"Mod. F" fully integrated hood with glass pull-out frontal panel air flow rate 390 m<sup>3</sup>/h, with led lights 1 door  <b>Note: position the hood at least 55 cm from the cooker hob</b>  <b>Note:feasible even with grip on bottom opening (opz.CF)</b></p>						
	H 60 L 60	EPC90461/2	484			
	H 72 L 60	EPC90561/2	493			
	H 96 L 60	EPC90661/2	530			
	n° 2 filtri carbone attivo 2 active carbon filters	08750894	31			
 <p><b>cappa "Mod. F" integrata totale con frontalino vetro estraibile portata 390 m<sup>3</sup>/h con faretti a led 2 ante</b>  <b>N.B.: posizionare la cappa ad una distanza non inferiore ai 55 cm dal piano cottura</b>  <b>N.B.: realizzabile anche con apertura senza maniglia presa sul fondo (opz.CF)</b></p> <p>"Mod. F" fully integrated hood with glass pull-out front panel air flow rate 390 m<sup>3</sup>/h with led lights 2 doors  <b>Note: position the hood at least 55 cm from the cooker hob</b>  <b>Note:feasible even with grip on bottom opening (opz.CF)</b></p>						
	H 60 L 90	EPC90490	571			
	H 72 L 90	EPC90590	580			
	H 96 L 90	EPC90690	631			
	n° 2 filtri carbone attivo 2 active carbon filters	08750894	31			



		COD.	JEY K24				
 <p><b>cappa “Mod. F” integrata totale con frontalino vetro estraibile portata 390 m³/h con faretti a led 1 anta apertura a ribalta</b> N.B.: posizionare la cappa ad una distanza non inferiore ai 55 cm dal piano cottura <b>N.B.: realizzabile anche con apertura senza maniglia presa sul fondo (opz.CF)</b></p> <p>“Mod. F” fully integrated hood with glass pull-out front panel air flow rate 390 m³/h with led lights 1 flap door Note: position the hood at least 55 cm from the cooker hob <b>Note:feasible even with grip on bottom opening (opz.CF)</b></p>	H 36 L 60	EPC80260	491				
	H 36 L 90	EPC80290	543				
	H 36 L 120	EPC80320	647				
	H 48 L 60	EPC80360	539				
	H 48 L 90	EPC80390	577				
	H 48 L 120	EPC80420	699				
	H 60 L 60	EPC80460	566				
	H 60 L 90	EPC80490	637				
n° 2 filtri carbone attivo 2 active carbon filters		08750894	31				
 <p><b>cappa “Mod.F” integrata totale con frontalino estraibile inox portata 390 m³/h 1 anta apertura verticale obliqua</b> N.B.: posizionare la cappa ad una distanza non inferiore ai 55 cm dal piano cottura <b>N.B.: realizzabile anche con apertura senza maniglia presa sul fondo (opz.CF)</b></p> <p>“Mod. F” fully-integrated hood with glass pull-out front panel flow rate 390 m³/h with led lights 1 door with vertical oblique opening Note: position the hood at least 55 cm from the cooker hob <b>Note:feasible even with grip on bottom opening (opz.CF)</b></p>	H 60 L 60	EPC86460	649				
	H 60 L 90	EPC86490	729				
	H 72 L 60	EPC86560	685				
	H 72 L 90	EPC86590	742				
	n° 2 filtri carbone attivo 2 active carbon filters		08750894	31			
 <p><b>cappa “Mod. F” integrata totale con frontalino vetro estraibile portata 390 m³/h con faretti a led 2 ante apertura a pacchetto</b> N.B.: posizionare la cappa ad una distanza non inferiore ai 55 cm dal piano cottura <b>N.B.: realizzabile anche con apertura senza maniglia presa sul fondo (opz.CF)</b></p> <p>“Mod. F” fully integrated hood with glass pull-out front panel air flow rate 390 m³/h with led lights 2 lift-up folding doors Note: position the hood at least 55 cm from the cooker hob <b>Note:feasible even with grip on bottom opening (opz.CF)</b></p>	H 72 L 60	EPC83560	671				
	H 72 L 90	EPC83590	730				
	H 72 L 120	EPC83620	876				
	H 96 L 60	EPC83660	711				
	H 96 L 90	EPC83690	779				
n° 2 filtri carbone attivo 2 active carbon filters		08750894	31				



	COD.	JEY				
<p><b>Maggiorazione</b> cappa "NO DRIP" incasso pensile portata 600 m<sup>3</sup>/h, per piano cottura ad induzione classe energetica A</p> <p><b>Surcharge</b> "NO DRIP" built in hood air flow rate 600 m<sup>3</sup>/h recommended for induction cooker hob energetic class A</p> 		K24				
L 60	opz.006	+559				
L 90	opz.006	+559				
L 120	opz.006	+676				
<p><b>filtro carbone attivo</b> active carbon filter</p>	08750844R	+42				
<p><b>PERCHÈ LA CAPPÀ "NO DRIP":</b> a differenza dei tradizionali piani cottura a gas dove la fiamma riscalda le superfici della cappa, nei piani cottura ad induzione i vapori condensano velocemente sulle superfici "fredde" della stessa, generando così gocce d'acqua che cadono sul p.c. sottostante. <b>LA CAPPÀ "NO DRIP" È LA SOLUZIONE A QUESTO PROBLEMA.</b></p>  <p><b>WHY THE "NO DRIP" HOOD:</b> unlike traditional gas hobs where the flame heats the surfaces of the hood, with induction hobs the vapors quickly condense on the "cold" surfaces of the hood, thus generating drops of water that fall on the hob below. THE "NO DRIP" HOOD IS THE SOLUTION TO THIS PROBLEM.</p>						

LE BASI NON SONO COMPRENSIVE DI TOP THE BASE UNITS DO NOT INCLUDE THE TOPS		COD.	JEY K24				
 <p><b>fascia tamponamento</b> filler panel</p>	L da 3 a 15 size from 3 to 15	E4800000	72				
 <p><b>jolly base</b> L da 10 a 30 jolly base unit size from 10 to 30</p>	colore come struttura same colour as carcass colore come anta same colour as door	E4700000	143				
		E4700030	209				
 <p><b>1 anta</b> 1 door</p>	L 15 L 30 L 40 L 45 L 60 L 65	E4010151/2	130				
		E4010301/2	138				
		E4010401/2	149				
		E4010451/2	154				
		E4010601/2	176				
		E4010651/2	182				
 <p><b>2 ante</b> 2 doors</p>	L 60 L 80 L 90	E4010600	223				
		E4010800	245				
		E4010900	258				
 <p><b>cestello estraibile</b> chiusura soft pull-out basket unit soft-closing system</p>	L 15 L 30 L 45	E4150150	169				
		E4150300	215				
		E4150450	234				
 <p><b>4 cassetti H 18</b> 4 drawers H 18</p>	L 30 L 40 L 45 L 60	E4101300	356				
		E4101400	367				
		E4101450	379				
		E4101600	409				

**LE BASI NON SONO COMPRENSIVE DI TOP**  
THE BASE UNITS DO NOT INCLUDE THE TOPS

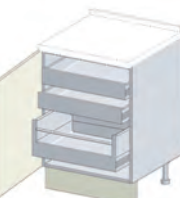
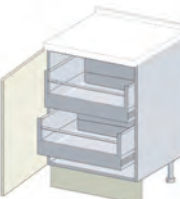
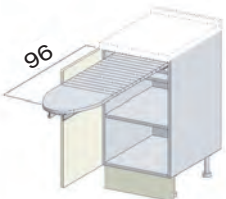
		COD.	JEY K24					
 <p><b>2 cassetti H 18</b> <b>1 cestone H 36</b> 2 drawers H 18 1 deep drawer H 36</p>	L 45	E4131450	326					
	L 60	E4131600	354					
	L 90	E4131900	412					
	L 120	E4132200	550					
 <p><b>2 cassetti H 18</b> <b>1 cestone vetro H 36</b> 2 drawers H 18 1 glass deep drawer H 36</p>	L 45	E4143450	440					
	L 60	E4143600	481					
	L 90	E4143900	568					
	L 120	E4144200	812					
 <p><b>portaposate in plastica per cassetti</b> plastic cutlery tray for drawers</p>	L 30	08700030X	10					
	L 40	08700040X	10					
	L 45	08700050X	10					
	L 60	08700060X	11					
	divisori regolabili L 90 adjustable separators	L 90	08700070X	32				
	divisori regolabili L 120 adjustable separators	L 120	08700075X	40				
 <p><b>4 cassetti H 18</b> <b>1 cestone H 36</b> 4 drawers H 18 1 deep drawer H 36</p>	L 90	E4300900	581					
 <p><b>4 cassetti H 18</b> <b>1 cestone vetro H 36</b> 4 drawers H 18 1 glass deep drawer H 36</p>	L 90	E4303900	737					
 <p><b>2 cestoni H 36</b> 2 deep drawers H 36</p>	L 45	E4171450	272					
	L 60	E4171600	298					
	L 90	E4171900	348					
	L 120	E4172200	479					

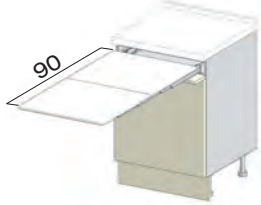
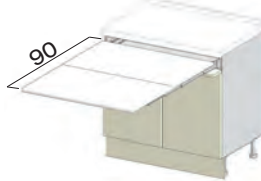
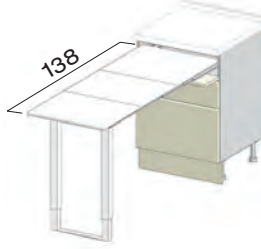
LE BASI NON SONO COMPRENSIVE DI TOP THE BASE UNITS DO NOT INCLUDE THE TOPS		COD.	JEY K24				
 <p><b>2 cestoni</b> <b>1 frontale chiuso H 36</b> <b>1 frontale vetro H 36</b> 2 deep drawers 1 full front H 36 1 glass front H 36</p>	L 45	E4183450	395				
	L 60	E4183600	434				
	L 90	E4183900	509				
	L 120	E4184200	691				
 <p><b>2 cestoni vetro H 36</b> 2 glass deep drawers H 36</p>	L 45	E4193450	507				
	L 60	E4193600	562				
	L 90	E4193900	672				
	L 120	E4194200	892				
 <p><b>1 anta</b> <b>2 cassetti interni</b> <b>1 cestone interno</b> <b>posizionare a 5 cm dalla parete laterale</b> 1 door 2 internal drawers 1 internal deep drawer <b>place at 5 cm from the side wall</b></p>	L 45	E4236461/2	355				
	L 60	E4236611/2	393				
 <p><b>1 anta</b> <b>2 cestoni interni</b> <b>posizionare a 5 cm dalla parete laterale</b> 1 door 2 internal deep drawers <b>place at 5 cm from the side wall</b></p>	L 45	E4236471/2	309				
	L 60	E4236621/2	342				
 <p><b>base asse da stiro estraibile</b> <b>1 anta H 72</b> base unit with pull-out ironing board 1 door H 72</p>	L 45	E4220451/2	726				

<b>LE BASI NON SONO COMPRENSIVE DI TOP</b> THE BASE UNITS DO NOT INCLUDE THE TOPS		COD.	JEY K24				
 <p> <b>base tavolo estraibile LUNCH</b>  <b>portata 60 kg</b>  <b>1 frontale H 12</b>  <b>1 anta H 60</b>                      base unit with pull-out table LUNCH                      load capacity kg 60                      1 front H 12                      1 door H 60                 </p>	L 60	E4232601/2	720				
 <p> <b>base tavolo estraibile LUNCH</b>  <b>portata 60 kg</b>  <b>1 frontale H 12</b>  <b>2 ante H 60</b>                      base unit with pull-out table LUNCH                      load capacity kg 60                      1 front H 12                      2 doors H 60                 </p>	L 90	E4232900	826				
 <p> <b>base tavolo estraibile PARTY</b>  <b>gamba telescopica in alluminio</b>  <b>portata 100 kg</b>  <b>1 cassetto H 18</b>  <b>1 cestone H 36</b>                      base unit with pull-out table PARTY                      telescopic legs in aluminium                      load capacity kg 100                      1 drawers H 18                      1 deep drawer H 36                 </p>	L 60	E4234600	1.279				
	L 90	E4234900	1.362				
 <p> <b>terminale a giorno tipo "A"</b>  <b>colore come struttura</b>                      open end unit type "A"                      same colour as carcass                 </p>							
	in nobilitato L 34,5 melamine coated	E4610311/2	136				



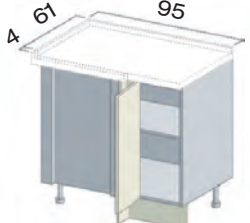
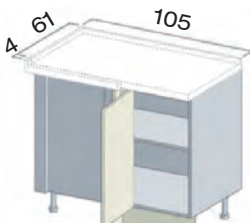
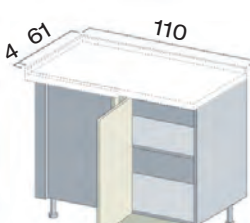
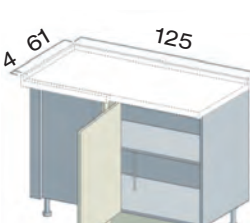
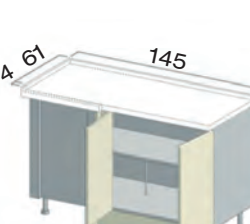
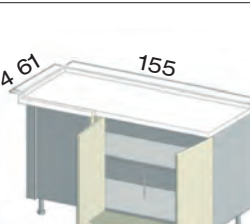

LE BASI NON SONO COMPRENSIVE DI TOP THE BASE UNITS DO NOT INCLUDE THE TOPS		COD.	JEY K24				
 <p>61 95 A</p> <p><b>angolo L 95</b> 1 ripiano 1 anta L 30 (cerniere a pilastro) cassone 90 corner unit W 95 1 shelf 1 door W 30 (pillar hinges) structure 90</p> <p>verso dx RH version</p>	95x65	E4400951/2	330				
 <p>61 105 A</p> <p><b>angolo L 105</b> 1 ripiano 1 anta L 40 (cerniere a pilastro) cassone 90 corner unit W 105 1 shelf 1 door W 40 (pillar hinges) structure 90</p> <p>verso dx RH version</p>	105x65	E4401041/2	332				
 <p>61 110 A</p> <p><b>angolo L 110</b> 1 ripiano 1 anta L 45 (cerniere a pilastro) cassone 105 corner unit W 110 1 shelf 1 door W 45 (pillar hinges) structure 105</p> <p>verso dx RH version</p>	110x65	E4401091/2	345				
 <p>61 125 A</p> <p><b>angolo L 125</b> 1 ripiano 1 anta L 60 (cerniere a pilastro) cassone 120 con tirante corner unit W 125 1 shelf 1 door W 60 (pillar hinges) structure 120 with tie beam</p> <p>verso dx RH version</p>	125x65	E4401241/2	380				
 <p>61 145 A</p> <p><b>angolo L 145</b> 1 ripiano 2 ante L 40 cassone 140 con tirante corner unit W 145 1 shelf 2 doors W 40 structure 140 with tie beam</p> <p>verso dx RH version</p>	145x65	E4401451/2	469				
 <p>61 155 A</p> <p><b>angolo L 155</b> 1 ripiano 2 ante L 45 cassone 150 con tirante corner unit W 155 1 shelf 2 doors W 45 structure 150 with tie beam</p> <p>verso dx RH version</p>	155x65	E4401551/2	478				

# BASI ANGOLO

CORNER BASE UNITS

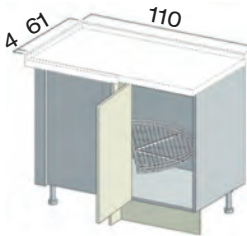
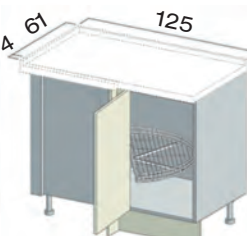
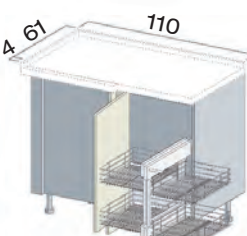
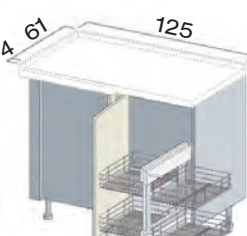
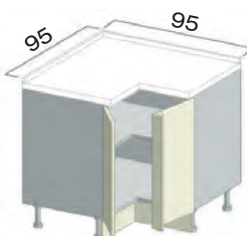
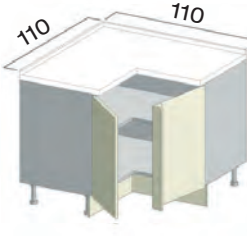
H 85 P 65

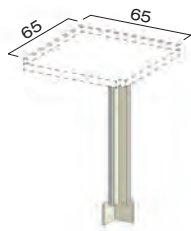
LE BASI NON SONO COMPRENSIVE DI TOP THE BASE UNITS DO NOT INCLUDE THE TOPS		COD.	JEY K24				
 <p><b>angolo L 110</b> <b>cestello mezzaluna orion grau</b> <b>1 anta L 45 (cerniere a pilastro)</b> <b>cassone 105</b> corner unit W 110 crescent-shaped orion grau wire basket unit 1 door W 45 (pillar hinges) structure 105</p> <p>verso dx RH version</p>	<p><b>1 cestello 110x65</b> 1 basket drawer</p>	E4401101/2	360				
	<p><b>2 cestelli 110x65</b> 2 basket drawers</p>	E4401111/2	396				
 <p><b>angolo L 125</b> <b>cestello mezzaluna orion grau</b> <b>1 anta L 60 (cerniere a pilastro)</b> <b>cassone 120</b> corner unit W 125 crescent-shaped orion grau wire basket unit 1 door W 60 (pillar hinges) structure 120</p> <p>verso dx RH version</p>	<p><b>1 cestello 125x65</b> 1 basket unit</p>	E4401251/2	378				
	<p><b>2 cestelli 125x65</b> 2 basket units</p>	E4401261/2	414				
 <p><b>angolo L 110</b> <b>4 cestelli orion grau estraibili indipendenti dall'anta</b> <b>1 anta L 45 (cerniere a pilastro)</b> <b>cassone 105</b> corner unit W 110 4 pull-out orion grau basket units opening independently from door 1 door W 45 (pillar hinges) structure 105</p> <p>verso dx RH version</p>							
	<p><b>110x65</b></p>	E4451101/2	859				
 <p><b>angolo L 125</b> <b>4 cestelli orion grau estraibili indipendenti dall'anta</b> <b>1 anta L 60 (cerniere a pilastro)</b> <b>cassone 120</b> corner unit W 125 4 pull-out orion grau basket units opening independently from door 1 door W 60 (pillar hinges) structure 120</p> <p>verso dx RH version</p>							
	<p><b>125x65</b></p>	E4451251/2	929				
 <p><b>angolo 95x95</b> <b>1 ripiano</b> <b>2 ante L 30 (cerniere 180°)</b> <b>angolare unito all'anta dx</b> corner unit 95x95 1 shelf 2 doors W 30 (180° hinges) angular filler attached to the RH door</p>							
	<p><b>95x95</b></p>	E4481950	588				
 <p><b>angolo 110x110</b> <b>1 ripiano</b> <b>2 ante L 45 (cerniere 180°)</b> <b>angolare unito all'anta dx</b> corner unit 110x110 1 shelf 2 doors W 45 (180° hinges) angular filler attached to the RH door</p>							
	<p><b>110x110</b></p>	E4482100	633				

LE BASI NON SONO COMPRENSIVE DI TOP THE BASE UNITS DO NOT INCLUDE THE TOPS		COD.	JEY K24				
 <p><b>angolo 65x65 con supporto</b> <b>N.B.: solo angolare</b> corner unit 65x65 with support Note: only angular filler</p>							
	65x65	E4480650	127				
 <p><b>angolo 65x65 con supporto</b> <b>per inserimento lavastoviglie destra o sinistra</b> <b>N.B.: solo angolare con fianco</b> corner unit 65x65 with support for dishwasher placed on the right or the left side Note: only angular filler with side</p> <p>verso dx RH version</p>							
	65x65	E4480651/2	170				

# BASI ANGOLO PANNELLO COME ANTA

H 85 P 61

CORNER BASE UNITS PANEL AS DOOR

**LE BASI NON SONO COMPRENSIVE DI TOP**  
THE BASE UNITS DO NOT INCLUDE THE TOPS

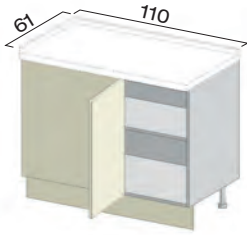
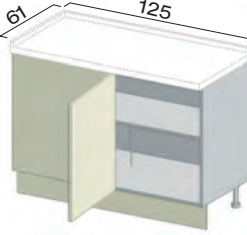
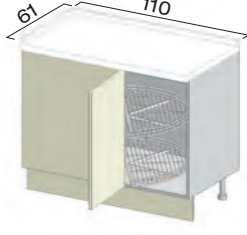
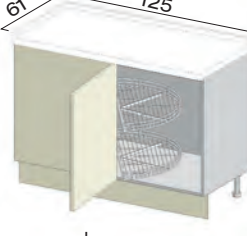
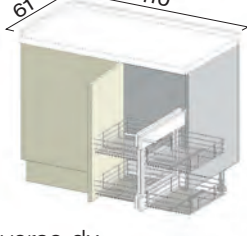
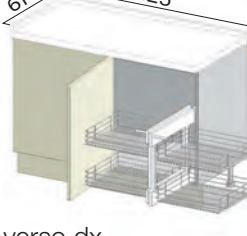
	COD.	JEY K24				
 <p><b>angolo L 110</b> <b>1 ripiano</b> <b>1 anta L 45</b> <b>pannello liscio come anta</b> <b>cassone 110</b> corner unit W 110 1 shelf 1 door W 45 panel without frame same as door structure 110</p> <p>verso dx RH version</p>	110x61	E4403091/2	295			
 <p><b>angolo L 125</b> <b>1 ripiano</b> <b>1 anta L 60</b> <b>pannello liscio come anta</b> <b>cassone 125 con tirante</b> corner unit W 125 1 shelf 1 door W 60 panel without frame same as door structure 125 with tie beam</p> <p>verso dx RH version</p>	125x61	E4403241/2	317			
 <p><b>angolo L 110</b> <b>2 cestelli mezzaluna orion grau</b> <b>1 anta L 45</b> <b>pannello liscio come anta</b> <b>cassone 110</b> corner unit W 110 2 crescent-shaped orion grau wire basket units 1 door W 45 panel without frame same as door structure 110</p> <p>verso dx RH version</p>	110x61	E4403111/2	334			
 <p><b>angolo L 125</b> <b>2 cestelli mezzaluna orion grau</b> <b>1 anta L 60</b> <b>pannello liscio come anta</b> <b>cassone 125</b> corner unit W 125 2 crescent-shaped orion grau wire basket units 1 door W 60 panel without frame same as door structure 125</p> <p>verso dx RH version</p>	125x61	E4403261/2	355			
 <p><b>angolo L 110</b> <b>4 cestelli orion grau estraibili indipendenti dall'anta</b> <b>1 anta L 45</b> <b>pannello liscio come anta</b> <b>cassone 110</b> corner unit W 110 4 pull-out orion grau basket units opening independently from door 1 door W 45 panel without frame same as door structure 110</p> <p>verso dx RH version</p>	110x61	E4453101/2	804			
 <p><b>angolo L 125</b> <b>4 cestelli orion grau estraibili indipendenti dall'anta</b> <b>1 anta L 60</b> <b>pannello liscio come anta</b> <b>cassone 125</b> corner unit W 125 4 pull-out orion grau basket units opening independently from door 1 door W 60 panel without frame same as door structure 125</p> <p>verso dx RH version</p>	125x61	E4453251/2	877			

**LE BASI NON SONO COMPRESIVE DI TOP**  
THE BASE UNITS DO NOT INCLUDE THE TOPS

COD.

**JEY**  
K24

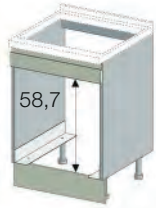

**base per forno elettrico H 60  
frontale superiore fisso H 12**  
electric oven base unit H 60  
fixed upper front H 12

L 60

E5510620

136



**base per forno elettrico H 60  
frontale inferiore fisso H 12**  
electric oven base unit H 60  
fixed lower front H 12

L 60

E5510610

136

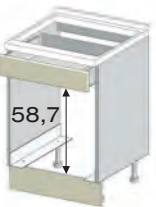

**base per forno elettrico H 60  
cassetto H 12 superiore**  
electric oven base unit H 60  
upper drawer H 12

L 60

E5510608

196

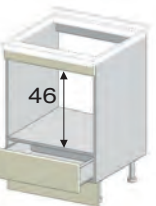

**base per forno elettrico H 46  
fascia superiore H 8,1  
cassetto H 18**  
electric oven base unit H 46  
upper filler H 8,1  
drawer H 18

L 60

E5530600

222



**base per maxiforno H 48  
frontale superiore fisso H 12  
cassetto TIP-ON H 12 inferiore**  
maxi-oven base unit H 48  
fixed upper front H 12  
lower drawer TIP-ON H 12

L 90

E5510925

266



**kit raccordo base angolo**  
junction kit for corner base unit

110x110

E5471100

171



**kit raccordo base angolo per inserimento  
lavastoviglie a destra o sinistra**  
junction kit for corner base unit for dishwasher placed on the  
right or the left side







verso dx  
RH version



110x110

E5471151/2

207

**LE BASI NON SONO COMPRENSIVE DI TOP**  
THE BASE UNITS DO NOT INCLUDE THE TOPS

		COD.	JEY K24				
 <p><b>base predisposta piano cottura 1 anta</b> base unit configured for cooker hob 1 door</p>	L 60	E5500601/2	176				
		opz.101	+55	+55			
	<p><b>mag.base piano cottura ad induzione</b> surcharge base unit for induction cooker hob</p>						
 <p><b>base predisposta piano cottura 2 ante</b> base unit configured for cooker hob 2 doors</p>	L 90	E5500900	258				
		opz.101	+55	+55			
	<p><b>mag.base piano cottura ad induzione</b> surcharge base unit for induction cooker hob</p>						
 <p><b>Maggiorazione per base predisposta piano cottura ad induzione con lamierino di protezione</b> N.B.: realizzabile su base 2 cassetti+1 cestone, base 2 cestoni e base 4 cassetti <b>Surcharge</b> for base unit configured for induction cooker hob with protection metal sheet Note: available on base unit 2 drawers+1 deep drawer, base unit 2 deep drawers and base unit 4 drawers</p>		opz.101	+55	+55			
 <p><b>base predisposta piano cottura con cappa integrata</b> <b>1 frontale superiore fisso H 18</b> <b>1 cassetto H 18 P 40</b> <b>1 cestone H 36 P 40</b> base unit configured for cooker hob with integrated hood 1 fixed upper front H 18 1 drawer H 18 D 40 1 deep drawer H 36 D 40</p>	L 90	E5509090	385				
	L 120	E5509120	570				
 <p><b>base predisposta piano cottura con cappa integrata</b> <b>1 anta vasistas H 36</b> <b>1 cestone H 36 P 40</b> base unit configured for cooker hob with integrated hood 1 flap door H 36 1 deep drawer H 36 D 40</p>	L 90	E5509095	466				
	L 120	E5509125	600				
 <p><b>Esempio di piano cottura con cappa integrata</b> Example of cooker hob with integrated hood</p>							

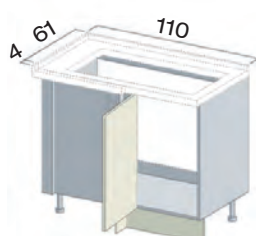
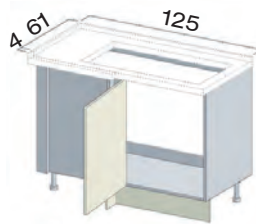
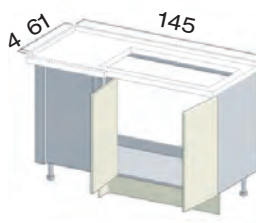
LE BASI NON SONO COMPRENSIVE DI TOP THE BASE UNITS DO NOT INCLUDE THE TOPS		COD.	JEY K24				
 <p><b>sottolavello 1 anta</b> sink base unit 1 door</p>	L 45	E5010451/2	153				
	L 60	E5010601/2	174				
 <p><b>sottolavello 2 ante</b> sink base unit 2 doors</p>	L 60	E5010600	218				
	L 80	E5010800	239				
	L 90	E5010900	247				
	L 120	E5011200	288				
 <p><b>sottolavello 2 cestoni H 36 cestone superiore sagomato con vaschette</b> sink base unit 2 deep drawers H 36 contoured upper deep drawer with trays</p>	L 60	E5200600	326				
	L 90	E5200900	385				
	L 120	E5201200	493				
 <p><b>sottolavello angolo L 110 1 anta L 45 cassone 105</b> corner sink base unit W 110 1 door W 45 structure 105</p> <p>verso dx RH version</p>	110x65	E4421101/2	329				
 <p><b>sottolavello angolo L 125 1 anta L 60 cassone 120</b> corner sink base unit W 125 1 door W 60 structure 120</p> <p>verso dx RH version</p>	125x65	E4421251/2	347				
 <p><b>sottolavello angolo L 145 2 ante L 40 cassone 140</b> corner sink base unit W 145 2 doors W 40 structure 140</p> <p>verso dx RH version</p>	145x65	E4421451/2	421				

**LE BASI NON SONO COMPRENSIVE DI TOP**  
THE BASE UNITS DO NOT INCLUDE THE TOPS

COD.

**JEY**

K24

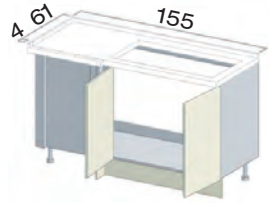

**sottolavello angolo L 155**  
**2 ante L 45**  
**cassone 150**

corner sink base unit W 155  
2 doors W 45  
structure 150

verso dx  
RH version

155x65

E4421551/2

430

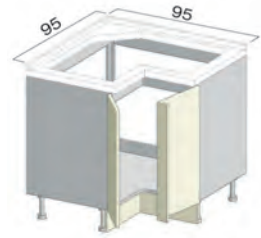

**sottolavello angolo 95x95**  
**2 ante L 30 (cerniere 180°)**  
**angolare unito all'anta dx**

corner sink base unit 95x95  
2 doors W 30 (180° hinges)  
angular filler attached to the RH door

95x95

E5021950

611

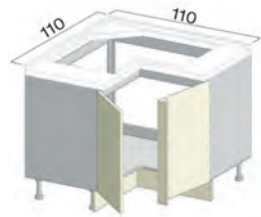

**sottolavello angolo 110x110**  
**2 ante L 45 (cerniere 180°)**  
**angolare unito all'anta dx**







corner sink base unit 110x110  
2 doors W 45 (180° hinges)  
angular filler attached to the RH door

110x110



E5022100



661





LE BASI NON SONO COMPRENSIVE DI TOP THE BASE UNITS DO NOT INCLUDE THE TOPS		COD.	JEY K24				
 <p><b>anta per lavastoviglie scomparsa totale completa di kit protezione fianchi</b> door for fully integrated dishwasher with protection kit for side panels</p>	L 45	E4490080	77				
	L 60	E4490090	94				
 <p><b>anta per lavastoviglie scomparsa totale estetica 2 cestoni completa di kit protezione fianchi</b> door for fully integrated dishwasher 2 deep drawers aesthetic with protection kit for side panels</p>	L 60	E4490100	260				
	L 45	E4490050	72				
 <p><b>anta per lavastoviglie comandi a vista completa di kit protezione fianchi</b> door for dishwasher with visible controls with protection kit for side panels</p>	L 60	E4490060	81				
	 <p><b>kit protezione fianchi per lavastoviglie</b> protection kit for side panels for dishwasher</p> 						
 <p><b>anta per lavabiancheria scomparsa totale</b> door for fully integrated washing machine</p>	L 60	E4490011/2	94				

**LE BASI NON SONO COMPRENSIVE DI TOP**  
THE BASE UNITS DO NOT INCLUDE THE TOPS

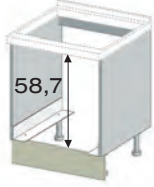



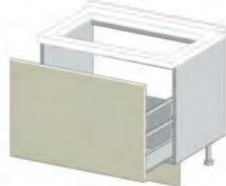

	COD.	JEY K24				
 <p><b>anta con fianco per frigo e congelatore sottotop</b> door with side panel for under-top fridge and freezer</p>						
L 60	E4490151/2	120				
 <p><b>anta per frigo e congelatore sottotop</b> door for under-top fridge and freezer</p>						
L 60	E4490181/2	94				
 <p><b>fianco per elettrodomestici a fine composizione</b> side panel for appliances placed at the end of the composition</p>						
<p><b>in nobilitato</b> melamine coated <b>H 85x60x2 zoccolo H 13</b> plinth</p>	T94613	30				
<p><b>come anta</b> as door <b>H 85x60x2,2 zoccolo H 13</b> plinth</p>	T94723	80				

LE BASI NON SONO COMPRENSIVE DI TOP THE BASE UNITS DO NOT INCLUDE THE TOPS		COD.	JEY K24				
 <p><b>base H 73 1 anta</b> base unit H 73 1 door</p>	L 45	E4030451/2	151				
	L 60	E4030601/2	168				
 <p><b>base H 73 2 ante</b> base unit H 73 2 doors</p>	L 90	E4030900	249				
	L 120	E4031200	298				
 <p><b>base H 73 2 cassetti H 18 1 cassetto H 24</b> base unit H 73 2 drawers H 18 1 drawer H 24</p>	L 45	E4250450	312				
	L 60	E4250600	337				
	L 90	E4250900	404				
	L 120	E4251200	540				
 <p><b>base H 73 predisposta per forno H 60</b> base unit H 73 configured for oven H 60</p>							
	L 60	E5540600	117				





**LE BASI NON SONO COMPRENSIVE DI TOP**  
THE BASE UNITS DO NOT INCLUDE THE TOPS

	COD.	JEY K24				
 <p><b>sottolavello H 73</b> <b>1 anta</b> sink base unit H 73 1 door</p>	L 45	E5060451/2	148			
	L 60	E5060601/2	163			
 <p><b>sottolavello H 73</b> <b>2 ante</b> sink base unit H 73 2 doors</p>	L 90	E5060900	236			
	L 120	E5061200	269			
 <p><b>sottolavello H 73</b> <b>1 cestone H 60 con scarico salvaspazio</b> sink base unit H 73 1 deep drawer H 60 with space-saver drain piping</p>	L 60	E5260600	259			
	L 90	E5260900	300			

**LE BASI NON SONO COMPRENSIVE DI TOP**  
THE BASE UNITS DO NOT INCLUDE THE TOPS

		COD.	JEY K24				
 <p><b>base H 36</b> <b>1 ante</b> base unit H 36 1 door</p>	L 45	E4321451/2	136				
	L 60	E4321601/2	147				
 <p><b>base H 48</b> <b>1 ante</b> base unit H 48 1 door</p>	L 45	E4320451/2	156				
	L 60	E4320601/2	167				
 <p><b>base H 60</b> <b>1 ante</b> base unit H 60 1 door</p>	L 45	E4322451/2	169				
	L 60	E4322601/2	182				
 <p><b>base H 36</b> <b>2 ante</b> base unit H 36 2 doors</p>	L 90	E4321900	196				
	L 120	E4322200	215				
 <p><b>base H 48</b> <b>2 ante</b> base unit H 48 2 doors</p>	L 90	E4320900	235				
	L 120	E4321200	276				
 <p><b>base H 60</b> <b>2 ante</b> base unit H 60 2 doors</p>	L 90	E4322900	256				

**LE BASI NON SONO COMPRENSIVE DI TOP**  
THE BASE UNITS DO NOT INCLUDE THE TOPS

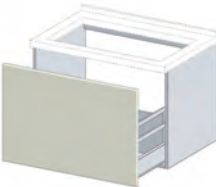
	COD.	JEY K24				
 <p><b>base H 36</b> <b>1 cestone</b> base H 36 1 deep drawer</p>	L 45	E4311450	186			
	L 60	E4311600	201			
	L 90	E4311900	229			
	L 120	E4312200	305			
 <p><b>base H 48</b> <b>1 cestone</b> base unit H 48 1 deep drawer</p>	L 45	E4310450	197			
	L 60	E4310600	210			
	L 90	E4310900	243			
	L 120	E4311200	316			
 <p><b>base H 60</b> <b>1 cestone</b> <b>1 cassetto interno</b> base unit H 60 1 deep drawer 1 internal drawer</p>	L 45	E4312450	315			
	L 60	E4312600	338			
	L 90	E4312900	398			
 <p><b>sottolavello H 48</b> <b>1 cestone sagomato scarico salvaspazio</b> sink base unit H 48 1 contoured deep drawer space-saver drain piping</p>	L 90	E5240900	299			
 <p><b>sottolavello H 60</b> <b>1 cestone scarico salvaspazio</b> sink base unit H 60 1 deep drawer with space-saver drain piping</p>	L 60	E5250600	272			
	L 90	E5250900	309			

# COMPOSIZIONE CON ELEMENTI INCLINATI

## COMPOSITION WITH INCLINED ELEMENTS

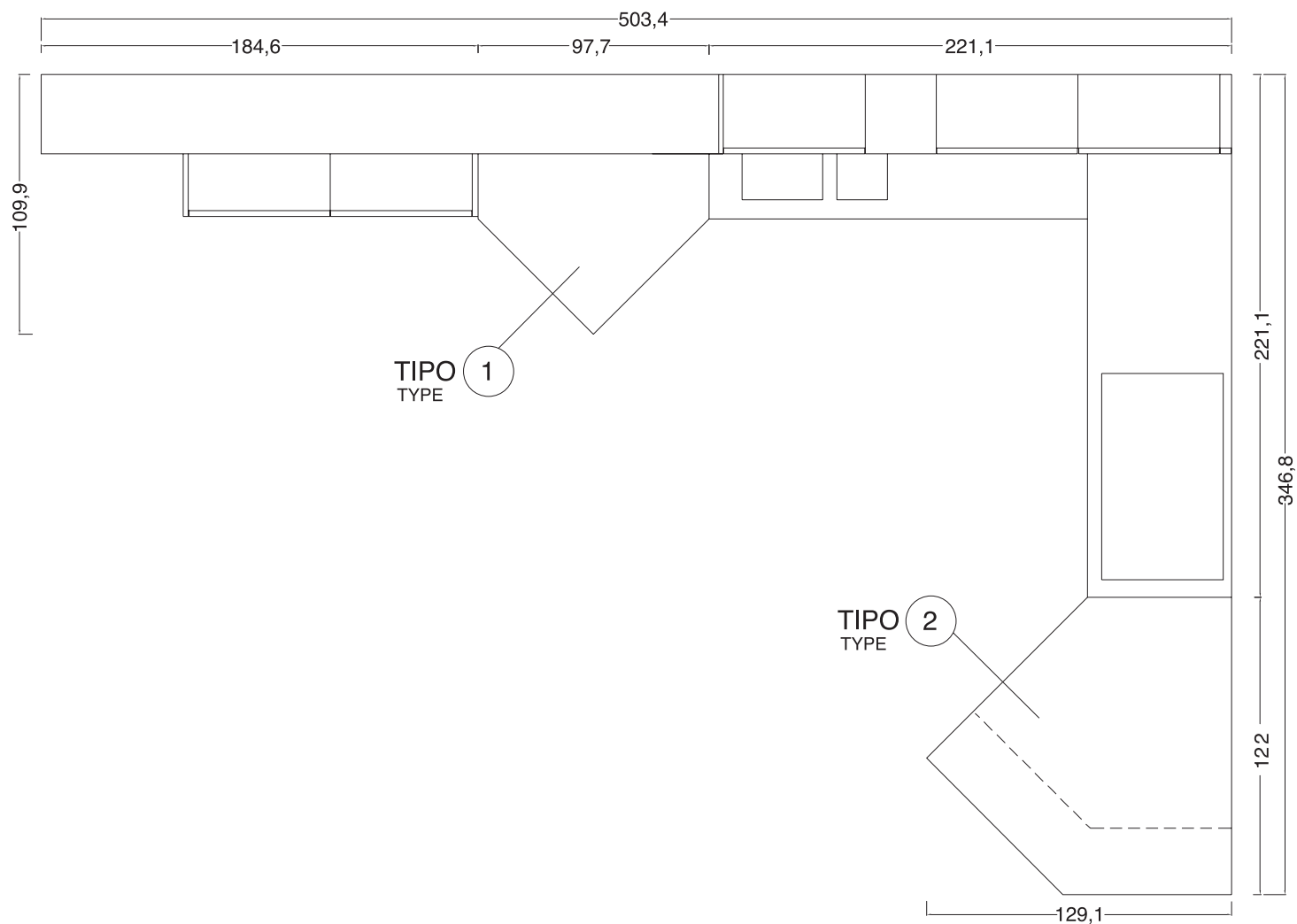
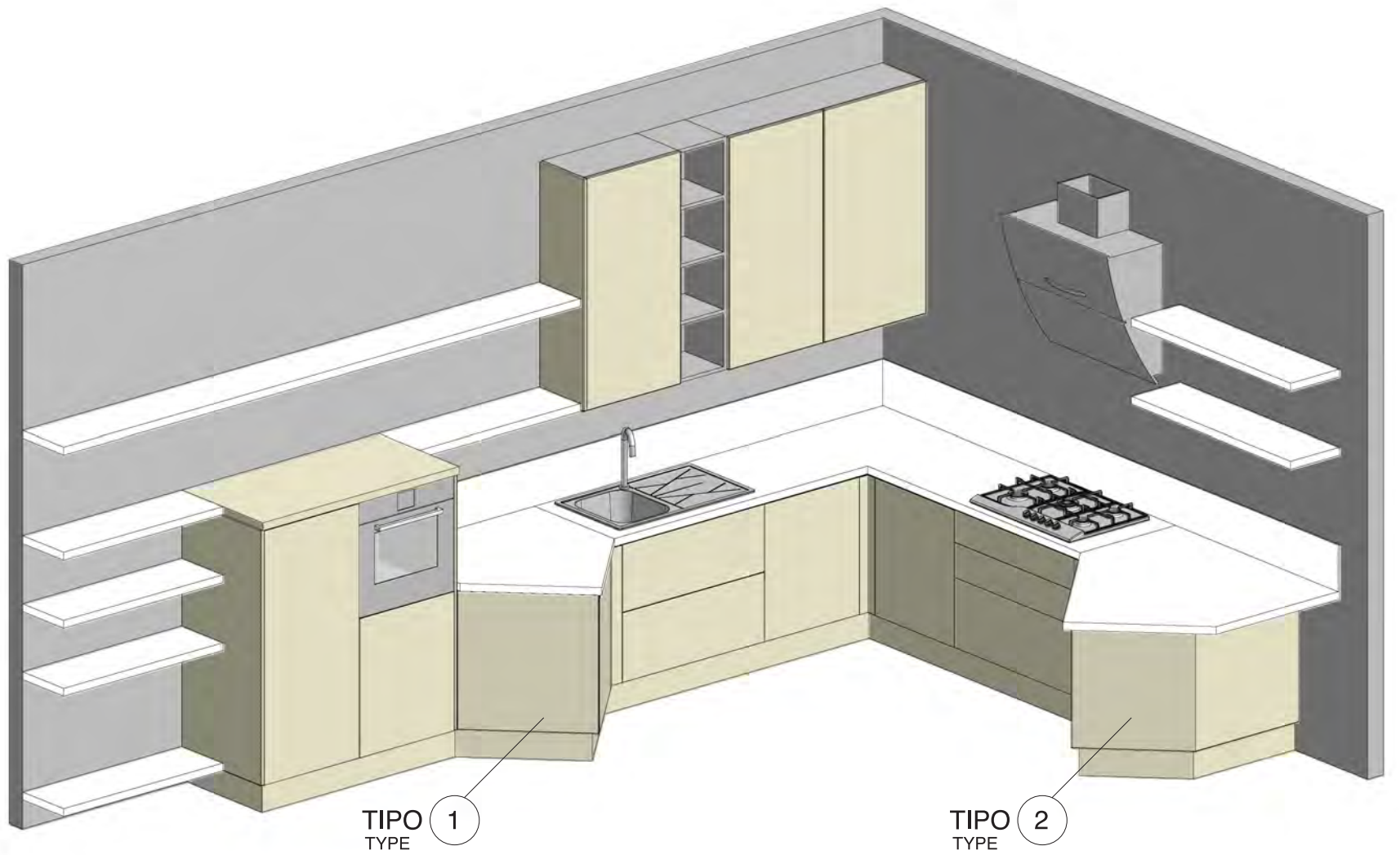

# BASE INCLINATA "TIPO 1"

INCLINED BASE UNIT "TYPE 1"

**LE BASI NON SONO COMPRENSIVE DI TOP**  
THE BASE UNITS DO NOT INCLUDE THE TOPS

**kit base inclinata "tipo 1" per vano L 60**  
inclined base unit "type 1" kit W 60

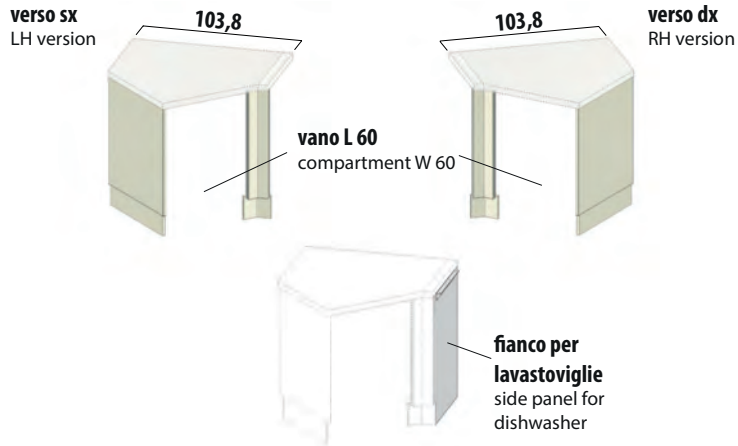

kit "tipo 1"  
"type 1" kit

mag. inserimento fianco per lavastoviglie dx o sx  
surcharge for dishwasher side panel placed on RH or LH side

**top per base inclinata "tipo 1"**  
worktop for inclined base unit "type 1"

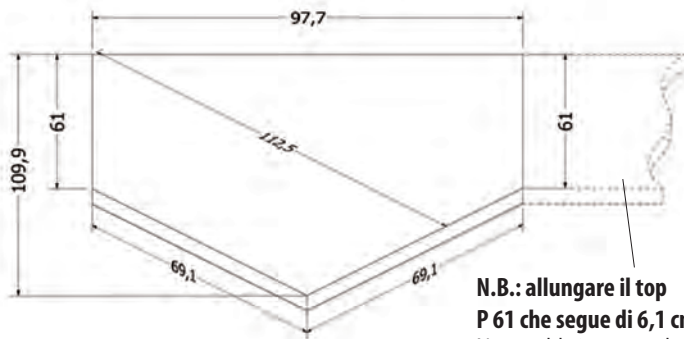

verso sx  
LH version

**N.B.: allungare il top P 61 che segue di 6,1 cm**  
Note: add. 6,1 cm to the worktop next to the inclined base unit

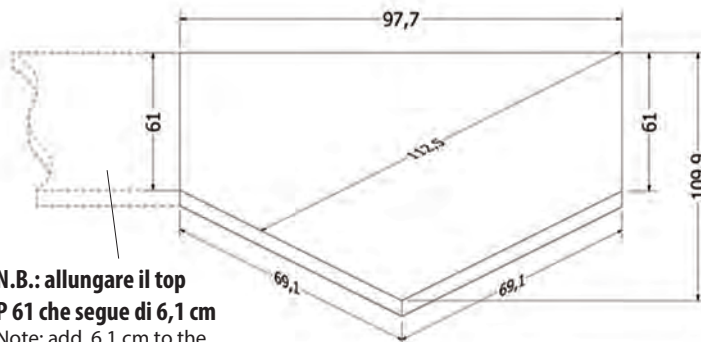

verso dx  
RH version

**N.B.: allungare il top P 61 che segue di 6,1 cm**  
Note: add. 6,1 cm to the worktop next to the inclined base unit

97,7x109,9 lamin.bordo ABS1

H 4

97,7x109,9 laminato Fenix NTM

H 2

H 4

97,7x109,9 quarzo pasta piena profilo P

H 2

fascia "A"

fascia "B"

fascia "C"

H 3

fascia "A"

fascia "B"

fascia "C"

97,7x109,9 quarzo bordo quarzo profilo P

H 4

fascia "A"

fascia "B"

fascia "C"

COD.

JEY  
K24

E4910051/2

164

opz.002

+40

VEDI

LISTINO

PREZZI

VEDI

LISTINO

PREZZI

TQRP2681/2

VEDI

LISTINO

PREZZI

TQRP3681/2

VEDI

LISTINO

PREZZI

TQRP4681/2

VEDI

LISTINO

PREZZI



# BASE INCLINATA SNACK "TIPO 2"

INCLINED SNACK BASE UNIT "TYPE 2"

**LE BASI NON SONO COMPRENSIVE DI TOP**  
THE BASE UNITS DO NOT INCLUDE THE TOPS

COD.

**JEY**  
K24

## kit base snack "tipo 2" per vano L 60

inclined snack base unit "type 2" kit W 60

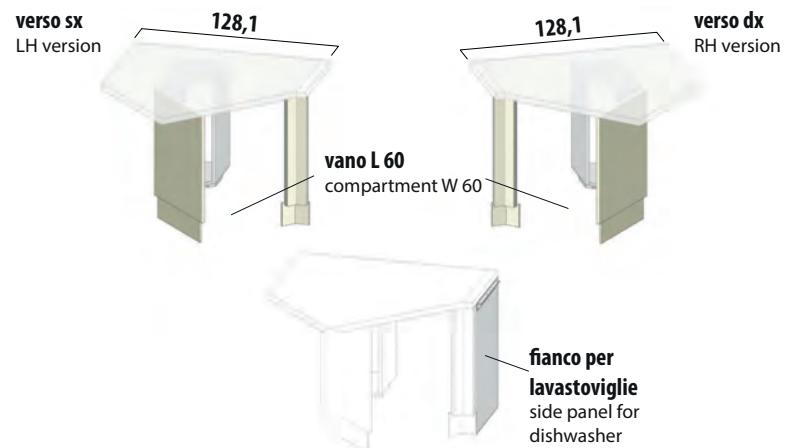

kit "tipo 2"  
"type 2" kit

E4910071/2

330

**mag. inserimento fianco per lavastoviglie dx o sx**  
surcharge for dishwasher side panel placed on RH or LH side

opz.002

+40

## top per base snack "tipo 2"

worktop for inclined snack base unit "type 2"

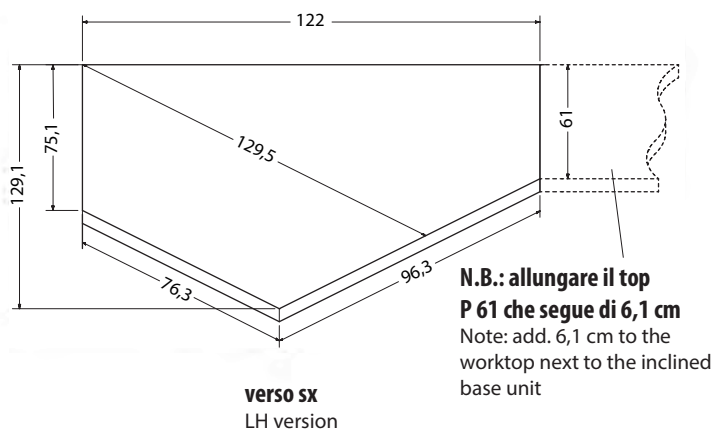

**N.B.: allungare il top P 61 che segue di 6,1 cm**  
Note: add. 6,1 cm to the worktop next to the inclined base unit

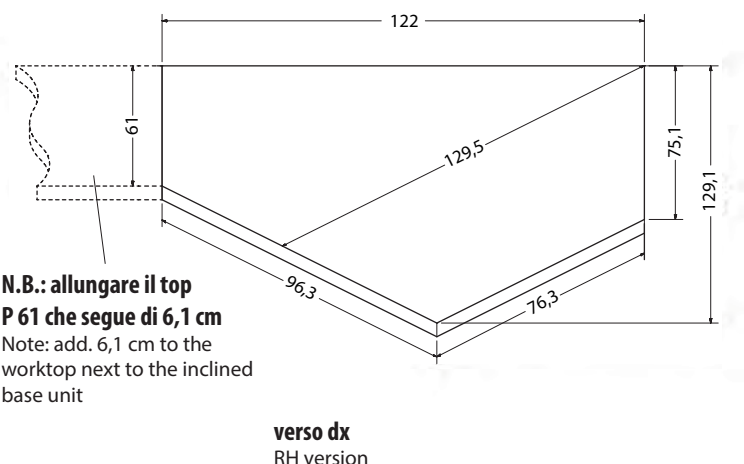

**N.B.: allungare il top P 61 che segue di 6,1 cm**  
Note: add. 6,1 cm to the worktop next to the inclined base unit

122x129,1 lamin.bordo ABS1

VEDI

H 4

T9062631/2

LISTINO

PREZZI

122x129,1 laminato Fenix NTM

VEDI

H 2

TFEN2691/2

LISTINO

PREZZI

122x129,1 quarzo pasta piena profilo P

H 2

TQRP2691/2

fascia "A"

VEDI

fascia "B"

LISTINO

fascia "C"

PREZZI

H 3

TQRP3691/2

fascia "A"

VEDI

fascia "B"

LISTINO

fascia "C"

PREZZI

Foro rettangolare

T9FRE

122x129,1 quarzo bordo quarzo profilo P

H 4

TQRP4691/2

fascia "A"

VEDI

fascia "B"

LISTINO







fascia "C"





PREZZI





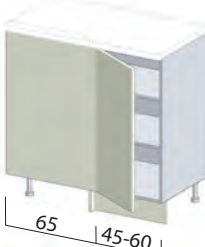
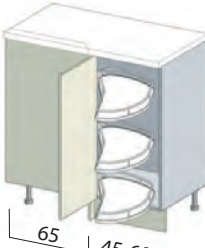

Foro rettangolare







T9FRE

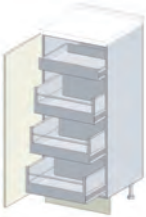

LE COLONNE NON SONO COMPRENSIVE DI TOP THE COLUMNS DO NOT INCLUDE THE TOPS		COD.	JEY K24				
 <p><b>fascia tamponamento da 5 a 15</b> filler panel size from 5 to 15</p> <p>96</p>							
	<p><b>in nobilitato</b> melamine coated</p>	E6000010	36				
	<p><b>come anta con supporto</b> same as door with support</p>	E6000140	85				
 <p><b>1 anta</b> 1 door</p>							
	L 30	E6040301/2	189				
	L 40	E6040401/2	210				
	L 45	E6040451/2	210				
	L 60	E6040601/2	235				
 <p><b>2 ante</b> <b>2 ripiani con tirante centrale</b> 2 doors 2 shelves with central tie beam</p>							
	L 90	E6041900	344				
 <p><b>1 anta vetro</b> 1 glass door</p>							
	L 45	E6047451/2	371				
 <p><b>2 ante vetro</b> 2 glass doors</p>							
	L 90	E6047900	664				
 <p><b>1 cassetto H 24</b> <b>2 cestoni H 36</b> 1 drawer H 24 2 deep drawers H 36</p>							
	L 60	E6031620	418				

LE COLONNE NON SONO COMPRENSIVE DI TOP THE COLUMNS DO NOT INCLUDE THE TOPS		COD.	JEY K24				
 <p><b>1 cassetto H 24</b> <b>1 cestone H 36</b> <b>1 cestone vetro H 36</b> 1 drawer H 24 1 deep drawer H 36 1 glass deep drawer H 36</p>	L 60	E6032610	543				
	<p><b>predisposta per lavastoviglie Electrolux KESC 5300L - AEG FSE63307P</b> configured for Electrolux KESC 5300L - AEG FSE63307P dishwasher</p> 		L 60	E6570600	295		
 <p><b>angolo 2 ripiani con tirante centrale</b> <b>1 anta (cerniere a pilastro)</b> <b>pannello come anta sp. 2,2</b> corner unit 2 shelves with central tie beam 1 door (pillar hinges) panel as door Th. 2,2</p> <p>65   45-60</p>	L 110 P 59,9	E6327111/2	359				
	L 125 P 59,9	E6327261/2	387				
 <p><b>angolo 3 cestelli "TRAYS" ad estrazione totale</b> <b>1 anta</b> <b>pannello come anta sp. 2,2</b> corner unit 3 "TRAYS" pull-out basket units (fully extending) 1 door panel as door Th. 2,2</p> <p>65   45-60</p>	L 110 P 59,9	E6328111/2	1.039				
	L 125 P 59,9	E6328261/2	1.115				
 <p><b>jolly colonna</b> <b>L da 10 a 30</b> jolly column size from 10 to 30</p>							
		<p><b>colore come struttura</b> same colour as carcass</p> <p><b>colore come anta</b> same colour as door</p>	E6000900	190			
		E6000930	250				

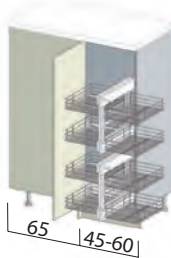





LE COLONNE NON SONO COMPRENSIVE DI TOP THE COLUMNS DO NOT INCLUDE THE TOPS		COD.	JEY K24				
 <p><b>fascia tamponamento da 5 a 15</b> filler panel size from 5 to 15</p> <p>132</p>							
		<b>in nobilitato</b> melamine coated	E6000020	38			
		<b>come anta con supporto</b> same as door with support	E6000150	102			
 <p><b>1 anta</b> 1 door</p>							
	L 30	E6050301/2	229				
	L 45	E6050451/2	255				
	L 60	E6050601/2	280				
 <p><b>2 ante</b> <b>2 ripiani con tirante centrale</b> 2 doors 2 shelves with central tie beam</p>							
	L 90	E6050900	428				
 <p><b>1 anta vetro</b> 1 glass door</p>							
	L 45	E6182451/2	449				
	L 60	E6182601/2	499				
 <p><b>2 ante vetro</b> 2 glass doors</p>							
	L 90	E6182900	810				
 <p><b>1 anta integrata al gruppo cestelli estraibili</b> <b>in filo orion grau</b> <b>chiusura soft</b> 1 door incorporated into the orion grau wire pull-out basket units soft-closing system</p>							
	L 30	E6150300	553				
 <p><b>1 anta (cerniere 180°)</b> <b>1 cassetto interno</b> <b>3 cestoni interni</b> <b>posizionare sempre a 5 cm dalla parete laterale</b> 1 door (180° hinges) 1 internal drawer 3 internal deep drawers <b>should always be placed at 5 cm from the side wall</b></p>							
	L 45	E6158481/2	579				
	L 60	E6158631/2	626				

LE COLONNE NON SONO COMPRENSIVE DI TOP THE COLUMNS DO NOT INCLUDE THE TOPS		COD.	JEY K24				
 <p><b>1 anta</b> <b>gruppo cestelli estraibili in filo orion grau</b> <b>chiusura soft</b> 1 door orion grau wire pull-out basket units soft-closing system</p>	L 45	E6150451/2	582				
	L 60	E6150601/2	612				
 <p><b>1 anta vetro</b> <b>gruppo cestelli estraibili in filo orion grau</b> <b>chiusura soft</b> 1 glass door orion grau wire pull-out basket units soft-closing system</p>	L 45	E6152461/2	774				
	L 60	E6152611/2	830				
 <p><b>angolo 2 ripiani con tirante centrale</b> <b>1 anta (cerniere a pilastro)</b> <b>pannello come anta sp.2,2</b> corner unit 2 shelves with central tie beam 1 door (hinges pillar) panel as door Th. 2,2</p>	L 110 P 59,9	E6336111/2	441				
	L 125 P 59,9	E6336261/2	459				
 <p><b>angolo 4 cestelli "TRAYS" ad estrazione totale</b> <b>1 anta</b> <b>pannello come anta sp.2,2</b> corner unit 4 "TRAYS" pull-out basket units (fully extending) 1 door panel as door Th. 2,2</p>	L 110 P 59,9	E6334111/2	1.331				
	L 125 P 59,9	E6334261/2	1.421				
 <p><b>angolo 8 cestelli estraibili indipendenti all'anta</b> <b>1 anta</b> <b>pannello come anta sp.2,2</b> corner unit 8 pull-out basket units independent from door 1 door panel as door Th. 2,2</p>	L 110 P 59,9	E6335121/2	1.336				
	L 125 P 59,9	E6335271/2	1.490				
 <p><b>jolly colonna</b> <b>L da 10 a 30</b> jolly column size from 10 to 30</p>		E6001000	237				
		E6001030	323				







colore come struttura  
same colour as carcass





colore come anta  
same colour as door





		COD.	JEY				
<p><b>fascia tamponamento da 5 a 15 (senza presa maniglia)</b> filler panel size from 5 to 15 (without handle grip)</p> <p>204</p>			K24				
	<b>in nobilitato melamine coated</b>	E6000050	45				
	<b>come anta con supporto same as door with support</b>	E6000200	120				
<p><b>2 ante anta superiore H 72 anta inferiore H 132</b> 2 doors upper door H 72 lower door H 132</p>							
	<b>L 45 P 33,4</b>	E6013451/2	314				
	<b>L 60 P 33,4</b>	E6013601/2	354				
<p><b>2 ante anta superiore H 72 anta inferiore H 132</b> 2 doors upper door H 72 lower door H 132</p>							
	<b>L 30 P 59,9</b>	E6060301/2	337				
	<b>L 45 P 59,9</b>	E6063451/2	373				
	<b>L 60 P 59,9</b>	E6063601/2	425				
<p><b>2 ante anta superiore H 132 anta inferiore H 72</b> 2 doors upper door H 132 lower door H 72</p>							
	<b>L 45 P 33,4</b>	E6010451/2	314				
	<b>L 60 P 33,4</b>	E6010601/2	354				
<p><b>2 ante anta superiore H 132 anta inferiore H 72</b> 2 doors upper door H 132 lower door H 72</p>							
	<b>L 45 P 59,9</b>	E6060451/2	373				
	<b>L 60 P 59,9</b>	E6060601/2	425				
<p><b>L 75 P 59,9</b></p>	E606075A1/2	511					
	<p><b>4 ante 2 ante superiori H 132 2 ante inferiori H 72 4 ripiani con tirante centrale</b> 4 doors 2 upper doors H 132 2 lower doors H 72 4 shelves with central tie beam</p>						
		<b>L 90 P 59,9</b>	E6060900	638			
<p><b>1 anta H 204 (presa maniglia verticale)</b> 1 door H 204 (vertical handle grip)</p>							
	<b>L 45 P 59,9</b>	E6061451/2	359				
	<b>L 60 P 59,9</b>	E6061601/2	435				



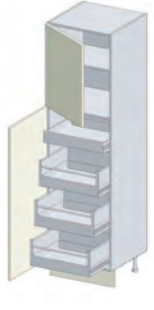



	COD.	JEY K24				
 <p><b>2 ante H 204</b> <b>(presa maniglia verticale)</b> <b>4 ripiani con tirante centrale</b> 2 doors H 204 (vertical handle grip) 4 shelves with central tie beam</p>	L 90	E6061900	603			
 <p><b>portascope</b> <b>2 ante</b> <b>anta superiore H 72</b> <b>anta inferiore H 132</b> broom cabinet 2 doors upper door H 72 lower door H 132</p>	L 30	E6100301/2	340			
	L 45	E6100451/2	368			
 <p><b>portascope con ripiani</b> <b>2 ante</b> <b>anta superiore H 72</b> <b>anta inferiore H 132</b> broom cabinet with shelves 2 doors upper door H 72 lower door H 132</p>	L 60	E6100601/2	453			
 <p><b>1 anta H 132</b> <b>4 cassetti H 18</b> 1 door H 132 4 drawers H 18</p>	L 45	E6065451/2	579			
	L 60	E6065601/2	625			
 <p><b>1 anta H 132</b> <b>2 cassetti H 18</b> <b>1 cestone H 36</b> 1 door H 132 2 drawers H 18 1 deep drawer H 36</p>	L 45	E6065461/2	525			
	L 60	E6065611/2	568			
 <p><b>1 anta H 132</b> <b>2 cestoni H 36</b> 1 door H 132 2 deep drawers H 36</p>	L 45	E6066451/2	471			
	L 60	E6066601/2	512			















		COD.	JEY K24				
 <p><b>2 ante vetro</b> <b>anta superiore H 132</b> <b>anta inferiore H 72</b> 2 glass doors upper door H 132 lower door H 72</p>	L 45 P 33,4	E6203461/2	684				
	L 60 P 33,4	E6203611/2	757				
 <p><b>2 ante vetro</b> <b>anta superiore H 132</b> <b>anta inferiore H 72</b> 2 glass doors upper door H 132 lower door H 72</p>	L 45 P 59,9	E6203451/2	703				
	L 60 P 59,9	E6203601/2	782				
 <p><b>2 ante</b> <b>anta vetro H 132</b> <b>anta chiusa H 72</b> 2 doors glass door H 132 full door H 72</p>	L 45 P 33,4	E6205451/2	538				
	L 60 P 33,4	E6205601/2	596				
 <p><b>2 ante</b> <b>anta vetro H 132</b> <b>anta chiusa H 72</b> 2 doors glass door H 132 full door H 72</p>	L 45 P 59,9	E6204451/2	557				
	L 60 P 59,9	E6204601/2	621				
 <p><b>4 ante</b> <b>2 ante vetro H 132</b> <b>2 ante chiuse H 72</b> 4 doors 2 glass doors H 132 2 full doors H 72</p>	L 90 P 59,9	E6204900	1.013				
 <p><b>1 anta vetro H 132</b> <b>4 cassetti H 18</b> 1 glass door H 132 4 drawers H 18</p>	L 45 P 59,9	E6287451/2	769				
	L 60 P 59,9	E6287601/2	843				





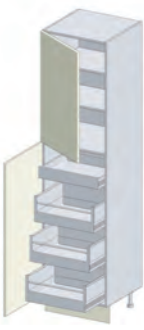

	COD.	JEY K24				
 <p><b>1 anta vetro H 132</b>  <b>2 cassetti H 18</b>  <b>1 cestone H 36</b>                      1 glass door H 132                      2 drawers H 18                      1 deep drawer H 36</p>	L 45	E6287461/2	723			
	L 60	E6287611/2	792			
 <p><b>1 anta vetro H 132</b>  <b>2 cestoni H 36</b>                      1 glass door H 132                      2 deep drawers H 36</p>	L 45	E6288451/2	678			
	L 60	E6288601/2	746			
 <p><b>anta H 204 integrata al gruppo cestelli estraibili</b>  <b>(presa maniglia verticale)</b>  <b>in filo orion grau</b>  <b>chiusura soft</b>                      door H 204 incorporated into the orion grau wire                      (vertical handle grip)                      pull-out basket unit                      soft-closing system</p>	L 30	E6163301/2	736			
	L 45	E6163451/2	795			
 <p><b>1 anta superiore H 72</b>  <b>1 anta H 132 integrata al gruppo cestelli estraibili in filo orion grau</b>  <b>chiusura soft</b>                      1 upper door H 72                      1 door H 132 incorporated into the orion grau wire                      pull-out basket units                      soft-closing system</p>	L 30	E6160301/2	657			
 <p><b>1 anta superiore H 72</b>  <b>1 anta inferiore H 132</b>  <b>gruppo cestelli estraibili in filo orion grau</b>  <b>chiusura soft</b>                      1 upper door H 72                      1 lower door H 132                      orion grau wire pull-out basket units                      soft-closing system</p>	L 45	E6160451/2	700			
	L 60	E6160601/2	745			
 <p><b>1 anta superiore H 72 (cerniere 100°)</b>  <b>1 anta inferiore H 132 (cerniere 180°)</b>  <b>1 cassetto interno</b>  <b>3 cestoni interni</b>  <b>posizionare sempre a 5 cm dalla parete laterale</b>                      1 upper door H 72 (100° hinges)                      1 lower door H 132 (180° hinges)                      1 internal drawer                      3 internal deep drawers                      should always be placed at 5 cm from the side wall</p>	L 45	E6086481/2	636			
	L 60	E6086631/2	696			

	COD.	JEY				
 <p><b>angolo 4 ripiani con tirante centrale</b>  <b>1 anta superiore H 72</b>  <b>1 anta inferiore H 132</b>  <b>(cerniere a pilastro)</b>  <b>pannello come anta sp.2,2</b>                      corner unit 4 shelves with central tie beam                      1 upper door H 72                      1 lower door H 132                      (pillar hinges)                      panel as door Th. 2,2</p>	L 110 P 59,9	E6306111/2	629			
	L 125 P 59,9	E6306261/2	647			
 <p><b>angolo 4 cestelli "TRAYS" ad estrazione totale</b>  <b>1 anta superiore H 72</b>  <b>1 anta inferiore H 132</b>  <b>pannello come anta sp.2,2</b>                      corner unit 4 "TRAYS" pull-out basket units (fully extending)                      1 upper door H 72                      1 lower door H 132                      panel as door Th. 2,2</p>	L 110 P 59,9	E6309111/2	1.467			
	L 125 P 59,9	E6309261/2	1.564			
 <p><b>angolo 8 cestelli estraibili indipendenti all'anta</b>  <b>1 anta superiore H 72</b>  <b>1 anta inferiore H 132</b>  <b>pannello come anta sp.2,2</b>                      corner unit 8 pull-out basket units                      1 upper door H 72                      1 lower door H 132                      panel as door Th. 2,2</p>	L 110 P 59,9	E6305121/2	1.472			
	L 125 P 59,9	E6305271/2	1.637			
 <p><b>angolo 1 anta H 204 cerniere 135°</b>  <b>(presa maniglia verticale)</b>  <b>2 fianchi sp. 3,8 come struttura</b>  <b>N.B.: fornita smontata</b>                      corner 1 door H 204 135° hinges                      (vertical handle grip)                      2 side panels Th.3,8 same as carcass  <b>Note: supplied unassembled</b></p>	105,5x105,5	E6341051/2	965			
 <p><b>jolly colonna</b>  <b>L da 15 a 30</b>                      jolly column                      size from 15 to 30</p>						
	colore come struttura same colour as carcass	E6002000	323			
colore come anta same colour as door	E6002030	448				

		COD.	JEY K24				
 <p><b>fascia tamponamento da 5 a 15 (senza presa maniglia)</b> filler panel size from 5 to 15 (without handle grip)</p> <p>228</p>							
	<p><b>in nobilitato melamine coated</b></p>	E6000100	47				
	<p><b>come anta con supporto same as door with support</b></p>	E6000250	126				
 <p><b>2 ante anta superiore H 96 anta inferiore H 132</b> 2 doors upper door H 96 lower door H 132</p>							
	<p><b>L 45 P 33,4</b></p>	E6023451/2	379				
	<p><b>L 60 P 33,4</b></p>	E6023601/2	427				
 <p><b>2 ante anta superiore H 96 anta inferiore H 132</b> 2 doors upper door H 96 lower door H 132</p>							
	<p><b>L 30 P 59,9</b></p>	E6070301/2	371				
	<p><b>L 45 P 59,9</b></p>	E6073451/2	412				
 <p><b>2 ante anta superiore H 156 anta inferiore H 72</b> 2 doors upper door H 156 lower door H 72</p>							
	<p><b>L 45 P 33,4</b></p>	E6020451/2	385				
	<p><b>L 60 P 33,4</b></p>	E6020601/2	433				
 <p><b>2 ante anta superiore H 156 anta inferiore H 72</b> 2 doors upper door H 156 lower door H 72</p>							
	<p><b>L 45 P 59,9</b></p>	E6070451/2	417				
	<p><b>L 60 P 59,9</b></p>	E6070601/2	478				
 <p><b>4 ante 2 ante superiori H 156 2 ante inferiori H 72 4 ripiani con tirante centrale</b> 4 doors 2 upper doors H 156 2 lower doors H 72 4 shelves with central tie beam</p>							
	<p><b>L 90 P 59,9</b></p>	E6070900	714				
 <p><b>portascope 1 anta superiore H 96 1 anta inferiore H 132</b> broom cabinet 1 upper door H 96 1 lower door H 132</p>							
	<p><b>L 30 P 59,9</b></p>	E6110301/2	374				
	<p><b>L 45 P 59,9</b></p>	E6110451/2	407				

		COD.	JEY K24				
 <p><b>portascope con ripiani</b>  <b>1 anta superiore H 96</b>  <b>1 anta inferiore H 132</b>                      broom cabinet with shelves                      1 upper door H 96                      1 lower door H 132</p>	L 60 P 59,9	E6110601/2	499				
 <p><b>1 anta H 156</b>  <b>4 cassetti H 18</b>                      1 door H 156                      4 drawers H 18</p>	L 45 P 59,9	E6075451/2	621				
	L 60 P 59,9	E6075601/2	673				
 <p><b>1 anta H 156</b>  <b>2 cassetti H 18</b>  <b>1 cestone H 36</b>                      1 door H 156                      2 drawers H 18                      1 deep drawer H 36</p>	L 45 P 59,9	E6075461/2	567				
	L 60 P 59,9	E6075611/2	617				
 <p><b>1 anta H 156</b>  <b>2 cestoni H 36</b>                      1 door H 156                      2 deep drawers H 36</p>	L 45 P 59,9	E6076451/2	513				
	L 60 P 59,9	E6076601/2	561				
 <p><b>2 ante vetro</b>  <b>anta superiore H 156</b>  <b>anta inferiore H 72</b>                      2 glass doors                      upper door H 156                      lower door H 72</p>	L 45 P 33,4	E6213461/2	772				
 <p><b>2 ante vetro</b>  <b>anta superiore H 156</b>  <b>anta inferiore H 72</b>                      2 glass doors                      upper door H 156                      lower door H 72</p>	L 45 P 59,9	E6213451/2	791				
 <p><b>2 ante</b>  <b>anta vetro H 156</b>  <b>anta chiusa H 72</b>                      2 doors                      glass door H 156                      full door H 72</p>	L 45 P 33,4	E6215451/2	624				

	COD.	JEY K24				
 <p><b>2 ante</b> <b>anta vetro H 156</b> <b>anta chiusa H 72</b> 2 doors glass door H 156 full door H 72</p>	L 45	E6214451/2	645			
 <p><b>4 ante</b> <b>2 ante vetro H 156</b> <b>2 ante chiuse H 72</b> 4 doors 2 glass doors H 156 2 full doors H 72</p>	L 90	E6214900	1.174			
 <p><b>1 anta vetro H 156</b> <b>4 cassetti H 18</b> 1 glass door H 156 4 drawers H 18</p>	L 45	E6297451/2	855			
 <p><b>1 anta vetro H 156</b> <b>2 cassetti H 18</b> <b>1 cestone H 36</b> 1 glass door H 156 2 drawers H 18 1 deep drawer H 36</p>	L 45	E6297461/2	810			
 <p><b>1 anta vetro H 156</b> <b>2 cestoni H 36</b> 1 glass door H 156 2 deep drawers H 36</p>	L 45	E6298451/2	765			
 <p><b>1 anta superiore H 96 (cerniere 100°)</b> <b>1 anta inferiore H 132 (cerniere 180°)</b> <b>1 cassetto interno</b> <b>3 cestoni interni</b> <b>posizionare sempre a 5 cm dalla parete laterale</b> 1 upper door H 96 (100° hinges) 1 lower door H 132 (180° hinges) 1 internal drawer 3 internal deep drawers <b>should always be placed at 5 cm from the side wall</b></p>	L 45	E6088481/2	673			
	L 60	E6088631/2	739			







	COD.	JEY K24				
 <p><b>1 anta superiore H 96</b>  <b>1 anta H 132 integrata al gruppo cestelli estraibili</b>  <b>in filo orion grau</b>  <b>chiusura soft</b>                      1 upper door H 96                      1 door H 132 incorporated into the orion grau wire                      pull-out basket units                      soft-closing system</p>	L 30	E6170301/2	690			
 <p><b>1 anta superiore H 96</b>  <b>1 anta inferiore H 132 gruppo cestelli estraibili</b>  <b>in filo orion grau</b>  <b>chiusura soft</b>                      1 upper door H 96                      1 lower door H 132 orion grau wire                      pull-out basket units                      soft-closing system</p>	L 45 L 60	E6170451/2 E6170601/2	737 789			
 <p><b>angolo 5 ripiani</b>  <b>1 anta superiore H 96</b>  <b>1 anta inferiore H 132</b>  <b>(cerniere a pilastro)</b>  <b>pannello come anta sp. 2,2</b>                      corner unit 5 shelves                      1 upper door H 96                      1 lower door H 132                      (pillar hinges)                      panel as door Th. 2,2</p>	L 110 P 59,9 L 125 P 59,9	E6316111/2 E6316261/2	676 719			
 <p><b>angolo 4 cestelli "TRAYS" ad estrazione totale</b>  <b>1 anta superiore H 96</b>  <b>1 anta inferiore H 132</b>  <b>pannello come anta sp. 2,2</b>                      corner unit 4 "TRAYS" pull-out basket units (fully extending)                      1 upper door H 96                      1 lower door H 132                      panel as door Th. 2,2</p>	L 110 P 59,9 L 125 P 59,9	E6314111/2 E6314261/2	1.768 1.879			
 <p><b>angolo 8 cestelli estraibili indipendenti all'anta</b>  <b>1 anta superiore H 96</b>  <b>1 anta inferiore H 132</b>  <b>pannello come anta sp. 2,2</b>                      corner unit 8 pull-out basket units independent from door                      1 upper door H 96                      1 lower door H 132                      panel as door Th. 2,2</p>	L 110 P 59,9 L 125 P 59,9	E6315121/2 E6315271/2	1.773 1.952			
 <p><b>jolly colonna</b>  <b>L da 15 a 30</b>                      jolly column                      size from 15 to 30</p>						
		colore come struttura same colour as carcass	E6003000	341		
		colore come anta same colour as door	E6003030	492		

# COLONNE PER FORNO H 109





P 59,9





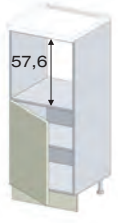

OVEN COLUMNS H 109

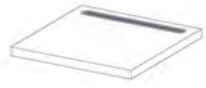
**LE COLONNE NON SONO COMPRENSIVE DI TOP**  
THE COLUMNS DO NOT INCLUDE THE TOPS

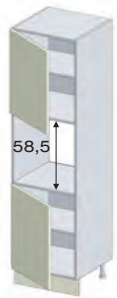



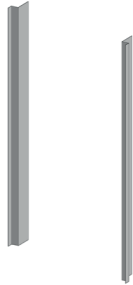

	COD.	JEY K24				
 <p><b>colonna H 109 per forno</b> <b>2 cassetti H 18</b> oven column H 109 2 drawers H 18</p>						
L 60	E6501660	300				
 <p><b>colonna H 109 per forno</b> <b>1 cestone chiuso H 36</b> oven column H 109 1 full deep drawer H 36</p>						
L 60	E6501600	249				
 <p><b>colonna H 109 per forno</b> <b>1 cestone vetro H 36</b> oven column H 109 1 glass deep drawer H 36</p>						
L 60	E6502610	379				
 <p><b>top in laminato H 4</b> <b>P 61 per colonne</b> laminated top H 4 D 61 for columns</p>						
		VEDI				
	al ml per lm	T90035	LISTINO			
	<b>mag.griglia di areazione cad.</b> surcharge for ventilation grille each		TOP			
 <p><b>profilo in acciaio a "L" per rifinire il ripiano del forno e del microonde</b> L-shaped steel finishing profile for shelf of oven and microwave</p>						
	L 60					
	inox stainless steel	08660100	9			
	nero black	08660101	9			
	bianco white	08660102	9			
	L 90					
	inox stainless steel	08660105	12			
 <p><b>kit protezione fianchi per forno</b> protection kit sides for oven</p>						
	coppia couple	08630095	16			







LE COLONNE NON SONO COMPRENSIVE DI TOP THE COLUMNS DO NOT INCLUDE THE TOPS		COD.	JEY K24				
 <p><b>colonna H 145 per forno 1 anta H 72</b> oven column H 145 1 door H 72</p>	L 60	E6520601/2	254				
	L 75	E6520751/2	289				
 <p><b>colonna H 145 per forno 4 cassetti H 18</b> oven column H 145 4 drawers H 18</p>	L 60	E6521610	474				
	L 60	E6521620	418				
 <p><b>colonna H 145 per forno 2 cassetti H 18 1 cestone H 36</b> oven column H 145 2 drawers H 18 1 deep drawer H 36</p>	L 60	E6521630	363				
	L 60	E6521620	418				
 <p><b>colonna H 145 per forno 2 cestoni H 36</b> oven column H 145 2 deep drawers H 36</p>	L 60	E6521630	363				
	L 90	E6521910	439				
 <p><b>top in laminato H 4 P 61 per colonne</b> laminated top H 4 D 61 for columns</p>							
			VEDI				
	al ml per lm	T90035	LISTINO				
	mag.griglia di areazione cad. surcharge for ventilation grille each		TOP				

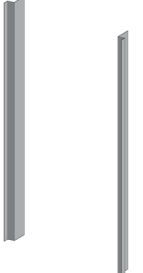

	COD.	JEY K24				
 <p><b>colonna per forno</b>  <b>1 anta superiore H 72</b>  <b>1 anta inferiore H 72</b>                      oven column                      1 upper door H 72                      1 lower door H 72</p>	L 60	E6530601/2	383			
	L 75	E653075A1/2	452			
 <p><b>colonna per forno</b>  <b>1 anta H 72</b>  <b>4 cassetti H 18</b>                      oven column                      1 door H 72                      4 drawers H 18</p>	L 60	E6531611/2	624			
 <p><b>colonna per forno</b>  <b>1 anta H 72</b>  <b>2 cassetti H 18</b>  <b>1 cestone H 36</b>                      oven column                      1 door H 72                      2 drawers H 18                      1 deep drawer H 36</p>	L 60	E6531621/2	567			
 <p><b>colonna per forno</b>  <b>1 anta H 72</b>  <b>2 cestoni H 36</b>                      oven column                      1 door H 72                      2 deep drawers H 36</p>	L 60	E6531631/2	510			
 <p><b>profilo in acciaio a "L" per rifinire il ripiano del forno e del microonde</b>                      L-shaped steel finishing profile for shelf of oven and microwave</p> 	L 60					
	inox stainless steel	08660100	9			
	nero black	08660101	9			
	bianco white	08660102	9			
 <p><b>kit protezione fianchi per forno</b>                      protection kit sides for oven</p> 	coppia couple	08630095	16			

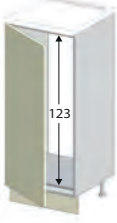

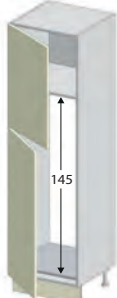
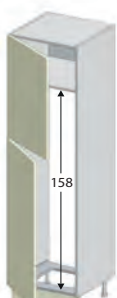



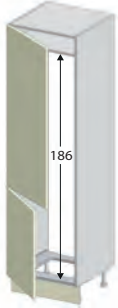
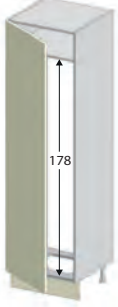
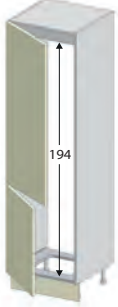

	COD.	JEY K24				
 <p><b>colonna per forno</b>  <b>1 anta superiore H 96</b>  <b>1 anta inferiore H 72</b>                      oven column                      1 upper door H 96                      1 lower door H 72</p> <p>58,5</p>	L 60	E6540601/2	428			
 <p><b>colonna per forno</b>  <b>1 anta H 96</b>  <b>4 cassetti H 18</b>                      oven column                      1 door H 96                      4 drawers H 18</p> <p>58,5</p>	L 60	E6541611/2	656			
 <p><b>colonna per forno</b>  <b>1 anta superiore H 96</b>  <b>2 cassetti H 18</b>  <b>1 cestone H 36</b>                      oven column                      1 upper door H 96                      2 drawers H 18                      1 deep drawer H 36</p> <p>58,5</p>	L 60	E6541621/2	599			
 <p><b>colonna per forno</b>  <b>1 anta superiore H 96</b>  <b>2 cestoni H 36</b>                      oven column                      1 upper door H 96                      2 deep drawers H 36</p> <p>58,5</p>	L 60	E6541631/2	542			
 <p><b>profilo in acciaio a "L" per rifinire il ripiano del forno e del microonde</b>                      L-shaped steel finishing profile for shelf of oven and microwave</p> 	L 60					
	inox stainless steel	08660100	9			
	nero black	08660101	9			
	bianco white	08660102	9			
 <p><b>kit protezione fianchi per forno</b>                      protection kit sides for oven</p> 	coppia couple	08630095	16			







LE COLONNE NON SONO COMPRENSIVE DI TOP THE COLUMNS DO NOT INCLUDE THE TOPS		COD.	JEY K24				
 <p><b>colonna H 145 per frigo 215 monoporta</b> column H 145 for single-door fridge 215</p>							
	L 60	E6452151/2	300				
 <p><b>colonna H 217 per frigo 215 monoporta</b> <b>1 anta superiore H 72</b> <b>1 anta inferiore H 132</b> column H 217 for 215 single-door fridge 1 upper door H 72 1 lower door H 132</p>							
	L 60	E6462151/2	413				
 <p><b>colonna H 217 per frigo-freezer 230</b> <b>1 anta superiore H 84</b> <b>1 anta inferiore H 120</b> column H 217 for 230 fridge-freezer 1 upper door H 84 1 lower door H 120</p>							
	L 60	E6462311/2	413				
 <p><b>colonna H 217 per frigo-freezer 280</b> <b>1 anta superiore H 84</b> <b>1 anta inferiore H 120</b> column H 217 for 280 fridge-freezer 1 upper door H 84 1 lower door H 120</p>							
	L 60	E6462861/2	413				
 <p><b>colonna H 217 per frigo-congelatore 315</b> <b>1 anta superiore H 132</b> <b>1 anta inferiore H 72</b> column H 217 for 315 fridge-freezer 1 upper door H 132 1 lower door H 72</p>							
	L 60	E6463151/2	413				
 <p><b>colonna H 217 per frigo-congelatore 315</b> <b>1 anta superiore H 24</b> <b>1 anta centrale H 108</b> <b>1 anta inferiore H 72</b> column H 217 for 315 fridge-freezer 1 upper door H 24 1 central door H 108 1 lower door H 72</p>							
	L 60	E6463161/2	415				

	COD.	JEY K24				
 <p><b>colonna H 217 per frigo-congelatore 330</b>  <b>1 anta superiore H 132</b>  <b>1 anta inferiore H 72</b>                      column H 217 for 330 fridge-freezer                      1 upper door H 132                      1 lower door H 72</p>	L 60	E6463301/2	413			
 <p><b>colonna H 217 per frigo-freezer 300 monoporta</b>  <b>1 anta H 204 (presa maniglia verticale)</b>                      column H 217 for 300 single-door fridge-freezer                      1 door H 204 (vertical handle grip)</p>	L 60	E6463001/2	413			
 <p><b>colonna H 217 per frigo-congelatore 350</b>  <b>1 anta superiore H 132</b>  <b>1 anta inferiore H 72</b>                      column H 217 for 350 fridge-freezer                      1 upper door H 132                      1 lower door H 72</p>	L 60	E6463511/2	413			
 <p><b>colonna H 217 per frigo-congelatore 400</b>  <b>1 anta superiore H 132</b>  <b>1 anta inferiore H 72</b>                      column H 217 for 400 fridge-freezer                      1 upper door H 132                      1 lower door H 72</p>	L 75	E6464001/2	475			

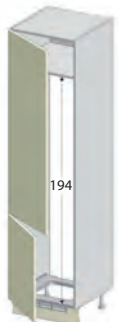
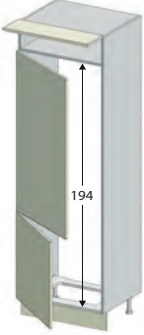
	COD.	JEY K24				
 <p><b>colonna H 241 per frigo 215 monoporta</b>  <b>1 anta superiore H 96</b>  <b>1 anta inferiore H 132</b>                      column H 241 for 215 single-door fridge                      1 upper door H 96                      1 lower door H 132</p>	L 60	E6472151/2	470			
 <p><b>colonna H 241 per frigo-freezer 230</b>  <b>1 anta superiore H 108</b>  <b>1 anta inferiore H 120</b>                      column H 241 for 230 fridge-freezer                      1 upper door H 108                      1 lower door H 120</p>	L 60	E6472311/2	455			
 <p><b>colonna H 241 per frigo-freezer 280</b>  <b>1 anta superiore H 108</b>  <b>1 anta inferiore H 120</b>                      column H 241 for 280 fridge-freezer                      1 upper door H 108                      1 lower door H 120</p>	L 60	E6472861/2	455			
 <p><b>colonna H 241 per frigo-congelatore 315</b>  <b>1 anta superiore H 156</b>  <b>1 anta inferiore H 72</b>                      column H 241 for 315 fridge-freezer                      1 upper door H 156                      1 lower door H 72</p>	L 60	E6473151/2	455			
 <p><b>colonna H 241 per frigo-congelatore 315</b>  <b>1 anta superiore H 48</b>  <b>1 anta centrale H 108</b>  <b>1 anta inferiore H 72</b>                      column H 241 for 315 fridge-freezer                      1 upper door H 48                      1 central door H 108                      1 lower door H 72</p>	L 60	E6473161/2	455			
 <p><b>colonna H 241 per frigo-congelatore 330</b>  <b>1 anta superiore H 156</b>  <b>1 anta inferiore H 72</b>                      column H 241 for 330 fridge-freezer                      1 upper door H 156                      1 lower door H 72</p>	L 60	E6473301/2	455			



	COD.	JEY K24				
 <p><b>colonna H 241 per frigo-congelatore 300 monoporta</b>  <b>1 anta superiore H 48</b>  <b>1 anta inferiore H 180 (presa maniglia verticale)</b>                      column H 241 for 300 single-door fridge-freezer                      1 upper door H 48                      1 lower door H 180 (vertical handle grip)</p>						
L 60	E6473001/2	455				
 <p><b>colonna H 241 per frigo-congelatore 350</b>  <b>1 anta superiore H 156</b>  <b>1 anta inferiore H 72</b>                      column H 241 for 350 fridge-freezer                      1 upper door H 156                      1 lower door H 72</p>						
L 60	E6473511/2	455				
 <p><b>colonna H 241 per frigo-congelatore 400</b>  <b>1 anta superiore a ribalta H 24 TIP-ON</b>  <b>1 anta centrale H 132</b>  <b>1 anta inferiore H 72</b>                      column H 241 for 400 fridge-freezer                      1 upper flap door H 24 TIP-ON                      1 central door H 132                      1 lower door H 72</p>						
L 75	E6474101/2	597				

		COD.	JEY K24				
 <p><b>sopracolonna 1 anta</b> top column 1 door</p>	H 36 L 45	EC601451/2	147				
	L 60	EC601601/2	161				
	ribalta TIP-ON L 75	EC61076T	220				
	H 48 L 45	EC602451/2	175				
	L 60	EC602601/2	191				
	ribalta TIP-ON L 75	EC61276T	275				
 <p><b>sopracolonna 1 anta vetro</b> top column 1 glass door</p>	telaio alluminio H 48 L 45	EC606461/2	316				
	L 60	EC606611/2	342				
 <p><b>fianco per colonna</b> side panel for column</p>	fianco side panel						
	H 239,7x59,9x2,2	T94575	165				
	H 251,7x59,9x2,2	T94580	172				

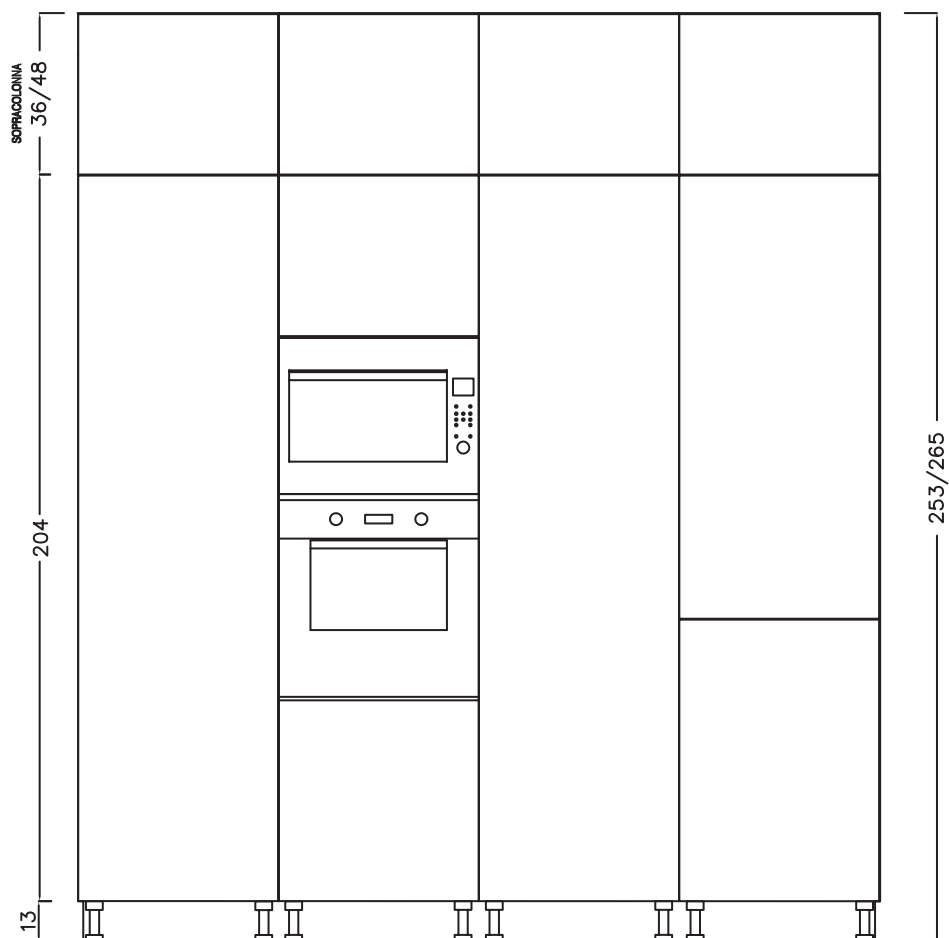

**N.B.: il sistema a ponte può essere realizzato solo tra due colonne**

Note: the bridge system realized only between 2 columns

COD.

**JEY**

K24

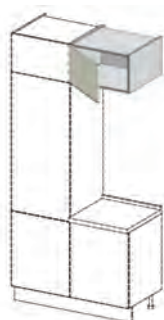

**sopracolonna per sistema ponte  
1 anta**

top column for bridge system  
1 door

H 36 L 45	EC601461/2	147
L 60	EC601611/2	161
2 ante L 90	EC601910	219
H 48 L 45	EC602461/2	175
L 60	EC602611/2	191
2 ante L 90	EC602910	262

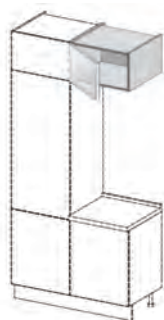

**sopracolonna per sistema ponte  
1 anta vetro**

top column for bridge system  
1 door

telaio alluminio H 48 L 45	EC606471/2	316
L 60	EC606621/2	342
2 ante L 90	EC606920	563

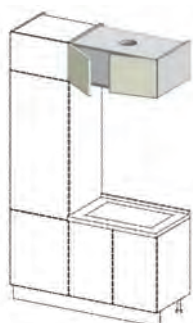

**cappa aspirante integrata totale con luce led e comando remoto, 2 ante**

- L 90 portata 696 m<sup>3</sup>/h classe energetica A  
- L 120 portata 730 m<sup>3</sup>/h classe energetica B

(depuratore fornito smontato)

fully integrated extractor hood with bar led and remote control, 2 doors

- W 90 air flow rate 696 m<sup>3</sup>/h energetic class A

- W 120 air flow rate 730 m<sup>3</sup>/h energetic class B

(purifier supplied unassembled)

H 36 L 90	EPC00900	1.342
L 120	EPC01200	1.711
H 48 L 90	EPC01900	1.379
L 120	EPC02200	1.751

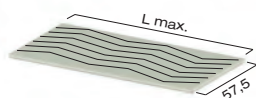

**pannello di finitura  
come anta sp.1,8  
venature orizzontali**

finishing panel same as door th.1,8  
horizontal grains

L.max 275 melaminico  
max.lenght 275 melamine

**CAPPA PER SOPRACOLONNA**

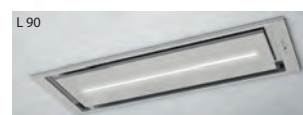

**DETTAGLIO PANNELLO**

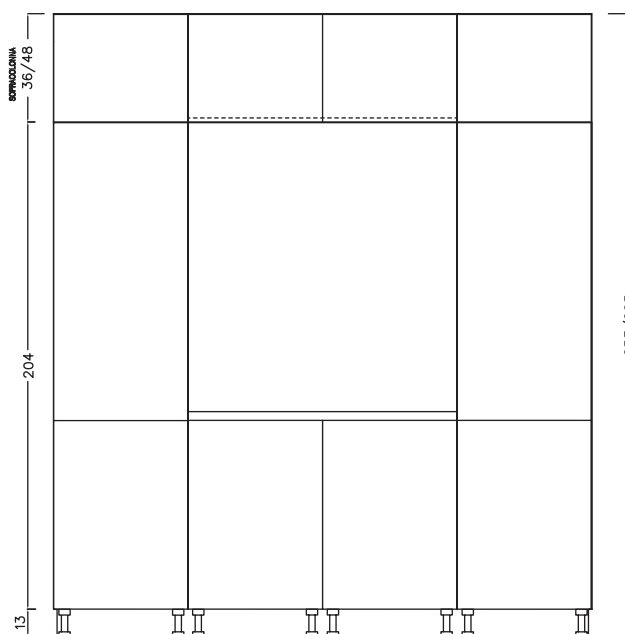

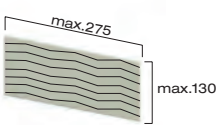
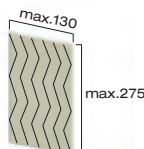

# FIANCHI DI FINITURA

FINISHING SIDE PANELS

	COD.	JEY K24				
<p><b>maggiorazione per fianchi di struttura come anta (cadauno)</b>  <b>N.B.: finiture legno con venatura verticale</b>                      surcharge for carcass sides same finish as door (each)                      Note: for wooden finish with vertical grain</p> 						
	<b>PENSILE</b> WALL UNIT					
	36x31	+26				
	48x31	+28				
	60x31	+31				
	72x31	+37				
	96x31	+43				
	120x31	+45				
	<b>BASE</b> BASE UNIT					
	36X48	+29				
	48X48	+31				
	36x57,5	+29				
	48x57,5	+31				
	60x57,5	+34				
	72x57,5	+40				
	<b>COLONNA</b> COLUMN					
	132x31	+48				
	204x31	+64				
	228x31	+68				
	96x57,5	+44				
132x57,5	+48					
204x57,5	+64					
228x57,5	+68					
<p><b>pannello di finitura SP. 2,2 finitura come anta venature orizzontali per finiture legno</b>  <b>4 lati squadrate e bordati</b>  <b>N.B.: quantità minima fatturabile 0,5 mq</b>                      finishing panel TH. 2,2 same finish as door                      horizontal grains for wooden finishes                      4 sides squared and rimmed                      Note: minimum invoiceable quantity 0,5 m<sup>2</sup></p> 						
	sp.2,2 al mq th. 2,2 per m <sup>2</sup>	094510	129			
<p><b>pannello di finitura SP. 2,2 finitura come anta venature verticale per finiture legno</b>  <b>4 lati squadrate e bordati</b>  <b>N.B.: quantità minima fatturabile 0,5 mq</b>                      finishing panel TH. 2,2 same finish as door                      vertical grains for wooden finishes                      4 sides squared and rimmed                      Note: minimum invoiceable quantity 0,5 m<sup>2</sup></p> 						
	sp.2,2 al mq th. 2,2 per m <sup>2</sup>	094510V	129			



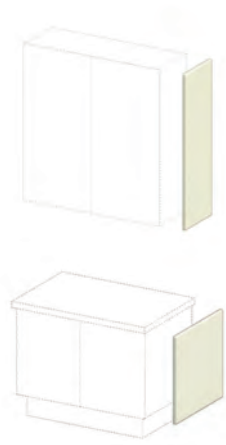

# ANTE DI FINITURA







## FINISHING DOORS

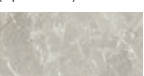

	COD.	JEY					
<p><b>ante di finitura laterali sp. 2,2</b>  <b>4 lati squadrati e bordati, finiture</b>  <b>legno con venature orizzontali</b>                      lateral finishing doors th. 2,2                      4 sides squared and rimmed                      with horizontal grains for wooden finish</p> 		K24					
	<b>PENSILE</b>						
	WALL UNIT						
	H 36 (35,7x33,4)	1K244045	33				
	H 48 (47,7x33,4)	1K244046	33				
	H 60 (59,7x33,4)	1K244047	33				
	H 72 (71,7x33,4)	1K24405	33				
	H 96 (95,7x33,4)	1K24406	41				
	H 120 (119,7x33,4)	1K24407	54				
	<b>BASE</b>						
	BASE UNIT						
	H 49 (35,7x59,9)	1K24395	62				
	H 61 (47,7x59,9)	1K24396	63				
	H 73 (59,7x59,9)	1K24398	65				
	H 85 (71,7x59,9)	1K24400	65				
	<b>ISOLA</b>						
	ISLAND						
	H 73 (59,7x62,1)	1K24402	67				
	H 85 (71,7x62,1)	1K24403	67				
	<b>COLONNA</b>						
	COLUMN						
	H 217 (203,7x33,4)	1K244112	85				
	H 241 (227,7x33,4)	1K244122	98				
	H 109 (95,7x59,9)	1K24409	73				
	H 145 (131,7x59,9)	1K24410	97				
	H 217 (203,7x59,9)	1K24411	145				
	H 241 (227,7x59,9)	1K24412	164				
<p><b>ante di finitura posteriori sp.2,2</b>  <b>per basi uso penisola-isola</b>  <b>profilo "A" come anta</b>                      rear finishing doors th. 2,2                      for base units used as                      peninsula-island                      "A" profile same as door</p> 							
	<b>BASE</b>						
	BASE UNIT						
	L 45 (59,7x44,6)	1K24424	82				
	L 60 (59,7x59,6)	1K24426	88				
	L 90 (59,7x89,6)	1K24428	114				
	L 30 (71,7x29,6)	1K24430	81				
	L 40 (71,7x39,6)	1K24432	87				
	L 45 (71,7x44,6)	1K24434	89				
	L 60 (71,7x59,6)	1K24436	98				
	L 90 (71,7x89,6)	1K24440	112				
	<b>BASE ANGOLO</b>						
CORNER BASE UNIT							
L 65 (71,7x64,6)	1K24438	99					

# MENSOLE

## SHELVES

	COD.	€		COD.	€						
<p><b>mensola sp. 3,8 in nobilitato colori come strutture</b>  <b>L max cm 400</b>                      laminate shelf Th. 3.8 carcasses colours                      max. length 400 cm</p>  <div style="display: flex; flex-wrap: wrap; justify-content: space-around;"> <div style="width: 30%; text-align: center;">                       bianco (opz.001)                      white (opt.001)                 </div> <div style="width: 30%; text-align: center;">                       argilla (opz.9690)                      clay (opt.9690)                 </div> <div style="width: 30%; text-align: center;">                       conchiglia (opz.8910)                      shell (opt.8910)                 </div> <div style="width: 30%; text-align: center;">                       fango (opz.8860)                      mud (opt.8860)                 </div> <div style="width: 30%; text-align: center;">                       lavagna (opz.9620)                      slate grey (opt.9620)                 </div> <div style="width: 30%; text-align: center;">                       visone (opz.948M)                      mink (opt.948M)                 </div> </div> <p style="text-align: right;"><b>prezzi al ml</b> prices per lm</p> <table style="width: 100%; border-collapse: collapse;"> <tr> <td style="text-align: right;"><b>P 31</b></td> <td style="text-align: center;">091523</td> <td style="text-align: center;">75</td> </tr> <tr> <td style="text-align: right;"><b>P 61</b></td> <td style="text-align: center;">091560</td> <td style="text-align: center;">98</td> </tr> </table>	<b>P 31</b>	091523	75	<b>P 61</b>	091560	98					
<b>P 31</b>	091523	75									
<b>P 61</b>	091560	98									
<p><b>mensola sp. 3,8 finiture come anta</b>  <b>L max cm 275</b>                      laminate shelf Th. 3.8 same finish as door                      max. length 275 cm</p>  <div style="display: flex; flex-wrap: wrap; justify-content: space-around;"> <div style="width: 30%; text-align: center;">                       rovere silver (opz.5306)                      silver oak (opt.5306)                 </div> <div style="width: 30%; text-align: center;">                       rovere diamond (opz.5307)                      diamond oak (opt.5307)                 </div> <div style="width: 30%; text-align: center;">                       rovere tabia (opz.5309)                      tabia oak (opt.5309)                 </div> <div style="width: 30%; text-align: center;">                       rovere ortisei (opz.5305)                      ortisei oak (opt.5305)                 </div> <div style="width: 30%; text-align: center;">                       black (opz.7863)                      black (opt.7863)                 </div> <div style="width: 30%; text-align: center;">                       white (opz.7448)                      white (opt.7448)                 </div> <div style="width: 30%; text-align: center;">                       grigio agata (opz.9623)                      agata grey (opt.9623)                 </div> <div style="width: 30%; text-align: center;">                       bianco assoluto (opz.7441)                      absolute white (opt.7441)                 </div> <div style="width: 30%; text-align: center;">                       grigio inox (opz.9624)                      stainless steel grey (opt.9624)                 </div> <div style="width: 30%; text-align: center;">                       rosso cardinale (opz.8123)                      cardinal red (opt.8123)                 </div> <div style="width: 30%; text-align: center;">                       trani (opz.7704)                      trani (opt.7704)                 </div> </div> <p style="text-align: right;"><b>prezzi al ml</b> prices per lm</p> <table style="width: 100%; border-collapse: collapse;"> <tr> <td style="text-align: right;"><b>P 31</b></td> <td style="text-align: center;">091523</td> <td style="text-align: center;">128</td> </tr> <tr> <td style="text-align: right;"><b>P 61</b></td> <td style="text-align: center;">091560</td> <td style="text-align: center;">169</td> </tr> </table>	<b>P 31</b>	091523	128	<b>P 61</b>	091560	169					
<b>P 31</b>	091523	128									
<b>P 61</b>	091560	169									

	COD.	JEY				
 <p><b>base per forno H 85</b>  <b>staffe inferiori</b>  <b>fianco H 72 P 61</b>                      oven base unit H 85                      lower brackets                      side H 72 D 61</p> <p>68,5-72,7</p>		K24				
L 76,2	USABF7277	173				
 <p><b>base per forno H 89,2</b>  <b>1 fascia superiore</b>  <b>staffe inferiori</b>  <b>fianco H 76,2 P 61</b>                      oven base unit H 89,2                      1 upper panel                      lower brackets                      side H 76,2 D 61</p> <p>71,7-73,9</p>						
L 76,2	USABF7777	202				
 <p><b>colonna per doppio forno H 217</b>  <b>1 anta ribalta TIP-ON H 36</b>  <b>1 fascia superiore</b>  <b>1 ripiano smontato</b>  <b>1 cestone H 36</b>                      double oven column H 217                      1 flap door TIP-ON H 36                      1 upper band                      1 disassembled shelf                      1 deep drawer H 36</p> <p>114-132</p>						
L 76,2	USACF204C3	622				
 <p><b>colonna per doppio forno H 217</b>  <b>1 anta ribalta TIP-ON H 48</b>  <b>1 fascia superiore</b>  <b>1 ripiano smontato</b>  <b>1 cestone H 36</b>                      double oven column H 217                      1 flap door TIP-ON H 48                      1 upper band                      1 disassembled shelf                      1 deep drawer H 36</p> <p>102-120</p>						
L 76,2	USACF204C4	631				
 <p><b>colonna per doppio forno H 217</b>  <b>1 anta ribalta TIP-ON H 60</b>  <b>1 fascia superiore</b>  <b>1 ripiano smontato</b>  <b>1 cestone H 36</b>                      double oven column H 217                      1 flap door TIP-ON H 60                      1 upper band                      1 disassembled shelf                      1 deep drawer H 36</p> <p>90-108</p>						
L 76,2	USACF204C6	712				
 <p><b>colonna per doppio forno H 241</b>  <b>1 anta ribalta TIP-ON H 60</b>  <b>1 fascia superiore</b>  <b>1 ripiano smontato</b>  <b>1 cestone H 36</b>                      double oven column H 241                      1 flap door TIP-ON H 60                      1 upper band                      1 disassembled shelf                      1 deep drawer H 36</p> <p>114-132</p>						
L 76,2	USACF228C6	725				

	COD.	JEY K24				
 <p><b>sopracolonna H 36</b> top columns H 36</p>						
	L 76,2	USASC3677C	250			
	L 91,4	USASC3692C	287			
 <p><b>sopracolonna H 48</b> <b>1 ripiano</b> top columns H 48 1 shelf</p>						
	L 76,2	USASC4877C	308			
	L 91,4	USASC4892C	342			
 <p><b>sopracolonna H 60</b> <b>1 ripiano</b> top columns H 60 1 shelf</p>						
	L 76,2	USASC6077C	384			



# LIVING







Spazi coordinati per avere un solo ambiente per cucinare, ricevere gli amici, pranzare e rilassarsi è una soluzione al desiderio di vivere la casa più liberamente, secondo stili di vita contemporanei, integrando cucina e living all'insegna di un nuovo linguaggio progettuale.

Coordinated spaces that create a single environment in which to cook, receive friends and relax is a solution that allows you to experience the home more freely.

In line with contemporary lifestyles, this solution integrates the kitchen and living area to create a new design language









**Per la modulistica completa dei pensili P 33,4 consultare la sezione "Pensili"**  
 For complete modularity of wall units D 33,4 see "Wall units section"

	COD.	JEY K24				
 <p><b>pensile H 36</b>                      apertura a vasistas con push-pull                      wall unit H 36                      flap door with push-pull opening</p>	L 60	E2106600	165			
	L 90	E2106900	246			
	L 120	E2107200	300			
 <p><b>pensile H 48</b>                      apertura a vasistas con push-pull                      wall unit H 48                      flap door with push-pull opening</p>	L 60	E2123600	247			
	L 90	E2123900	269			
	L 120	E2124200	329			
 <p><b>pensile H 120</b>                      2 ante H 60                      wall unit H 120                      2 doors H 60</p>	L 60	E2140601/2	225			
 <p><b>pensile H 36</b>                      anta vetro                      apertura a vasistas con push-pull                      wall unit H 36                      glass door                      flap door with push-pull opening</p>	L 60	E1107600	296			
	L 90	E1107900	405			
 <p><b>pensile H 48</b>                      anta vetro                      apertura a vasistas con push-pull                      wall unit H 48                      glass door                      flap door with push-pull opening</p>	L 60	E1125600	381			
	L 90	E1125900	449			
 <p><b>mensola in appoggio per pensile</b>                      in melaminico finitura come anta                      L max.275                      support shelf for wall unit                      melamine same finish as door                      max.lenght 275</p>	P 33,4 sp.2,2 al ml D 33,4 th.2,2 per ml	TLE223	44			
 <p><b>maggiorazione per fianchi di struttura</b>                      come anta (cadauno)                      surcharge for carcass sides same finish as door (each)</p>	<b>PENSILI</b> WALL UNITS					
	36x31		+26			
	48x31		+28			
	120x31		+45			

# BASI LIVING con piedi H 2,5

H 20,5 - 26,5 - 38,5 P 50,4





LIVING AREA BASE UNITS with feet H 2,5

<b>LE BASI NON SONO COMPRENSIVE DI TOP</b> THE BASE UNITS DO NOT INCLUDE THE TOPS		COD.	<b>JEY</b> K24					
	<b>base H 20,5</b> <b>1 cassetto H 18</b> base unit H 20,5 1 drawer H 18	L 45	EBL03450	166				
	L 60	EBL03600	184					
	L 90	EBL03900	215					
	L 120	EBL04200	283					
	<b>base H 26,5</b> <b>1 cassetto H 24</b> base unit H 26,5 1 drawer H 24	L 45	EBL13450	167				
	L 60	EBL13600	188					
	L 90	EBL13900	246					
	L 120	EBL14200	294					
	<b>base H 38,5</b> <b>1 anta H 36</b> base unit H 38,5 1 door H 36	L 45	EBL21451/2	147				
	L 60	EBL21601/2	157					
	<b>base H 38,5</b> <b>2 ante H 36</b> base unit H 38,5 2 doors H 36	L 90	EBL21900	225				
	L 120	EBL22200	263					
	<b>base H 38,5</b> <b>1 cestone H 36</b> base unit H 38,5 1 deep drawer H 36	L 45	EBL25450	185				
	L 60	EBL25600	212					
	L 90	EBL25900	237					
	L 120	EBL26200	327					
	<b>base H 38,5</b> <b>2 cassetti H 18</b> base unit H 38,5 2 drawers H 18	L 45	EBL23450	242				
	L 60	EBL23600	257					
	L 90	EBL23900	302					
	L 120	EBL24200	409					

# BASI LIVING con piedi H 2,5

H 50,5 P 50,4

LIVING AREA BASE UNITS with feet H 2,5

LE BASI NON SONO COMPRENSIVE DI TOP THE BASE UNITS DO NOT INCLUDE THE TOPS		COD.	JEY K24					
 <p><b>base H 50,5</b> <b>1 anta H 48</b> base unit H 50,5 1 door H 48</p>	L 45	EBL31451/2	159					
	L 60	EBL31601/2	171					
 <p><b>base H 50,5</b> <b>2 ante H 48</b> base unit H 50,5 2 doors H 48</p>	L 90	EBL31900	251					
	L 120	EBL32200	301					
 <p><b>base H 50,5</b> <b>1 cestone H 48</b> base unit H 50,5 1 deep drawer H 48</p>	L 45	EBL35450	197					
	L 60	EBL35600	222					
	L 90	EBL35900	247					
	L 120	EBL36200	327					
 <p><b>top living</b> <b>melaminico come anta</b> <b>L.max 275</b> living worktop melamine same as door max.length 275</p>								
		P 50,4 sp.2,2 al ml D 50,4 th.2,2 per ml	TLE225	65				
 <p><b>maggiorazione per fianchi di struttura</b> <b>come anta (cadauno)</b> surcharge for carcass sides same finish as door (each)</p>								
		<b>BASI</b>						
		BASE UNITS						
		18x48		+29				
		24x48		+29				
	36x48		+29					
	48x48		+31					

**LE BASI NON SONO COMPRENSIVE DI TOP**  
THE BASE UNITS DO NOT INCLUDE THE TOPS

COD.

**JEY**  
K24

**base H 36**  
**1 anta**  
base unit H 36  
1 door



L 45  
L 60

EBL71451/2  
EBL71601/2

134  
143

**base H 36**  
**2 ante**  
base unit H 36  
2 doors



L 90  
L 120

EBL71900  
EBL72200

204  
232

**base H 36**  
**1 cestone**  
base H 36  
1 deep drawer



L 45  
L 60  
L 90  
L 120

EBL75450  
EBL75600  
EBL75900  
EBL76200

184  
205  
236  
322

**base H 48**  
**1 anta**  
base unit H 48  
1 door



L 45  
L 60

EBL81451/2  
EBL81601/2

169  
181

**base H 48**  
**2 ante**  
base unit H 48  
2 doors



L 90  
L 120

EBL81900  
EBL82200

258  
304

**base H 48**  
**1 cestone**  
base unit H 48  
1 deep drawer



L 45  
L 60  
L 90  
L 120

EBL85450  
EBL85600  
EBL85900  
EBL86200







206  
231  
256  
323

# BASI LIVING CON ZOCCOLO

H 31 - 37 - 49 P 59,9

LIVING AREA BASE UNITS WITH PLINTH





**LE BASI NON SONO COMPRENSIVE DI TOP**  
THE BASE UNITS DO NOT INCLUDE THE TOPS

		COD.	JEY K24				
 <p><b>base H 31</b> <b>1 cassetto H 18</b> base unit H 31 1 drawer H 18</p>	L 45	E4023450	140				
	L 60	E4023600	156				
	L 90	E4023900	198				
	L 120	E4024200	259				
 <p><b>base H 37</b> <b>1 cassetto H 24</b> base unit H 37 1 drawer H 24</p>	L 45	E4025450	152				
	L 60	E4025600	168				
	L 90	E4025900	233				
	L 120	E4026200	284				
 <p><b>base H 49</b> <b>1 anta H 36</b> base unit H 49 1 door H 36</p>	L 45	E4026451/2	134				
	L 60	E4026601/2	147				
 <p><b>base H 49</b> <b>2 ante H 36</b> base unit H 49 2 doors H 36</p>	L 90	E4026900	218				
	L 120	E4027200	247				
 <p><b>base H 49</b> <b>1 cestone H 36</b> base unit H 49 1 deep drawer H 36</p>	L 45	E4204450	172				
	L 60	E4204600	187				
	L 90	E4204900	229				
	L 120	E4205200	312				
 <p><b>base H 49</b> <b>2 cassetti H 18</b> base unit H 49 2 drawers H 18</p>	L 45	E4204460	220				
	L 60	E4204610	238				
	L 90	E4204910	286				
	L 120	E4205210	388				

# BASI LIVING CON ZOCCOLO

H 61 P 59,9

LIVING AREA BASE UNITS WITH PLINTH

LE BASI NON SONO COMPRENSIVE DI TOP THE BASE UNITS DO NOT INCLUDE THE TOPS		COD.	JEY K24					
 <p><b>base H 61 1 anta H 48</b> base unit H 61 1 door H 48</p>	L 45	E4028451/2	139					
	L 60	E4028601/2	153					
 <p><b>base H 61 2 ante H 48</b> base unit H 61 2 doors H 48</p>	L 90	E4028900	236					
	L 120	E4029200	284					
 <p><b>base H 61 1 cestone H 48</b> base unit H 61 1 deep drawer H 48</p>	L 45	E4205450	179					
	L 60	E4205600	194					
	L 90	E4205900	238					
	L 120	E4206200	313					
 <p><b>top living melaminico come anta L.max 275</b> living worktop melamine same as door max.length 275</p>								
		P 59,9 sp.2,2 al ml D 59,9 th.2,2 per ml	TLE226	78				
 <p><b>maggiorazione per fianchi di struttura come anta (cadauno)</b> surcharge for carcass sides same finish as door (each)</p>								
		<b>BASI BASE UNITS</b>						
		18x57,5		+29				
		24x57,5		+29				
		36x57,5		+29				
	48x57,5		+31					





# LIVING K24-1



ANTE  
doors

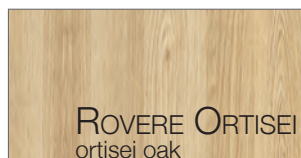

ELEMENTI A GIORNO  
open units



STRUTTURE  
carcasses

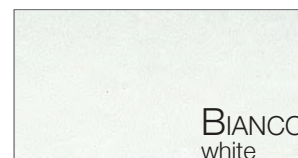

# LIVING K24-1

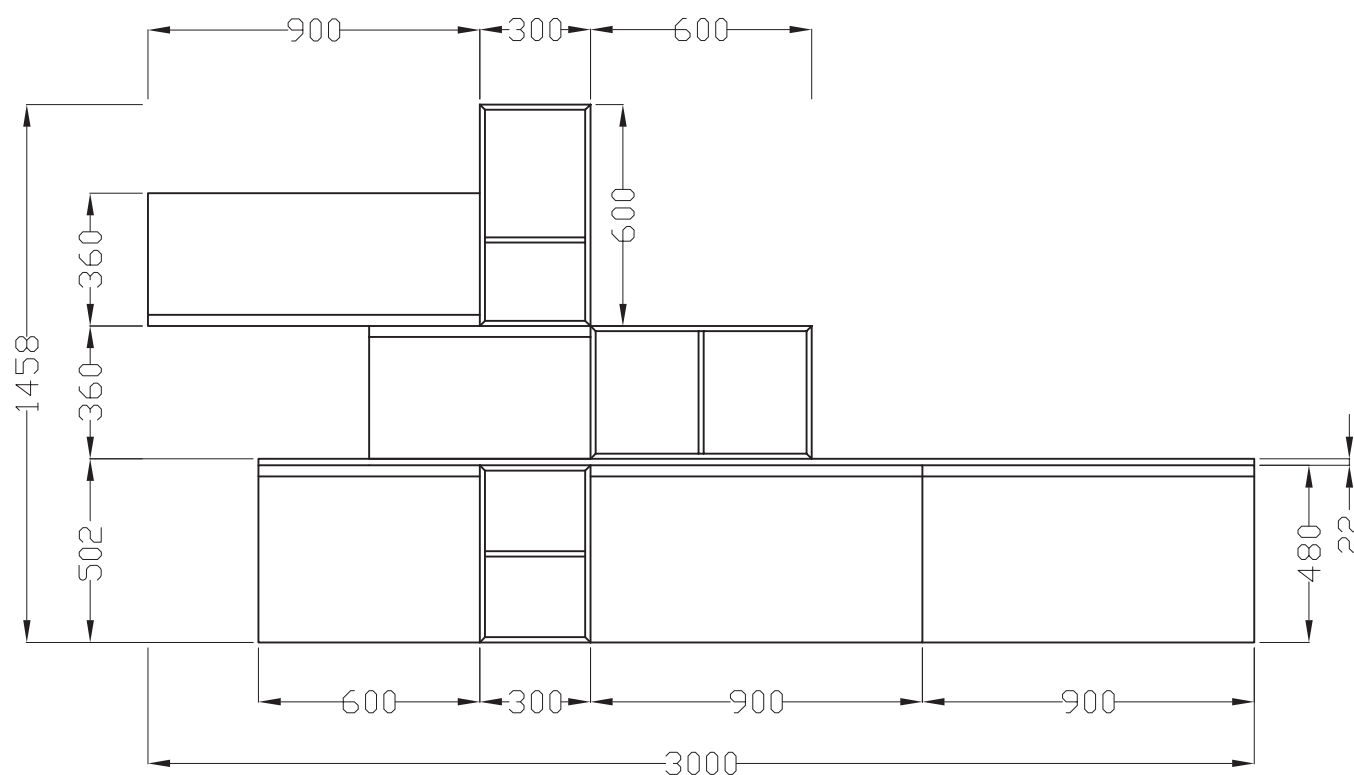

NR. ELEMENTI	DESCRIZIONE	CODICE	€ cad.
1	Pensile L 90 H 36 P 33,4 ribalta 1 fianco come anta	E2100900	189
1	Elemento a giorno L 30 H 60 P 31 in polimerico 2 vani	E7700733	184
1	Pensile L 60 H 36 P 33,4 apertura vasistas 1 fianco come anta	E2106600	191
1	Elemento a giorno L 60 H 36 P 31 in polimerico 2 vani	E7700711	191
1	Pensile L 60 H 48 P 33,4 apertura vasistas 1 fianco come anta	E2123600	275
1	Elemento a giorno L 30 H 48 P 31 in polimerico 2 vani	E7700732	172
1	Pensile L 90 H 48 P 33,4 apertura vasistas 1 fianco come anta	E2123900	297
1	Pensile L 90 H 48 P 33,4 apertura vasistas	E2123900	269
1	Top L 270 H 2,2 P 33,4 in melaminico come anta	al ml TLE223	44
3	Asta appendipensili ml 2	08610501	9
<b>TOTALE</b>			<b>1.914</b>
No. of ELEMENTS	DESCRIPTION	CODE	€ each
1	Wall unit W 90 H 36 D 33,4 flap door 1 side same as door	E2100900	189
1	Polymeric open unit W 30 H 60 D 31 2 compartments	E7700733	184
1	Wall unit W 60 H 36 D 33,4 flap door opening 1 side same as door	E2106600	191
1	Polymeric open unit W 60 H 36 D 31 2 compartments	E7700711	191
1	Wall unit W 60 H 48 D 33,4 flap door opening 1 side same as door	E2123600	275
1	Polymeric open unit W 30 H 48 D 31 2 compartments	E7700732	172
1	Wall unit W 90 H 48 D 33,4 flap door opening 1 side same as door	E2123900	297
1	Wall unit W 90 H 48 D 33,4 flap door opening	E2123900	269
1	Melamine worktop W 270 H 2,2 D 33,4 same as door	per lm TLE223	44
3	Wall unit fixing strip lm 2	08610501	9
<b>TOTAL</b>			<b>1.914</b>

# LIVING K24-2



ANTE  
doors

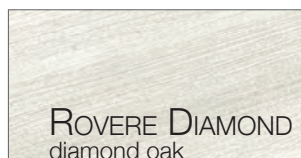

ELEMENTI A GIORNO  
open units



STRUTTURE  
carcasses

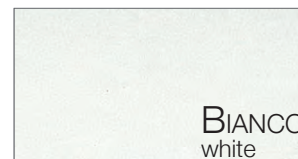
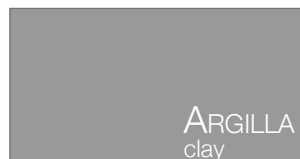

# LIVING K24-2

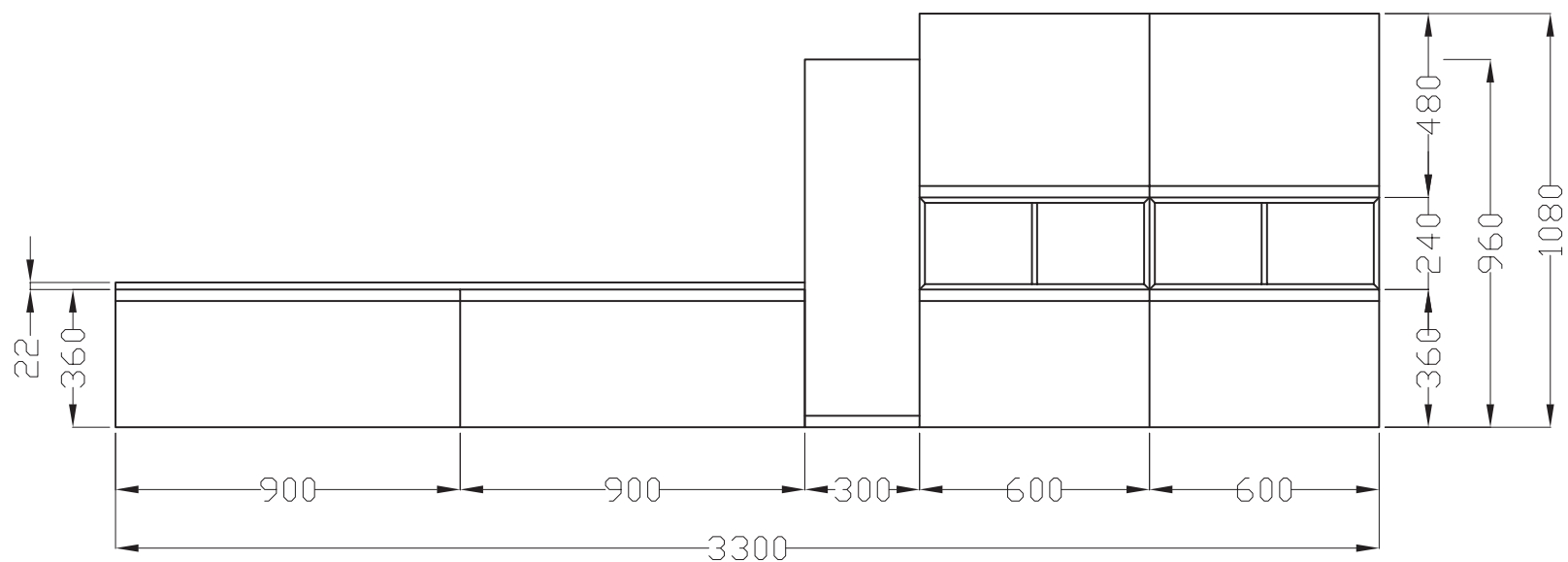

NR. ELEMENTI	DESCRIZIONE	CODICE	€ cad.
1	Pensile L 90 H 36 P 33,4 apertura vasistas push-pull, 1 fianco come anta	E2106900	272
1	Pensile L 90 H 36 P 33,4 apertura vasistas push-pull	E2106900	246
1	Pensile L 60 H 36 P 33,4 apertura vasistas push-pull	E2106600	165
1	Pensile L 60 H 36 P 33,4 apertura vasistas push-pull, 1 fianco come anta	E2106600	191
1	Pensile L 30 H 96 P 33,4 apertura push-pull 1 fianco come anta	E2020301/2	186
1	Pensile L 60 H 48 P 33,4 1 fianco come anta	E2040601/2	153
1	Pensile L 60 H 48 P 33,4 1 fianco come anta	E2040601/2	153
2	Elemento a giorno L 60 H 24 P 31 in polimerico 2 vani	E7700706	172
1	Top L 180 H 2,2 P 33,4 in melaminico come anta	al ml TLE223	44
1	Top L 120 H 2,2 P 33,4 in melaminico come anta	al ml TLE223	44
3	Asta appendipensili ml 2	08610501	9
<b>TOTALE</b>			<b>1.869</b>
No. of ELEMENTS	DESCRIPTION	CODE	€ each
1	Wall unit W 90 H 36 D 33,4 flap door with push pull opening, 1 side same as door	E2106900	272
1	Wall unit W 90 H 36 D 33,4 flap door with push pull opening	E2106900	246
1	Wall unit W 60 H 36 D 33,4 flap door with push pull opening	E2106600	165
1	Wall unit W 60 H 36 D 33,4 flap door with push pull opening, 1 side same as door	E2106600	191
1	Wall unit W 30 H 96 D 33,4 push-pull opening 1 side same as door	E2020301/2	186
1	Wall unit W 60 H 48 D 33,4 1 side same as door	E2040601/2	153
1	Wall unit W 60 H 48 D 33,4 1 side same as door	E2040601/2	153
2	Polymeric open unit W 60 H 24 D 31 2 compartments	E7700706	172
1	Melamine worktop W 180 H 2,2 D 33,4 same as door	per lm TLE223	44
1	Melamine worktop W 120 H 2,2 D 33,4 same as door	per lm TLE223	44
3	Wall unit fixing strip lm 2	08610501	9
<b>TOTAL</b>			<b>1.869</b>

# LIVING K24-3



ANTE  
doors

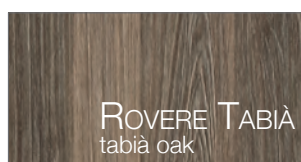

ELEMENTI A GIORNO  
open units



STRUTTURE  
carcasses

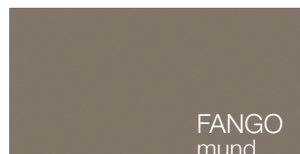

# LIVING K24-3

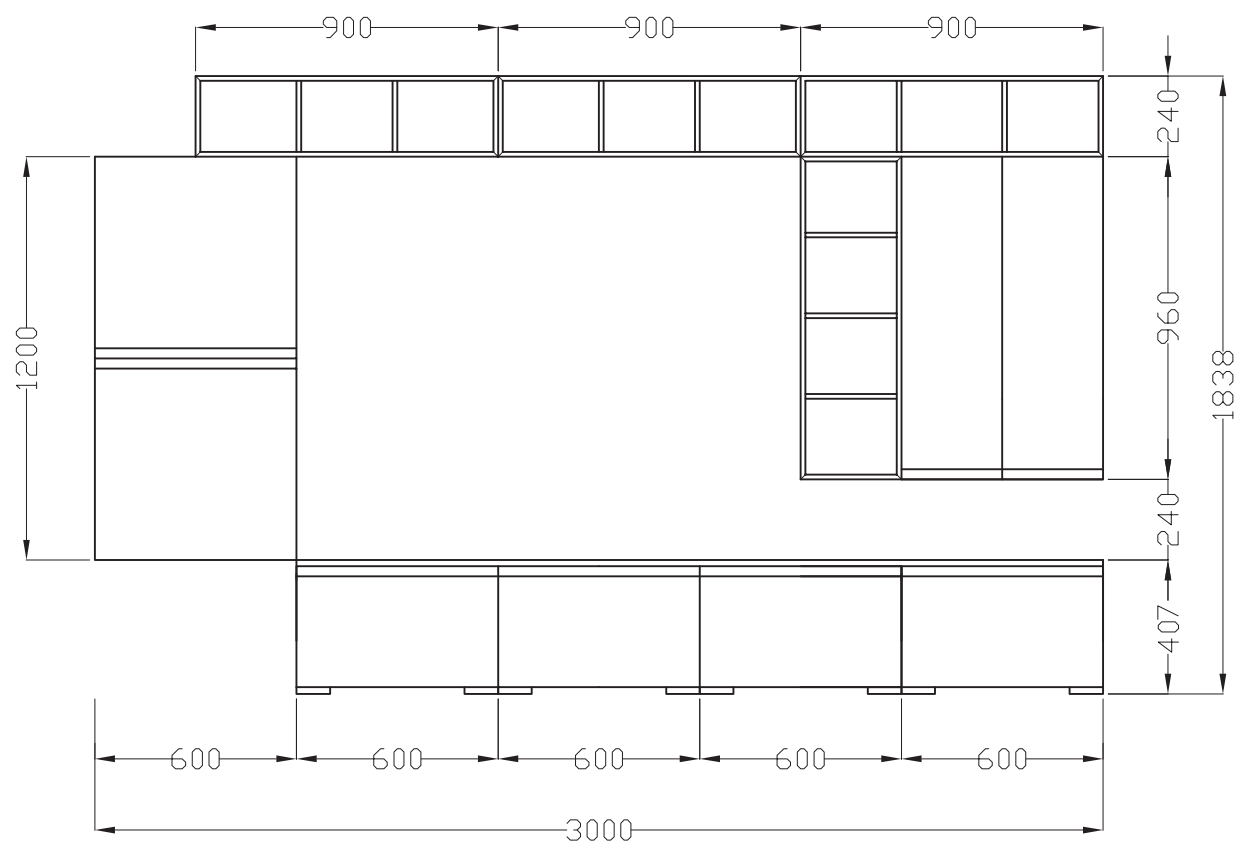

NR. ELEMENTI	DESCRIZIONE	CODICE	€ cad.
3	Elemento a giorno 3 vani L 90 H 24 P 31 laccato opaco	E7701707	287
1	Pensile L 60 H 120 P 33,4 2 ante, fianchi come anta	E2140601/2	315
1	Elemento a giorno 4 vani L 30 H 96 P 31 laccato opaco	E7701735	337
1	Pensile L 30 H 96 P 33,4	E2020302	143
1	Pensile L 30 H 96 P 33,4 1 fianco come anta	E2020301	186
2	Base living L 60 H 38,5 P 50,4 cestone	EBL25600	212
2	Base living L 60 H 38,5 P 50,4 cestone, 1 fianco come anta	EBL25600	241
1	Top L 240 H 2,2 P 50,4 in melaminico come anta	al ml TLE225	65
1	Asta appendipensili ml 2	08610501	9
<b>TOTALE</b>			<b>2.913</b>
No. of ELEMENTS	DESCRIPTION	CODE	€ each
3	Matt lacquered open unit with 3 compartments W 90 H 24 D 31	E7701707	287
1	Wall unit W 60 H 120 D 33,4 2 doors, sides same as door	E2140601/2	315
1	Matt lacquered open unit with 4 compartments W 30 H 96 D 31	E7701735	337
1	Wall unit W 30 H 96 D 33,4	E2020302	143
1	Wall unit W 30 H 96 D 33,4 1 side same as door	E2020301	186
2	Living base unit W 60 H 38,5 D 50,4 deep drawer	EBL25600	212
2	Living base unit W 60 H 38,5 D 50,4 deep drawer, 1 side same as doors	EBL25600	241
1	Melamine worktop W 240 H 2,2 D 50,4	per lm TLE225	65
1	Wall unit fixing strip lm 2	08610501	9
<b>TOTAL</b>			<b>2.913</b>

# LIVING K24-4



ANTE  
doors

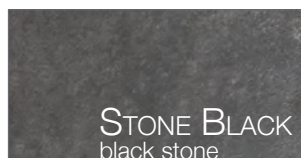

ELEMENTI A GIORNO  
open units



STRUTTURE  
carcasses

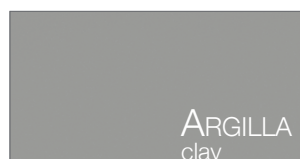

# LIVING K24-4

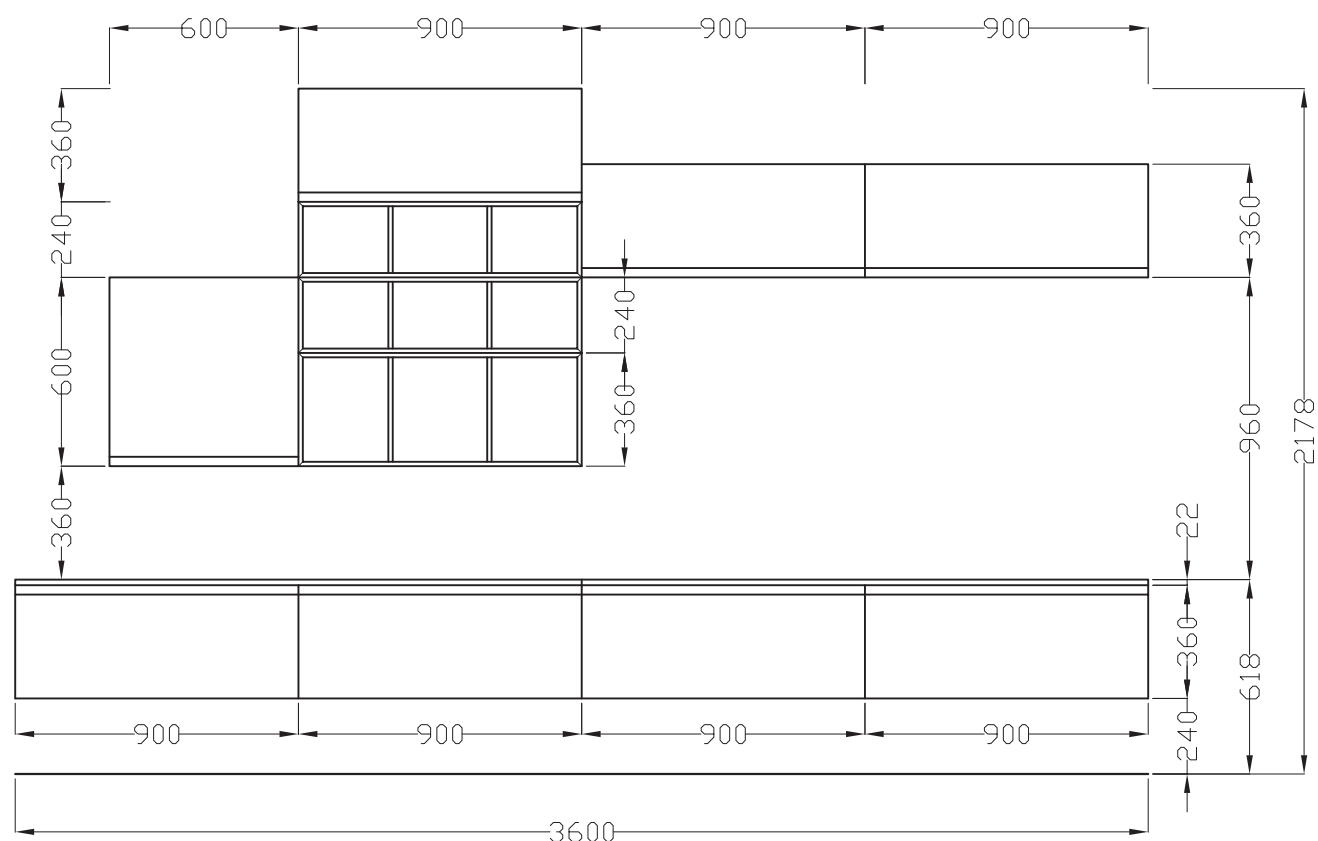

NR. ELEMENTI	DESCRIZIONE	CODICE	€ cad.
1	Pensile L 90 H 36 P 33,4 anta ribalta, fianchi come anta	E2100900	215
1	Pensile L 90 H 36 P 33,4 anta ribalta	E2100900	163
1	Pensile L 90 H 36 P 33,4 anta ribalta, 1 fianco come anta	E2100900	189
2	Elemento a giorno 3 vani L 90 H 24 P 31 laccato opaco	E7701707	287
1	Pensile L 60 H 60 P 33,4 1 fianco come anta	E2060601/2	163
1	Elemento a giorno 3 vani L 90 H 36 P 31 laccato opaco	E7700712	256
2	Base living sospesa L 90 H 36 P 50,4 cestone	EBL75900	236
2	Base living sospesa L 90 H 36 P 50,4 cestone, 1 fianco come anta	EBL75900	265
2	Top L 180 H 2,2 P 50,4 in melaminico come anta	al ml TLE225	65
2	Asta appendispensili ml 2	08610501	9
<b>TOTALE</b>			<b>2.710</b>
No. of ELEMENTS	DESCRIPTION	CODE	€ each
1	Wall unit W 90 H 36 D 33,4 flap door sides same as door	E2100900	215
1	Wall unit W 90 H 36 D 33,4 flap door	E2100900	163
1	Wall unit W 90 H 36 D 33,4 flap door, 1 side same as door	E2100900	189
2	Matt lacquered open unit with 3 compartments W 90 H 24 D 31	E7701707	287
1	Wall unit W 60 H 60 D 33,4 flap door, 1 side same as door	E2060601/2	163
1	Matt lacquered open unit with 3 compartments W 90 H 36 D 31	E7700712	256
2	Suspend living base unit W 90 H 36 D 50,4 deep drawer	EBL75900	236
2	Suspend living base unit W 90 H 36 D 50,4 deep drawer, 1 side same as door	EBL75900	265
2	Melamine worktop W 180 H 2,2 D 50,4 same as door	per lm TLE225	65
2	Wall unit fixing strip lm 2	08610501	9
<b>TOTAL</b>			<b>2.710</b>



# LIVING K24-5



ANTE  
doors



GRIGIO AGATA  
agate grey



STONE WHITE  
white stone

STRUTTURE  
carcasses

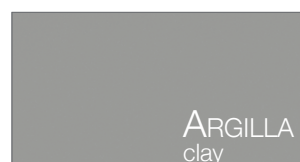

ARGILLA  
clay



BIANCO  
white

# LIVING K24-5

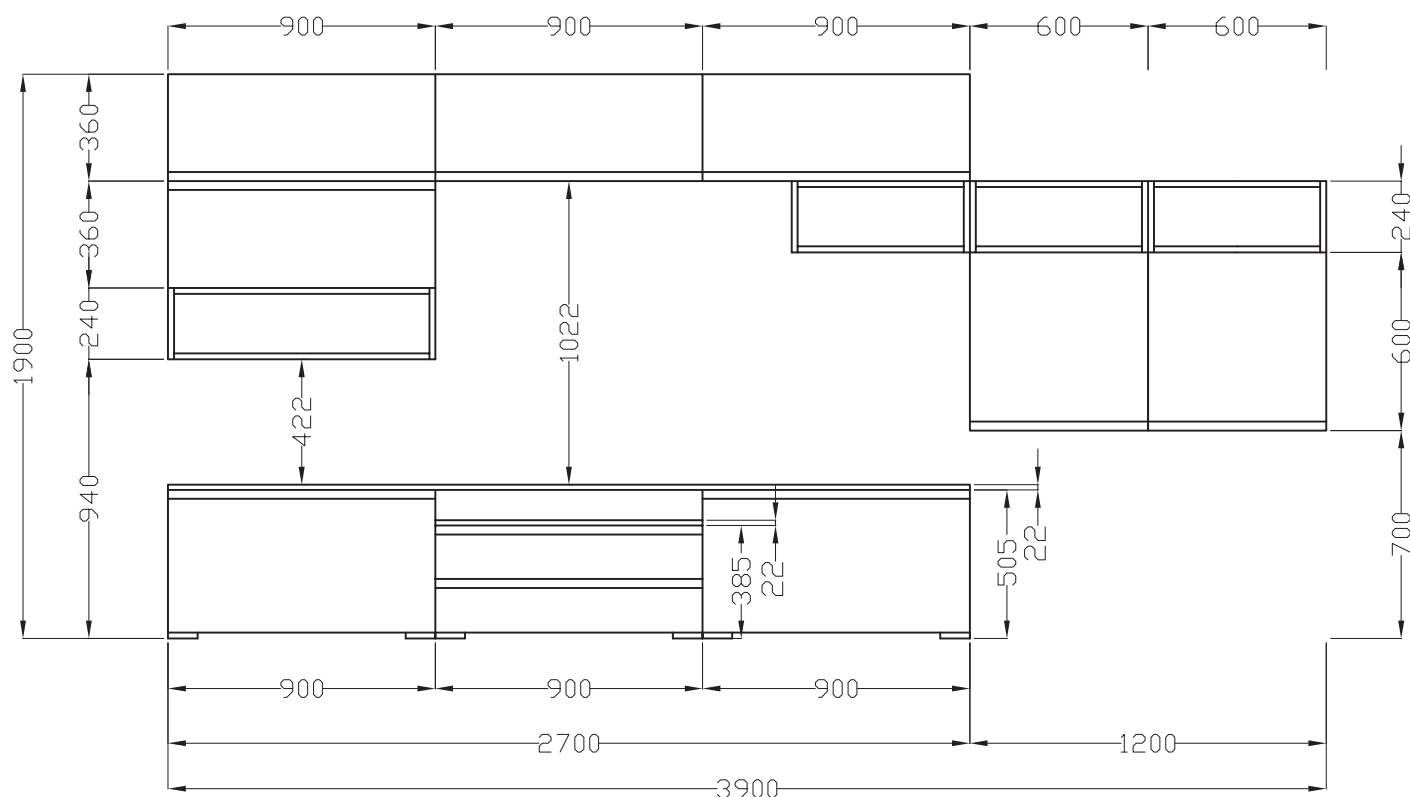

NR. ELEMENTI	DESCRIZIONE	CODICE	€ cad.
2	Pensile L 90 H 36 P 33,4 anta ribalta, 1 fianco come anta	E2100900	189
1	Pensile L 90 H 36 P 33,4 anta ribalta	E2100900	163
1	Pensile L 90 H 36 P 33,4 apertura vasistas, fianchi come anta	E2106900	298
1	Elemento a giorno L 90 H 24 in metallo	E7861090	285
3	Elemento a giorno L 60 H 24 in metallo	E7861060	245
2	Pensile L 60 H 60 P 33,4 1 fianco come anta	E2060601/2	163
2	Base living L 90 H 50,5 P 50,4 cestone, fianchi come anta	EBL35900	309
1	Base living L 90 H 38,5 P 50,4 2 cassetti	EBL23900	302
1	Top L 270 H 2,2 P 50,4 in melaminico come anta	al ml TLE225	65
1	Top L 90 H 2,2 P 50,4 in melaminico come anta	al ml TLE225	65
2	Asta appendipensili ml 2	08610501	9
<b>TOTALE</b>			<b>3.357</b>
No. of ELEMENTS	DESCRIPTION	CODE	€ each
2	Wall unit W 90 H 36 D 33,4 flap door, 1 side same as door	E2100900	189
1	Wall unit W 90 H 36 D 33,4 flap door	E2100900	163
1	Wall unit W 90 H 36 D 33,4 flap door opening, sides same as door	E2106900	298
1	Metal open units L 90 H 24	E7861090	285
3	Metal open units L 60 H 24	E7861060	245
2	Wall unit W 60 H 60 D 33,4 1 side same as door	E2060601/2	163
2	Living base unit W 90 H 50,5 D 50,4 deep drawer, sides same as door	EBL35900	309
1	Living base unit W 90 H 38,5 D 50,4 2 drawers	EBL23900	302
1	Melamine worktop W 270 H 2,2 D 50,4 same as door	per lm TLE225	65
1	Melamine worktop W 90 H 2,2 D 50,4 same as door	per lm TLE225	65
2	Wall unit fixing strip lm 2	08610501	9
<b>TOTAL</b>			<b>3.357</b>

## COMPOSIZIONE BASSA L 255

LOW COMPOSITION W 255



## COMPOSIZIONE BASSA L 300

LOW COMPOSITION W 300



## COMPOSIZIONE BASSA L 255

LOW COMPOSITION W 255

(IVA e contributo RAEE esclusi)

(VAT and WEEE fee excluded)

### COMPONENTI

COMPONENTS

#### Colonna 60 H 217 frigo-freezer 230 classe A+

60 cm column H 217 fridge-freezer 230 class "A+"

#### Base 45 2 cassetti e cestone

45 cm base unit with 2 drawers and deep drawer

#### Base 60 forno statico inox

stainless steel static oven with orbital cooling ventilation 60 base unit

#### Piano cottura 60 4 gas inox con valvola di sicurezza

60 cm stainless steel hob with 4 gas burners with safety valve

#### Sottolavello 90

90 cm sink unit

#### Lavello ad incasso 86 x 50 1 vasca inox prelucidato

86x50 cm built-in sink with 1 stainless steel bowl

#### Pensile 45 H 72

45 cm wall unit H 72

#### Cappa 60 aspirante estraibile H 63 2 motori

60 cm hood slide-out ducting H 63 2 motors

#### Scolapiatti 90 H 72

90 cm plate rack H 72

#### Top 195 P 61 in laminato H 4

195 cm laminate worktop D 61 H 4

#### Asta appendipensili ml 2

2 lm wall unit fixing strip

**(Elettrodomestici Indesit )**

(Indesit appliances)

### VERSIONI

VERSIONS

**JEY FEEL**

**€ 3.837**

JEY FEEL

## COMPOSIZIONE BASSA L 300

LOW COMPOSITION W 300

(IVA e contributo RAEE esclusi)

(VAT and WEEE fee excluded)

### COMPONENTI

COMPONENTS

#### Colonna 60 H 217 frigo-freezer 230 classe A+

60 cm column H 217 fridge-freezer 230 class "A+"

#### Base 60 2 cassetti e cestone

60 cm base unit with 2 drawers and deep drawer

#### Base 60 forno statico inox

stainless steel static oven with orbital cooling ventilation 60 base unit

#### Piano cottura 60 4 gas inox con valvola di sicurezza

60 cm stainless steel hob with 4 gas burners with safety valve

#### Base 60

60 cm base unit

#### Sottolavello 60

60 cm sink unit

#### Lavello ad incasso 86 x 50 1 vasca inox prelucidato

86x50 cm built-in sink with 1 stainless steel bowl

#### Pensile 60 H 72

60 cm wall unit H 72

#### Cappa 60 aspirante estraibile H 63 2 motori

60 cm hood slide-out ducting H 63 2 motors

#### Pensile 60 H 72

60 cm wall unit H 72

#### Scolapiatti 60 H 72

60 cm plate rack H 72

#### Top 240 P 61 in laminato H 4

240 cm laminate worktop D 61 H 4

#### Asta appendipensili ml 4

4 lm wall unit fixing strip

**(Elettrodomestici Indesit )**

(Indesit appliances)

### VERSIONI

VERSIONS

**JEY FEEL**

**€ 4.096**

JEY FEEL

## COMPOSIZIONE ALTA L 300

HIGH COMPOSITION W 300



## COMPOSIZIONE BASSA L 360

LOW COMPOSITION W 360



## COMPOSIZIONE ALTA L 300

HIGH COMPOSITION W 300

(IVA e contributo RAEE esclusi)

(VAT and WEEE fee excluded)

### COMPONENTI

COMPONENTS

#### Colonna 60 H 241 frigo-freezer 230 classe A+

60 cm column H 241 fridge-freezer 230 class "A+"

#### Base 60 2 cassetti e cestone

60 cm base unit with 2 drawers and deep drawer

#### Base 60 forno statico inox

stainless steel static oven with orbital cooling ventilation 60 base unit

#### Piano cottura 60 4 gas inox con valvola di sicurezza

60 cm stainless steel hob with 4 gas burners with safety valve

#### Base 60

60 cm base unit

#### Sottolavello 60

60 cm sink unit

#### Lavello ad incasso 86 x 50 1 vasca inox prelucidato

86x50 cm built-in sink with 1 stainless steel bowl

#### Pensile 60 H 72

60 cm wall unit H 72

#### Cappa 60 aspirante estraibile H 63 2 motori

60 cm hood slide-out ducting H 63 2 motors

#### Pensile 60 H 96

60 cm wall unit H 96

#### Scolapiatti 60 H 96

60 cm plate rack H 96

#### Top 240 P 61 in laminato H 4

240 cm laminate worktop D 61 H 4

#### Mensola 120 P 31 sp. 3,8

120 cm shelf D 31 sp. 3,8

#### Asta appendipensili ml 4

4 lm wall unit fixing strip

(Elettrodomestici Indesit )

(Indesit appliances)

### VERSIONI

VERSIONS

JEY FEEL

€ 4.341

JEY FEEL

## COMPOSIZIONE BASSA L 360

LOW COMPOSITION W 360

(IVA e contributo RAEE esclusi)

(VAT and WEEE fee excluded)

### COMPONENTI

COMPONENTS

#### Colonna 60 H 217 frigo-freezer 230 classe A+

60 cm column H 217 fridge-freezer 230 class "A+"

#### Colonna 60 H 109 con cestone, forno statico inox con ventilazione tangenziale di raffreddamento

oven 60 column H 109 with deep drawer configured for static stainless steel with orbital cooling ventilation

#### Base 90 2 cassetti + cestone predisposto P.C.

90 cm base unit with 2 drawers + deep drawer configured for hob

#### Piano cottura 60 4 gas inox con valvola di sicurezza

60 cm stainless steel hob with 4 gas burners with safety valve

#### Base 60

60 cm base unit

#### Sottolavello 90

90 cm sink unit

#### Lavello ad incasso 86 x 50 1 vasca inox prelucidato

86x50 cm built-in sink with 1 stainless steel bowl

#### Pensile 60 H 72

60 cm wall unit H 72

#### Cappa 90 sempione acciaio inox satinato + vetro

90 cm sempione hood brushed stainless steel + glass

#### Pensile 60 H 72

60 cm wall unit H 72

#### Scolapiatti 90 H 72

90 cm plate rack H 72

#### Top 240 P 61 in laminato H 4

240 cm laminate worktop D 61 H 4

#### Top 60 P 61 in laminato H 4

60 cm laminate worktop D 61 H 4

#### Asta appendipensili ml 4

4 lm wall unit fixing strip

(Elettrodomestici Indesit )

(Indesit appliances)

### VERSIONI

VERSIONS

JEY FEEL

€ 4.468

JEY FEEL

