

MAGGIORAZIONE
SURCHARGE

+ 8%

DAL 23 GENNAIO 2023

FROM JANUARY 23, 2023

GRACE *classico*

listino 2022



CONDIZIONI GENERALI DI VENDITA

DECORRENZA

Il presente listino sostituisce ed annulla tutti i precedenti.

Non costituisce offerta e può essere modificato, con comunicazione scritta della LUBE INDUSTRIES s.r.l. al Cliente, in qualsiasi momento anche senza preavviso. Le modificazioni o gli aggiornamenti avranno efficacia rispetto a tutti gli ordinativi pervenuti o trasmessi alla LUBE INDUSTRIES s.r.l. dopo la comunicazione scritta di cui sopra.

PREZZI DI LISTINO E CONDIZIONI DI PAGAMENTO

I prezzi sono quotati al pubblico I.V.A. e contributo RAEE esclusi e si intendono franco fabbrica.

Decorso il termine contrattuale di pagamento la LUBE INDUSTRIES s.r.l. è autorizzata alla emissione di tratte a saldo di ogni suo avere maggiorate degli interessi, spese e di ogni altro onere accessorio, previa comunicazione al Cliente. In caso di pagamento oltre i termini contrattuali, saranno addebitati gli interessi ai sensi del D.lgs. 231/2002, oltre al recupero di eventuali sconti espressamente concessi in ragione del termine di pagamento.

In caso di mancato pagamento nei tempi contrattuali la LUBE INDUSTRIES s.r.l. potrà sospendere l'evasione degli ordini in corso previa comunicazione al Cliente.

CONSEGNA

I termini di consegna vengono computati in giorni lavorativi con decorrenza dal perfezionamento del contratto di vendita, che comunque si intende perfezionato entro 8 giorni dall'invio dell'ordine o comunque entro 8 giorni dall'ultimo chiarimento (se richiesto) fornito dal Cliente. I termini di consegna saranno prorogati automaticamente in dipendenza di avvenimenti non imputabili alla LUBE INDUSTRIES s.r.l. o a cause di forza maggiore. Sono sempre ammesse consegne parziali.

PRODOTTO

I dati tecnici relativi ai prodotti illustrati nel presente listino sono puramente indicativi. La LUBE INDUSTRIES s.r.l. si riserva la facoltà di apportare tutte le modifiche tecnico-costruttive migliorative del prodotto, senza obbligo di preavviso. Ciò vale anche per gli elettrodomestici o altri accessori impiegati a corredo delle cucine; questi potranno risultare esteticamente leggermente difformi in base alle marche utilizzate diverse da quelle da catalogo, salvo la sostanziale conformità delle caratteristiche e delle funzioni. Il Cliente potrà richiedere elementi specifici indicandone la marca sempre nell'ambito del ventaglio di offerte della LUBE INDUSTRIES s.r.l..

CONSISTENZA FINITURE

Le finiture potrebbero subire nel tempo modificazioni di colore dovute all'esposizione alla luce, al calore, ai vapori e all'invecchiamento. È, pertanto, naturale che in caso di successivi completamenti, si potranno avere delle differenze di tonalità che comunque dovrebbero tendere ad attenuarsi nel tempo. Per i piani in marmo e granito, considerando che il taglio proviene da BLOCCHI NATURALI, non possiamo garantire l'uniformità del colore e della grana. Questi fattori non potranno costituire motivo di contestazione o di resa del prodotto.

TRASPORTO

La merce non viaggia mai con mezzi della LUBE INDUSTRIES s.r.l. e, di conseguenza, nel momento in cui questa viene affidata al vettore, a prescindere da chi lo abbia incaricato, o caricata nel mezzo del cliente tutti i rischi passano al cliente stesso. Il Cliente, anche tramite suoi incaricati, ha l'obbligo di controllare l'integrità della merce all'arrivo ed, eventualmente, fare le dovute contestazioni scritte al Vettore. Qualora il danno rende inutilizzabile la merce è opportuno non ritirarla dandone conto nel Documento di Trasporto, diversamente con l'apposizione della firma da parte del Cliente, senza alcuna contestazione e/o rilievo si attesta la perfetta integrità e conformità della merce.

INSTALLAZIONE E IMPIEGO

La LUBE INDUSTRIES s.r.l. declina ogni responsabilità per l'errata o impropria installazione del prodotto fornito, siano essi di sua fabbricazione o di terzi, sempre che non provveda essa stessa alle predette operazioni.

La LUBE INDUSTRIES s.r.l. si ritiene esonerata da qualsiasi responsabilità circa il funzionamento degli elettrodomestici e degli accessori fabbricati da terzi costruttori, per i quali venga fornito dal predetto fabbricante lo specifico libretto di uso e manutenzione; nel libretto si troverà indicato l'eventuale Ufficio Reclami o i Centri di Assistenza del terzo fabbricante.

Per l'impropria e/o inadeguata manutenzione, nonché per l'improprio e/o inadeguato utilizzo dei prodotti venduti, la LUBE INDUSTRIES s.r.l. rinvia ogni e qualsiasi responsabilità e/o onere al Cliente o all'Utilizzatore.

RECLAMI ED AZIONI

I vizi e i difetti devono essere denunciati alla LUBE INDUSTRIES s.r.l. nei termini di legge. Anche nel caso di contestazione i pagamenti non potranno essere sospesi.

La merce rimarrà di proprietà della LUBE INDUSTRIES s.r.l. sino al pagamento totale da parte del committente.

GARANZIA

La garanzia sui prodotti venduti opererà per il tempo che, di volta in volta, le leggi vigenti nel Paese del Cliente stabiliranno come minimo a favore dell'acquirente.

RESTITUZIONE DI MERCE

La restituzione delle merci vendute si accetta solo se espressamente autorizzata dalla LUBE INDUSTRIES s.r.l.. Verranno concordate modalità di reintegro e di accredito, solo qualora la restituzione sia dovuta a fatti imputabili alla LUBE INDUSTRIES s.r.l.. La merce restituita dovrà essere consegnata in perfette condizioni e adeguatamente imballata. La merce da sostituire dovrà essere restituita senza ritardo dal commerciante alla fabbricante. Nel caso in cui detta merce sia restituita fino a sei mesi dalla sostituzione la fabbricante accrediterà al commerciante il cento per cento del valore della stessa; tra i sei e i nove mesi sarà accreditato al commerciante il settanta per cento del valore della merce; qualora la restituzione avvenga tra i nove ed i dodici mesi dalla sostituzione sarà accreditato al commerciante il cinquanta per cento del valore della merce; qualora la restituzione non sia compiuta nei dodici mesi non vi sarà accreditato nessun valore della merce sostituita.

SPESE

Per i pagamenti a mezzo tratte o ricevute bancarie verranno addebitati tutti gli oneri accessori alla riscossione.

CONTROVERSIE

Per ogni controversia il Foro competente sarà esclusivamente quello di Macerata.

EFFICACIA

Il Cliente, con il solo fatto di conferire l'ordinativo, si dichiara edotto ed accetta tutte le condizioni di vendita che precedono, salvo espresso patto contrario.

GENERAL SALES CONDITIONS

VALIDITY

This price list replaces and annuls all previous versions.

It does not constitute an offer and may be subject to change following a written notification by LUBE INDUSTRIES s.r.l. to the Customer, at any time and without prior notice.

Any modifications or updates shall apply to all orders received by or transmitted to LUBE INDUSTRIES s.r.l. following the above-mentioned written notification.

RETAIL PRICES AND PAYMENT TERMS

The retail prices quoted are exclusive of VAT and the WEEE fee and are ex works.

Upon expiry of the agreed payment term, LUBE INDUSTRIES s.r.l. shall be authorised to issue bills of exchange for any outstanding amounts on every item, plus interest, expenses and any other additional liability, prior notification to the Customer. In the event of payment after the agreed term, accrued interest shall be charged in compliance with Italian Legislative Decree no. 231/2002, while any discounts expressly granted in relation to the payment terms shall be recovered.

If payment is not received within the agreed terms, LUBE INDUSTRIES s.r.l. shall be entitled to suspend fulfilment of current orders, prior notification to the Customer.

DELIVERY

The delivery term is calculated in working days and takes effect from the date on which the sales contract is stipulated. In any case, the contract is considered effective within 8 days from order transmission or, at all events, within 8 days from the most recent clarification (if requested) provided by the Customer. The delivery term shall be automatically extended should any events occur that are not imputable to LUBE INDUSTRIES s.r.l. or that are due to force majeure. Partial deliveries can always be effected.

THE PRODUCT

Any technical data relative to the products illustrated in this price list is purely indicative. LUBE INDUSTRIES s.r.l. reserves the right to effect any necessary technical-construction changes to improve the product, without prior notification. This right extends to household appliances or other kitchen furniture accessories; the appearance of the latter may slightly differ depending on the brand used (which may be different to that shown in the catalogue), without prejudice to the basic conformity of features and functions. The Customer may request specific elements by indicating the relative brand, provided these are included in the range of solutions offered by LUBE INDUSTRIES s.r.l..

CONSISTENCY OF THE FINISHES

The finishes may be subject to slight changes in colour over time as a result of exposure to light, heat, vapours and ageing. Therefore, in the event of completion orders, there may be shade differences that will tend to diminish over time. Regarding marble and granite worktops, we cannot guarantee uniformity of colour and vein pattern as the worktops are cut from NATURAL BLOCKS. These factors may not provide grounds for claims or return of products.

TRANSPORT

The goods never travel on vehicles owned by LUBE INDUSTRIES s.r.l.; therefore, from the moment the goods are handed over to the forwarder and regardless of who entrusted the latter with the transport or loaded the goods into the customer's vehicle, all risks are transferred to the customer. The Customer - also through persons delegated by the latter - is obliged to check the integrity of the goods upon their arrival, and to notify written claims to the Forwarder. The Customer should not accept any damaged goods that are unsuitable for their intended use, and should notify the relevant claim on the transport document; otherwise, by signing the transport document without adding any claims and/or observations, the Customer certifies the integrity and conformity of the goods.

INSTALLATION AND USE

LUBE INDUSTRIES s.r.l. shall not be held liable for incorrect or improper installation of the supplied product, whether manufactured by the company or by third parties, unless LUBE INDUSTRIES s.r.l. carries out the installation directly.

Moreover, LUBE INDUSTRIES s.r.l. shall not be held liable for the operation of household appliances and accessories manufactured by third parties that provide the relevant use and maintenance manual; the manual includes information on the Claims Office or Technical Assistance Centres of the third party manufacturer. Regarding improper and/or inadequate maintenance, or any improper and/or inadequate use of the products sold, LUBE INDUSTRIES s.r.l. transfers each and every liability and/or cost to the Customer or User.

CLAIMS

Any faults or defects must be reported to LUBE INDUSTRIES s.r.l. within the terms specified by the law. Payment may not be suspended, even in the event of notification of claims. The goods shall remain the property of LUBE INDUSTRIES s.r.l. unless fully paid by customer.

WARRANTY

Warranty on sold products in favour of the purchaser shall apply for the minimum duration specified case-by-case by the laws in force in the Customer's country.

RETURN OF GOODS

Return of sold goods is only accepted if expressly authorised by LUBE INDUSTRIES s.r.l.. Replacement or reimbursement of said goods shall be mutually denied only if the goods return is due to events imputable to LUBE INDUSTRIES s.r.l.. The returned goods must be delivered in perfect conditions and suitably packaged.

The goods to be replaced must be returned from the retailer to the producer without delay. In the case that the goods are returned until six months after replacing the producer will credit the retailer 100% of the replaced goods value; between six and nine months after replacing, the producer will credit the retailer 70% of the replaced goods value; if the return is between nine and twelve months after the replacement, will be credited to the retailer 50% of the replaced goods value; if the refund is not made within twelve months will not be credited any of the replaced goods value.

EXPENSES

For payments effected through bill of exchange or cash order, all additional collection expenses shall be charged.

DISPUTES

The Court of Macerata shall have sole jurisdiction for any disputes that may arise.

EFFECTIVENESS

For the sole fact of conferring the order, the Customer declares to be informed and accepts all the aforementioned sale conditions, unless otherwise expressly agreed on.

INFORMAZIONI TECNICHE

TECHNICAL INFORMATION

Le misure indicate nel presente listino sono espresse in cm.

Le profondità delle basi si intendono comprensive di top.

Le profondità dei pensili e delle colonne si intendono comprensive di ante.

Le altezze delle basi e delle colonne si intendono comprensive di zoccolo

Il verso degli elementi è individuato dalla posizione delle cerniere. Fanno eccezione solo l'angolo base e la colonna ad angolo dove il verso viene individuato dalla posizione dell'anta rispetto al mobile.

Per gli elementi con il verso, è stato inserito il codice con entrambi i versi (ad esempio una base da cm 45 cod. E4010451/2).

Sarà quindi necessario specificare se l'ultima cifra dovrà essere "1" per il verso destro cioè E4010451 oppure "2" per il verso sinistro cioè E4010452.

Per i lavelli il verso dx o sx è individuato dalla posizione delle vasche.

I prezzi indicati sono espressi all'unità di euro e sono IVA e contributo RAEE esclusi

I prezzi delle basi e delle colonne sono comprensivi dello zoccolo standard.

Per tutti i mobili fuori misura ha valore il listino riportato nella pagina maggiorazioni fuori misura.

Nel caso vengano richieste maniglie con passo diverso da quello previsto dal modello, le ante verranno fornite senza fori maniglia.

I colori delle immagini riportate nel presente listino sono solamente indicativi e non possono essere utilizzati come riferimento.

The measurements appearing in this price list are expressed in cm.

The depths of base units are inclusive of the worktop.

The depths of the wall units and columns are inclusive of the doors.

The heights of the base units and columns are inclusive of the plinth.

The direction of the elements is determined by the position of the hinges. The only exceptions are the corner base unit and corner column, where the direction is determined by the position of the door in relation to the cabinet.

For elements that come with a direction, the code includes both directions (e.g. 45 cm base unit - code E4010451/2).

It is therefore necessary to specify the last figure - "1" for the RH direction, i.e. E4010451, or "2" for the LH direction, i.e. E4010452.

The RH or LH direction of the sinks is determined by the position of the bowls.

The prices indicated are expressed in units of Euro and exclude VAT and the WEEE fee.

Prices of the base units and columns are inclusive of the standard plinth.

The prices that apply to all custom-sized cabinets are indicated on the page "Surcharges for custom-sized elements".

In the event of handles requested with a different centre-to-centre distance compared to the standard for the model, the doors will be supplied without pre-drilled holes for the handles.

The colours in the pictures appearing in this price list are purely indicative and should not be used as reference.

COMPOSIZIONI SENZA ELETTRODOMESTICI E SENZA TOP

COMPOSITIONS WITHOUT HOUSEHOLD APPLIANCES AND WORKTOP

Tutte le composizioni richieste prive di elettrodomestici (frigo, forno, piano cottura, lavastoviglie o lavatrice), saranno aumentate di un importo netto pari a € 150 iva esclusa. Tale direttiva non si applica se la cucina contiene almeno due di questi elettrodomestici.

Tutte le composizioni richieste prive di top, saranno aumentate di un importo netto pari a € 100 iva esclusa.

All compositions requested without household appliances (fridge, oven, cooker hob, dishwasher or washing machine) shall be subject to a price increase of € 150 VAT excluded. This measure does not apply if the kitchen contains at least two of the above-mentioned appliances.

All compositions requested without worktop shall be subject to a price increase of € 100 VAT excluded.

MAGGIORAZIONI PER ELEMENTI FUORI MISURA

SURCHARGES FOR CUSTOM-SIZED ELEMENTS

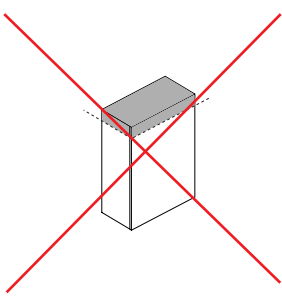
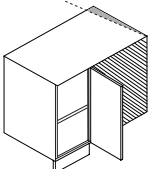
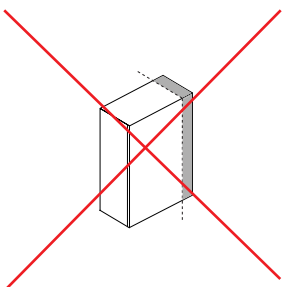
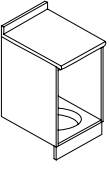
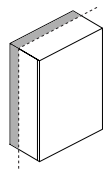
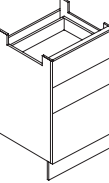
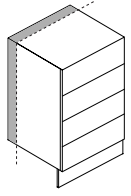
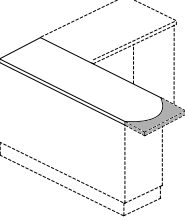
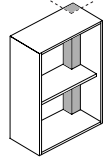
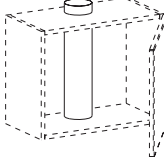
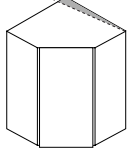
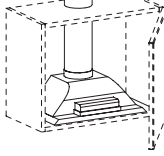
	DESCRIZIONE DESCRIPTION	MAGGIORAZIONE SURCHARGE		DESCRIZIONE DESCRIPTION	MAGGIORAZIONE SURCHARGE
	<p>Riduzioni in altezza non realizzabili</p> <p>The height cannot be reduction</p>			<p>Basi angolo fuori squadra</p> <p>Out-of-plumb corner base units</p>	
	<p>Basi Base units</p> <p>Pensili Wall units</p> <p>Colonne Columns</p>	<p>NO</p> <p>NO</p> <p>NO</p>			+ 28 %
	<p>Riduzioni in larghezza non realizzabili</p> <p>The width cannot be reduced</p>			<p>Basi e sottolavelli con portabombola</p> <p>Base and sink base units with cylinder holder</p>	
	<p>Basi Base units</p> <p>Pensili Wall units</p> <p>Colonne Columns</p>	<p>NO</p> <p>NO</p> <p>NO</p>			+ 20 €
	<p>Riduzioni in profondità</p> <p>Depth reduction</p>			<p>Maggiorazioni per fianco scavato per inserimento piano cottura tra due basi (PPC opz. 011/012)</p> <p>Surcharge for digged side to insert cooking hob between two bases (PPC opt. 011/012)</p>	
	<p>Basi Base units</p> <p>Pensili Wall units</p> <p>Colonne Columns</p>	<p>+ 18 %</p> <p>+ 18 %</p> <p>+ 18 %</p>		<p>Cadauno each</p>	+ 23 €
	<p>Riduzioni per cassettera</p> <p>N.B.: modificabili solo in profondità fino a 31 cm al fianco</p> <p>Reductions for drawer unit</p> <p>Note: can only be modified depth-wise up to 31 cm on the side</p>			<p>Maggiorazioni per raggatura top e mensola in laminato</p> <p>Surcharges for rounded edge on laminate worktop and shelf</p>	
		+ 18 %		<p>Codice code T9STP</p>	+ 38 €
	<p>Taglio per pilastro</p> <p>N.B.: non realizzabile nei pensili con meccanismi</p> <p>Indent for pilaster</p> <p>Note: not feasible on wall units with mechanisms</p>			<p>Maggiorazione per inserimento tubo cappa (da sommare al prezzo del pensile)</p> <p>Surcharge for insertion of the hood pipe (to be added to the price of the wall unit)</p>	
	<p>Basi Base units</p> <p>Pensili Wall units</p> <p>Colonne Columns</p>	<p>+ 90 €</p> <p>+ 90 €</p> <p>+ 130 €</p>			+ 90 €
	<p>Pensili angolo fuori squadra</p> <p>Out-of-plumb corner wall units</p>			<p>Maggiorazione per inserimento cappa non standard</p> <p>N.B.: verificare sempre la fattibilità dell'incasso con il nostro ufficio tecnico</p> <p>Surcharge for the insertion of a non-standard hood</p> <p>Note: always verify the feasibility of the installation</p>	
		+ 28 %			+ 90 €

La maggiorazione è da applicare al prezzo dell'elemento di serie più grande rispetto a quello delle dimensioni richieste.

Negli elementi fuori misura per motivi di lavorazione, l'estetica può risultare inferiore agli elementi di serie.

The surcharge applies to the price of the standard element that is next largest to that of the requested size.

Due to the processing involved, the aesthetic level of custom-sized elements may be slightly inferior to that of standard elements.

grace

CARATTERISTICHE
TECNICHE
TECHNICAL FEATURES

Grace indossa un abito classico di intramontabile eleganza, fatto di colori delicati opachi, ante a telaio piene o con vetro rilegato o decorato, per abitare spazi sia piccoli che grandi con gusto e flessibilità.

Lo stile classico le dona un aspetto romantico e intramontabile, dotata di accessori funzionali e dettagli unici, Grace si distingue per equilibrare estetica e praticità con soluzioni adatte alle esigenze del vivere moderno, con elementi tecnologici.

Flessibile e componibile, Grace celebra i piccoli gesti della vita quotidiana.



Grace expresses a classic style of timeless elegance, made of soft matt colors, solid framed doors or with bound or decorated glass, to fit both small and large spaces, with taste and flexibility. The classic style gives it a romantic and timeless look, equipped with functional accessories and unique details. Grace stands out for balancing aesthetics and practicality with solutions suited to the needs of modern living, with technological elements.

Flexible and modular, Grace celebrates the small gestures of everyday life.

cod. **K80**

grace

SP. 20 MM

N.B.: i prezzi sono espressi all'unità di euro (iva esclusa)

CARATTERISTICHE TECNICHE

ANTE E FRONTALI CASSETTI

anta in 5 pezzi (conforme **US EPA TSCA Title VI**) in massello di frassino con cartella mdf impiallacciata e laccata a poro aperto nei colori: bianco camelia (opz.2475), grigio reale (opz.2477), argilla decapè (opz.2476), verde cinabro (opz.2479)

anta in 5 pezzi (conforme **US EPA TSCA Title VI**) in massello di frassino con cartella mdf impiallacciata e tinta a poro aperto nel colore: tinto noce (opz.2478)

ANTE VETRO di serie

anta in 5 pezzi (conforme **US EPA TSCA Title VI**) in massello di frassino laccata a poro aperto con inglesina rilegata nickel ottone, vetro extrachiaro trasparente e satinato nei colori: bianco camelia (opz.2475I), grigio reale (opz.2477I), argilla decapè (opz.2476I), verde cinabro (opz.2479I)

anta in 5 pezzi (conforme **US EPA TSCA Title VI**) in massello di frassino tinto a poro aperto con inglesina rilegata nickel ottone, vetro extrachiaro trasparente e satinato nel colore: tinto noce (opz.2478I)

a richiesta

anta in 5 pezzi (conforme **US EPA TSCA Title VI**) in massello di frassino olivato laccata a poro aperto con vetro molato antico "F" nei colori: bianco camelia (opz.2475T), grigio reale (opz.2477T), argilla decapè (opz.2476T), verde cinabro (opz.2479T)

anta in 5 pezzi (conforme **US EPA TSCA Title VI**) in massello di frassino bianco tinto a poro aperto con vetro molato antico "F" nel colore: tinto noce (opz.2478T)

MANIGLIE

vedi pag.14

STRUTTURE DI SERIE

ANTA: FRASSINO BIANCO CAMELIA
nobilitato lino effetto tela (opz.8920) schiena e ripiano conchiglia (opz.8910)

ANTE: FRASSINO ARGILLA DECAPÈ, FRASSINO VERDE CINABRO, FRASSINO TINTO NOCE
nobilitato juta effetto tela (opz.9490) schiena e ripiano visone (opz.948M)

ANTA: FRASSINO GRIGIO REALE
nobilitato grigio effetto tela (opz.9695) schiena e ripiano argilla (opz.9690)



*per componenti si intendono tutte le strutture, alcune ante e alcuni complementi del modello.



GREENGUARD
LE STRUTTURE DELLE CUCINE SONO CONTRADDISTINTE DALLA CERTIFICAZIONE GREENGUARD, PER SODDISFARE GLI STANDARD PIU' RIGOROSI IN TERMINI DI LIVELLI DI EMISSIONE DI COMPOSTI ORGANICI VOLATILI (COV).

MENSOLE

di serie: altezza 3,8 cm in laminato conchiglia (opz.8910), visone (opz.948M), argilla (opz.9690)

a richiesta: altezza 3,8 cm finiture come ante

ZOCCOLI

vedi pag.17



TH. 20 MM

Note: the prices are expressed in units of euro (vat excluded)

TECHNICAL SPECIFICATIONS

DOORS AND DRAWER FRONT PANELS	<p>door composed of 5 pieces (compliant with US EPA TSCA Title VI) in solid ash with veneered mdf folder and open pore lacquered in the following colors: camelia white (opz.2475), royal grey (opz.2477), clay pickled (opz.2476), cinabro green (opz.2479)</p> <p>door composed of 5 pieces (compliant with US EPA TSCA Title VI), in solid ash with veneered mdf folder and stained open pore in the color: walnut stained (opz.2478)</p>
GLASS DOORS standard	<p>door composed of 5 pieces (compliant with US EPA TSCA Title VI), in open-pore lacquered solid ash with nickel brass bound glass panel, transparent extra-clear and satin glass in the colors: camelia white (opz.2475I), royal grey (opz.2477I), clay pickled (opz.2476I), cinabro green (opz.2479I)</p> <p>door composed of 5 pieces (compliant with US EPA TSCA Title VI), in open-pore stained solid ash with nickel brass bound glass panel, transparent extra-clear and satin glass in the colors: walnut stained (opz.2478I)</p>
on request	<p>door composed of 5 pieces (compliant with US EPA TSCA Title VI), in solid olive ash, open pore lacquered with "F" ground glass in the colors: camelia white (opz.2475T), royal grey (opz.2477T), clay pickled (opz.2476T), cinabro green (opz.2479T)</p> <p>door composed of 5 pieces (compliant with US EPA TSCA Title VI), in open pore stained solid white ash with "F" ground glass in the color: walnut stained (opz.2478T)</p>
HANDLES	<p>see page 14</p>
STANDARD STRUCTURES	<p>DOOR: CAMELIA WHITE ASH linen melamine-coated canvas effect (opt.8920), shell back panel and shelf (opz.8910)</p> <p>DOORS: CLAY PICKLED ASH, CINABRO GREEN ASH, WALNUT STAINED ASH jute melamine-coated canvas effect (opt.9490), mink back panel and shelf (opz.948M)</p> <p>DOOR: ROYAL GREY ASH grey melamine-coated canvas effect (opt.9695), clay back panel and shelf (opz.9690)</p>
SHELVES	<p>standard: 3.8 cm thick, laminate, seashell (opz.8910), mink (opz.948M), clay (opt.9690)</p> <p>on request: 3.8 cm thick, with the same finish as doors</p>
PLINTHS	<p>see page 17</p>

cod. **K80** SP. 20 MM
TH. 20 MM

grace

ante in frassino laccato a poro aperto
lacquered ash doors open pore

PREZZI FASCIA "A"
PRICES BAND "A"

 *colori in pronta consegna
available colours*



frassino bianco camelia
(opz.2475)
camelia white ash



frassino grigio reale
(opz.2477)
royal grey ash

anta laccata decapata a poro aperto
lacquered pickled door open pore



frassino argilla decapè
(opz.2476)
clay pickled ash

SP. 20 MM
TH. 20 MM

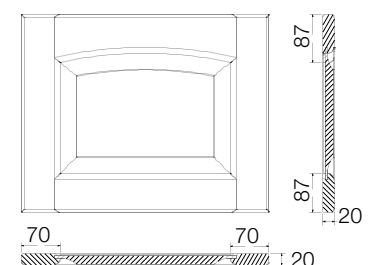

cod. **K80** SP. 20 MM
TH. 20 MM

grace

anta in frassino tinto a poro aperto
stained ash door open pore

PREZZI FASCIA "B"
PRICES BAND "B"



frassino tinto noce
(opz.2478)
walnut stained ash

anta in frassino laccato a poro aperto
lacquered ash door open pore



frassino verde cinabro
(opz.2479)
cinabro green ash

SP. 20 MM
TH. 20 MM

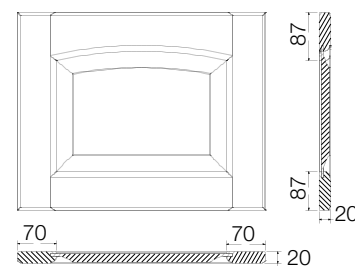

cod. **K80** SP. 20 MM
TH. 20 MM

grace

ante vetro rilegato con inglesina telaio di frassino laccato a poro aperto
glass panelled bound door, open pore lacquered ash frame

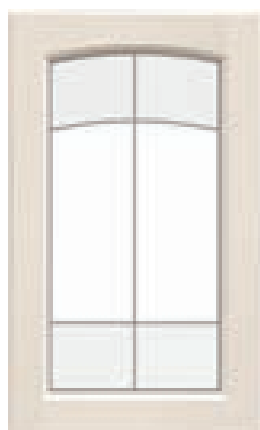

frassino bianco camelia
(opz.2475l) rilegatura nickel
con vetro extrachiaro
trasparente e satinato
camellia white ash
(opt. 2475l) nickel binding
with transparent, extra-clear
and satin glass

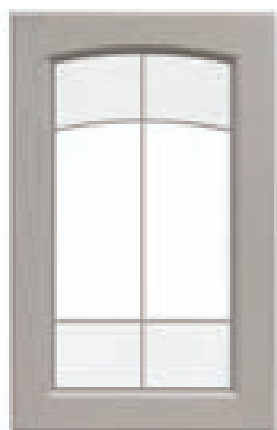

frassino grigio reale
(opz.2477l) rilegatura nickel
con vetro extrachiaro
trasparente e satinato
royal grey ash
(opt. 2477l) nickel binding
with transparent, extra-clear
and satin glass

 *colori in pronta consegna
available colours*

**PREZZI FASCIA "A"
PRICES BAND "A"**

anta vetro rilegato con inglesina telaio di frassino laccato decapato a poro aperto
glass panelled bound door, lacquered pickled ash frame



frassino argilla decapè
(opz.2476l) rilegatura nickel
con vetro extrachiaro
trasparente e satinato
clay pickled ash
(opt. 2476l) nickel binding
with transparent, extra-clear
and satin glass

**SP. 20 MM
TH. 20 MM**

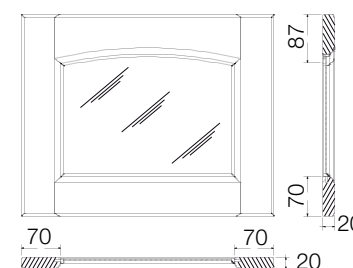

cod. **K80** SP. 20 MM
TH. 20 MM

grace

anta vetro rilegato con inglesina telaio di frassino tinto a poro aperto
glass panelled bound door, open pore stained ash frame



frassino tinto noce
(opz.2478I) rilegatura nickel
con vetro extrachiario
trasparente e satinato
walnut stained ash
(opt. 2478I) nickel binding with
transparent, extra-clear and
satin glass

PREZZI FASCIA "B"
PRICES BAND "B"

anta vetro rilegato con inglesina telaio frassino laccato a poro aperto
glass panelled bound door, open pore lacquered ash frame



frassino verde cinabro
(opz.2479I) rilegatura nickel
con vetro extrachiario
trasparente e satinato
cinabro green ash
(opt. 2479I) nickel binding with
transparent, extra-clear and
satin glass

SP. 20 MM
TH. 20 MM

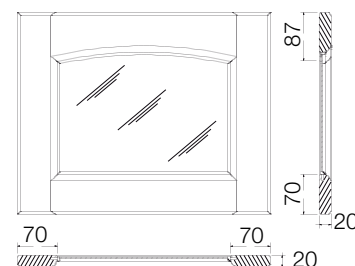

cod. **K80** SP. 20 MM
TH. 20 MM

grace

ante vetro molato telaio di frassino laccato a poro aperto
ground glass doors open pore lacquered ash frame



frassino bianco camelia
(opt.2475T) con vetro
molato antico "F"
camellia white ash
(opt.2475T) with "F"
antique ground glass



frassino grigio reale
(opt.2477T) con vetro
molato antico "F"
royal grey ash
(opt.2477T) with "F"
antique ground glass

 *colori in pronta consegna
available colours*

PREZZI FASCIA "A"
PRICES BAND "A"

anta vetro molato telaio di frassino laccato decapato a poro aperto
ground glass door open pore pickled lacquered ash frame



frassino argilla decapè
(opt.2476T) con vetro
molato antico "F"
clay pickled ash
(opt.2476T) with "F"
antique ground glass

SP. 20 MM
TH. 20 MM

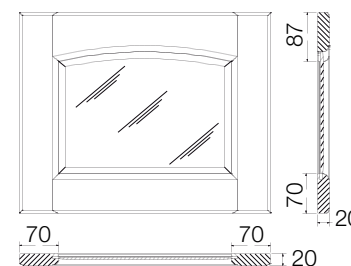

cod. **K80** SP. 20 MM
TH. 20 MM

grace

anta vetro molato telaio di frassino tinto a poro aperto
ground glass door with open pore stained ash frame



frassino tinto noce
(opz.2478T) con vetro
molato antico "F"
walnut stained ash
(opt.2478T) with "F"
antique ground glass

PREZZI FASCIA "B"
PRICES BAND "B"

anta vetro molato telaio frassino laccato a poro aperto
ground glass door with open pore lacquered ash frame

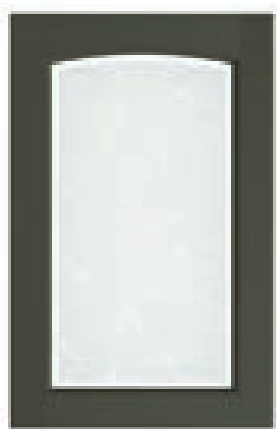

frassino verde cinabro
(opz.2479T) con vetro
molato antico "F"
cinabro green ash
(opt.2479T) with "F"
antique ground glass

SP. 20 MM
TH. 20 MM

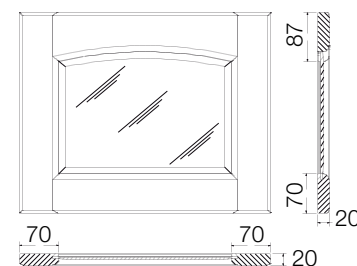

MANIGLIE HANDLES

DI SERIE STANDARD



Maniglia 175 finitura silver dark
anta L 15 → passo 96 mm
anta da L 30 a 90 → passo 160 mm

Handle 175 dark silver finish
door W 15 → centre-to-centre distance 96 mm
door from W 30 to W 90 → centre-to-centre distance 160 mm

A RICHIESTA ON REQUEST



Maniglia 176 finitura ottone
anta L 15 → pomo
anta da L 30 a 90 → passo 128 mm

Handle 176 brass finish
door W 15 → knob
door from W 30 to W 90 → centre-to-centre distance 128 mm

A RICHIESTA ON REQUEST



Maniglia 172A finitura argento vecchio brillante
anta L 15 → passo 96 mm
anta da L 30 a 90 → passo 160 mm

Handle 172A polished old silver finish
door W 15 → centre-to-centre distance 96 mm
door from W 30 to W 90 → centre-to-centre distance 160 mm

A RICHIESTA ON REQUEST



Maniglia 228 finitura ottone vecchio
inserto avorio
passo 128 mm
Handle 228 with old brass finish
with ivory insert
128 mm centre-to-centre distance



Pomo 228P finitura ottone vecchio
utilizzata per elementi da 15
con maniglia 228
Knob hole 228P with old brass finish
used for 15 cm elements with handle 228

A RICHIESTA ON REQUEST



Maniglia 230 finitura argento antico
passo 128 mm
Handle 230 with antique silver finish
128 mm centre-to-centre distance



Pomo 200P finitura argento antico
passo 16 mm
Knob hole 200P antique silver finish
centre-to-centre distance 16 mm

A RICHIESTA ON REQUEST



Maniglia 255P finitura piombo spazzolato
passo 160 mm
Handle 255P brushed lead finish
160 mm centre-to-centre distance



Pomo 255PP finitura piombo spazzolato
utilizzato per elementi da 15
con maniglia 255P
Knob hole 255PP antique silver finish
used for 15 cm elements with handle 255P

A RICHIESTA ON REQUEST



Maniglia 255N finitura nichel satinato
passo 160 mm
Handle 255N nickel satin finish
160 mm centre-to-centre distance



Pomo 255NP finitura nichel satinato
utilizzato per elementi da 15
con maniglia 255N
Knob hole 255NP antique silver finish
used for 15 cm elements with handle 255N

A RICHIESTA ON REQUEST



Maniglia 255R finitura rame antico
passo 160 mm
Handle 255R antique copper finish
160 mm centre-to-centre distance



Pomo 255RP finitura rame antico
utilizzato per elementi da 15
con maniglia 255R
Knob hole 255RP antique copper finish
used for 15 cm elements with handle 255R

A RICHIESTA ON REQUEST



Maniglia 255T finitura ottone antico
passo 160 mm
Handle 255T antique brass finish
160 mm centre-to-centre distance



Pomo 255TP finitura ottone antico
utilizzato per elementi da 15
con maniglia 255T
Knob hole 255TP antique brass finish
used for 15 cm elements with handle 255T



strutture carcasses



lino effetto tela (opz.8920)
schiena e ripiano conchiglia
(opz.8910)
linen melamine-coated canvas
effect (opt.8920)
seashell back panel and shelf
(opt.8910)



juta effetto tela (opz.9490)
schiena e ripiano visone
(opz.948M)
jute melamine-coated canvas
effect (opt.9490)
mink back panel and shelf
(opt.948M)



grigio effetto tela (opz.9695)
schiena e ripiano argilla
(opz.9690)
grey melamine-coated canvas
effect (opt.9695)
clay back panel and shelf
(opt.9690)



*per componenti si intendono tutte le strutture, alcune ante e alcuni complementi del modello.



GREENGUARD
LE STRUTTURE DELLE CUCINE SONO CONTRADDISTINTE DALLA CERTIFICAZIONE GREENGUARD, PER SODDISFARE GLI STANDARD PIU' RIGOROSI IN TERMINI DI LIVELLI DI EMISSIONE DI COMPOSTI ORGANICI VOLATILI (COV).

mensole in laminato laminate shelves



conchiglia (opz.8910)
seashell (opt.8910)



visone (opz.948M)
mink (opt.948M)



argilla (opz.9690)
clay (opt.9690)

mensole impialacciate veneered shelves



impialacciata come anta
N.B.: per le finiture vedi colore ante pag.8-9
veneered same finish as door
Note: for the finishes see door colours see page 8-9

zoccoli in pvc H 13 pvc plinths H 13



argilla decapè (opz.587)
clay pickled (opt.587)



bianco camelia (opz.606)
camelia white (opt.606)



tinto noce (opz.589)
walnut stained (opt.589)

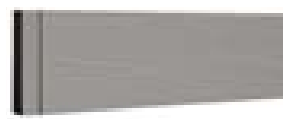

grigio reale (opz.595)
royal grey (opt.595)

zoccolo in alluminio H 13 aluminium plinth H 13

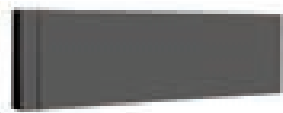

alluminio finitura silver dark
(opz.9507)
aluminium dark silver finish
(opt.9507)



alluminio finitura titanio ossidato
(opz.414)
aluminium titanium oxidized finish
(opt.414)



alluminio finitura ottone
(opz.7761)
aluminium brass finish
(opt.7761)

magg. rispetto allo zoccolo standard
surcharges compared to standard plinth

al ml per lm cod.092125 code +20 €

angolare angular cod.0923933 code +2 €

cornici cappello top cornices



argilla decapè (opz.2476)
clay pickled (opt.2476)

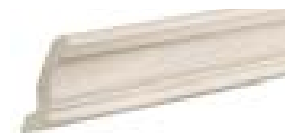

bianco camelia (opz.2475)
camelia white (opt.2475)

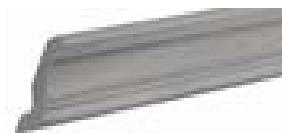

grigio reale (opz.2477)
royal grey (opt.2477)



tinto noce (opz.2478)
walnut stained (opt.2478)



verde cinabro (opz.2479)
cinabro green (opt.2479)

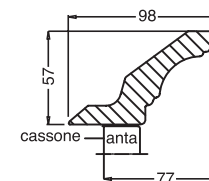

disegno cornice
design cornice

MODULARITÀ E COMPONIBILITÀ MODULARITY AND FITTING SOLUTIONS

BASI H 73
BASE UNITS H 73

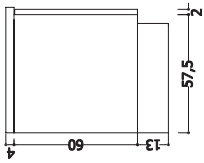

BASI SOSPESE
HANGING BASE UNITS

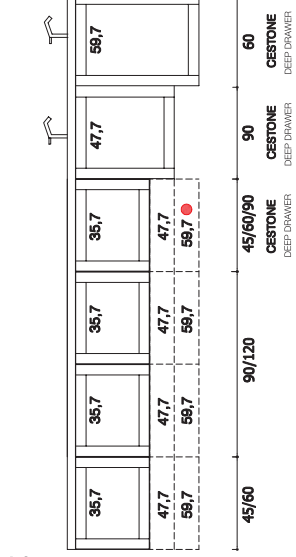
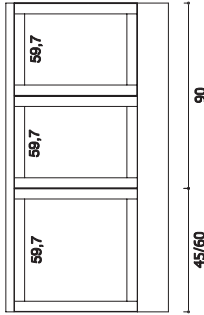

BASI LIVING
LIVING BASE UNITS

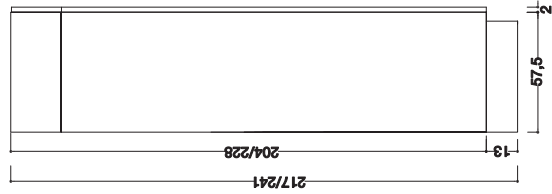
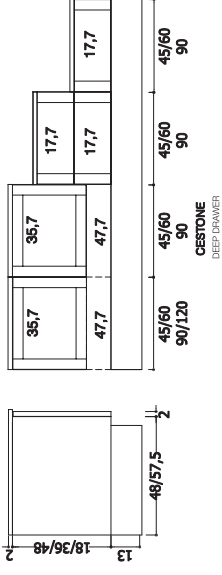

COLONNE FRIGO
FRIDGE COLUMNS

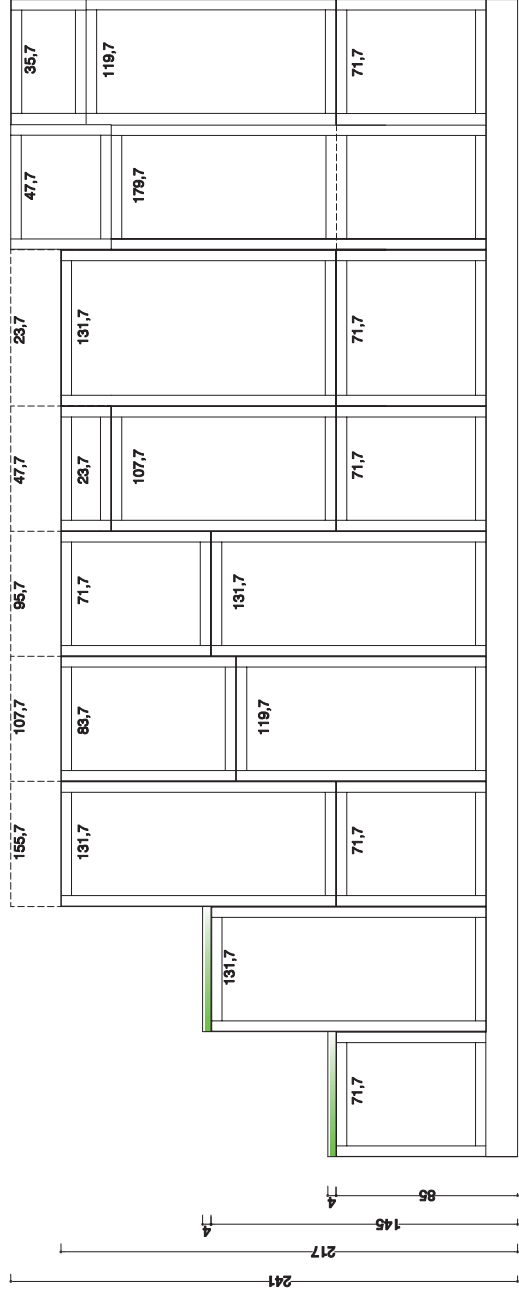

● **ESCLUSO 90**
EXCLUDING 90

60
FRIGO CONG. SOTTOTOP
UNDER TOP
FRIDGE FREEZER

60
FRIGO LT 215 MONOPORTA
SINGLE DOOR
FRIDGE 215 LT

60
FRIGO CONG. 1 MOTORE LT 315 - LT 330
FRIDGE FREEZER
1 MOTOR
315 LT/330 LT
330 LT

60
FRIGO LT 280 - LT 230
FRIDGE 280 LT
230 LT

60
FRIGO LT 215
FRIDGE 215 LT

60
FRIGO CONG. LT 315 3 ANTE
FRIDGE FREEZER
315 LT
3 DOORS





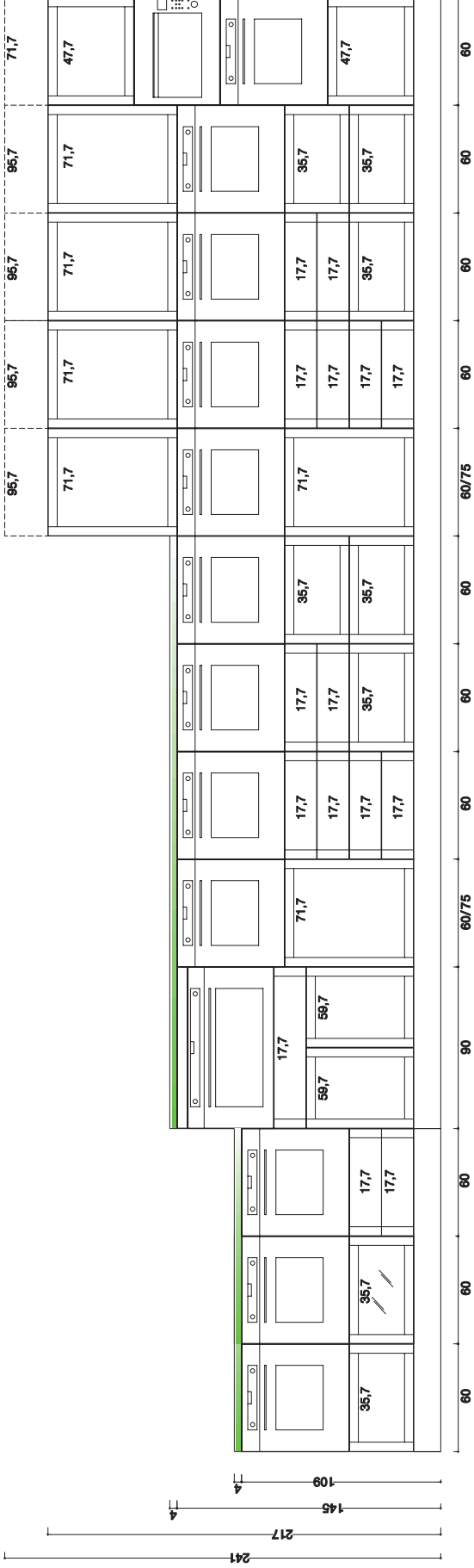
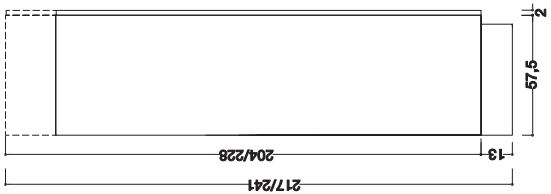

75
FRIGO CONG. LT 400
FRIDGE FREEZER
400 LT

60
FRIGO CONG. LT 300 MONOPORTA
SINGLE DOOR
FRIDGE FREEZER
300 LT

60
FRIGO CONG. LT 330 3 ANTE
FRIDGE FREEZER
330 LT
3 DOORS

COLONNE FORNO
OVEN COLUMNS







		COD.	FASCIA A K80	FASCIA B K80				
 <p>1 anta H 36 1 door H 36</p>								
	L 45	E2030451/2	142	176				
	L 60	E2030601/2	157	196				
	L 65	E2030651/2	162	202				
 <p>1 anta H 48 1 door H 48</p>								
	L 45	E2040451/2	163	202				
	L 60	E2040601/2	182	227				
	L 65	E2040651/2	190	237				
 <p>1 anta H 60 1 door H 60</p>								
	L 45	E2060451/2	171	215				
	L 60	E2060601/2	193	244				
 <p>1 anta H 72 1 door H 72</p>								
	L 15	E2010151/2	141	171				
	L 30	E2010301/2	160	199				
	L 40	E2010401/2	176	221				
	L 45	E2010451/2	181	227				
	L 60	E2010601/2	209	266				
	L 65	E2010651/2	217	278				
	L 75	E2010751/2	254	321				
 <p>1 anta H 96 1 door H 96</p>								
	L 15	E2020151/2	160	194				
	L 30	E2020301/2	187	233				
	L 40	E2020401/2	209	262				
	L 45	E2020451/2	219	277				
	L 60	E2020601/2	256	325				
	L 65	E2020651/2	267	341				
 <p>cestello estraibile chiusura soft pull-out basket unit soft-closing system</p>								
	H 72 L 15	E2010150	179	209				
	H 96 L 15	E2020150	213	247				



PENSILI

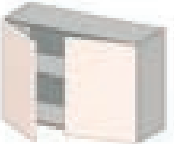
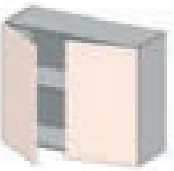

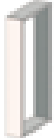
WALL UNITS

P 33,2

		COD.	FASCIA A K80	FASCIA B K80			
 <p>2 ante H 36 2 doors H 36</p>							
	L 90	E2030900	249	320			
 <p>2 ante H 48 2 doors H 48</p>							
	L 90	E2040900	285	366			
 <p>2 ante H 60 2 doors H 60</p>							
	L 90	E2060900	303	393			
 <p>2 ante H 72 2 doors H 72</p>							
	L 60	E2010600	276	358			
	L 80	E2010800	310	404			
	L 90	E2010900	319	416			
 <p>2 ante H 96 2 doors H 96</p>							
	L 60	E2020600	321	417			
	L 80	E2020800	366	477			
	L 90	E2020900	386	506			
 <p>fascia tamponamento L da 3 a 10 filler panel size from 3 to 10</p>							
	H 60	E2790000	107	140			
	H 72	E2800000	107	140			
	H 96	E2810000	133	175			

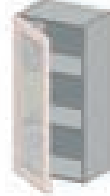
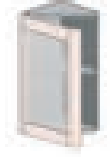
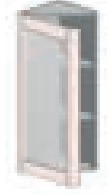
PENSILI
SCOLAPIATTI
WALL-PLATE RACK UNITS

	COD.	FASCIA A K80	FASCIA B K80				
 <p>1 anta vetro H 36 1 glass door H 36</p>							
	L 45 E1030451/2	204	258				
	L 60 E1030601/2	227	289				
 <p>1 anta vetro H 48 1 glass door H 48</p>							
	L 45 E1040451/2	229	290				
	L 60 E1040601/2	258	328				
 <p>1 anta vetro H 72 1 glass door H 72</p>							
	L 45 E1010451/2	255	327				
	L 60 E1010601/2	294	381				
 <p>1 anta vetro H 96 1 glass door H 96</p>							
	L 45 E1020451/2	305	393				
	L 60 E1020601/2	350	458				
 <p>terminale 33,6X33,6 H 72 1 anta vetro tipo "C" end unit 33,6X33,6 H 72 1 glass door type "C"</p>							
	H 72 E1640311/2	364	500				
 <p>terminale 33,6X33,6 H 96 1 anta vetro tipo "C" end unit 33,6X33,6 H 96 1 glass door type "C"</p>							
	H 96 E1650311/2	445	611				

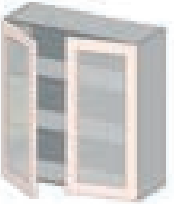





		COD.	FASCIA A K80	FASCIA B K80				
 <p>2 ante vetro H 36 2 glass doors H 36</p>								
	L 90	E1030900	367	480				
 <p>2 ante vetro H 48 2 glass doors H 48</p>								
	L 90	E1040900	412	538				
 <p>2 ante vetro H 72 2 glass doors H 72</p>								
	L 90	E1010900	468	616				
 <p>2 ante vetro H 96 2 glass doors H 96</p>								
	L 90	E1020900	558	737				

		COD.	FASCIA A K80	FASCIA B K80				
 <p>angolo H 72 1 anta diagonale corner unit H 72 1 diagonal door</p>	65X65	E2400651/2	262	312				
 <p>angolo H 96 1 anta diagonale corner unit H 96 1 diagonal door</p>	65X65	E2410651/2	313	375				
 <p>angolo H 72 2 ante a libretto N.B.: non si effettuano fuori squadra corner unit H 72 2 folding doors Note: out-of-plumb units unavailable</p>	65X65	E2450651/2	377	461				
 <p>angolo H 96 2 ante a libretto N.B.: non si effettuano fuori squadra corner unit H 96 2 folding doors Note: out-of-plumb units unavailable</p>	65X65	E2460651/2	446	549				
 <p>angolo H 72 1 anta N.B.: fuori squadra realizzabili da 88° a 94° corner unit H 72 1 door Note: out-of-plumb units available from 88° to 94°</p> <p>verso dx RH version</p>	65X35	E2491651/2	327	409				
 <p>angolo H 96 1 anta N.B.: fuori squadra realizzabili da 88° a 94° corner unit H 96 1 door Note: out-of-plumb units available from 88° to 94°</p> <p>verso dx RH version</p>	65X35	E2495651/2	399	494				

PENSILI

WALL UNITS

P 33,2 - 47,2 - 59,7

		COD.	FASCIA A K80	FASCIA B K80				
 <p>copriboiler H 72 1 anta boiler housing H 72 1 door</p>	P 33,2 L 60	E2150601/2	206	267				
	L 65	E2150651/2	216	281				
	P 47,2 L 60	E2160601/2	240	309				
	L 65	E2160651/2	249	321				
	P 59,7 L 60	E2170601/2	240	309				
	L 65	E2170651/2	249	321				
 <p>copriboiler H 96 1 anta boiler housing H 96 1 door</p>	P 33,2 L 60	E2210601/2	240	314				
	L 65	E2210651/2	252	331				
	P 47,2 L 60	E2220601/2	310	392				
	L 65	E2220651/2	322	409				
	P 59,7 L 60	E2230601/2	310	392				
	L 65	E2230651/2	322	409				
 <p>jolly pensile H 72 L da 10 a 30 jolly wall unit H 72 size from 10 to 30</p>	in nobilitato melamine coated	E2700000	128	128				
	impiallacciato veneered	E2720000	258	258				
 <p>jolly pensile H 96 L da 10 a 30 jolly wall unit H 96 size from 10 to 30</p>	in nobilitato melamine coated	E2710000	153	153				
	impiallacciato veneered	E2730000	308	308				
 <p>terminale 31x31 H 72 a giorno tipo "C" 1 ripiano open end unit 31x31 H 72 type "C" 1 shelf</p>	in nobilitato melamine coated	E2640310	97	97				
	impiallacciato veneered	E2641310	271	271				
 <p>terminale 31x31 H 96 a giorno tipo "C" 2 ripiani open end unit 31x31 H 96 type "C" 2 shelves</p>	in nobilitato melamine coated	E2650310	114	114				
	impiallacciato veneered	E2651310	311	311				

PENSILI RIBALTA CHIUSURA AMMORTIZZATA

FLAP DOOR WALL UNITS BLUMOTION CLOSING SYSTEM

PENSILE CON APERTURA A RIBALTA

Le ante aprendosi verso l'alto consentono di avere un' ampia visione d'insieme all'interno del mobile. In questo modo è possibile un comodo accesso agli oggetti contenuti al suo interno e, dal punto di vista ergonomico, molto vantaggioso. La regolazione della forza di apertura può essere impostata in modo esatto in base al peso del frontale. Grazie all'arresto progressivo le ante si fermano in qualsiasi posizione; in questo modo la maniglia è sempre facilmente raggiungibile. La chiusura è ammortizzata di serie.

WALL UNIT WITH FLAP DOOR

The doors that open upwards guarantee ample overall visibility inside the cabinet. In this way, all objects housed inside the cabinet can be comfortably accessed, making the system highly advantageous from an ergonomic perspective. The opening force can be adjusted precisely according to the weight of the front. The doors stop in any position thanks to the gradual stopping movement; in this way, the handle is always easily accessible. The closing movement is cushioned standard

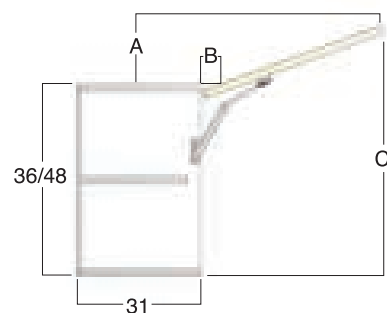







	A	B	C
H 36	10	2,3	46
H 48	13	2,3	61

PENSILI RIBALTA CHIUSURA BLUMOTION

FLAP DOOR WALL UNITS BLUMOTION CLOSING SYSTEM



P 33,2

		COD.	FASCIA A K80	FASCIA B K80				
 <p>anta ribalta H 36 flap door H 36</p>								
	L 45	E2100450	163	198				
	L 60	E2100600	174	213				
	L 90	E2100900	217	266				
 <p>anta ribalta H 48 flap door H 48</p>								
	L 45	E2120450	186	226				
	L 60	E2120600	212	257				
	L 90	E2120900	252	309				
 <p>anta vetro ribalta H 36 glass flap door H 36</p>								
	L 45	E1100450	219	273				
	L 60	E1100600	235	295				
	L 90	E1100900	293	368				
 <p>anta vetro ribalta H 48 glass flap door H 48</p>								
	L 45	E1120450	237	295				
	L 60	E1120600	277	344				
	L 90	E1120900	341	428				
 <p>pensile H 72 vano a giorno con cornice sagomata 1 anta a ribalta H 36 wall unit H 72 open unit with shaped frame 1 flap door H 36</p>								
	L 60	E2081600	249	315				
	L 90	E2081900	263	343				
				+280	+280			
 <p>pensile H 72 vano a giorno con cornice sagomata 1 anta vetro a ribalta H 36 wall unit H 72 open unit with shaped frame 1 glass flap door H 36</p>								
	L 60	E2082600	310	396				
	L 90	E2082900	339	446				
				+280	+280			



Grazie al meccanismo TIP-ON, le ante a ribalta senza maniglia possono essere aperte semplicemente con un leggero tocco. Per chiudere l'anta a ribalta, è sufficiente esercitare una leggera pressione, che grazie ad una piastrina di bloccaggio, applicata sul lato interno del frontale, ne assicura la perfetta chiusura.

Thanks to TIP-ON mechanism, the flap doors without handles can be opened with a simple touch. To close the flap door, just exercise light pressure, thanks to the locking plate, applied on the inner side of the front panel ensures a perfect closure.

	COD.	FASCIA A K80	FASCIA B K80				
<p>anta ribalta TIP-ON H 36 flap door TIP-ON H 36</p> 	L 45	E210046T	170	204			
	L 60	E210061T	180	219			
	L 90	E210091T	223	272			
<p>anta ribalta TIP-ON H 48 flap door TIP-ON H 48</p> 	L 45	E212046T	193	233			
	L 60	E212061T	220	265			
	L 90	E212091T	259	317			

PENSILI APERTURA A PACCHETTO

WALL UNITS FOLDING DOORS

PENSILE CON APERTURA ANTE A PACCHETTO

Il meccanismo d'apertura ante a pacchetto è idoneo sia sul pensile H 72 che H 96; la regolazione della forza di apertura può essere impostata in modo esatto in base ai pesi dei frontali, la chiusura è ammortizzata e la cerniera centrale clip si contraddistingue per l'innovativa tecnologia che garantisce la sicurezza per le dita.

WALL UNIT WITH LIFT-UP FOLDING DOORS

The lift-up folding door opening mechanism is suitable for wall units with H 72 or H 96; the opening force can be adjusted precisely according to the weight of the fronts, while the closing movement is cushioned and the central clip-on hinge features innovative technology for safeguarding the fingers.



H 72



H 96

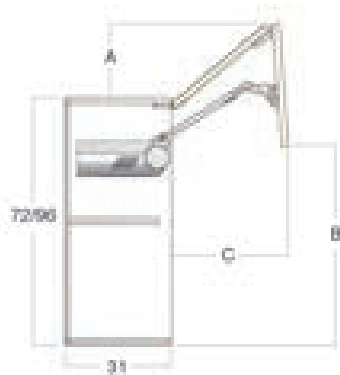



	A	B	C
H 72	19,5	54	41
H 96	24,7	69	53

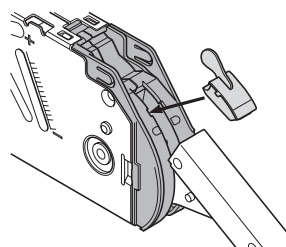
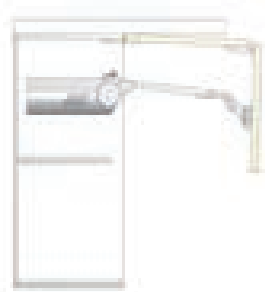



SCHEMA MONTAGGIO LIMITATORE LIMITER INSTALLATION DIAGRAM

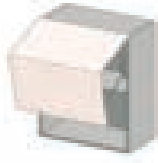
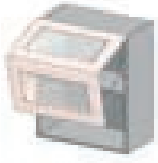

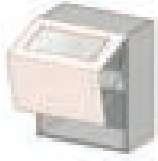
Per evitare l'interferenza dell'anta in fase di apertura con cornici o mensole, si può richiedere il limitatore dell'angolo di apertura cod. 5620005 € 10

In order to avoid that the door interferes with cornices or shelves during the opening movement, it is possible to request an opening angle limiter: code 5620005 € 10



	COD.	FASCIA A K80	FASCIA B K80				
 <p>pensile H 72 apertura a pacchetto 2 ante H 36 wall unit H 72 lift-up folding door 2 doors H 36</p>	L 45	E2070450	350	421			
	L 60	E2070600	377	458			
	L 90	E2070900	435	537			
 <p>pensile H 72 apertura a pacchetto 2 ante vetro H 36 wall unit H 72 lift-up folding door 2 glass doors H 36</p>	L 45	E1070450	457	564			
	L 60	E1070600	499	622			
	L 90	E1070900	589	743			
 <p>pensile H 72 apertura a pacchetto 1 anta chiusa superiore H 36 1 anta vetro inferiore H 36 wall unit H 72 lift-up folding door 1 full upper door H 36 1 glass lower door H 36</p>	L 45	E2075450	403	493			
	L 60	E2075600	438	540			
	L 90	E2075900	512	640			
 <p>pensile H 72 apertura a pacchetto 1 anta vetro superiore H 36 1 anta chiusa inferiore H 36 wall unit H 72 lift-up folding door 1 glass upper door H 36 1 full lower door H 36</p>	L 45	E2077450	403	493			
	L 60	E2077600	438	540			
	L 90	E2077900	512	640			







	COD.	FASCIA A K80	FASCIA B K80				
 <p>pensile H 96 apertura a pacchetto 2 ante H 48 wall unit H 96 lift-up folding door 2 doors H 48</p>							
	L 45	E2090450	396	477			
	L 60	E2090600	431	524			
	L 90	E2090900	505	625			
 <p>pensile H 96 apertura a pacchetto 2 ante vetro H 48 wall unit H 96 lift-up folding door 2 glass doors H 48</p>							
	L 60	E1090600	557	696			
	L 90	E1090900	671	849			
 <p>pensile H 96 apertura a pacchetto 1 anta chiusa superiore H 48 1 anta vetro inferiore H 48 wall unit H 96 lift-up folding door 1 full upper door H 48 1 glass lower door H 48</p>							
	L 60	E2092600	494	610			
	L 90	E2092900	588	737			
 <p>pensile H 96 apertura a pacchetto 1 anta vetro superiore H 48 1 anta chiusa inferiore H 48 wall unit H 96 lift-up folding door 1 glass upper door H 48 1 full lower door H 48</p>							
	L 60	E2096600	494	610			
	L 90	E2096900	588	737			



PENSILI PER MICRO

WALL UNITS FOR MICROWAVE OVENS

P 33,2

	COD.	FASCIA A K80	FASCIA B K80				
 <p>pensile H 72 1 anta ribalta H 36 vano per micro Whirlpool wall unit H 72 1 flap door H 36 housing for Whirlpool microwave</p>							
	L 60 EPM20600	200	239				
 <p>pensile H 72 1 anta vetro ribalta H 36 vano per micro Whirlpool wall unit H 72 1 glass flap door H 36 housing for Whirlpool microwave</p>							
	L 60 EPM10600	261	321				
 <p>pensile H 96 1 anta H 60 vano per micro Whirlpool wall unit H 96 1 door H 60 housing for Whirlpool microwave</p>							
	L 60 EPM25601/2	224	275				







		COD.	FASCIA A K80	FASCIA B K80			
 <p>soprapensile H 36 1 anta top unit H 36 1 door</p>	L 45	E2063451/2	195	234			
	L 60	E2063601/2	214	258			
 <p>soprapensile H 48 1 anta top unit H 48 1 door</p>	L 45	E2064451/2	228	271			
	L 60	E2064601/2	252	302			
 <p>soprapensile H 60 1 anta top unit H 60 1 door</p>	L 45	E2065451/2	245	294			
	L 60	E2065601/2	274	330			
 <p>soprapensile H 36 2 ante top unit H 36 2 doors</p>	L 90	E2063900	313	389			
 <p>soprapensile H 48 2 ante top unit H 48 2 doors</p>	L 90	E2064900	364	450			
 <p>soprapensile H 60 2 ante top unit H 60 2 doors</p>	L 90	E2065900	394	491			





	COD.	FASCIA A K80	FASCIA B K80				
<p>soprapensile H 36 1 anta vetro ribalta top unit H 36 1 glass flap door</p> 							
	L 60 E1101600	299	363				
	L 90 E1101900	353	432				
<p>soprapensile H 48 1 anta ribalta top unit H 48 1 flap door</p> 							
	L 60 E2128600	287	336				
	L 90 E2128900	336	398				
<p>soprapensile H 48 1 anta vetro ribalta top unit H 48 1 glass flap door</p> 							
	L 60 E1128600	352	423				
	L 90 E1128900	421	512				

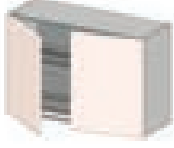

SCOLAPIATTI GRIGLIE ORION GRAU E RACCOGLIGOCCE PLASTICA

P 33,2

PLATE RACK UNITS ORION GRAU GRILLES AND PLASTIC DRIP TRAY



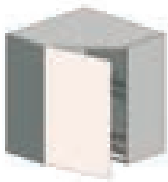
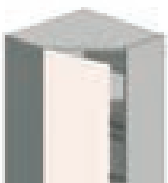



		COD.	FASCIA A K80	FASCIA B K80			
 <p>1 anta H 60 1 door H 60</p>							
	L 60	E3060601/2	226	277			
 <p>1 anta H 72 1 door H 72</p>							
	L 45	E3010451/2	214	260			
	L 60	E3010601/2	241	299			
	L 75	E3010751/2	288	354			
 <p>1 anta H 96 1 door H 96</p>							
	L 45	E3020451/2	252	309			
	L 60	E3020601/2	291	361			
 <p>1 anta vetro H 72 1 glass door H 72</p>							
	L 45	E3210451/2	288	360			
	L 60	E3210601/2	327	414			
 <p>1 anta vetro H 96 1 glass door H 96</p>							
	L 45	E3220451/2	337	425			
	L 60	E3220601/2	386	494			
 <p>Maggiorazione kit luce LED DUAL COLOR calda (2700K) e naturale (4200K) interruttore ON/OFF "Touch" a sfioramento con alimentatore incluso Surcharge DUAL COLOR LED light kit warm (2700K) and natural (4200K) "Soft Touch" switch ON/OFF with power supplier</p>		opz.005					
	L 45		+100	+100			
	L 60		+105	+105			
	L 65		+105	+105			
	L 75		+115	+115			
	L 80		+115	+115			
	L 90		+115	+115			
	L 120		+135	+135			

	COD.	FASCIA A K80	FASCIA B K80				
 <p>2 ante H 60 2 doors H 60</p>	L 90	E3060900	346	437			
 <p>2 ante H 72 2 doors H 72</p>	L 60	E3010600	315	397			
	L 80	E3010800	352	446			
	L 90	E3010900	363	459			
 <p>2 ante H 96 2 doors H 96</p>	L 60	E3020600	360	455			
	L 80	E3020800	407	519			
	L 90	E3020900	430	549			
 <p>2 ante vetro H 72 2 glass doors H 72</p>	L 90	E3210900	511	660			
 <p>2 ante vetro H 96 2 glass doors H 96</p>	L 90	E3220900	601	780			

		COD.	FASCIA A K80	FASCIA B K80			
 <p>angolo H 72 1 anta diagonale N.B.: non si effettuano fuori squadra corner unit H 72 1 diagonal door Note: out-of-plumb units unavailable</p>	65X65	E3400651/2	452	503			
 <p>angolo H 96 1 anta diagonale N.B.: non si effettuano fuori squadra corner unit H 96 1 diagonal door Note: out-of-plumb units unavailable</p>	65X65	E3410651/2	508	570			
 <p>angolo H 72 2 ante a libretto N.B.: non si effettuano fuori squadra corner unit H 72 2 folding doors Note: out-of-plumb units unavailable</p>	65X65	E3450651/2	554	643			
 <p>angolo H 96 2 ante a libretto N.B.: non si effettuano fuori squadra corner unit H 96 2 folding doors Note: out-of-plumb units unavailable</p>	65X65	E3460651/2	632	735			
 <p>Maggiorazione kit luce LED DUAL COLOR calda (2700K) e naturale (4200K) interruttore ON/OFF "Touch" a sfioramento con alimentatore incluso Surcharge DUAL COLOR LED light kit warm (2700K) and natural (4200K) "Soft Touch" switch ON/OFF with power supplier</p>							
		opz.005					
	L 45		+100	+100			
	L 60		+105	+105			
	L 65		+105	+105			
	L 75		+115	+115			
	L 80		+115	+115			
	L 90		+115	+115			
L 120		+135	+135				

SCOLAPIATTI RIBALTA CHIUSURA BLUMOTION



FLAP-DOOR PLATE RACK UNITS BLUMOTION CLOSING SYSTEM



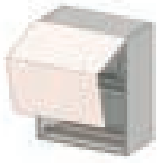
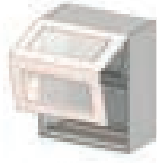

		COD.	FASCIA A K80	FASCIA B K80					
 <p>anta ribalta H 36 griglie orion grau e raccogliocce plastica flap door H 36 orion grau grilles and plastic drip tray</p>	L 60	E3100600	201	239					
	L 90	E3100900	253	302					
 <p>anta ribalta H 48 griglie orion grau e raccogliocce plastica flap door H 48 orion grau grilles and plastic drip tray</p>	L 60	E3120600	230	274					
	L 90	E3120900	275	333					
 <p>anta vetro ribalta H 36 griglie orion grau e raccogliocce plastica glass flap door H 36 orion grau grilles and plastic drip tray</p>	L 60	E3130600	262	321					
	L 90	E3130900	329	404					
 <p>anta vetro ribalta H 48 griglie orion grau e raccogliocce plastica glass flap door H 48 orion grau grilles and plastic drip tray</p>	L 60	E3140600	294	362					
	L 90	E3140900	360	447					
 <p>scolapiatti H 72 vano a giorno con cornice sagomata 1 anta ribalta H 36 griglie orion grau e raccogliocce plastica plate rack unit H 72 open unit with shaped frame 1 flap door H 36 orion grau grilles and plastic drip tray</p>	L 60	E3091600	275	340					
	L 90	E3091900	309	389					
				+280	+280				
 <p>scolapiatti H 72 vano a giorno con cornice sagomata 1 anta vetro a ribalta H 36 griglie orion grau e raccogliocce plastica plate rack unit H 72 open unit with shaped frame 1 glass flap door H 36 orion grau grilles and plastic drip tray</p>	L 60	E3092600	336	422					
	L 90	E3092900	391	497					
				+280	+280				

SCOLAPIATTI APERTURA A PACCHETTO CHIUSURA BLUMOTION

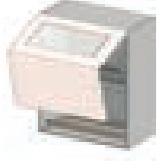
P 33,2

PLATE RACK UNITS LIFT-UP FOLDING DOOR AND BLUMOTION CLOSING SYSTEM

	COD.	FASCIA A K80	FASCIA B K80				
 <p>scolapiatti H 72 apertura a pacchetto 2 ante H 36 griglie orion grau e raccogliocce plastica plate rack unit H 72 lift-up folding door 2 doors H 36 orion grau grilles and plastic drip tray</p>	L 45	E3081450	373	445			
	L 60	E3081600	400	481			
	L 90	E3081900	464	566			
 <p>scolapiatti H 72 apertura a pacchetto 2 ante vetro H 36 griglie orion grau e raccogliocce plastica plate rack unit H 72 lift-up folding door 2 glass doors H 36 orion grau grilles and plastic drip tray</p>	L 45	E3270450	480	588			
	L 60	E3270600	522	644			
	L 90	E3270900	617	771			
 <p>scolapiatti H 72 apertura a pacchetto 1 ante chiusa superiore H 36 1 ante vetro inferiore H 36 griglie orion grau e raccogliocce plastica plate rack unit H 72 lift-up folding door 1 full upper door H 36 1 glass lower door H 36 orion grau grilles and plastic drip tray</p>	L 45	E3085450	427	516			
	L 60	E3085600	461	563			
	L 90	E3085900	541	669			
 <p>scolapiatti H 72 apertura a pacchetto 1 ante vetro superiore H 36 1 ante chiusa inferiore H 36 griglie orion grau e raccogliocce plastica plate rack unit H 72 lift-up folding door 1 glass upper door H 36 1 full lower door H 36 orion grau grilles and plastic drip tray</p>	L 45	E3087600	461	563			
	L 60	E3087600	461	563			
	L 90	E3087900	541	669			



	COD.	FASCIA A K80	FASCIA B K80				
 <p>scolapiatti H 96 apertura a pacchetto 2 ante H 48 griglie orion grau e raccogliocce plastica plate rack unit H 96 lift-up folding door 2 doors H 48 orion grau grilles and plastic drip tray</p>	L 45	E3094450	419	500			
	L 60	E3094600	452	546			
	L 90	E3094900	532	651			
 <p>scolapiatti H 96 apertura a pacchetto 2 ante vetro H 48 griglie orion grau e raccogliocce plastica plate rack unit H 96 lift-up folding door 2 glass doors H 48 orion grau grilles and plastic drip tray</p>	L 60	E3290600	579	718			
	L 90	E3290900	698	876			
 <p>scolapiatti H 96 apertura a pacchetto 1 anta chiusa superiore H 48 1 anta vetro inferiore H 48 griglie orion grau e raccogliocce plastica plate rack unit H 96 lift-up folding door 1 full upper door H 48 1 glass lower door H 48 orion grau grilles and plastic drip tray</p>	L 60	E3095600	516	632			
	L 90	E3095900	615	764			
 <p>scolapiatti H 96 apertura a pacchetto 1 anta vetro superiore H 48 1 anta chiusa inferiore H 48 griglie orion grau e raccogliocce plastica plate rack unit H 96 lift-up folding door 1 glass upper door H 48 1 full lower door H 48 orion grau grilles and plastic drip tray</p>	L 60	E3097600	516	632			
	L 90	E3097900	615	764			



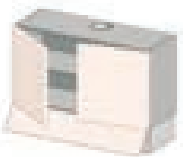

CAPPE ASPIRANTI

EXTRACTOR HOODS

P 33,2

CAPPE
HOODS

	COD.	FASCIA A K80	FASCIA B K80				
 <p>cappa estraibile 2 motori portata 275 m³/h con laterali in metallo, 1 anta N.B.: posizionare la cappa ad una distanza non inferiore ai 65 cm dal piano cottura</p> <p>slide-out hood 2 motors air flow rate 275 m³/h with metal sides, 1 door Note: position the hood at least 65 cm from the cooker hob</p>	H 63 L 60	E3600601/2	379	442			
	H 87 L 60	E3610601/2	413	488			
	n° 2 filtri carbone attivo 2 active carbon filters		+24	+24			
 <p>cappa estraibile 2 motori portata 275 m³/h con laterali in metallo, 2 ante N.B.: posizionare la cappa ad una distanza non inferiore ai 65 cm dal piano cottura</p> <p>slide-out 2 motors air flow rate 275 m³/h with metal sides, 2 doors Note: position the hood at least 65 cm from the cooker hob</p>	H 63 L 90	E3600900	508	614			
	H 87 L 90	E3610900	549	671			
	n° 2 filtri carbone attivo 2 active carbon filters		+24	+24			
 <p>cappa "Mod. F" integrata totale con frontalino vetro estraibile portata 390 m³/h con faretti a led 1 anta N.B.: posizionare la cappa ad una distanza non inferiore ai 55 cm dal piano cottura</p> <p>"Mod. F" fully integrated hood with glass pull-out frontal panel air flow rate 390 m³/h, with led lights 1 door Note: position the hood at least 55 cm from the cooker hob</p>	H 60 L 60	EPC90461/2	547	598			
	H 72 L 60	EPC90561/2	560	617			
	H 96 L 60	EPC90661/2	606	675			
	n° 2 filtri carbone attivo 2 active carbon filters	08750894	31	31			
 <p>cappa "Mod. F" integrata totale con frontalino vetro estraibile portata 390 m³/h con faretti a led 2 ante N.B.: posizionare la cappa ad una distanza non inferiore ai 55 cm dal piano cottura</p> <p>"Mod. F" fully integrated hood with glass pull-out front panel air flow rate 390 m³/h with led lights 2 doors Note: position the hood at least 55 cm from the cooker hob</p>	H 60 L 90	EPC90490	671	762			
	H 72 L 90	EPC90590	685	781			
	H 96 L 90	EPC90690	749	869			
	n° 2 filtri carbone attivo 2 active carbon filters	08750894	31	31			

		COD.	FASCIA A K80	FASCIA B K80				
 <p>cappa "Mod. F" integrata totale con frontalino vetro estraibile portata 390 m³/h con faretti a led 1 anta apertura a ribalta N.B.: posizionare la cappa ad una distanza non inferiore ai 55 cm dal piano cottura</p> <p>"Mod. F" fully integrated hood with glass pull-out front panel air flow rate 390 m³/h with led lights 1 flap door Note: position the hood at least 55 cm from the cooker hob</p>	H 36 L 60	EPC80260	533	571				
	H 36 L 90	EPC80290	595	644				
	H 48 L 60	EPC80360	772	817				
	H 48 L 90	EPC80390	827	885				
	n° 2 filtri carbone attivo 2 active carbon filters	08750894	31	31				
 <p>cappa "Mod. F" integrata totale con frontalino vetro estraibile portata 390 m³/h con faretti a led 2 ante apertura a pacchetto N.B.: posizionare la cappa ad una distanza non inferiore ai 55 cm dal piano cottura</p> <p>"Mod. F" fully integrated hood with glass pull-out front panel air flow rate 390 m³/h with led lights 2 lift-up folding doors Note: position the hood at least 55 cm from the cooker hob</p>	H 72 L 60	EPC83560	733	814				
	H 72 L 90	EPC83590	809	911				
	H 96 L 60	EPC83660	789	883				
	H 96 L 90	EPC83690	882	1.001				
	n° 2 filtri carbone attivo 2 active carbon filters	08750894	31	31				
 <p>Maggiorazione cappa "NO DRIP" incasso pensile portata 600 m³/h, per piano cottura ad induzione classe energetica A</p> <p>Surcharge "NO DRIP" built in hood air flow rate 600 m³/h recommended for induction cooker hob energetic class A</p>	L 60	opz.006	+559	+559				
	L 90	opz.006	+559	+559				
	filtro carbone attivo active carbon filter	08750844R	+42	+42				
 <p>PERCHÈ LA CAPP "NO DRIP": a differenza dei tradizionali piani cottura a gas dove la fiamma riscalda le superfici della cappa, nei piani cottura ad induzione i vapori condensano velocemente sulle superfici "fredde" della stessa, generando così gocce d'acqua che cadono sul p.c. sottostante. LA CAPP "NO DRIP" È LA SOLUZIONE A QUESTO PROBLEMA.</p> <p>WHY THE "NO DRIP" HOOD: unlike traditional gas hobs where the flame heats the surfaces of the hood, with induction hobs the vapors quickly condense on the "cold" surfaces of the hood, thus generating drops of water that fall on the hob below. THE "NO DRIP" HOOD IS THE SOLUTION TO THIS PROBLEM.</p>								

CAPPA DESIRÈ

DESIRÈ HOOD

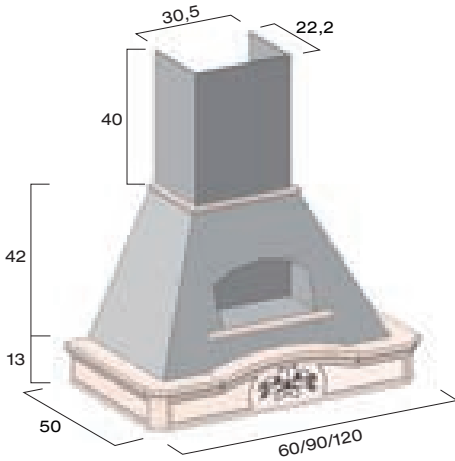
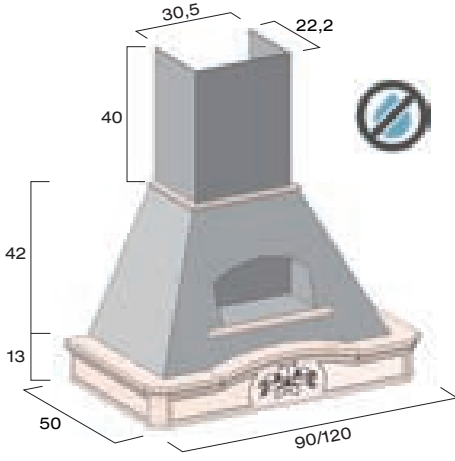

	COD.	€ K80				
<p>cappa DESIRÈ con camino metallo in tinta e nicchia portata 645 m³/h, fascione e cornice in massello, colore come anta impiallacciata</p> <p>DESIRÈ hood with metal chimney matching with band and niche air flow rate 645 m³/h, band and cornice in solid wood, same colour as veneered door</p> 						
<p>bianco L 60</p>	03993850B	703				
<p>L 90</p>	03993851B	937				
<p>L 120</p>	03993852B	1.069				
<p>silver dark L 60</p>	03993850S	802				
<p>L 90</p>	03993851S	1.054				
<p>L 120</p>	03993852S	1.185				
<p>ottone L 60</p>	03993850T	802				
<p>L 90</p>	03993851T	1.054				
<p>L 120</p>	03993852T	1.185				
<p>filtra carbone attivo L 60 active carbon filter</p>	08750999G	61				
<p>filtra carbone attivo L 90-120 active carbon filter</p>	08750999B	28				
<p>cappa DESIRÈ con camino metallo in tinta e nicchia, NO DRIP portata 350 m³/h, fascione e cornice in massello, colore come anta impiallacciata</p> <p>DESIRÈ hood with metal chimney matching with band and niche, NO DRIP air flow rate 350 m³/h, band and cornice in solid wood, same colour as veneered door</p> 						
<p>bianco L 90</p>	03993856B	2.249				
<p>L 120</p>	03993857B	2.379				
<p>silver dark L 90</p>	03993856S	2.364				
<p>L 120</p>	03993857S	2.494				
<p>ottone L 90</p>	03993856T	2.364				
<p>L 120</p>	03993857T	2.494				
<p>filtra carbone attivo active carbon filter</p>	08750999F	56				

CAPPA EGIZIA

EGIZIA HOOD



cappa EGIZIA con camino metallo in tinta e orologio
portata 645 m³/h, fascione e cornice in massello, colore come anta
impiallacciata

EGIZIA hood with metal chimney matching with band and clock
 air flow rate 645 m³/h, band and cornice in solid wood, same colour as veneered door

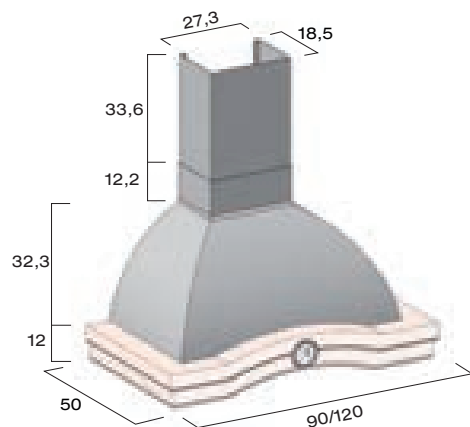

- bianco L 90
- L 120
- silver dark L 90
- L 120
- ottone L 90
- L 120
- filtro carbone attivo
active carbon filter

COD.	€ K80					
03993861B	901					
03993862B	978					
03993861S	1.019					
03993862S	1.095					
03993861T	1.019					
03993862T	1.095					
08750999B	28					

cappa EGIZIA con camino metallo in tinta e orologio, NO DRIP
portata 350 m³/h, fascione e cornice in massello, colore come anta
impiallacciata

EGIZIA hood with metal chimney matching with band and clock, NO DRIP
 air flow rate 350 m³/h, band and cornice in solid wood, same colour as veneered door

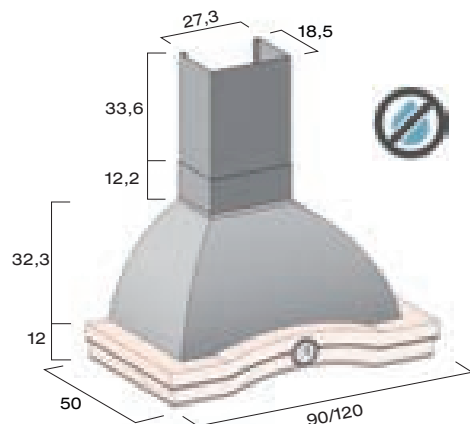

- bianco L 90
- L 120
- silver dark L 90
- L 120
- ottone L 90
- L 120
- filtro carbone attivo
active carbon filter

03993866B	2.214					
03993867B	2.289					
03993866S	2.330					
03993867S	2.404					
03993866T	2.330					
03993867T	2.404					
08750999F	56					

CAPPA PORTRAIT

PORTRAIT HOOD

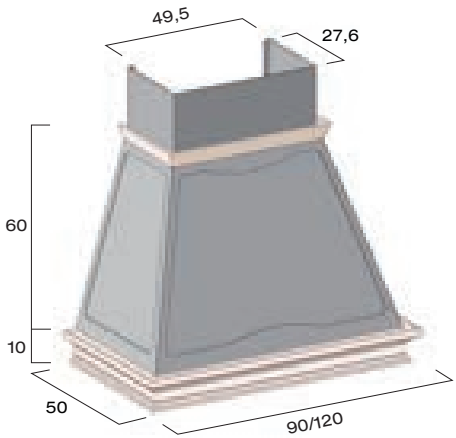
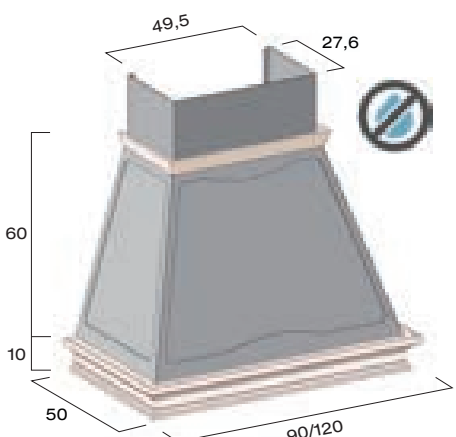

	COD.	€ K80				
<p>cappa PORTRAIT con camino metallo in tinta portata 645 m³/h, fascione e cornice in massello, colore come anta impiallacciata PORTRAIT hood with metal chimney matching with band air flow rate 645 m³/h, band and cornice in solid wood, same colour as veneered door</p> 						
<p>bianco L 90</p>	03993871B	1.264				
<p>L 120</p>	03993872B	1.529				
<p>silver dark L 90</p>	03993871S	1.381				
<p>L 120</p>	03993872S	1.643				
<p>ottone L 90</p>	03993871T	1.381				
<p>L 120</p>	03993872T	1.643				
<p>filtro carbone attivo active carbon filter</p>	08750999B	28				
<p>cappa PORTRAIT con camino metallo in tinta, NO DRIP portata 350 m³/h, fascione e cornice in massello, colore come anta impiallacciata PORTRAIT hood with metal chimney matching with band, NO DRIP air flow rate 350 m³/h, band and cornice in solid wood, same colour as veneered door</p> 						
<p>bianco L 90</p>	03993876B	2.571				
<p>L 120</p>	03993877B	2.854				
<p>silver dark L 90</p>	03993876S	2.687				
<p>L 120</p>	03993877S	2.970				
<p>ottone L 90</p>	03993876T	2.687				
<p>L 120</p>	03993877T	2.970				
<p>filtro carbone attivo active carbon filter</p>	08750999F	56				

CAPPA VIENNA

VIENNA HOOD

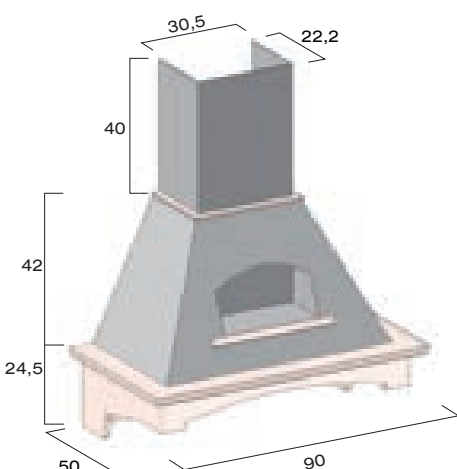
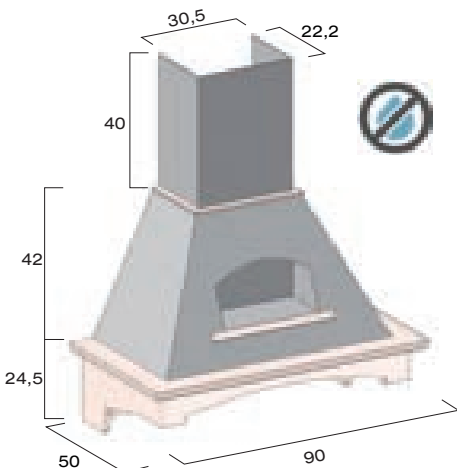

	COD.	€ K80				
<p>cappa VIENNA con camino metallo in tinta e nicchia portata 645 m³/h, fascione e cornice in massello, colore come anta impiallacciata VIENNA hood with metal chimney matching with band and niche air flow rate 645 m³/h, band and cornice in solid wood, same colour as veneered door</p> 						
	L 90					
	bianco	03993881B	901			
	silver dark	03993881S	1.019			
	ottone	03993881T	1.019			
	filtro carbone attivo active carbon filter	08750999B	28			
<p>cappa VIENNA con camino metallo in tinta e nicchia portata 350 m³/h, fascione e cornice in massello, colore come anta impiallacciata VIENNA hood with metal chimney matching with band and niche air flow rate 350 m³/h, band and cornice in solid wood, same colour as veneered door</p> 						
	L 90					
	bianco	03993886B	2.214			
	silver dark	03993886S	2.330			
	ottone	03993886T	2.330			
	filtro carbone attivo active carbon filter	08750999F	56			



TIPOLOGIE CAPPE CAMINO

CHIMNEY HOOD TYPES

cappa tipo "S" vedi pag. 52

chimney type "S"
see page 52



cappa tipo "S2" vedi pag. 54

chimney type "S2"
see page 54



cappa tipo "E" vedi pag. 56

chimney type "E"
see page 56



cappa tipo "SN" vedi pag. 58

chimney type "SN"
see page 58



TIPOLOGIE CAPPE CAMINO

CHIMNEY HOOD TYPES

cappa isola
vedi pag. 59

chimney island
see page 59



SCHEMA CAPPA CAMINETTO AD ANGOLO

CORNER CHIMNEY HOOD DIAGRAM

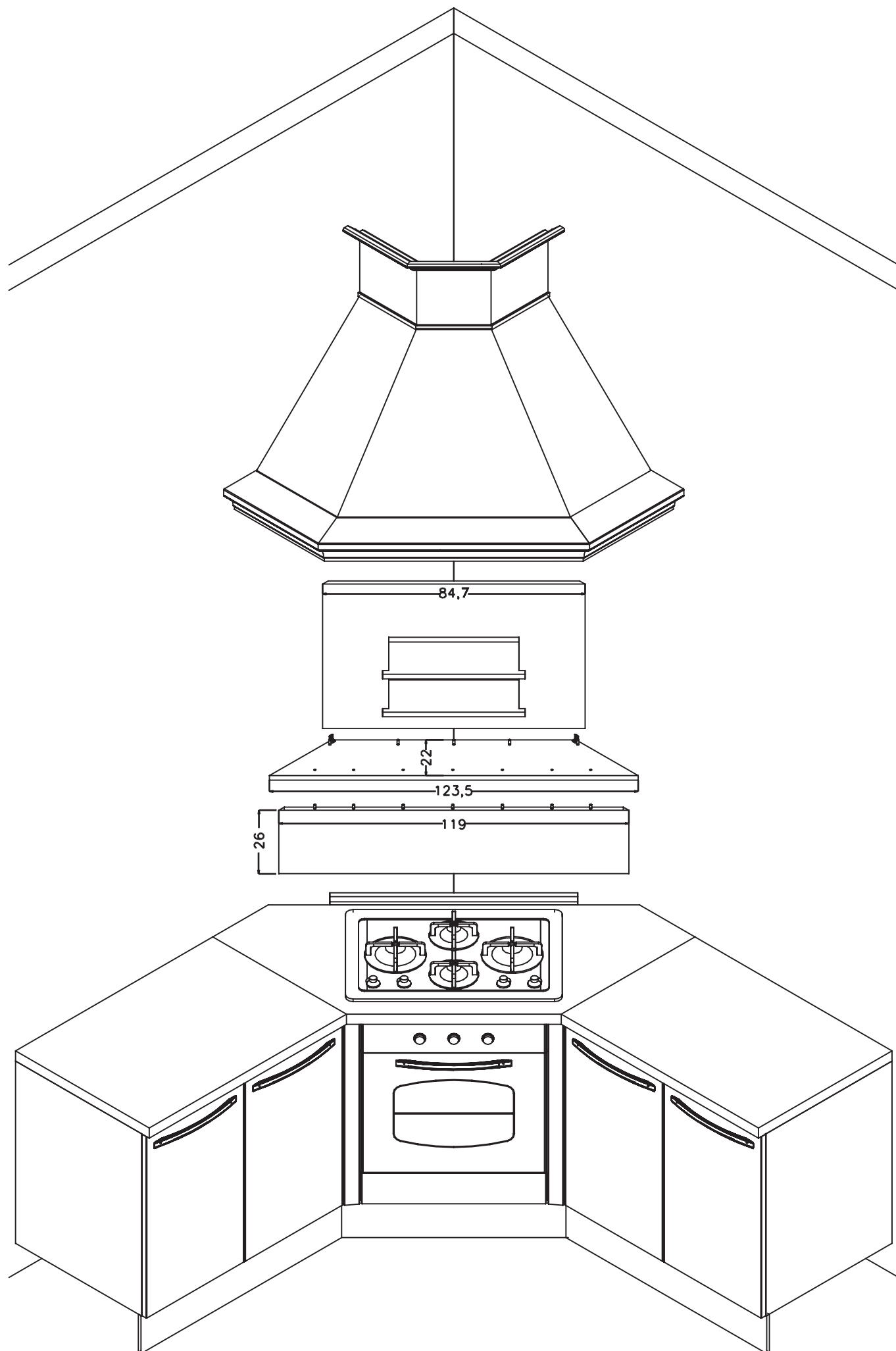

CAPPE FASCIONE TIPO "S" CAMINO BUCCIATO

HOOD BAND TYPE "S" TEXTURED CHIMNEY

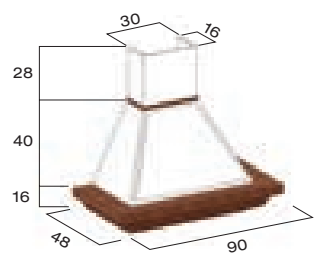
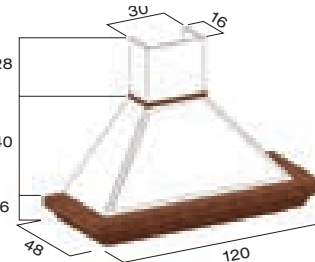
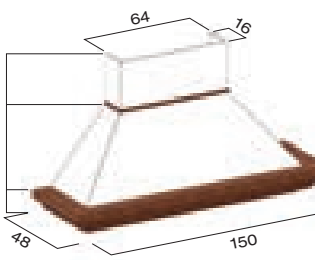
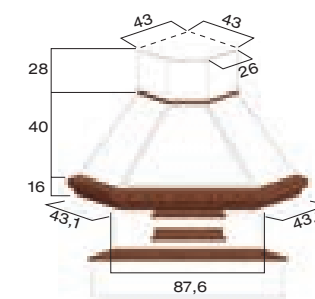
<p>DISPONIBILE ANCHE CON CAMINO NEI COLORI EFFETTO MURO PAG.59 ALSO AVAILABLE WITH CHIMNEY IN WALL EFFECT COLOURS PAGE 59</p>	<p>COD.</p>	<p>€ K80</p>					
<p>Cappa caminetto 90 H 84 prof.48 con cornice, gruppo ASPIRANTE portata 320 m³/h, fascione sagomato in tinta come anta impiallacciata 90 cm chimney hood H 84 depth 48 with cornice, EXTRACTOR UNIT air flow rate 320 m³/h, contoured band matching with the veneered door</p> 							
<p>Cappa caminetto 120 H 84 prof.48 con cornice, gruppo ASPIRANTE portata 320 m³/h, fascione sagomato in tinta come anta impiallacciata 120 cm chimney hood H 84 depth 48 with cornice, EXTRACTOR UNIT air flow rate 320 m³/h, contoured band matching with the veneered door</p> 	<p>camino bucciato bianco (opz.001) white textured chimney (opz.001)</p> <p>E3758590</p>	<p>844</p>					
<p>Cappa caminetto 150 H 84 prof.48 con cornice, gruppo ASPIRANTE portata 320 m³/h, fascione sagomato in tinta come anta impiallacciata 150 cm chimney hood H 84 depth 48 with cornice, EXTRACTOR UNIT air flow rate 320 m³/h, contoured band matching with the veneered door</p> 	<p>camino bucciato bianco (opz.001) white textured chimney (opz.001)</p> <p>E3758620</p>	<p>905</p>					
<p>Cappa caminetto ad angolo 105x105, gruppo ASPIRANTE portata 320 m³/h, fascione sagomato in tinta come anta impiallacciata (completa di pannelli c/nicchia per cucina ad angolo 110x110 e cornice) 105x105 corner chimney hood, EXTRACTOR UNIT air flow rate 320 m³/h, contoured band matching with the veneered door, (including panels with niche for corner kitchen 110x110 and cornice)</p> 	<p>camino bucciato bianco (opz.001) white textured chimney (opz.001)</p> <p>E3758610</p>	<p>1.068</p>					

CAPPE FASCIONE TIPO "SI" CAMINO BUCCIATO PER PIANO COTTURA AD INDUZIONE

HOOD BAND TYPE "SI" TEXTURED CHIMNEY FOR INDUCTION COOKER HOB

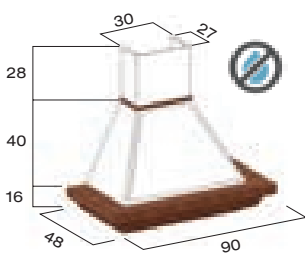
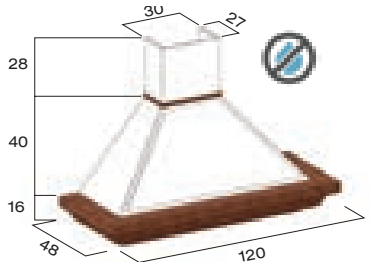
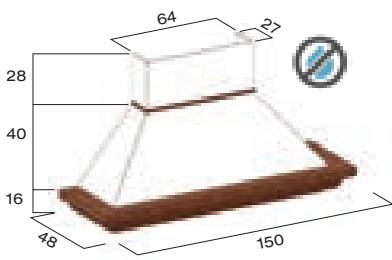
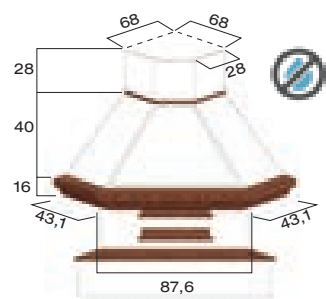
<p>DISPONIBILE ANCHE CON CAMINO NEI COLORI EFFETTO MURO PAG.59 ALSO AVAILABLE WITH CHIMNEY IN WALL EFFECT COLOURS PAGE 59</p>	COD.	€					
<p>Cappa caminetto 90 H 84 prof.48 con cornice, gruppo ASPIRANTE "NO DRIP" L 60 portata 600 m³/h, fascione sagomato in tinta come anta impiallacciata 90 cm chimney hood H 84 depth 48 with cornice, "NO DRIP" EXTRACTOR UNIT W 60 air flow rate 600 m³/h, contoured band matching with veneered door</p>  <p>camino bucciato bianco (opz.001) white textured chimney (opz.001)</p> <p>filtro carbone attivo active carbon filter</p>	E3758595	1.771					
<p>Cappa caminetto 120 H 84 prof.48 con cornice, gruppo ASPIRANTE "NO DRIP" L 90 portata 600 m³/h, fascione sagomato in tinta come anta impiallacciata 120 cm chimney hood H 84 depth 48 with cornice, "NO DRIP" EXTRACTOR UNIT W 90 air flow rate 600 m³/h, contoured band matching with veneered door</p>  <p>camino bucciato bianco (opz.001) white textured chimney (opz.001)</p> <p>filtro carbone attivo active carbon filter</p>	E3758625	1.808					
<p>Cappa caminetto 150 H 84 prof.48 con cornice, gruppo ASPIRANTE "NO DRIP" L 120 portata 600 m³/h, fascione sagomato in tinta come anta impiallacciata 150 cm chimney hood H 84 depth 48 with cornice, "NO DRIP" EXTRACTOR UNIT W 120 air flow rate 600 m³/h, contoured band matching with the veneered door</p>  <p>camino bucciato bianco (opz.001) white textured chimney (opz.001)</p> <p>filtro carbone attivo active carbon filter</p>	E3758655	1.865					
<p>Cappa caminetto ad angolo 105x105, gruppo ASPIRANTE "NO DRIP" L 90 portata 600 m³/h, fascione sagomato in tinta come anta impiallacciata (completa di pannelli c/nicchia per cucina ad angolo 110x110 e cornice) 105x105 corner chimney hood, "NO DRIP" EXTRACTOR UNIT W 90 air flow rate 600 m³/h, contoured band matching with veneered door (including panels with niche for corner kitchen 110x110 and cornice)</p>  <p>camino bucciato bianco (opz.001) white textured chimney (opz.001)</p> <p>filtro carbone attivo active carbon filter</p>	E3758615	1.978					

CAPPE FASCIONE TIPO "S2" CAMINO BUCCIATO

HOOD BAND TYPE "S2" TEXTURED CHIMNEY

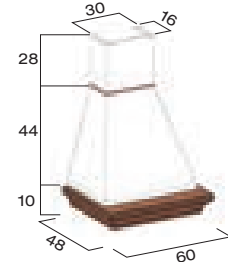
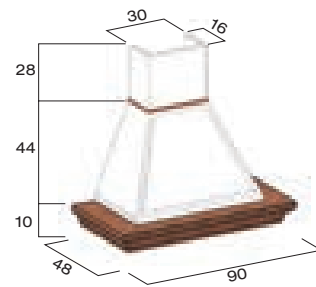
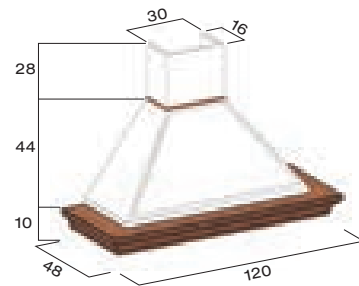
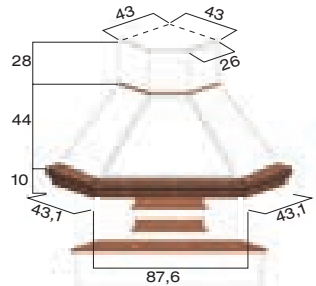
<p>DISPONIBILE ANCHE CON CAMINO NEI COLORI EFFETTO MURO PAG.59 ALSO AVAILABLE WITH CHIMNEY IN WALL EFFECT COLOURS PAGE 59</p>	<p>COD.</p>	<p>€ K80</p>					
<p>Cappa caminetto 60 H 82 prof.48 con cornice, gruppo ASPIRANTE portata 320 m³/h, fascione sagomato "S2" in tinta come anta impiallacciata 60 cm chimney hood H 82 depth 48 with cornice, EXTRACTOR UNIT air flow rate 320 m³/h, contoured band "S2" matching with veneered door</p> 							
<p>Cappa caminetto 90 H 82 prof.48 con cornice, gruppo ASPIRANTE portata 320 m³/h, fascione sagomato "S2" in tinta come anta impiallacciata 90 cm chimney hood H 82 depth 48 with cornice, EXTRACTOR UNIT air flow rate 320 m³/h, contoured band "S2" matching with veneered door</p> 							
<p>Cappa caminetto 120 H 82 prof.48 con cornice, gruppo ASPIRANTE portata 320 m³/h, fascione sagomato "S2" in tinta come anta impiallacciata 120 cm chimney hood H 82 depth 48 with cornice, EXTRACTOR UNIT air flow rate 320 m³/h, contoured band "S2" matching with veneered door</p> 							
<p>Cappa caminetto ad angolo 105x105, gruppo ASPIRANTE portata 320 m³/h, fascione sagomato "S2" in tinta come anta impiallacciata (completa di pannelli c/nicchia per cucina ad angolo 110x110 e cornice) 105x105 corner chimney hood, EXTRACTOR UNIT air flow rate 320 m³/h, contoured band "S2" matching with veneered door (including panels with niche for corner kitchen 110x110 and cornice)</p> 							

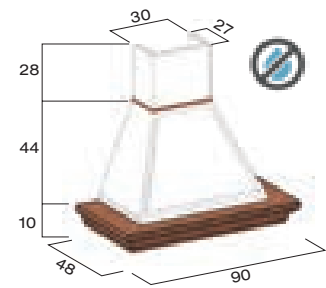

CAPPE FASCIONE TIPO "S2I" CAMINO BUCCIATO PER PIANO COTTURA AD INDUZIONE

HOOD BAND TYPE "S2I" TEXTURED CHIMNEY FOR INDUCTION COOKER HOB

<p>DISPONIBILE ANCHE CON CAMINO NEI COLORI EFFETTO MURO PAG.59 ALSO AVAILABLE WITH CHIMNEY IN WALL EFFECT COLOURS PAGE 59</p>	COD.	€					
<p>Cappa caminetto 90 H 82 prof.48 con cornice, gruppo ASPIRANTE "NO DRIP" L 60 portata 600 m³/h, fascione sagomato "S2I" in tinta come anta impiallacciata 90 cm chimney hood H 82 depth 48 with cornice, "NO DRIP" EXTRACTOR UNIT W 60 air flow rate 600 m³/h, contoured band "S2I" matching with veneered door</p> 		K80					

CAPPE FASCIONE TIPO "E" CAMINO BUCCIATO

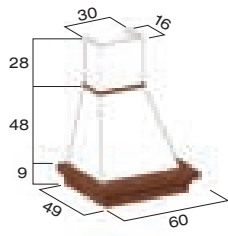
HOOD BAND TYPE "E" TEXTURED CHIMNEY

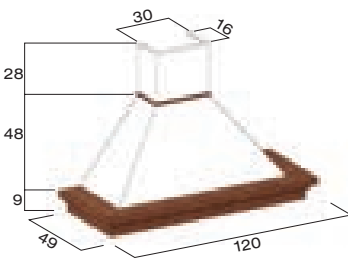
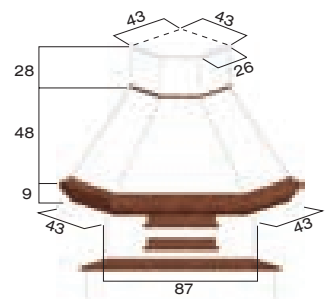
	COD.	€ K80				
<p>Cappa caminetto 60 H 85 prof.49 con cornice, gruppo ASPIRANTE portata 320 m³/h, fascione in tinta come anta impiallacciata 60 cm chimney hood H 85 depth 49 with cornice, EXTRACTOR UNIT air flow rate 320 m³/h, band matching with veneered door</p> 						
<p>camino bucciato bianco (opz.001) white textured chimney (opz.001)</p>	E3970600	668				
<p>Cappa caminetto 90 H 85 prof.49 con cornice, gruppo ASPIRANTE portata 320 m³/h, fascione in tinta come anta impiallacciata 90 cm chimney hood H 85 depth 49 with cornice, EXTRACTOR UNIT air flow rate 320 m³/h, band matching with veneered door</p> 						
<p>camino bucciato bianco (opz.001) white textured chimney (opz.001)</p>	E3970900	690				
<p>Cappa caminetto 120 H 85 prof.49 con cornice, gruppo ASPIRANTE portata 320 m³/h, fascione in tinta come anta impiallacciata 120 cm chimney hood H 85 depth 49 with cornice, EXTRACTOR UNIT air flow rate 320 m³/h, band matching with veneered door</p> 						
<p>camino bucciato bianco (opz.001) white textured chimney (opz.001)</p>	E3971200	750				
<p>Cappa caminetto ad angolo 105x105, gruppo ASPIRANTE portata 320 m³/h, fascione in tinta come anta impiallacciata (completa di pannelli c/nicchia per cucina ad angolo 110x110 e cornice) 105x105 corner chimney hood, EXTRACTOR UNIT air flow rate 320 m³/h, band matching with veneered door (including panels with niche for corner kitchen 110x110 and cornice)</p> 						
<p>camino bucciato bianco (opz.001) white textured chimney (opz.001)</p>	E3972110	891				

CAPPE FASCIONE TIPO "EI" CAMINO BUCCIATO PER PIANO COTTURA AD INDUZIONE

HOOD BAND TYPE "EI" TEXTURED CHIMNEY FOR INDUCTION COOKER HOB

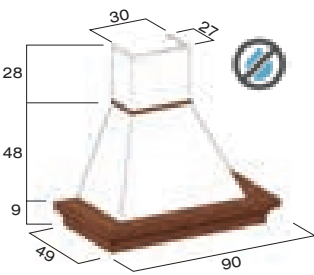
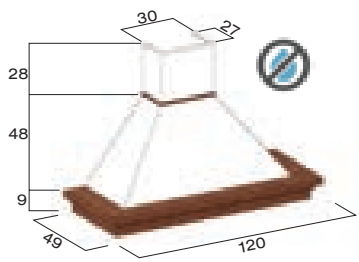
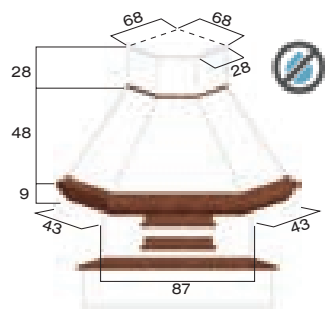
	COD.	€ K80				
<p>Cappa caminetto 90 H 85 prof.49 con cornice, gruppo ASPIRANTE "NO DRIP" L 60 portata 600 m³/h, fascione in tinta come anta impiallacciata 90 cm chimney hood H 85 depth 49 with cornice, "NO DRIP" EXTRACTOR UNIT W 60 air flow rate 600 m³/h, band matching with veneered door</p> 						
<p>camino bucciato bianco (opz.001) white textured chimney (opz.001)</p>	E3970905	1.528				
<p>filtro carbone attivo active carbon filter</p>	08750844R	+42				
<p>Cappa caminetto 120 H 85 prof.49 con cornice, gruppo ASPIRANTE "NO DRIP" L 90 portata 600 m³/h, fascione in tinta come anta impiallacciata 120 cm chimney hood H 85 depth 49 with cornice, "NO DRIP" EXTRACTOR UNIT W 90 air flow rate 600 m³/h, band matching with veneered door</p> 						
<p>camino bucciato bianco (opz.001) white textured chimney (opz.001)</p>	E3971205	1.575				
<p>filtro carbone attivo active carbon filter</p>	08750844R	+42				
<p>Cappa caminetto ad angolo 105x105, gruppo ASPIRANTE "NO DRIP" L 90 portata 600 m³/h, fascione in tinta come anta impiallacciata (completa di pannelli c/nicchia per cucina ad angolo 110x110 e cornice) 105x105 corner chimney hood, "NO DRIP" EXTRACTOR UNIT W 90 air flow rate 600 m³/h, band matching with veneered door (including panels with niche for corner kitchen 110x110 and cornice)</p> 						
<p>camino bucciato bianco (opz.001) white textured chimney (opz.001)</p>	E3972115	1.736				
<p>filtro carbone attivo active carbon filter</p>	08750844R	+42				

CAPPE FASCIONE TIPO "SN" CAMINO BUCCIATO

HOOD BAND TYPE "SN" TEXTURED CHIMNEY

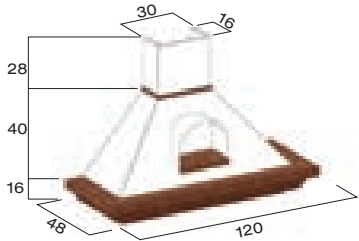
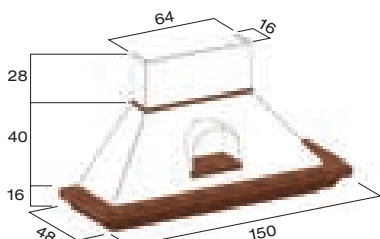
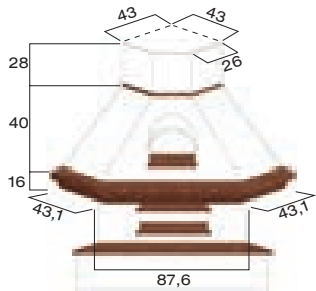
<p>DISPONIBILE ANCHE CON CAMINO NEI COLORI EFFETTO MURO PAG.59 ALSO AVAILABLE WITH CHIMNEY IN WALL EFFECT COLOURS PAGE 59</p>	<p>COD.</p>	<p>€ K80</p>					
<p>Cappa caminetto 90 H 84 prof.48 con cornice e camino con nicchia, gruppo ASPIRANTE portata 320 m³/h, fascione sagomato in tinta come anta 90 cm chimney hood H 84 depth 48 with cornice and chimney with niche, EXTRACTOR UNIT air flow rate 320 m³/h, contoured band matching with the door</p> 							
	<p>camino bucciato bianco (opz.001) white textured chimney (opz.001)</p>	<p>E3758090</p>	<p>914</p>				
<p>Cappa caminetto 120 H 84 prof.48 con cornice e camino con nicchia, gruppo ASPIRANTE portata 320 m³/h, fascione sagomato in tinta come anta 120 cm chimney hood H 84 depth 48 with cornice and chimney with niche, EXTRACTOR UNIT air flow rate 320 m³/h, contoured band matching with the door</p> 							
	<p>camino bucciato bianco (opz.001) white textured chimney (opz.001)</p>	<p>E3758120</p>	<p>974</p>				
<p>Cappa caminetto 150 H 84 prof.48 con cornice e camino con nicchia, gruppo ASPIRANTE portata 320 m³/h, fascione sagomato in tinta come anta 150 cm chimney hood H 84 depth 48 with cornice and chimney with niche, EXTRACTOR UNIT air flow rate 320 m³/h, contoured band matching with the door</p> 							
	<p>camino bucciato bianco (opz.001) white textured chimney (opz.001)</p>	<p>E3758150</p>	<p>1.031</p>				
<p>Cappa caminetto ad angolo 105x105 e camino con nicchia, gruppo ASPIRANTE portata 320 m³/h, fascione sag.in tinta come anta (completa di pannelli c/nicchia per cucina ad angolo 110x110 e cornice) 105x105 corner chimney hood and chimney with niche, EXTRACTOR UNIT air flow rate 320 m³/h, contoured band matching with the door (including panels with niche for corner kitchen 110x110 and cornice)</p> 							
	<p>camino bucciato bianco (opz.001) white textured chimney (opz.001)</p>	<p>E3758110</p>	<p>1.125</p>				

CAPPE ISOLA CAMINO BUCCIATO

ISLAND HOOD TEXTURED CHIMNEY

DISPONIBILE ANCHE CON CAMINO NEI COLORI EFFETTO MURO
ALSO AVAILABLE WITH CHIMNEY IN WALL EFFECT COLOURS

COD.

€
K80

Cappa isola con fascione in tinta come anta
gruppo ASPIRANTE portata 320 m³/h

Island hood with band matching with the door
EXTRACTOR UNIT air flow rate 320 m³/h

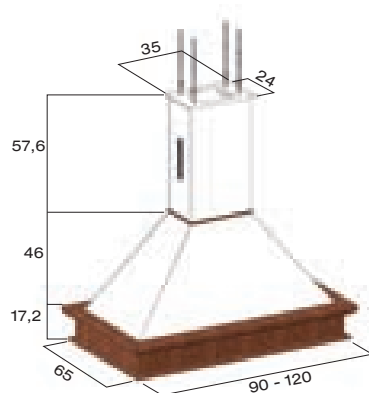

L 90

E3752129

966

L 120

E3752130

1.064

camino bucciato bianco (opz.001)
white textured chimney (opz.001)

COLORI EFFETTO MURO PER CAMINI CAPPE

WALL EFFECT COLOURS FOR CHIMNEY HOODS



BIANCO ASSOLUTO
a rullo (opz.R005)
frattonato (opz.F005)

ABSOLUTE WHITE
for roller (opt.R005)
for trowel (opt.F005)



CIPRIA
a rullo (opz.R114)
frattonato (opz.F114)

PALE PINK
for roller (opt.R114)
for trowel (opt.F114)



PANNA
a rullo (opz.R012)
frattonato (opz.F012)

CREAM
for roller (opt.R012)
for trowel (opt.F012)



CORDA
a rullo (opz.R125)
frattonato (opz.F125)

JUTE
for roller (opt.R125)
for trowel (opt.F125)



GRIGIO TRAFFICO
a rullo (opz.R260)
frattonato (opz.F260)

TRAFFIC GREY
for roller (opt.R260)
for trowel (opt.F260)

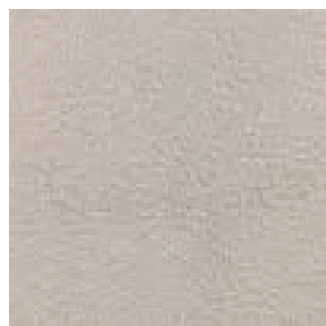

GRIGIO PERLA
a rullo (opz.R255)
frattonato (opz.F255)

PEARL GREY
for roller (opt.R255)
for trowel (opt.F255)





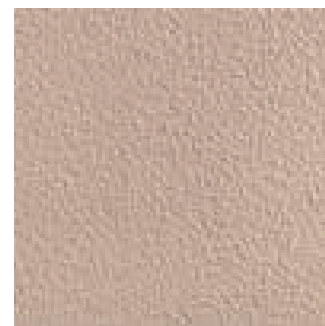

GIALLO CHIARO
a rullo (opz.R023)
frattonato (opz.F023)



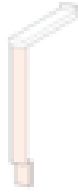

LIGHT YELLOW
for roller (opt.R023)
for trowel (opt.F023)



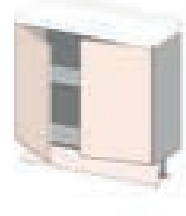



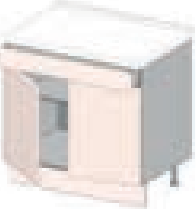

CUOIO
a rullo (opz.R250)
frattonato (opz.F250)

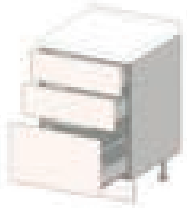

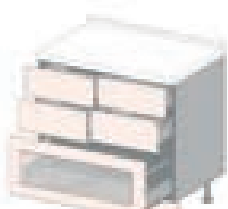

LEATHER
for roller (opt.R250)
for trowel (opt.F250)

LE BASI NON SONO COMPRENSIVE DI TOP THE BASE UNITS DO NOT INCLUDE THE TOPS		COD.	FASCIA A K80	FASCIA B K80				
 <p>fascia tamponamento filler panel</p>	<p>L da 3 a 10 size from 3 to 10</p>	E4800000	105	139				
 <p>jolly base L da 10 a 30 jolly base unit size from 10 to 30</p>	<p>in nobilitato melamine coated impiallacciato veneered</p>	E4700000	128	128				
		E4710000	328	328				
 <p>1 anta 1 door</p>	<p>L 15 L 30 L 40 L 45 L 60 L 65 L 75</p>	E4010151/2	164	198				
		E4010301/2	184	227				
		E4010401/2	204	253				
		E4010451/2	211	261				
		E4010601/2	246	307				
		E4010651/2	256	320				
		E4010751/2	297	367				
 <p>2 ante 2 doors</p>	<p>L 60 L 80 L 90 L 120</p>	E4010600	311	397				
		E4010800	351	449				
		E4010900	367	467				
		E4011200	446	569				
 <p>1 anta 1 door</p>	<p>P 34,5 L 30 L 40 L 45 L 60 L 65 L 75</p>	E4017301/2	164	207				
		E4017401/2	182	232				
		E4017451/2	184	234				
		E4017601/2	214	275				
		E4017651/2	226	290				
		E4017751/2	255	326				
 <p>2 ante 2 doors</p>	<p>P 34,5 L 60 L 80 L 90 L 120</p>	E4017600	282	368				
		E4017800	317	415				
		E4017900	326	426				
		E4018200	446	569				

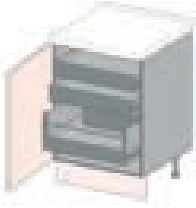
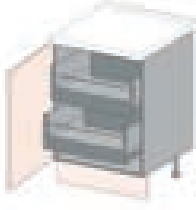
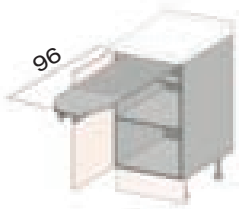
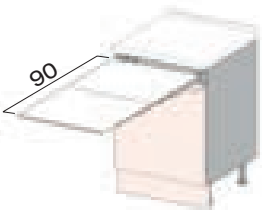
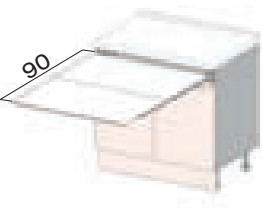
LE BASI NON SONO COMPRENSIVE DI TOP THE BASE UNITS DO NOT INCLUDE THE TOPS		COD.	FASCIA A K80	FASCIA B K80			
 <p>1 anta vetro 2 ripiani vetro 1 glass door 2 glass shelves</p>	L 45	E4014451/2	333	410			
	L 60	E4014601/2	393	484			
 <p>cestello estraibile chiusura soft pull-out basket unit soft-closing system</p>	L 15	E4150150	195	229			
	L 30	E4150300	254	297			
	L 45	E4150450	283	333			
 <p>1 cassetto H 12 1 anta H 60 1 drawer H 12 1 door H 60</p>	L 45	E4021451/2	294	356			
	L 60	E4021601/2	332	404			
 <p>1 cassetto H 12 2 ante H 60 1 drawer H 12 2 doors H 60</p>	L 90	E4021900	468	586			
 <p>4 cassetti H 18 4 drawers H 18</p>	L 30	E4101300	397	448			
	L 40	E4101400	417	476			
	L 45	E4101450	430	493			
	L 60	E4101600	479	551			
 <p>portaposate in plastica per cassetti plastic cutlery tray for drawers</p>	L 30	08700030X	10	10			
	L 40	08700040X	10	10			
	L 45	08700050X	10	10			
	L 60	08700060X	11	11			
	divisori regolabili L 90 adjustable separators	L 90	08700070X	32	32		

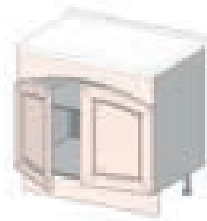
LE BASI NON SONO COMPRENSIVE DI TOP THE BASE UNITS DO NOT INCLUDE THE TOPS		COD.	FASCIA A K80	FASCIA B K80				
 <p>2 cassetti H 18 1 cestone H 36 2 drawers H 18 1 deep drawer H 36</p>	L 45	E4131450	398	467				
	L 60	E4131600	443	522				
	L 90	E4131900	533	639				
 <p>2 cassetti H 18 1 cestone vetro H 36 2 drawers H 18 1 glass deep drawer H 36</p>	L 45	E4141450	450	537				
	L 60	E4141600	502	602				
	L 90	E4141900	608	740				
 <p>4 cassetti H 18 1 cestone H 36 4 drawers H 18 1 deep drawer H 36</p>	L 90	E4300900	730	845				
 <p>4 cassetti H 18 1 cestone vetro H 36 4 drawers H 18 1 glass deep drawer H 36</p>	L 90	E4301900	805	946				
 <p>2 cestoni H 36 2 deep drawers H 36</p>	L 45	E4171450	365	440				
	L 60	E4171600	406	491				
	L 90	E4171900	481	587				
 <p>2 cestoni 1 frontale chiuso H 36 1 frontale vetro H 36 2 deep drawers 1 full front H 36 1 glass front H 36</p>	L 45	E4181450	416	510				
	L 60	E4181600	465	571				
	L 90	E4181900	555	687				

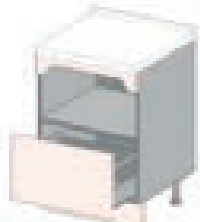
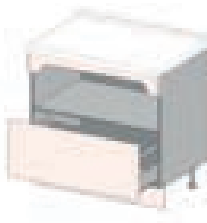
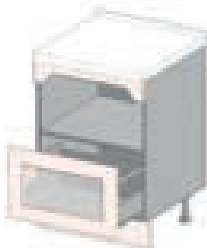
LE BASI NON SONO COMPRENSIVE DI TOP THE BASE UNITS DO NOT INCLUDE THE TOPS		COD.	FASCIA A K80	FASCIA B K80			
 <p>2 cestoni vetro H 36 2 glass deep drawers H 36</p>	L 45	E4191450	468	579			
	L 60	E4191600	524	651			
	L 90	E4191900	630	788			
 <p>1 anta 2 cassetti interni 1 cestone interno posizionare a 5 cm dalla parete laterale 1 door 2 internal drawers 1 internal deep drawer place at 5 cm from the side wall</p>	L 45	E4236461/2	468	518			
	L 60	E4236611/2	481	543			
 <p>1 anta 2 cestoni interni posizionare a 5 cm dalla parete laterale 1 door 2 internal deep drawers place at 5 cm from the side wall</p>	L 45	E4236471/2	378	428			
	L 60	E4236621/2	426	487			
 <p>base asse da stiro estraibile 1 anta H 72 base unit with pull-out ironing board 1 door H 72</p>	L 45	E4220451/2	815	872			
 <p>base tavolo estraibile LUNCH portata 60 kg 1 frontale H 12 1 anta H 60 base unit with pull-out table LUNCH load capacity kg 60 1 front H 12 1 door H 60</p>	L 60	E4232601/2	814	878			
 <p>base tavolo estraibile LUNCH portata 60 kg 1 frontale H 12 2 ante H 60 base unit with pull-out table LUNCH load capacity kg 60 1 front H 12 2 doors H 60</p>	L 90	E4232900	980	1.082			

LE BASI NON SONO COMPRENSIVE DI TOP THE BASE UNITS DO NOT INCLUDE THE TOPS		COD.	FASCIA A K80	FASCIA B K80				
 <p>base 2 ante e fascia sagomate base unit 2 doors and band shaped</p>	L 90	E4050900	530	726				
	L 120	E4051200	597	816				
 <p>terminale a giorno tipo "C" open end base unit type "C"</p>	L 34,5							
	in nobilitato melamine coated	E4620311/2	132	132				
	impiallacciato veneered	E4621311/2	351	351				
 <p>base vano a giorno con cornice sagomata 1 cestone H 36 base unit with open compartment and contoured frame 1 deep drawer H 36</p>	L 60 P 34,5	E4343600	302	371				
	L 60 P 61	E4341600	321	390				
	mag.vano a giorno impiallacciato surcharge veneered open unit		+312	+312				
 <p>base vano a giorno con cornice sagomata 1 cestone H 36 base unit with open compartment and contoured frame 1 deep drawer H 36</p>	L 90 P 34,5	E4343900	373	458				
	L 90 P 61	E4341900	383	467				
	mag.vano a giorno impiallacciato surcharge veneered open unit		+312	+312				
 <p>base vano a giorno con cornice sagomata 1 cestone vetro H 36 base unit with open compartment and contoured frame 1 glass deep drawer H 36</p>	L 60 P 34,5	E4344600	359	449				
	L 60 P 61	E4342600	378	468				
	mag.vano a giorno impiallacciato surcharge veneered open unit		+312	+312				
 <p>base vano a giorno con cornice sagomata 1 cestone vetro H 36 base unit with open compartment and contoured frame 1 glass deep drawer H 36</p>	L 90 P 34,5	E4344900	446	557				
	L 90 P 61	E4342900	456	566				
	mag.vano a giorno impiallacciato surcharge veneered open unit		+312	+312				

BASI ANGOLO

CORNER BASE UNITS

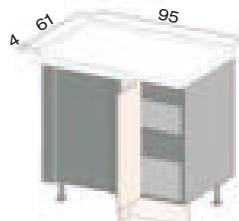
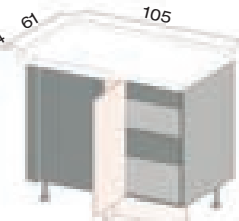
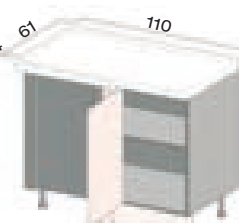
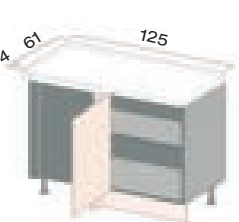
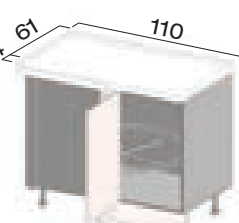
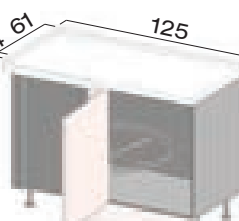

H 85 P 65

LE BASI NON SONO COMPRENSIVE DI TOP THE BASE UNITS DO NOT INCLUDE THE TOPS		COD.	FASCIA A K80	FASCIA B K80			
 <p>angolo L 95 1 ripiano 1 anta L 30 cassone 90 corner unit W 95 1 shelf 1 door W 30 structure 90</p> <p>verso dx RH version</p>	95x65	E4400951/2	352	423			
 <p>angolo L 105 1 ripiano 1 anta L 40 cassone 90 corner unit W 105 1 shelf 1 door W 40 structure 90</p> <p>verso dx RH version</p>	105x65	E4401041/2	362	439			
 <p>angolo L 110 1 ripiano 1 anta L 45 cassone 105 corner unit W 110 1 shelf 1 door W 45 structure 105</p> <p>verso dx RH version</p>	110x65	E4401091/2	377	455			
 <p>angolo L 125 1 ripiano 1 anta L 60 cassone 120 con tirante corner unit W 125 1 shelf 1 door W 60 structure 120 with tie beam</p> <p>verso dx RH version</p>	125x65	E4401241/2	425	515			
 <p>angolo L 110 cestello mezzaluna orion grau 1 anta L 45 cassone 105 corner unit W 110 crescent-shaped orion grau wire basket unit 1 door W 45 structure 105</p> <p>verso dx RH version</p>							
	1 cestello 110x65 1 basket drawer	E4401101/2	390	468			
	2 cestelli 110x65 2 basket drawers	E4401111/2	426	504			
 <p>angolo L 125 cestello mezzaluna orion grau 1 anta L 60 cassone 120 corner unit W 125 crescent-shaped orion grau wire basket units 1 door W 60 structure 120</p> <p>verso dx RH version</p>							
	1 cestello 125x65 1 basket drawer	E4401251/2	421	511			
	2 cestelli 125x65 2 basket drawers	E4401261/2	457	547			

BASI ANGOLO

CORNER BASE UNITS

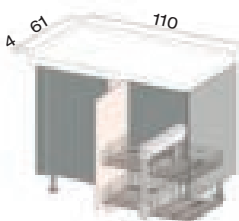

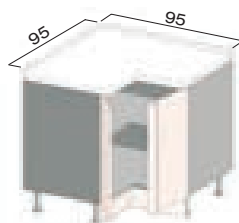
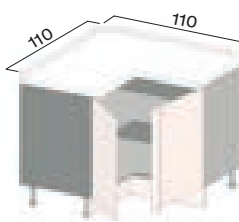
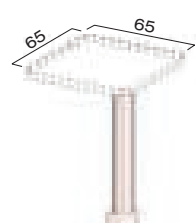
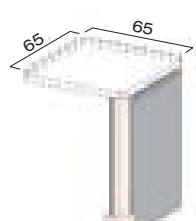
H 85 P 65

LE BASI NON SONO COMPRENSIVE DI TOP THE BASE UNITS DO NOT INCLUDE THE TOPS		COD.	FASCIA A K80	FASCIA B K80				
 <p>angolo L 110 4 cestelli orion grau estraibili indipendenti dall'anta 1 anta L 45 cassone 105 corner unit W 110 4 pull-out orion grau basket units opening independently from door 1 door W 45 structure 105</p> <p>verso dx RH version</p>	110x65	E4451101/2	866	944				
	 <p>angolo L 125 4 cestelli orion grau estraibili indipendenti dall'anta 1 anta L 60 cassone 120 corner unit W 125 4 pull-out orion grau basket units opening independently from door 1 door W 60 structure 120</p> <p>verso dx RH version</p>	125x65	E4451251/2	933	1.022			
 <p>angolo 95x95 1 ripiano - 2 ante L 30 angolare unito all'anta dx corner unit 95x95 1 shelf - 2 doors W 30 angular filler attached to the RH door</p>	95x95	E4481950	667	780				
	 <p>angolo 110x110 1 ripiano - 2 ante L 45 angolare unito all'anta dx corner unit 110x110 1 shelf - 2 doors W 45 angular filler attached to the RH door</p>	110x110	E4482100	726	854			
 <p>angolo 65x65 con supporto N.B.: solo angolare corner unit 65x65 with support Note: only angular filler</p>	65x65	E4480650	99	128				
	 <p>angolo 65x65 con supporto per inserimento lavastoviglie destra o sinistra N.B.: solo angolare con fianco corner unit 65x65 with support for dishwasher placed on the right or the left side Note: only angular filler with side</p> <p>verso dx RH version</p>	65x65	E4480651/2	139	170			

BASI ANGOLO PANNELLO COME ANTA

H 85 P 61

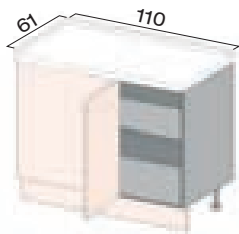
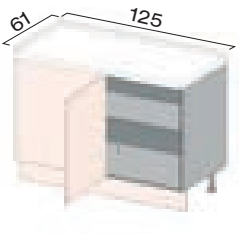
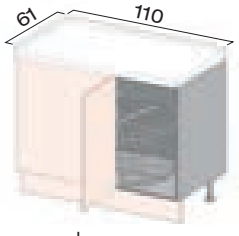
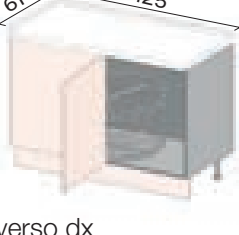



CORNER BASE UNITS PANEL AS DOOR

LE BASI NON SONO COMPRENSIVE DI TOP THE BASE UNITS DO NOT INCLUDE THE TOPS		COD.	FASCIA A K80	FASCIA B K80			
 <p>angolo L 110 1 ripiano 1 anta L 45 pannello liscio come anta cassone 110 corner unit W 110 1 shelf 1 door W 45 panel without frame same as door structure 110</p> <p>verso dx RH version</p>	110x61	E4403091/2	432	482			
 <p>angolo L 125 1 ripiano 1 anta L 60 pannello liscio come anta cassone 125 con tirante corner unit W 125 1 shelf 1 door W 60 panel without frame same as door structure 125 with tie beam</p> <p>verso dx RH version</p>	125x61	E4403241/2	483	544			
 <p>angolo L 110 2 cestelli mezzaluna orion grau 1 anta L 45 pannello liscio come anta cassone 110 corner unit W 110 2 crescent-shaped orion grau wire basket units 1 door W 45 panel without frame same as door structure 110</p> <p>verso dx RH version</p>	110x61	E4403111/2	469	519			
 <p>angolo L 125 2 cestelli mezzaluna orion grau 1 anta L 60 pannello liscio come anta cassone 125 corner unit W 125 2 crescent-shaped orion grau wire basket units 1 door W 60 panel without frame same as door structure 125</p> <p>verso dx RH version</p>	125x61	E4403261/2	504	565			
 <p>angolo L 110 4 cestelli orion grau estraibili indipendenti dall'anta 1 anta L 45 pannello liscio come anta cassone 110 corner unit W 110 4 pull-out orion grau basket units opening independently from door 1 door W 45 panel without frame same as door structure 110</p> <p>verso dx RH version</p>	110x61	E4453101/2	909	959			
 <p>angolo L 125 4 cestelli orion grau estraibili indipendenti dall'anta 1 anta L 60 pannello liscio come anta cassone 125 corner unit W 125 4 pull-out orion grau basket units opening independently from door 1 door W 60 panel without frame same as door structure 125</p> <p>verso dx RH version</p>	125x61	E4453251/2	979	1.040			

BASI PER FORNI

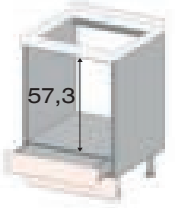
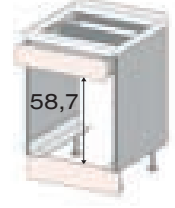
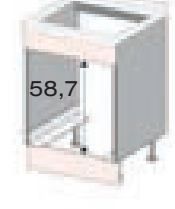
OVEN BASE UNITS

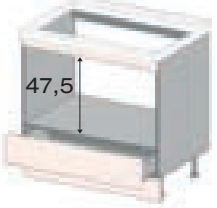
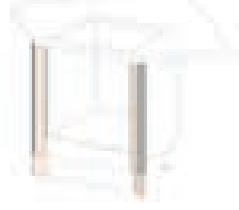
H 85 P 61



LE BASI NON SONO COMPRENSIVE DI TOP THE BASE UNITS DO NOT INCLUDE THE TOPS		COD.	FASCIA A K80	FASCIA B K80				
 <p>base per forno elettrico H 60 cassetto H 12 inferiore electric oven base unit H 60 lower drawer H 12</p>	L 60	E5510607	215	232				
 <p>base per forno elettrico H 60 cassetto H 12 superiore electric oven base unit H 60 upper drawer H 12</p>	L 60	E5510608	215	232				
 <p>base per forno elettrico H 60 frontale superiore fisso H 12 N.B.: da utilizzare per top H 2 e per P.C. filo top electric oven base unit H 60 fixed upper front H 12 Note: to be used in conjunction with tops H 2 and flush hobs</p>	L 60	E5510620	147	165				
 <p>base per maxiforno H 60 cassetto H 12 maxi-oven base unit H 60 drawer H 12</p>	L 90	E5510907	263	288				
 <p>base per maxiforno H 48 fascia superiore H 5,9 cassetto H 18 maxi-oven base unit H 48 strip above H 5,9 drawer H 18</p>	L 90	E5510920	294	337				
 <p>kit raccordo base angolo junction kit for corner base unit</p>	110x110	E5471100	135	165				
 <p>kit raccordo base angolo per inserimento lavastoviglie a destra o sinistra junction kit for corner base unit for dishwasher placed on the right or the left side</p> <p>verso dx RH version</p>	110x110	E5471151/2	173	202				

BASI PER PIANI COTTURA

H 85 P 61

COOKER HOB BASE UNITS

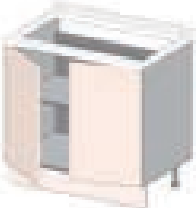
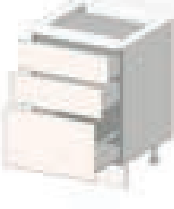
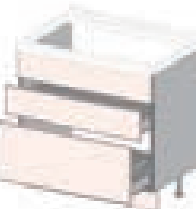
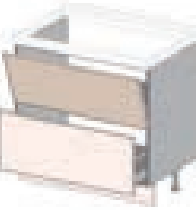

LE BASI NON SONO COMPRENSIVE DI TOP
THE BASE UNITS DO NOT INCLUDE THE TOPS

	COD.	FASCIA A K80	FASCIA B K80				
 <p>base predisposta piano cottura 1 anta base unit configured for cooker hob 1 door</p>	L 60	E5500601/2	250	311			
		opz.101	+55	+55			
			mag.base piano cottura ad induzione surcharge base unit for induction cooker hob				
 <p>base predisposta piano cottura 2 ante base unit configured for cooker hob 2 doors</p>	L 90	E5500900	371	472			
		opz.101	+55	+55			
			mag.base piano cottura ad induzione surcharge base unit for induction cooker hob				
 <p>Maggiorazione per base predisposta piano cottura ad induzione con lamierino di protezione N.B.: realizzabile su base 2 cassetti+1 cestone, base 2 cestoni e base 4 cassetti Surcharge for base unit configured for induction cooker hob with protection metal sheet Note: available on base unit 2 drawers+1 deep drawer, base unit 2 deep drawers and base unit 4 drawers</p>		opz.101	+55	+55			
 <p>base predisposta piano cottura con cappa integrata 1 frontale superiore fisso H 18 1 cassetto H 18 P 40 1 cestone H 36 P 40 base unit configured for cooker hob with integrated hood 1 fixed upper front H 18 1 drawer H 18 D 40 1 deep drawer H 36 D 40</p>	L 90	E5509090	481	586			
 <p>base predisposta piano cottura con cappa integrata 1 anta vasistas H 36 1 cestone H 36 P 40 base unit configured for cooker hob with integrated hood 1 flap door H 36 1 deep drawer H 36 D 40</p>	L 90	E5509095	573	679			
 <p>Esempio di piano cottura con cappa integrata Example of cooker hob with integrated hood</p>							

SOTTOLAVELLI

SINK BASE UNITS

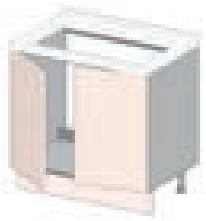
H 85 P 61

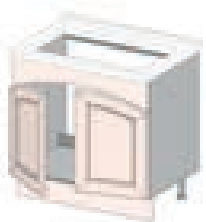
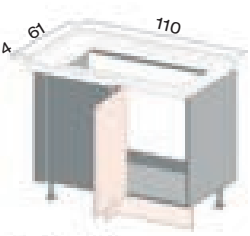
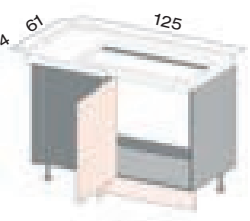

LE BASI NON SONO COMPRENSIVE DI TOP THE BASE UNITS DO NOT INCLUDE THE TOPS		COD.	FASCIA A K80	FASCIA B K80				
 <p>sottolavello 1 anta sink base unit 1 door</p>	L 45	E5010451/2	212	262				
	L 60	E5010601/2	245	307				
	L 75	E5010751/2	285	355				
 <p>sottolavello 2 ante sink base unit 2 doors</p>	L 60	E5010600	309	395				
	L 80	E5010800	347	445				
	L 90	E5010900	357	457				
	L 120	E5011200	425	548				
 <p>sottolavello 2 cestoni H 36 cestone superiore sagomato con vaschette sink base unit 2 deep drawers H 36 contoured upper deep drawer with trays</p>	L 60	E5200600	440	526				
	L 90	E5200900	511	617				
 <p>sottolavello 2 ante e fascia sagomata sink base unit 2 doors and band shaped</p>	L 90	E5030900	537	733				
	L 120	E5031200	606	824				
 <p>sottolavello angolo L 110 1 anta L 45 cassone 105 corner sink base unit W 110 1 door W 45 structure 105</p> <p>verso dx RH version</p>	110x65	E4421101/2	360	438				
 <p>sottolavello angolo L 125 1 anta L 60 cassone 120 corner sink base unit W 125 1 door W 60 structure 120</p> <p>verso dx RH version</p>	125x65	E4421251/2	391	481				

SOTTOLAVELLI

SINK BASE UNITS

H 85 P 61

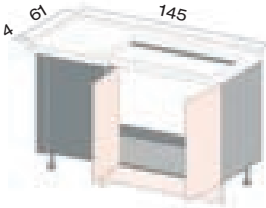
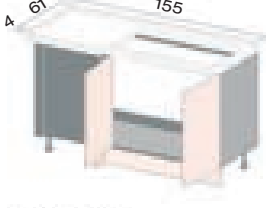
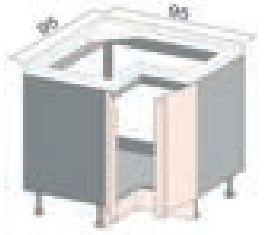





LE BASI NON SONO COMPRENSIVE DI TOP
THE BASE UNITS DO NOT INCLUDE THE TOPS

	COD.	FASCIA A K80	FASCIA B K80			
 <p>sottolavello angolo L 145 2 ante L 40 cassone 140 corner sink base unit W 145 2 doors W 40 structure 140</p> <p>verso dx RH version</p>	145x65	E4421451/2	496	622		
 <p>sottolavello angolo L 155 2 ante L 45 cassone 150 corner sink base unit W 155 2 doors W 45 structure 150</p> <p>verso dx RH version</p>	155x65	E4421551/2	507	636		
 <p>sottolavello angolo 95x95 2 ante L 30 con angolare corner sink base unit 95x95 2 doors W 30 with angular</p>	95x95	E5021950	682	796		
 <p>sottolavello angolo 110x110 2 ante L 45 con angolare corner sink base unit 110x110 2 doors W 45 with angular</p>	110x110	E5022100	751	879		

BASI PER ELETTRODOMESTICI SOTTOTOP

H 85 P 61

BASE UNITS FOR UNDER-TOP APPLIANCES



LE BASI NON SONO COMPRENSIVE DI TOP THE BASE UNITS DO NOT INCLUDE THE TOPS		COD.	FASCIA A K80	FASCIA B K80				
 <p>anta per lavastoviglie scomparsa totale completa di kit protezione fianchi door for fully integrated dishwasher with protection kit for side panels</p>	L 45	E4490080	126	180				
	L 60	E4490090	156	222				
 <p>anta per lavastoviglie scomparsa totale L 75 completa di kit protezione fianchi N.B.: composta da lavastoviglie L 60 + jolly base L 15 door for fully integrated dishwasher W 75 with protection kit for side panels Note: realized with dishwasher W 60 + jolly base unit W 15</p> <p>verso sx LH version</p>	L 75	E4490131/2	304	380				
 <p>anta per lavastoviglie scomparsa totale estetica 2 cestoni completa di kit protezione fianchi door for fully integrated dishwasher 2 deep drawers aesthetic with protection kit for side panels</p>	L 60	E4490100	222	315				
 <p>anta per lavastoviglie comandi a vista completa di kit protezione fianchi door for dishwasher with visible controls with protection kit for side panels</p>	L 45	E4490050	107	158				
	L 60	E4490060	124	184				
 <p>kit protezione fianchi per lavastoviglie protection kit for side panels for dishwasher</p> 								
 <p>anta per lavabiancheria scomparsa totale door for fully integrated washing machine</p>	L 60	E4490011/2	156	222				

BASI PER ELETTRODOMESTICI SOTTOTOP

H 85 P 61

BASE UNITS FOR UNDER-TOP APPLIANCES



LE BASI NON SONO COMPRENSIVE DI TOP
THE BASE UNITS DO NOT INCLUDE THE TOPS

	COD.	FASCIA A K80	FASCIA B K80				
 <p>anta con fianco per frigo e congelatore sottotop door with side panel for under-top fridge and freezer</p>							
	L 60 E4490151/2	181	247				
 <p>anta per frigo e congelatore sottotop door for under-top fridge and freezer</p>							
	L 60 E4490181/2	156	222				
 <p>fianco per elettrodomestici a fine composizione side panel for appliances placed at the end of the composition</p>							
	<p>in nobilitato melamine coated H 85x60x1,8 zoccolo H 13 H 85x60x2 plinth H 13</p>	T94613	25	25			
	<p>come anta same as door H 85x59,6x1,8 zoccolo H 13 H 85x59,8x2 plinth H 13</p>	T94713	147	147			

BASI H 73

BASE UNITS H 73

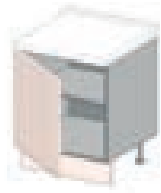
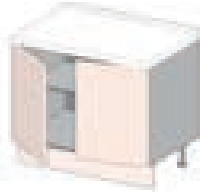

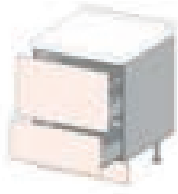
H 73 P 61

LE BASI NON SONO COMPRENSIVE DI TOP THE BASE UNITS DO NOT INCLUDE THE TOPS		COD.	FASCIA A K80	FASCIA B K80				
 <p>base H 73 1 anta base unit H 73 1 door</p>	L 45	E4030451/2	207	255				
	L 60	E4030601/2	235	291				
	L 90	E4030900	357	454				
 <p>base H 73 2 ante base unit H 73 2 doors</p>	L 45	E4250450	381	446				
	L 60	E4250600	419	493				
	L 90	E4250900	508	605				
 <p>base H 73 2 cassetti H 18 1 cassetto H 24 base unit H 73 2 drawers H 18 1 drawer H 24</p>	L 45	E4260450	349	419				
	L 60	E4260600	380	459				
	L 90	E4260900	452	549				
 <p>base H 73 1 cestone H 36 1 cassetto H 24 base unit H 73 1 deep drawers H 36 1 drawer H 24</p>	L 45	E4260450	349	419				
	L 60	E4260600	380	459				
	L 90	E4260900	452	549				

SOTTOLAVELLI H 73

SINK BASE UNIT H 73

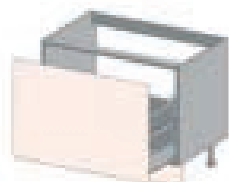
LE BASI NON SONO COMPRENSIVE DI TOP
THE BASE UNITS DO NOT INCLUDE THE TOPS

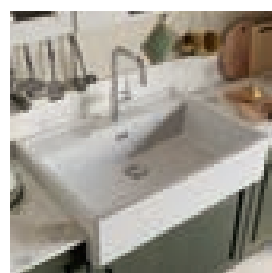
	COD.	FASCIA A K80	FASCIA B K80			
 <p>sottolavello H 73 1 anta skin base unit H 73 1 door</p>	L 60	E5060601/2	231	286		
	2 ante L 90 2 doors	E5060900	344	438		
 <p>sottolavello H 73 1 cestone H 60 con scarico salvaspazio skin base unit H 73 1 deep drawer H 60 with space-saver drain piping</p>	L 60	E5260600	306	361		
	L 90	E5260900	356	427		
 <p>lavello Bianco in ceramica L 59,8 P 63 H 22 1 vasca con foro rubinetto colore bianco Blanco ceramic sink W 59,8 P 63 H 22 1 bowl sink with hole of the tap white colour</p>	L 59,8 P 63	07069910	1.133	1.133		
	L 90 P 63,5	07176A01	956	956		
 <p>lavello Elleci in composito P 63,5 H 20,5 1 vasca con foro rubinetto N.B.: disponibile nei colori White (opz.K86A), Black (opz.K96A) e Light Grey (opz.K97) Elleci composit sink P 63,5 H 20,5 1 bowl sink with hole of the tap Note: available colours White (opt.K86A), Black (opt.K96A) and Light Grey (opt.K97)</p>	L 90 P 63,5	07176A01	956	956		

Disegno tecnico
lavello Bianco
Technical drawing
Blanco sink

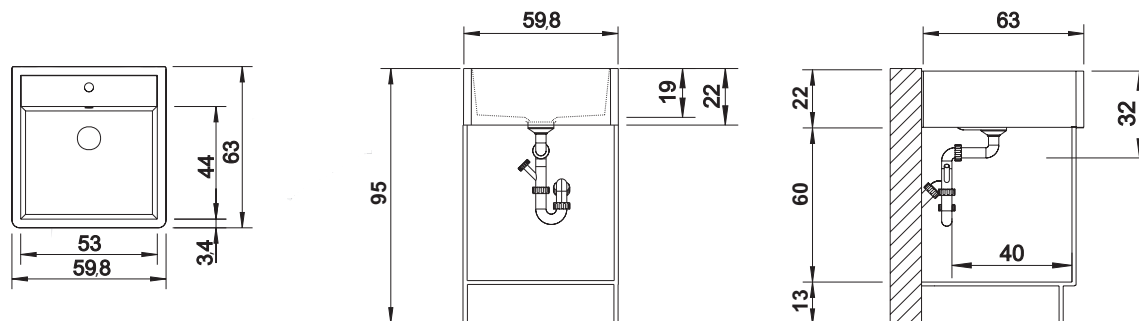



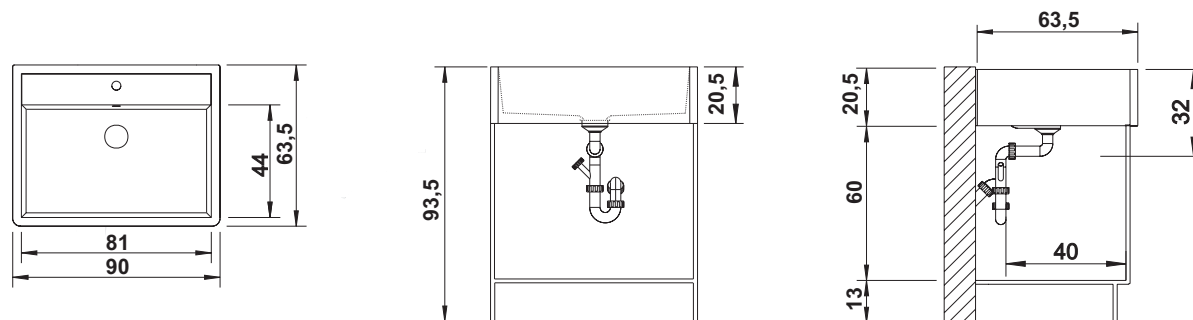

Disegno tecnico
lavello Elleci
Technical drawing
Elleci sink



BASI SOSPENSE con Attaccaglie e Barre Fissaggio a parete

H 36 - 48 - 60 P 61

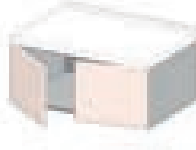



HANGING BASE UNITS with Hangers and Rods for wall mounting

LE BASI NON SONO COMPRENSIVE DI TOP THE BASE UNITS DO NOT INCLUDE THE TOPS		COD.	FASCIA A K80	FASCIA B K80				
 <p>base H 36 1 anta base unit H 36 1 door</p>	L 45	E4321451/2	178	215				
	L 60	E4321601/2	198	241				
 <p>base H 48 1 anta base unit H 48 1 door</p>	L 45	E4320451/2	206	249				
	L 60	E4320601/2	230	279				
 <p>base H 60 1 anta base unit H 60 1 door</p>	L 45	E4322451/2	223	270				
	L 60	E4322601/2	250	305				
 <p>base H 36 2 ante base unit H 36 2 doors</p>	L 90	E4321900	288	364				
	L 120	E4322200	324	410				
 <p>base H 48 2 ante base unit H 48 2 doors</p>	L 90	E4320900	336	421				
	L 120	E4321200	394	492				
 <p>base H 60 2 ante base unit H 60 2 doors</p>	L 90	E4322900	363	458				

BASI SOSPESSE con Attaccaglie e Barre Fissaggio a parete

H 36 - 48 - 60 P 61







HANGING BASE UNITS with Hangers and Rods for wall mounting

LE BASI NON SONO COMPRENSIVE DI TOP THE BASE UNITS DO NOT INCLUDE THE TOPS		COD.	FASCIA A K80	FASCIA B K80			
 <p>base H 36 1 cestone base H 36 1 deep drawer</p>	L 45	E4311450	226	264			
	L 60	E4311600	250	292			
	L 90	E4311900	291	344			
 <p>base H 48 1 cestone base unit H 48 1 deep drawer</p>	L 45	E4310450	246	288			
	L 60	E4310600	272	321			
	L 90	E4310900	320	381			
 <p>base H 60 1 cestone 1 cassetto interno base unit H 60 1 deep drawer 1 internal drawer</p>	L 45	E4312450	387	434			
	L 60	E4312600	403	458			
 <p>sottolavello H 48 1 cestone sagomato scarico salvaspazio sink base unit H 48 1 contoured deep drawer space-saver drain piping</p>	L 90	E5240900	351	413			
 <p>sottolavello H 60 1 cestone scarico salvaspazio sink base unit H 60 1 deep drawer with space-saver drain piping</p>	L 60	E5250600	311	366			

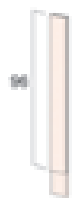
COLONNE H 109

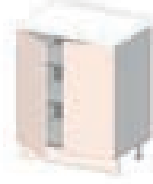
COLUMNS H 109





P 59,7

LE COLONNE NON SONO COMPRENSIVE DI TOP THE COLUMNS DO NOT INCLUDE THE TOPS		COD.	FASCIA A K80	FASCIA B K80					
 <p>fascia tamponamento da 5 a 10 filler panel size from 5 to 10</p>									
		in nobilitato melamine coated	E6000010	50	50				
		come anta con supporto same as door with support	E6000140	117	159				
 <p>1 anta 1 door</p>									
	L 30	E6040301/2	234	284					
	L 40	E6040401/2	262	321					
	L 45	E6040451/2	272	335					
	L 60	E6040601/2	315	390					
 <p>2 ante 2 ripiani con tirante centrale 2 doors 2 shelves with central tie beam</p>									
	L 90	E6041900	469	594					
 <p>1 anta vetro 1 glass door</p>									
	L 45	E6046451/2	354	446					
 <p>2 ante vetro 2 glass doors</p>									
	L 90	E6046900	638	821					
 <p>1 cassetto H 24 2 cestoni H 36 1 drawer H 24 2 deep drawers H 36</p>									
	L 60	E6031620	552	675					

COLONNE H 145

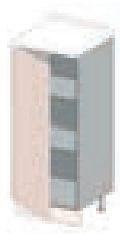
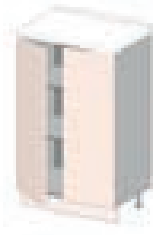
COLUMNS H 145

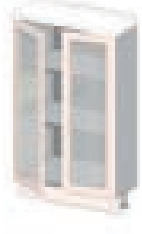



P 33,2 - 59,7

LE COLONNE NON SONO COMPRENSIVE DI TOP THE COLUMNS DO NOT INCLUDE THE TOPS		COD.	FASCIA A K80	FASCIA B K80				
 <p>fascia tamponamento da 5 a 10 filler panel size from 5 to 10</p>								
	<p>in nobilitato melamine coated come anta con supporto same as door with support</p>	E6000020	51	51				
		E6000150	215	306				
 <p>1 anta 1 door</p>								
	<p>L 45 P 59,7 L 60 P 59,7</p>	E6050451/2	326	404				
		E6050601/2	374	467				
 <p>2 ante 2 ripiani con tirante centrale 2 doors 2 shelves with central tie beam</p>								
	<p>L 90 P 59,7</p>	E6050900	568	723				
 <p>1 anta vetro 1 glass door</p>								
	<p>L 45 P 33,2 L 60 P 33,2</p>	E6180461/2	462	597				
		E6180611/2	493	638				
 <p>2 ante vetro 2 glass doors</p>								
	<p>L 90 P 33,2</p>	E6180910	815	1.085				
 <p>1 anta vetro 1 glass door</p>								
	<p>L 45 P 59,7 L 60 P 59,7</p>	E6180451/2	465	600				
		E6180601/2	504	649				
 <p>2 ante vetro 2 glass doors</p>								
	<p>L 90 P 59,7</p>	E6180900	849	1.119				

COLONNE H 145

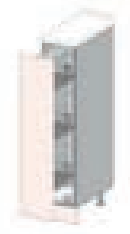
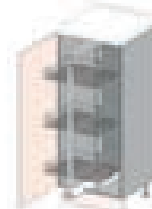
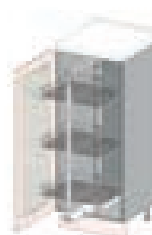
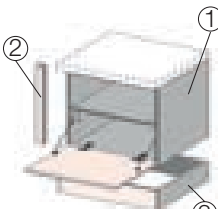
COLUMNS H 145



P 59,7

LE COLONNE NON SONO COMPRENSIVE DI TOP THE COLUMNS DO NOT INCLUDE THE TOPS		COD.	FASCIA A K80	FASCIA B K80				
 <p>1 anta integrata al gruppo cestelli estraibili in filo orion grau chiusura soft 1 door incorporated into the orion grau wire pull-out basket units soft-closing system</p>	L 30	E6150300	616	676				
 <p>1 anta gruppo cestelli estraibili in filo orion grau chiusura soft 1 door orion grau wire pull-out basket units soft-closing system</p>	L 45	E6150451/2	668	745				
	L 60	E6150601/2	720	812				
 <p>1 anta vetro gruppo cestelli estraibili in filo orion grau chiusura soft 1 glass door orion grau wire pull-out basket units soft-closing system</p>	L 45	E6152451/2	816	952				
	L 60	E6152601/2	860	1.007				
 <p>mobile H 57 L 65 apertura a vasistas push-pull con fascia di tamponamento laterale e inferiore in appoggio su base angolo unit H 57 W 65 flap door push-pull opening with lateral and lower filler panel resting on corser base unit</p> <p>verso sx LH version</p>								
		1. elemento H 48 L 60 wall unit H 48 W 60	E2520600	357	399			
		2. fascia laterale H 48 L 5 lateral filler panel H 48 W 5	E278000A	96	130			
	3. fascia inferiore H 12 L 65 lower filler panel H 12 W 65	E2882000	109	143				
 <p>Esempio di mobile in appoggio su base angolo con colonna H 132 affiancata Example of unit resting on corser base unit with side by side column H 132</p> <p>verso sx LH version</p>								
 <p>angolo 2 ripiani 1 anta pannello liscio sp.2 come anta corner unit 2 shelves 1 door panel without frame Th. 2 same as door</p>	L 110	E6336101/2	663	739				
	L 125	E6336251/2	702	793				
 <p>jolly colonna L da 10 a 30 jolly column size from 10 to 30</p>								
		in nobilitato melamine coated	E6001000	237	237			
	impiallacciato veneered	E6005100	495	495				

COLONNE H 217

COLUMNS H 217



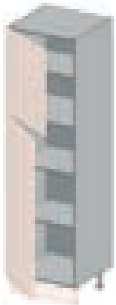
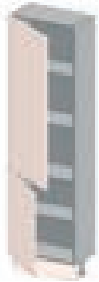
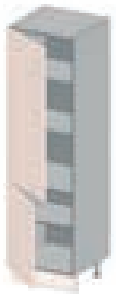
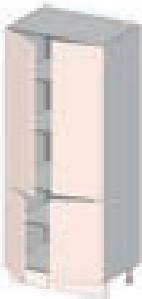

P 33,2 - 59,7

		COD.	FASCIA A K80	FASCIA B K80				
 <p>fascia tamponamento da 5 a 10 filler panel size from 5 to 10</p>								
		in nobilitato melamine coated	E6000050	58	58			
		come anta con supporto same as door with support	E6000200	215	306			
 <p>2 ante anta superiore H 72 anta inferiore H 132 2 doors upper door H 72 lower door H 132</p>								
	L 45 P 33,2	E601345A1/2	468	600				
	L 60 P 33,2	E601360A1/2	548	712				
 <p>2 ante anta superiore H 72 anta inferiore H 132 2 doors upper door H 72 lower door H 132</p>								
	L 30 P 59,7	E606030A1/2	433	540				
	L 45 P 59,7	E606345A1/2	501	633				
	L 60 P 59,7	E606360A1/2	594	757				
	L 75 P 59,7	E606375A1/2	707	898				
 <p>2 ante anta superiore H 132 anta inferiore H 72 2 doors upper door H 132 lower door H 72</p>								
	L 45 P 33,2	E601045A1/2	468	600				
	L 60 P 33,2	E601060A1/2	548	712				
 <p>2 ante anta superiore H 132 anta inferiore H 72 2 doors upper door H 132 lower door H 72</p>								
	L 45 P 59,7	E606045A1/2	501	633				
	L 60 P 59,7	E606060A1/2	594	757				
 <p>4 ante 2 ante superiori H 132 2 ante inferiori H 72 4 ripiani con tirante centrale 4 doors 2 upper doors H 132 2 lower doors H 72 4 shelves with central tie beam</p>								
	L 90 P 59,7	E606090A0	881	1.139				

COLONNE H 217

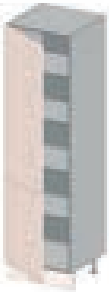
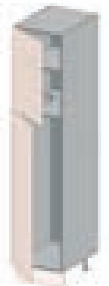
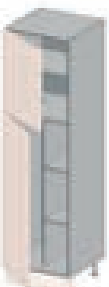
COLUMNS H 217







P 59,7

		COD.	FASCIA A K80	FASCIA B K80			
 <p>1 anta H 204 (132+72) 1 door H 204 (132+72)</p>	L 45	E6061451/2	525	656			
	L 60	E6061601/2	617	781			
 <p>portascope 2 ante anta superiore H 72 anta inferiore H 132 broom cabinet 2 doors upper door H 72 lower door H 132</p>	L 30	E610030A1/2	434	541			
	L 45	E610045A1/2	495	626			
 <p>portascope con ripiani 2 ante anta superiore H 72 anta inferiore H 132 broom cabinet with shelves 2 doors upper door H 72 lower door H 132</p>	L 60	E610060A1/2	622	786			
 <p>1 anta H 132 4 cassetti H 18 1 door H 132 4 drawers H 18</p>	L 45	E6065451/2	698	836			
	L 60	E6065601/2	783	948			
 <p>1 anta H 132 2 cassetti H 18 1 cestone H 36 1 door H 132 2 drawers H 18 1 deep drawer H 36</p>	L 45	E6065461/2	665	809			
	L 60	E6065611/2	745	917			
 <p>1 anta H 132 2 cestoni H 36 1 door H 132 2 deep drawers H 36</p>	L 45	E6066451/2	631	783			
	L 60	E6066601/2	709	886			

COLONNE H 217

COLUMNS H 217



P 33,2 - 59,7

		COD.	FASCIA A K80	FASCIA B K80				
 <p>2 ante anta vetro H 132 anta chiusa H 72 2 doors glass door H 132 full door H 72</p>	L 45 P 33,2	E6202451/2	598	783				
	L 60 P 33,2	E6202601/2	653	859				
 <p>2 ante anta vetro H 132 anta chiusa H 72 2 doors glass door H 132 full door H 72</p>	L 45 P 59,7	E6201451/2	628	813				
	L 60 P 59,7	E6201601/2	693	900				
 <p>4 ante 2 ante vetro H 132 2 ante chiuse H 72 4 doors 2 glass doors H 132 2 full doors H 72</p>	L 90 P 59,7	E6201900	1.162	1.532				
 <p>1 anta vetro H 132 4 cassetti H 18 1 glass door H 132 4 drawers H 18</p>	L 45 P 59,7	E6284451/2	844	1.041				
	L 60 P 59,7	E6284601/2	922	1.140				
 <p>1 anta vetro H 132 2 cassetti H 18 1 cestone H 36 1 glass door H 132 2 drawers H 18 1 deep drawer H 36</p>	L 45 P 59,7	E6284461/2	811	1.014				
	L 60 P 59,7	E6284611/2	885	1.109				
 <p>1 anta vetro H 132 2 cestoni H 36 1 glass door H 132 2 deep drawers H 36</p>	L 45 P 59,7	E6285451/2	777	988				
	L 60 P 59,7	E6285601/2	846	1.077				

COLONNE H 217

COLUMNS H 217

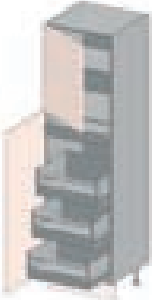
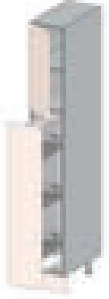
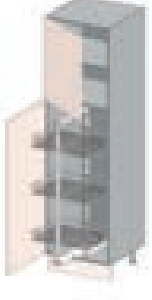
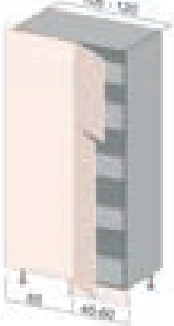
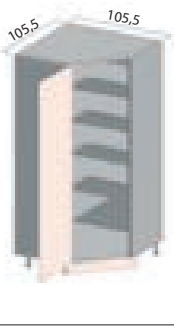



P 59,7

		COD.	FASCIA A K80	FASCIA B K80			
 <p>1 anta superiore H 72 1 anta inferiore H 132 1 cassetto interno 3 cestoni interni posizionare sempre a 5 cm dalla parete laterale 1 upper door H 72 1 lower door H 132 1 internal drawer 3 internal deep drawers should always be placed at 5 cm from the side wall</p>	L 45	E608648A1/2	804	930			
	L 60	E608663A1/2	881	1.035			
 <p>1 anta superiore H 72 1 anta H 132 integrata al gruppo cestelli estraibili in filo orion grau chiusura soft 1 upper door H 72 1 door H 132 incorporated into the orion grau wire pull-out basket units soft-closing system</p>	L 30	E616030A1/2	767	871			
 <p>1 anta superiore H 72 1 anta inferiore H 132 gruppo cestelli estraibili in filo orion grau chiusura soft 1 upper door H 72 1 lower door H 132 orion grau wire pull-out basket units soft-closing system</p>	L 45	E616045A1/2	840	967			
	L 60	E616060A1/2	919	1.074			
 <p>angolo 4 ripiani 1 anta superiore H 72 1 anta inferiore H 132 pannello liscio sp.2 come anta corner unit 4 shelves 1 upper door H 72 1 lower door H 132 panel without frame Th. 2 same as door</p>	L 110	E6306101/2	992	1.118			
	L 125	E6306251/2	1.054	1.207			
 <p>angolo 1 anta H 204 (132+72) 2 fianchi sp. 3,8 come struttura N.B.: fornita smontata corner 1 door H 204 (132+72) 2 side panels Th.3,8 same as carcass Note: supplied unassembled</p>	105,5x105,5	E6341051/2	1.190	1.343			
	con fianchi sp.3,8 impiallacciati veneered side Th.3,8	E6341061/2	2.067	2.220			
 <p>jolly colonna L da 15 a 30 jolly column size from 15 to 30</p>	in nobilitato melamine coated	E6002000	323	323			
	impiallacciato veneered	E6005200	873	873			

COLONNE H 241

COLUMNS H 241



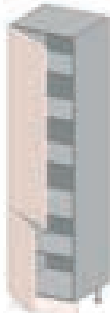
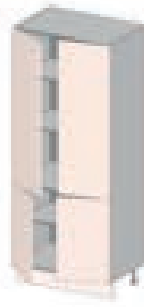

P 33,2 - 59,7

	COD.	FASCIA A K80	FASCIA B K80				
 <p>fascia tamponamento da 5 a 10 filler panel size from 5 to 10</p>							
	in nobilitato melamine coated	E6000100	58	58			
	come anta con supporto same as door with support	E6000250	234	335			
 <p>2 ante anta superiore H 96 anta inferiore H 132 2 doors upper door H 96 lower door H 132</p>							
	L 45 P 33,2	E602345A1/2	514	657			
	L 60 P 33,2	E602360A1/2	603	780			
 <p>2 ante anta superiore H 96 anta inferiore H 132 2 doors upper door H 96 lower door H 132</p>							
	L 30 P 59,7	E607030A1/2	467	582			
	L 45 P 59,7	E607345A1/2	547	690			
	L 60 P 59,7	E607360A1/2	651	828			
 <p>2 ante anta superiore H 156 anta inferiore H 72 2 doors upper door H 156 lower door H 72</p>							
	L 45 P 33,2	E602045A1/2	538	693			
	L 60 P 33,2	E602060A1/2	599	776			
 <p>2 ante anta superiore H 156 anta inferiore H 72 2 doors upper door H 156 lower door H 72</p>							
	L 45 P 59,7	E607045A1/2	572	727			
	L 60 P 59,7	E607060A1/2	646	823			
 <p>4 ante 2 ante superiori H 156 2 ante inferiori H 72 4 ripiani con tirante centrale 4 doors 2 upper doors H 156 2 lower doors H 72 4 shelves with central tie beam</p>							
	L 90 P 59,7	E607090A0	1.009	1.313			

COLONNE H 241

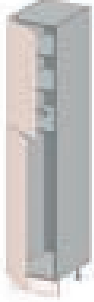
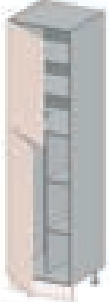
COLUMNS H 241





P 59,7

		COD.	FASCIA A K80	FASCIA B K80				
 <p>portascope 1 anta superiore H 96 1 anta inferiore H 132 broom cabinet 1 upper door H 96 1 lower door H 132</p>	L 30	E611030A1/2	469	583				
	L 45	E611045A1/2	541	684				
 <p>portascope con ripiani 1 anta superiore H 96 1 anta inferiore H 132 broom cabinet with shelves 1 upper door H 96 1 lower door H 132</p>	L 60	E611060A1/2	679	856				
 <p>1 anta H 156 4 cassetti H 18 1 door H 156 4 drawers H 18</p>	L 45	E6075451/2	765	927				
	L 60	E6075601/2	831	1.008				
 <p>1 anta H 156 2 cassetti H 18 1 cestone H 36 1 door H 156 2 drawers H 18 1 deep drawer H 36</p>	L 45	E6075461/2	732	900				
	L 60	E6075611/2	794	978				
 <p>1 anta H 156 2 cestoni H 36 1 door H 156 2 deep drawers H 36</p>	L 45	E6076451/2	698	873				
	L 60	E6076601/2	757	947				
 <p>jolly colonna L da 15 a 30 jolly column size from 15 to 30</p>								
		in nobilitato melamine coated	E6003000	341	341			
		impiallacciato veneered	E6005250	902	902			

COLONNE H 241

COLUMNS H 241

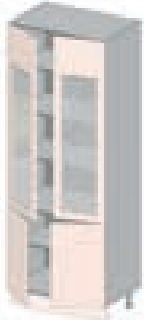
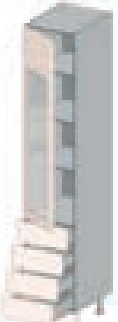



P 33,2 - 59,7

		COD.	FASCIA A K80	FASCIA B K80			
 <p>2 ante anta vetro con bugna H 156 (anta unita 132 vetro+24 piena) anta chiusa H 72 2 doors glass door with rise panel H 156 full door H 72</p>	L 45 P 33,2	E6212451/2	679	897			
	 <p>2 ante anta vetro con bugna H 156 (anta unita 132 vetro+24 piena) anta chiusa H 72 2 doors glass door with rise panel H 156 full door H 72</p>	L 45 P 59,7	E6211451/2	712	930		
 <p>4 ante 2 ante vetro con bugna H 156 (anta unita 132 vetro+24 piena) 2 ante chiuse H 72 4 doors 2 glass doors with rise panel H 156 2 full doors H 72</p>		L 90 P 59,7	E6211900	1.319	1.755		
	 <p>1 anta vetro con bugna H 156 (anta unita 132 vetro+24 piena) 4 cassetti H 18 1 glass door with rise panel H 156 4 drawers H 18</p>	L 45 P 59,7	E6294451/2	928	1.158		
 <p>1 anta vetro con bugna H 156 (anta unita 132 vetro+24 piena) 2 cassetti H 18 1 cestone H 36 1 glass door with rise panel H 156 2 drawers H 18 1 deep drawer H 36</p>		L 45 P 59,7	E6294461/2	894	1.131		
	 <p>1 anta vetro con bugna H 156 (anta unita 132 vetro+24 piena) 2 cestoni H 36 1 glass door with rise panel H 156 2 deep drawers H 36</p>	L 45 P 59,7	E6295451/2	861	1.104		

COLONNE H 241

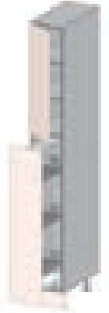
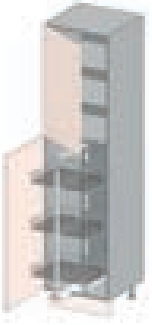
COLUMNS H 241

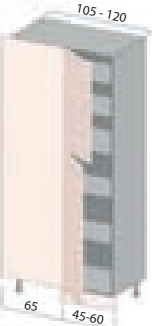



P 59,7

		COD.	FASCIA A K80	FASCIA B K80				
 <p>1 anta superiore H 96 1 anta H 132 integrata al gruppo cestelli estraibili in filo orion grau chiusura soft 1 upper door H 96 1 door H 132 incorporated into the orion grau wire pull-out basket units soft-closing system</p>	L 30	E617030A1/2	800	911				
	 <p>1 anta superiore H 96 1 anta inferiore H 132 gruppo cestelli estraibili in filo orion grau chiusura soft 1 upper door H 96 1 lower door H 132 orion grau wire pull-out basket units soft-closing system</p>	L 45	E617045A1/2	885	1.024			
L 60		E617060A1/2	973	1.140				
 <p>1 anta superiore H 96 1 anta inferiore H 132 4 cestelli orion grau estraibili singolarmente chiusura soft 1 upper door H 96 1 lower door H 132 4 independent orion grau basket units soft-closing system</p>		L 45	E617545A1/2	843	982			
	L 60	E617560A1/2	941	1.108				
	 <p>angolo 5 ripiani 1 anta superiore H 96 1 anta inferiore H 132 pannello liscio sp. 2 come anta corner unit 5 shelves 1 upper door H 96 1 lower door H 132 panel without frame Th. 2 same as door</p>	L 110	E6316101/2	1.089	1.227			
L 125		E6316251/2	1.163	1.328				
 <p>angolo 1 anta H 228 (156+72) 2 fianchi sp. 3,8 come struttura N.B.: fornita smontata corner 1 door H 228 (156+72) 2 side panels Th.3,8 same as carcass Note: supplied unassembled</p>		105,5x105,5	E6342051/2	1.325	1.490			
	con fianchi sp.3,8 impiallacciati veneered side th.3,8	E6342061/2	2.305	2.470				

COLONNE PER FORNO H 109

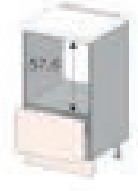
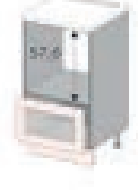
P 59,7



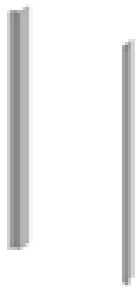

OVEN COLUMNS H 109

LE COLONNE NON SONO COMPRENSIVE DI TOP THE COLUMNS UNITS DO NOT INCLUDE THE TOPS		COD.	FASCIA A K80	FASCIA B K80				
 <p>colonna H 109 per forno 2 cassetti H 18 oven column H 109 2 drawers H 18</p>	L 60	E6501660	339	376				
	 <p>colonna H 109 per forno 1 cestone chiuso H 36 oven column H 109 1 full deep drawer H 36</p>	L 60	E6501600	302	345			
 <p>colonna H 109 per forno 1 cestone vetro H 36 oven column H 109 1 glass deep drawer H 36</p>		L 45	E6501610	361	425			
	 <p>top in laminato H 4 P 61 per colonne laminated top H 4 D 61 for columns</p>			VEDI	VEDI			
al ml per lm		T90035	LISTINO	LISTINO				
mag.griglia di areazione cad. surcharge for ventilation grille each			TOP	TOP				
 <p>profilo in acciaio a "L" per rifinire il ripiano del forno e del microonde L-shaped steel finishing profile for shelf of oven and microwave</p> 	L 60							
	inox stainless steel	08660100	9	9				
	nero black	08660101	9	9				
	bianco white	08660102	9	9				
 <p>kit protezione fianchi per forno protection kit sides for oven</p> 	L 90							
	inox stainless steel	08660105	12	12				
	coppia couple	08630095	16	16				

COLONNE PER FORNO H 145

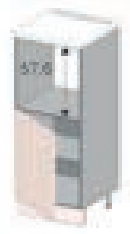
P 59,7

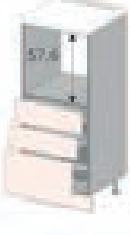
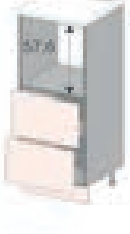
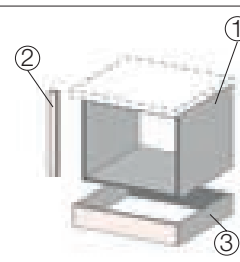



OVEN COLUMNS H 145

LE COLONNE NON SONO COMPRENSIVE DI TOP THE COLUMNS UNITS DO NOT INCLUDE THE TOPS		COD.	FASCIA A K80	FASCIA B K80				
 <p>colonna H 145 per forno 1 anta H 72 oven column H 145 1 door H 72</p>	L 60	E6520601/2	322	384				
	L 75	E6520751/2	369	440				
 <p>colonna H 145 per forno 4 cassetti H 18 oven column H 145 4 drawers H 18</p>	L 60	E6521610	546	620				
	L 60	E6521620	509	589				
 <p>colonna H 145 per forno 2 cassetti H 18 1 cestone H 36 oven column H 145 2 drawers H 18 1 deep drawer H 36</p>	L 60	E6521630	475	561				
	L 60	E6521630	475	561				
 <p>colonna H 145 per forno 2 cestoni H 36 oven column H 145 2 deep drawers H 36</p>	L 90	E6521910	581	719				
	L 90	E6521910	581	719				
 <p>mobile H 57 L 65 per micro con fascia di tamponamento laterale e inferiore in appoggio su base angolo unit H 57 W 65 flap door push-pull opening with lateral and lower filler panel resting on corser base unit</p> <p>verso sx LH version</p>								
		1. elemento per micro H 47,5 L 60 micro unit H 47,5 W 60	E2521600	127	144			
		2. fascia laterale H 47,5 L 5 lateral filler panel H 47,5 W 5	E278000B	96	130			
	3. fascia inferiore H 12,5 L 65 lower filler panel H 12,5 W 65	E2882100	109	143				
 <p>Esempio di mobile per micro in appoggio su base angolo con colonna H 132 affiancata Example of micro unit resting on corser base unit with side by side column H 132</p> <p>verso sx LH version</p>								

COLONNE PER FORNO H 217

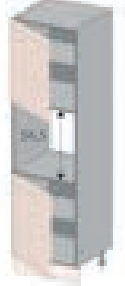
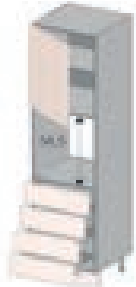
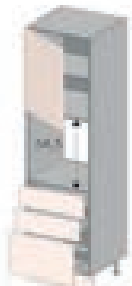
P 59,7

OVEN COLUMNS H 217

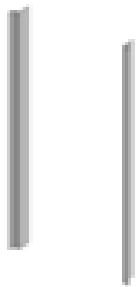
		COD.	FASCIA A K80	FASCIA B K80				
 <p>colonna per forno 1 anta superiore H 72 1 anta inferiore H 72 oven column 1 upper door H 72 1 lower door H 72</p>	L 60	E653060A1/2	522	645				
	L 75	E653075A1/2	608	750				
 <p>colonna per forno 1 anta H 72 4 cassetti H 18 oven column 1 door H 72 4 drawers H 18</p>	L 60	E6531611/2	764	898				
	L 60	E6531621/2	726	868				
 <p>colonna per forno 1 anta H 72 2 cassetti H 18 1 cestone H 36 oven column 1 door H 72 2 drawers H 18 1 deep drawer H 36</p>	L 60	E6531631/2	689	837				
	L 60	E6531631/2	689	837				
 <p>profilo in acciaio a "L" per rifinire il ripiano del forno e del microonde L-shaped steel finishing profile for shelf of oven and microwave</p> 	L 60							
	inox stainless steel	08660100	9	9				
	nero black	08660101	9	9				
	bianco white	08660102	9	9				
 <p>kit protezione fianchi per forno protection kit sides for oven</p> 	coppia couple	08630095	16	16				

COLONNE PER FORNO H 217

P 59,7



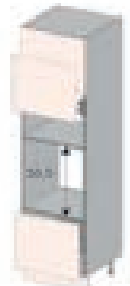
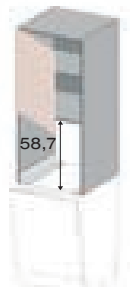
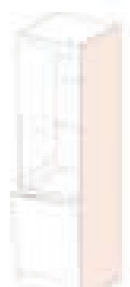

OVEN COLUMNS H 217

		COD.	FASCIA A K80	FASCIA B K80			
 <p>colonna per forno e micro 1 anta superiore H 48 1 vano micro da H 36,5 a 46,5 1 cestone H 48 oven and microwave column 1 upper door H 48 1 microwave compartment H 36,5 to 46,5 1 deep drawer H 48</p>	L 60	E6551601/2	584	700			
	 <p>colonna per forno 1 anta superiore H 48 1 anta H 48 sollevamento verticale 1 cestone H 48 oven column 1 upper door H 48 1 door H 48 vertical opening 1 deep drawer H 48</p>	L 60	E655460A1/2	736	884		
 <p>colonna forno sospesa H 132 per lavastoviglie 1 anta H 72 hanging oven column H 132 for dishwasher 1 door H 72</p>		L 60	E6576601/2	361	423		
	 <p>fianco per elettrodomestici a fine composizione side panel for appliances placed at the end of the composition</p>						
<p>come anta same as door H 217x59,8x2</p>			1K804180	374	374		

COLONNE PER FORNO H 241

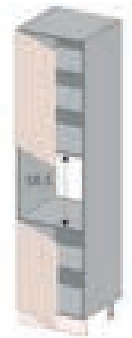
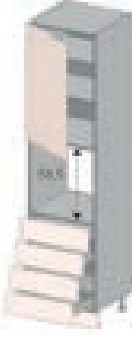
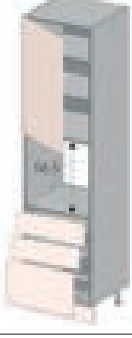
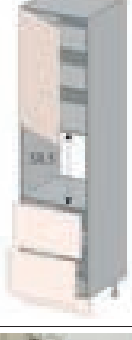
P 59,7

OVEN COLUMNS H 241

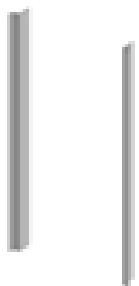
		COD.	FASCIA A K80	FASCIA B K80				
 <p>colonna per forno 1 anta superiore H 96 1 anta inferiore H 72 oven column 1 upper door H 96 1 lower door H 72</p>								
	L 60	E654060A1/2	577	713				
 <p>colonna per forno 1 anta H 96 4 cassetti H 18 oven column 1 door H 96 4 drawers H 18</p>								
	L 60	E6541611/2	804	951				
 <p>colonna per forno 1 anta superiore H 96 2 cassetti H 18 1 cestone H 36 oven column 1 upper door H 96 2 drawers H 18 1 deep drawer H 36</p>								
	L 60	E6541621/2	767	920				
 <p>colonna per forno 1 anta superiore H 96 2 cestoni H 36 oven column 1 upper door H 96 2 deep drawers H 36</p>								
	L 60	E6541631/2	730	889				
 <p>profilo in acciaio a "L" per rifinire il ripiano del forno e del microonde L-shaped steel finishing profile for shelf of oven and microwave</p> 								
	L 60							
	inox stainless steel	08660100	9	9				
	nero black	08660101	9	9				
bianco white	08660102	9	9					
 <p>kit protezione fianchi per forno protection kit sides for oven</p> 								
	coppia couple	08630095	16	16				

COLONNE PER FORNO H 241

P 59,7

OVEN COLUMNS H 241

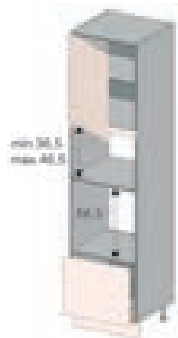
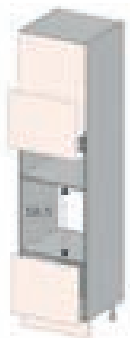
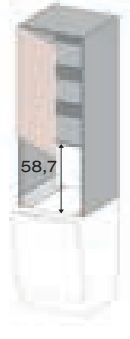
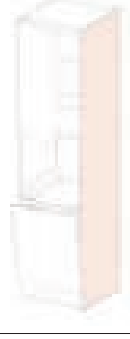
		COD.	FASCIA A K80	FASCIA B K80			
 <p>colonna per forno e micro 1 anta superiore H 72 1 vano micro da H 36,5 a 46,5 1 cestone H 48 oven and microwave column 1 upper door H 72 1 microwave compartment H 36,5 to 46,5 1 deep drawer H 48</p>	L 60	E6561601/2	621	750			
	 <p>colonna per forno 1 anta superiore H 72 1 anta H 48 sollevamento verticale 1 cestone H 48 oven column 1 upper door H 72 1 door H 48 vertical opening 1 deep drawer H 48</p>	L 60	E656460A1/2	787	948		
 <p>colonna forno sospesa H 156 per lavastoviglie 1 anta H 96 hanging oven column H 156 for dishwasher 1 door H 96</p>		L 60	E6577601/2	424	498		
	 <p>fianco per elettrodomestici a fine composizione side panel for appliances placed at the end of the composition</p>						
<p>come anta same as door H 241x59,8x2</p>			1K804183	415	415		

COLONNE PER FRIGO H 145 - 217

P 59,7

FRIDGE COLUMNS H 145 - 217

LE COLONNE NON SONO COMPRENSIVE DI TOP THE COLUMNS UNITS DO NOT INCLUDE THE TOPS		COD.	FASCIA A K80	FASCIA B K80			
 <p>colonna H 145 per frigo 215 monoporta column H 147 for single-door fridge 215</p>							
	L 60	E6452151/2	394	488			
 <p>colonna H 217 per frigo 215 monoporta 1 anta superiore H 72 1 anta inferiore H 132 column H 219 for 215 single-door fridge 1 upper door H 72 lower door H 132</p>							
	L 60	E646215A1/2	558	717			
 <p>colonna H 217 per frigo-freezer 230 1 anta superiore H 84 1 anta inferiore H 120 column H 219 for 230 fridge-freezer 1 upper door H 84 1 lower door H 120</p>							
	L 60	E646231A1/2	558	717			
 <p>colonna H 217 per frigo-freezer 280 1 anta superiore H 84 1 anta inferiore H 120 column H 217 for 280 fridge-freezer 1 upper door H 84 1 lower door H 120</p>							
	L 60	E646286A1/2	558	717			
 <p>colonna H 217 per frigo-congelatore 315 1 anta superiore H 132 1 anta inferiore H 72 column H 217 for 315 fridge-freezer 1 upper door H 132 1 lower door H 72</p>							
	L 60	E646315A1/2	558	717			
 <p>colonna H 217 per frigo-congelatore 315 1 anta superiore H 24 1 anta centrale H 108 1 anta inferiore H 72 column H 217 for 315 fridge-freezer 1 upper door H 24 1 central door H 108 1 lower door H 72</p>							
	L 60	E6463161/2	623	808			

COLONNE PER FRIGO H 217

FRIDGE COLUMNS H 217

P 59,7

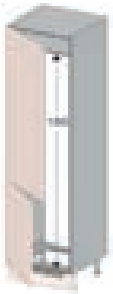
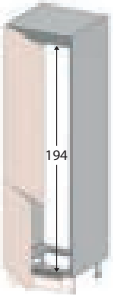
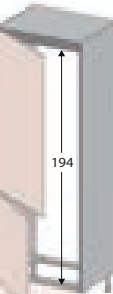
		COD.	FASCIA A K80	FASCIA B K80			
 <p>colonna H 217 per frigo-congelatore 330 1 anta superiore H 132 1 anta inferiore H 72 column H 217 for 330 fridge-freezer 1 upper door H 132 1 lower door H 72</p>							
	L 60	E646330A1/2	558	717			
 <p>colonna H 217 per frigo-congelatore 350 1 anta superiore H 132 1 anta inferiore H 72 column H 217 for 350 fridge-freezer 1 upper door H 132 1 lower door H 72</p>							
	L 60	E646351A1/2	558	717			
 <p>colonna H 217 per frigo-congelatore 400 1 anta superiore H 132 1 anta inferiore H 72 column H 217 for 400 fridge-freezer 1 upper door H 132 1 lower door H 72</p>							
	L 75	E646400A1/2	671	856			

COLONNE PER FRIGO H 241

FRIDGE COLUMNS H 241

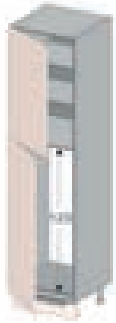
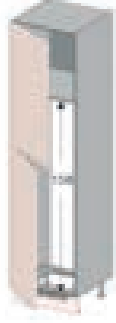

P 59,7



		COD.	FASCIA A K80	FASCIA B K80				
 <p>colonna H 241 per frigo 215 monoporta 1 anta superiore H 96 1 anta inferiore H 132 column H 241 for 215 single-door fridge 1 upper door H 96 1 lower door H 132</p>								
	L 60	E647215A1/2	643	766				
 <p>colonna H 241 per frigo-freezer 230 1 anta superiore H 108 1 anta inferiore H 120 column H 241 for 230 fridge-freezer 1 upper door H 108 1 lower door H 120</p>								
	L 60	E647231A1/2	594	766				
 <p>colonna H 241 per frigo-freezer 280 1 anta superiore H 108 1 anta inferiore H 120 column H 241 for 280 fridge-freezer 1 upper door H 108 1 lower door H 120</p>								
	L 60	E647286A1/2	594	766				
 <p>colonna H 241 per frigo-congelatore 315 1 anta superiore H 156 1 anta inferiore H 72 column H 241 for 315 fridge-freezer 1 upper door H 156 1 lower door H 72</p>								
	L 60	E647315A1/2	594	766				
 <p>colonna H 241 per frigo-congelatore 315 1 anta superiore H 48 1 anta centrale H 108 1 anta inferiore H 72 column H 241 for 315 fridge-freezer 1 upper door H 48 1 central door H 108 1 lower door H 72</p>								
	L 60	E6473161/2	659	857				
 <p>colonna H 241 per frigo-congelatore 330 1 anta superiore H 156 1 anta inferiore H 72 column H 241 for 330 fridge-freezer 1 upper door H 156 1 lower door H 72</p>								
	L 60	E647330A1/2	594	766				

COLONNE PER FRIGO H 241

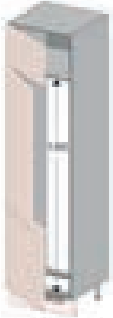
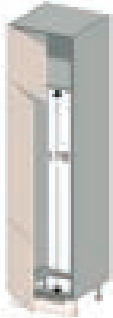
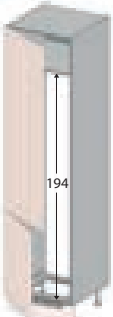
FRIDGE COLUMNS H 241



P 59,7

		COD.	FASCIA A K80	FASCIA B K80			
 <p>colonna H 241 per frigo-congelatore 330 1 anta superiore H 36 1 anta centrale H 120 1 anta inferiore H 72 column H 241 for 330 fridge-freezer 1 upper door H 36 1 central door H 120 1 lower door H 72</p>							
	L 60	E6473361/2	675	857			
 <p>colonna H 241 per frigo-congelatore 300 monoporta 1 anta superiore H 48 1 anta inferiore H 180 (108+72) column H 241 for 300 single-door fridge-freezer 1 upper door H 48 1 lower door H 180 (108+72)</p>							
	L 60	E647300A1/2	594	766			
 <p>colonna H 241 per frigo-congelatore 350 1 anta superiore H 156 1 anta inferiore H 72 column H 241 for 350 fridge-freezer 1 upper door H 156 1 lower door H 72</p>							
	L 60	E647351A1/2	594	766			
 <p>colonna H 241 per frigo-congelatore 400 1 anta superiore a ribalta H 24 TIP-ON 1 anta centrale H 132 1 anta inferiore H 72 column H 241 for 400 fridge-freezer 1 upper flap door H 24 TIP-ON 1 central door H 132 1 lower door H 72</p>							
	L 75	E6474101/2	797	1.020			

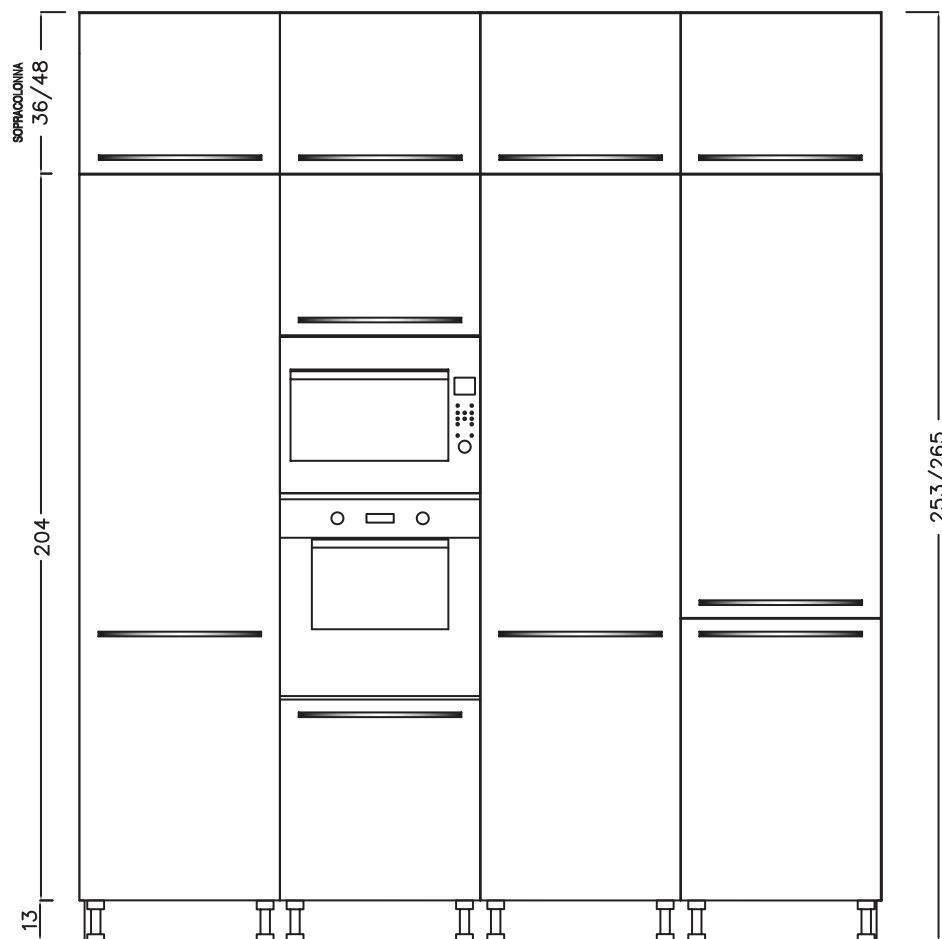
		COD.	FASCIA A K80	FASCIA B K80				
 <p>sopracolonna 1 anta top column 1 door</p>	H 36 L 45	EC601451/2	189	227				
	L 60	EC601601/2	208	251				
	ribalta TIP-ON L 75 flap door TIP-ON	EC61076T	283	333				
	H 48 L 45	EC602451/2	210	253				
	L 60	EC602601/2	238	288				
	ribalta TIP-ON L 75 flap door TIP-ON	EC61276T	325	381				
 <p>sopracolonna 1 anta vetro top column 1 glass door</p>	H 36 L 45	EC605451/2	241	298				
	L 60	EC605601/2	268	332				
	H 48 L 60	EC606601/2	334	407				
 <p>fianco per colonna side panel for column</p>	fianco side panel							
	H 239,7x59,8x2	T94555	414	414				
	H 251,7x59,8x2	T94560	434	434				

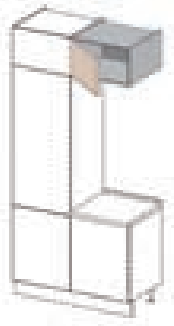

N.B.: il sistema a ponte può essere realizzato solo tra due colonne
 Note: the bridge system realized only between 2 columns

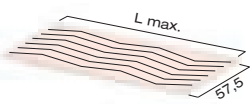
	COD.	FASCIA A K80	FASCIA B K80			
 <p>sopracolonna per sistema ponte 1 anta top column for bridge system 1 door</p>	H 36 L 45	EC601461/2	188	226		
	L 60	EC601611/2	207	250		
	2 ante L 90	EC601910	298	375		
	H 48 L 45	EC602461/2	233	276		
	L 60	EC602611/2	265	315		
	2 ante L 90	EC602910	362	449		
 <p>cappa aspirante integrata totale con luce led e comando remoto, 2 ante - L 90 portata 696 m³/h classe energetica A - L 120 portata 730 m³/h classe energetica B (depuratore fornito smontato) fully integrated extractor hood with bar led and remote control, 2 doors - W 90 air flow rate 696 m³/h energetic class A - W 120 air flow rate 730 m³/h energetic class B (purifier supplied unassembled)</p>	H 36 L 90	EPC00900	1.422	1.498		
	L 120	EPC01200	1.814	1.899		
	H 48 L 90	EPC01900	1.466	1.551		
	L 120	EPC02200	1.863	1.901		
 <p>pannello di finitura come anta sp.1,8 venature orizzontali finishing panel same as door th.1,8 horizontal grains</p>						
	L.max 240 impiallacciato al mq max.lenght 240 veneered per m ²	094520	287	287		

CAPPA PER SOPRACOLONNA





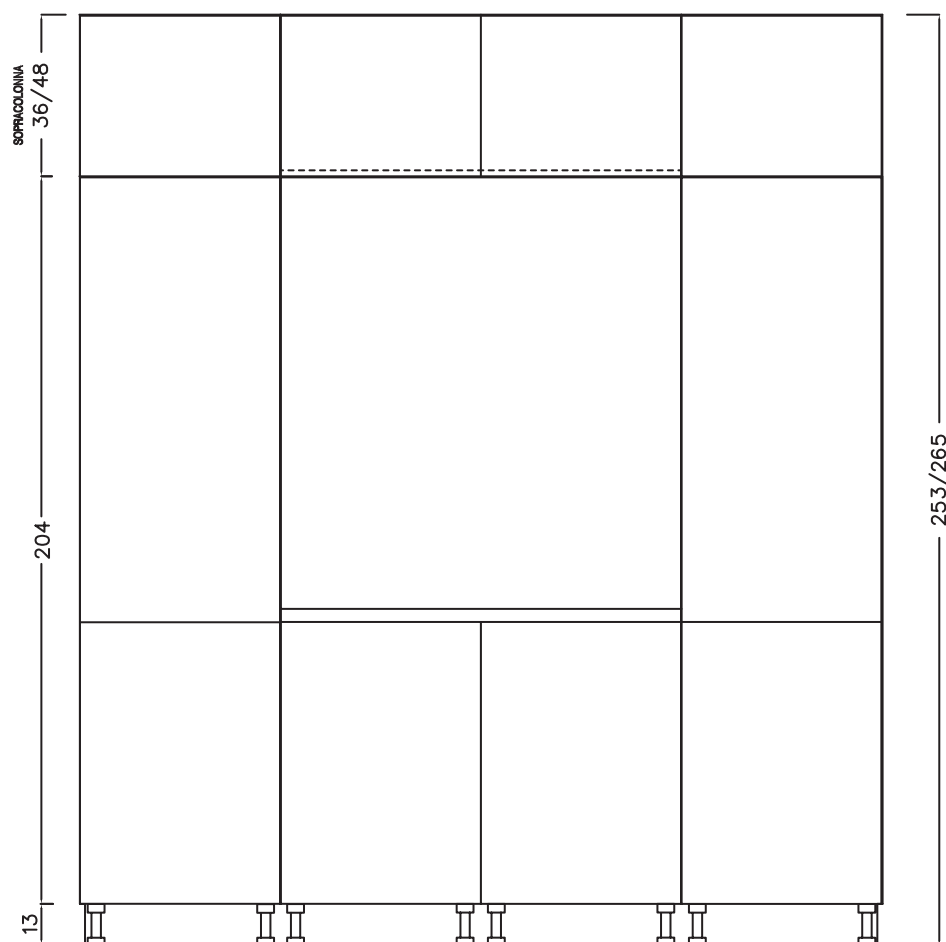
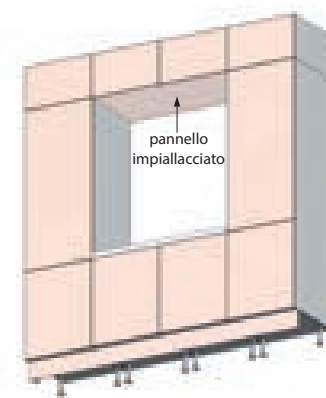

DETTAGLIO PANNELLO



253/265

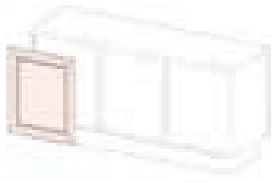











ANTE E FIANCHI DI FINITURA

FINISHING SIDES AND PANELS

	COD.	FASCIA A K80	FASCIA B K80				
 <p>ante di finitura posteriori per basi uso penisola-isola sp.2 rear finishing doors for base units used as peninsula-island Th.2</p>							
	BASE BASE UNIT						
	L 30 - 71,7x29,7	1K80430	115	165			
	L 40 - 71,7x39,7	1K80432	128	186			
	L 45 - 71,7x44,7	1K80434	131	190			
	L 60 - 71,7x59,7	1K80436	155	227			
L 65 - 71,7x64,7	1K80438	160	236				
 <p>maggiorazione per fianchi di struttura impiallacciati come anta (cadauno) surcharge for veneered carcass sides same finish as door (each)</p>							
	PENSILE WALL UNIT						
	36x31		+31	+31			
	48x31		+37	+37			
	60x31		+43	+43			
	72x31		+48	+48			
	96x31		+56	+56			
	BASE BASE UNIT						
	36x57,5		+49	+49			
	48x57,5		+61	+61			
	60x57,5		+74	+74			
	72x57,5		+78	+78			
	COLONNA COLUMN						
	132x31		+76	+76			
	204x31		+98	+98			
	228x31		+109	+109			
	96x57,5		+102	+102			
	132x57,5		+139	+139			
204x57,5		+212	+212				
228x57,5		+237	+237				
 <p>pannello di finitura impiallacciato come anta sp.2 N.B.: quantità minima fatturabile 0,5 mq finishing panel veneered same as door th.2 Note: minimum invoiceable quantity 0,5 m²</p>							
	venatura orizzontale prezzo al mq horizontal grain prices per m ²	0945252	287	287			
 <p>pannello di finitura impiallacciato come anta sp.2 N.B.: quantità minima fatturabile 0,5 mq finishing panel veneered same as door th.2 Note: minimum invoiceable quantity 0,5 m²</p>							
	venatura verticale prezzo al mq vertical grain prices per m ²	0945252V	287	287			



MENSOLE

SHELVES

	CODICE	€			CODICE	FASCIA A	FASCIA B
<p>mensola sp.3,8 in laminato L. max cm 400 laminated shelf th.3,8 max length 400 cm</p>  <p>finiture: finishes</p> <div style="display: flex; justify-content: space-around;"> <div style="text-align: center;">  <p>conchiglia (opz.8910) seashell</p> </div> <div style="text-align: center;">  <p>visone (opz.948M) mink</p> </div> </div> <div style="text-align: center; margin-top: 20px;">  <p>argilla (opz.9690) clay</p> </div> <p style="text-align: right; margin-top: 20px;">al ml per lm P 31</p> <p style="text-align: center;">magg. reggimensola a scomparsa surcharge fully integrated shelf bracket</p> <p style="text-align: right;">P 61</p>							
	091523	62					
	08610400	+12					
	091560	79					
<p>mensola soprapensile impiallacciata con schienale e cornice sagomata above-wall unit veneered shelf with back panel and shaped frame</p>  <p style="text-align: right; margin-top: 20px;">L 60 L 90 L 120</p>							
	E8730600	190					
	E8730900	257					
	E8731200	347					
<p>mensola soprapensile impiallacciata con cornice sagomata above-wall unit veneered shelf with shaped frame</p>  <p style="text-align: right; margin-top: 20px;">L 60 L 90 L 120</p>							
	E8750600	156					
	E8750900	206					
	E8751200	278					
<p>mensola sp.3,8 impiallacciata colore come anta L. max cm 250</p> <p style="color: red;">n.b.: quantità minima fatturabile 0,5 ml</p>  <p>veneered shelf th.3,8 colour matching with door max: length 250 cm</p> <p style="color: red;">note: minimum invoiceable quantity 0,5 lm</p> <div style="display: flex; justify-content: space-around; margin-top: 20px;"> <div style="text-align: center;">  <p>frassino bianco camelia (opz.2475) camelia white ash</p> </div> <div style="text-align: center;">  <p>frassino grigio reale (opz.2477) royal grey ash</p> </div> </div> <div style="display: flex; justify-content: space-around; margin-top: 20px;"> <div style="text-align: center;">  <p>frassino argilla decapè (opz.2476) clay pickled ash</p> </div> <div style="text-align: center;">  <p>frassino tinto noce (opz.2478) walnut stained ash</p> </div> </div> <div style="text-align: center; margin-top: 20px;">  <p>frassino verde cinabro (opz.2479) cinabro green ash</p> </div> <p style="text-align: right; margin-top: 20px;">al ml per lm P 31</p> <p style="text-align: center;">magg. reggimensola a scomparsa surcharge fully integrated shelf bracket</p> <p style="text-align: right;">P 61</p>							
	091723	167					
	08610400	+12					
	091729	276					

MENSOLE - CORNICI

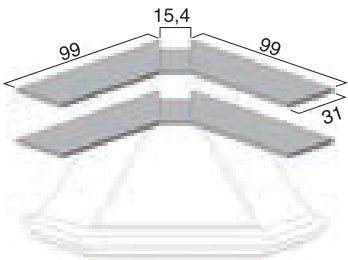
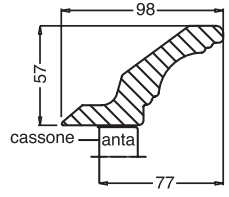
SHELVES - CORNICES

	CODICE	€			CODICE	€	
<p>mensole prof.31 per cappa caminetto ad angolo shelves D 31 for corner chimney hood</p>  <p>Laminato Laminate nr.2 da 99 taglio 45° dx 2x99 cm 45° cut RH nr.2 da 99 taglio 45° sx 2x99 cm 45° cut LH nr.2 da 15,4 taglio dritto 2x15,4 cm straight cut</p> <p>Impiallacciata Veneered nr.2 da 99 taglio 45° dx 2x99 cm 45° cut RH nr.2 da 99 taglio 45° sx 2x99 cm 45° cut LH nr.2 da 15,4 taglio dritto 2x15,4 cm straight cut</p>	091523	130			<p>cornice cappello (per motivi tecnici le cornici in angoli fuori squadra non si possono inviare tagliate) top cornice (for technical reasons, cornices for out-of-plumb corners cannot be shipped already cut)</p>   <p>al ml per lm</p>	093010	102
		091523	130				
		091523	22				
		091723	332				
		091723	332				
		091723	52				

SCHIENALE DOGATO IMPIALLACCIATO COLORE COME ANTA

VENEERED BACK PANEL WITH STRIPES, SAME COLOUR AS DOOR

	<p>Particolare schienale dogato Detail of the stripes back</p> <p>N.B.: quantità minima fatturabile 0,5 mq Note: minimum invoiceable quantity 0,5 m²</p>	

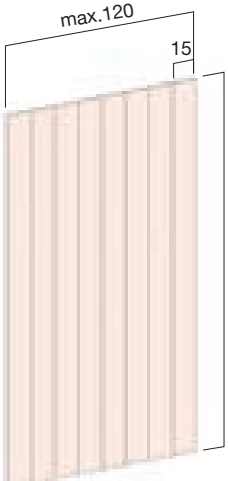
	CODICE	€		CODICE	€
<p>Schienale dogato sp. 18 mm. colore come anta striped back panel th. 18 mm same colour as door</p>  <p>al mq per m²</p>	094341	264			

BASAMENTO E PIEDE PENISOLA



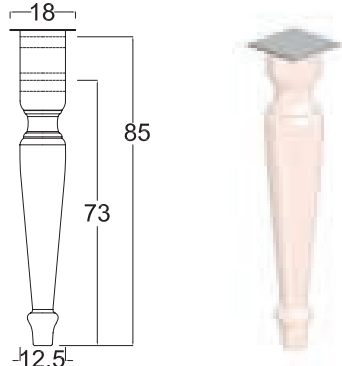



BASEMENT AND FOOT PENINSULA

	CODICE	€			CODICE	€	
<p>basamento in ferro finitura nero o titanio H 13 P 40,4 al ml n.b.: quantità minima fatturabile 1 ml iron basament in black or titan finishing H 13 D 40,4 per lm note: minimum invoiceable quantity 1 lm</p>  <p>L max 259,4 max.lenght 259,4</p> <p>nero black titanio titan</p>	T92540	288					
	T92541	288					
<p>piede penisola "Bens" in legno colore come anta wooden foot "Bens" for peninsula, same colour as door</p> 	08800308	258					
	08800314	274					

ELEMENTI A GIORNO IMPIALLACCIATI COLORE COME ANTA

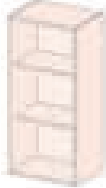



VENEERED OPEN UNITS SAME COLOUR AS DOOR

N.B.: i ripiani vetro sono dotati di profilo led e non si effettuano fuori misura in larghezza
 Note: the glass shelves come equipped with led profiles and custom-sized length unavailable

		COD.	€ K80					
	pensile H 24 P 31 a giorno 1 vano attaccaglie a scomparsa open wall unit H 24 D 31 1 compartment concealed hangers	L 45	E7901450	206				
		L 60	E7901600	224				
		L 90	E7901900	265				
	pensile H 36 P 31 a giorno 1 vano attaccaglie a scomparsa open wall unit H 36 D 31 1 compartment concealed hangers	L 45	E7902450	228				
		L 60	E7902600	243				
		L 90	E7902900	283				
	pensile H 72 P 31 a giorno 3 vani e 2 ripiani attaccaglie a scomparsa open wall unit H 72 D 31 3 compartments and 2 shelves concealed hangers	ripiani impiallacciati L 30	E7904300I	280				
			L 45	E7904450I	302			
			L 60	E7904600I	321			
		ripiani vetro L 30	E7904300	438				
			L 45	E7904450	494			
			L 60	E7904600	551			
	pensile H 96 P 31 a giorno 3 vani e 2 ripiani attaccaglie a scomparsa open wall unit H 96 D 31 3 compartments and 2 shelves concealed hangers	ripiani impiallacciati L 30	E7905300I	336				
			L 45	E7905450I	355			
			L 60	E7905600I	373			
		ripiani vetro L 30	E7905300	486				
			L 45	E7905450	544			
			L 60	E7905600	608			
	base H 85 P 38 a giorno 3 vani e 2 ripiani open base unit H 85 D 38 3 compartments and 2 shelves	ripiani impiallacciati L 30	E7916300I	320				
			L 45	E7916450I	346			
			L 60	E7916600I	373			
		ripiani vetro L 30	E7916300	480				
			L 45	E7916450	540			
			L 60	E7916600	603			
	colonna H 145 P 38 a giorno 4 vani e 3 ripiani open column H 145 D 38 4 compartments and 3 shelves	ripiani impiallacciati L 30	E7922300I	506				
			L 45	E7922450I	533			
			L 60	E7922600I	559			
		ripiani vetro L 30	E7922300	665				
			L 45	E7922450	766			
			L 60	E7922600	828			
	colonna H 217 P 38 a giorno 6 vani e 5 ripiani open column H 217 D 38 6 compartments and 5 shelves	ripiani impiallacciati L 30	E7924300I	701				
			L 45	E7924450I	728			
			L 60	E7924600I	755			
		ripiani vetro L 30	E7924300	949				
			L 45	E7924450	1.075			
			L 60	E7924600	1.196			

TERMINALI A GIORNO IMPIALLACCIATI COLORE COME ANTA

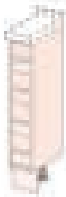

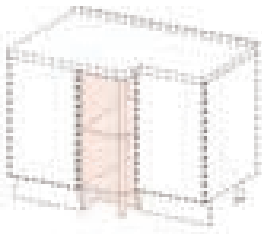



VENEERED OPEN END UNITS SAME COLOUR AS DOOR

	COD.	€ K80				
 <p>pensile terminale a giorno H 72 P 31 open end wall unit H 72 D 31</p>	L 31	E2573311/2	607			
 <p>pensile terminale a giorno H 96 P 31 open end wall unit H 96 D 31</p>	L 31	E2574311/2	762			
 <p>base portabottiglie H 85 P 31 bottles rack base unit H 85 D 31</p>	L 15	E4631150	705			
 <p>base terminale a giorno H 85 P 57,5 open end base unit H 85 D 57,5</p>	L 31	E4631311/2	762			
 <p>base terminale a giorno H 85 P 57,5 con elemento portabottiglie open end base unit H 85 D 57,5 with bottles rack unit</p>	L 44,2	E4631441/2	1.451			
 <p>base di raccordo a giorno H 85 P 57,5 open junction base unit H 85 D 57,5</p>	L 30	E4631301/2	899			

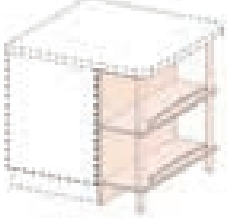
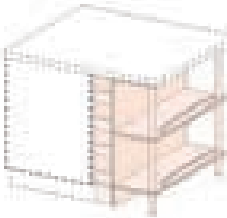
ELEMENTI
TERMINALI A GIORNO
UNITS OPEN END UNITS

TERMINALI A GIORNO IMPIALLACCIATI COLORE COME ANTA

VENEERED OPEN END UNITS SAME COLOUR AS DOOR

	COD.	€ K80				
 <p>isola terminale a giorno H 85 P 31 open end base unit H 85 D 31</p>						
	L 57,5	E4632300	762			
	L 88,5	E4632310	868			
	L 115	E4633310	1.569			
 <p>isola terminale a giorno H 85 P 44,2 con 2 elementi portabottiglie open end base unit H 85 D 44,2 with 2 bottles rack units</p>						
	L 88,5	E4632440	2.035			
 <p>colonna portabottiglie H 145 P 31 bottles rack column H 145 D 31</p>						
	L 15	E6378010	1.325			
 <p>colonna terminale a giorno H 145 P 57,5 open end column H 145 D 57,5</p>						
	L 31	E6378011/2	1.122			
 <p>colonna terminale a giorno H 145 P 57,5 con elemento portabottiglie open end column H 145 D 57,5 with bottles rack unit</p>						
	L 44,2	E6378141/2	2.190			
 <p>colonna terminale a giorno H 217 P 57,5 open end column H 217 D 57,5</p>						
	L 31	E6378211/2	1.451			
 <p>colonna terminale a giorno H 241 P 57,5 open end column H 241 D 57,5</p>						
	L 31	E6378311/2	1.638			

ISOLA IN LEGNO

WOOD ISLAND



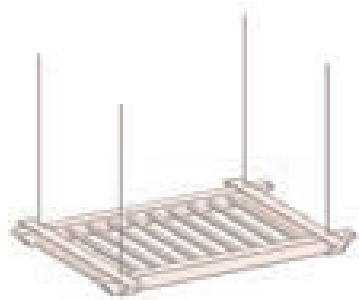

	COD.	€ K80				
<p>isola in legno con 3 cassetti e ripiano grigliato colore come anta wood island with 3 drawers and wire shelf same colour as door</p>  <p style="text-align: right;">L 180 H 89 P 90</p>	E4951100	1.472				
<p>elemento sopra isola in legno colore come anta wood over island unit same colour as door</p>  <p style="text-align: right;">L 120 H 6 P 90</p>	08605970	808				

ELEMENTI DI
COMPLEMENTO
ACCESSORY ELEMENTS

SOTTOPENSILI IN LEGNO COLORE COME ANTA

WOOD UNDERMOUNT WALL UNITS SAME COLOUR AS DOOR



	COD.	€ K80				
 <p>sottopensile in legno con mensola H 17 P 27 colore come anta wood undermount wall unit with shelf H 17 D 27 same colour as door</p>	L 45	08603412	130			
	L 60	08603414	136			
	L 90	08603416	148			
 <p>sottopensile in legno portabottiglie H 17 P 27 colore come anta wood undermount wall unit with bottle holder H 17 D 27 same colour as door</p>	L 45	08603422	142			
	L 60	08603424	148			
	L 90	08603426	160			
 <p>sottopensile in legno sagomato con mensola e ganci H 24,8 P 31 colore come anta shaped wood undermount wall unit with shelf and hooks H 24,8 D 31 same colour as door</p>	L 45	08603402	123			
	L 60	08603404	130			
	L 90	08603406	136			





LIVING

Spazi coordinati per avere un solo ambiente per cucinare, ricevere gli amici, pranzare e rilassarsi è una soluzione al desiderio di vivere la casa più liberamente, secondo stili di vita contemporanei, integrando cucina e living all'insegna di un nuovo linguaggio progettuale.

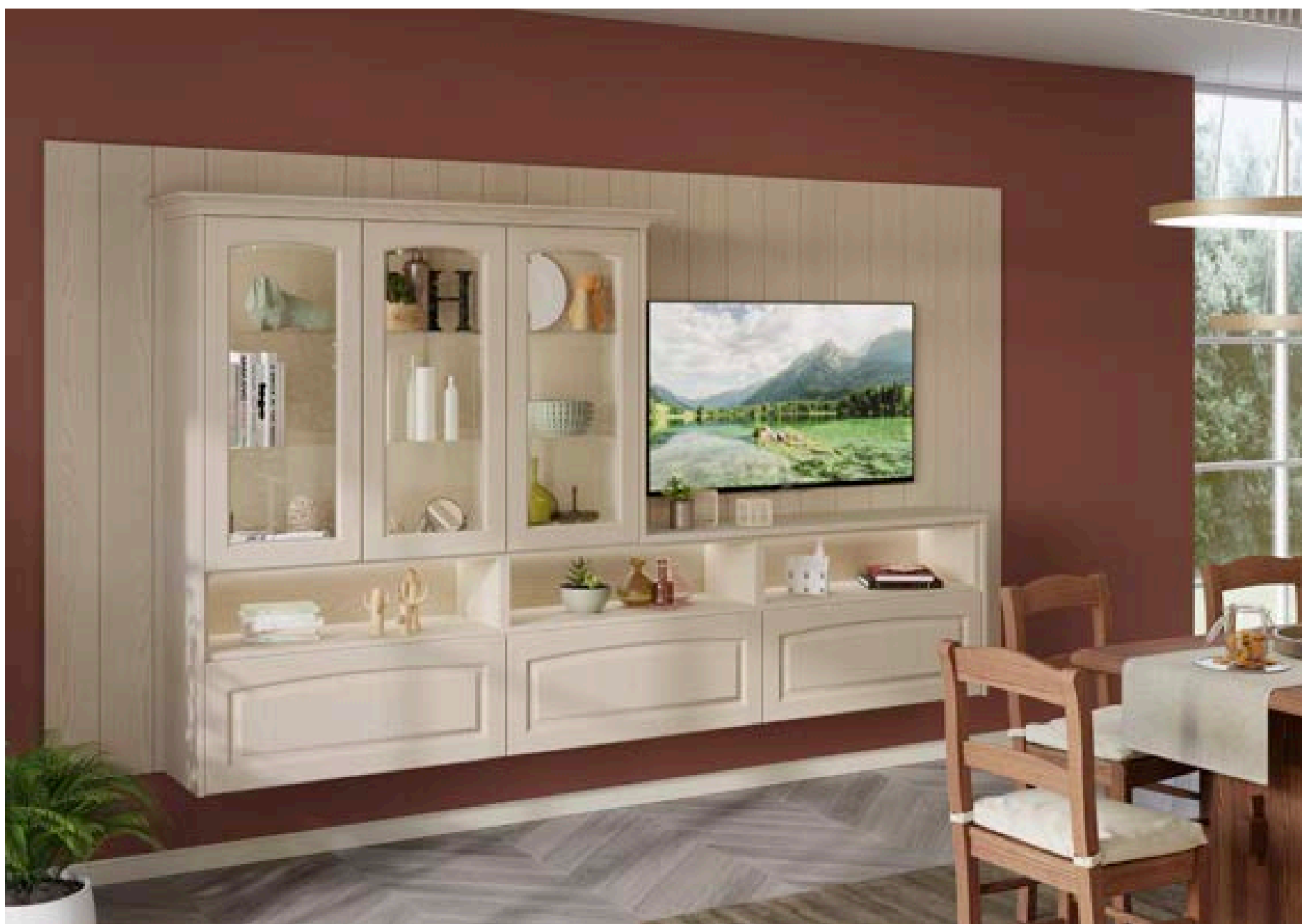
Coordinated spaces that create a single environment in which to cook, receive friends and relax is a solution that allows you to experience the home more freely.

In line with contemporary lifestyles, this solution integrates the kitchen and living area to create a new design language



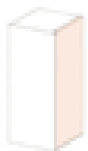





Per la modulistica completa dei pensili consultare la sezione "Pensili" For complete modularity of wall units see "wall units units section"		COD.	FASCIA A K80	FASCIA B K80				
 <p>pensile H 36 apertura a vasistas con push-pull (opz.996) wall unit H 36 flap door with push-pull opening (opt.996)</p>	L 60	E2106600	215	253				
	L 90	E2106900	304	353				
 <p>pensile H 48 apertura a vasistas con push-pull (opz.996) wall unit H 48 flap door with push-pull opening (opt.996)</p>	L 60	E2123600	302	346				
	L 90	E2123900	341	399				
 <p>pensile H 36 anta vetro apertura a vasistas con push-pull (opz.996) wall unit H 36 glass door flap door with push-pull opening (opt.996)</p>	L 60	E1106600	273	337				
	L 90	E1106900	381	460				
 <p>pensile H 48 anta vetro apertura a vasistas con push-pull (opz.996) wall unit H 48 glass door flap door with push-pull opening (opt.996)</p>	L 60	E1126600	357	428				
	L 90	E1126900	424	515				
 <p>mensola in appoggio per pensile finitura come anta support shelf for wall unit same finish as door</p>								
		P 33,2 sp.2 al ml D 33,2 th.2 per lm L max 240 impiallacciata max.lenght 240 veneered	TIL202	96	96			
 <p>maggiorazione per fianchi di struttura come anta (cadauno) surcharge for carcass sides same finish as door (each)</p>								
		PENSILE						
		WALL UNIT						
	36x31		+31	+31				
	48x31		+37	+37				

BASI LIVING con piedi H 2,5

H 20,5 - 26,5 - 50,5 P 50,2





LIVING AREA BASE UNITS with feet H 2,5

LE BASI NON SONO COMPRENSIVE DI TOP THE BASE UNITS DO NOT INCLUDE THE TOPS		COD.	FASCIA A K80	FASCIA B K80			
 <p>base H 20,5 1 cassetto base unit H 20,5 1 drawer</p>	L 45	EBL03450	157	172			
	L 60	EBL03600	171	189			
	L 90	EBL03900	220	246			
 <p>base H 38,5 1 anta base unit H 38,5 1 door</p>	L 45	EBL21451/2	174	211			
	L 60	EBL21601/2	192	235			
 <p>base H 38,5 2 ante base unit H 38,5 2 doors</p>	L 90	EBL21900	302	377			
	L 120	EBL22200	348	434			
 <p>base H 38,5 1 cestone base unit H 38,5 1 deep drawer</p>	L 45	EBL25450	233	271			
	L 60	EBL25600	265	308			
	L 90	EBL25900	300	353			
 <p>base H 38,5 2 cassetti H 18 base unit H 38,5 2 drawers H 18</p>	L 45	EBL23450	266	297			
	L 60	EBL23600	288	324			
	L 90	EBL23900	358	411			
 <p>base H 50,5 1 anta base unit H 50,5 1 door</p>	L 45	EBL31451/2	188	231			
	L 60	EBL31601/2	210	259			

BASI LIVING con piedi H 2,5

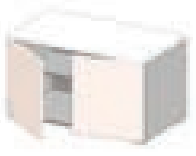
H 50,5 - 62,5 P 50,2

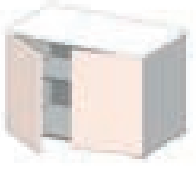





LIVING AREA BASE UNITS with feet H 2,5

LE BASI NON SONO COMPRENSIVE DI TOP THE BASE UNITS DO NOT INCLUDE THE TOPS		COD.	FASCIA A K80	FASCIA B K80					
 <p>base H 50,5 2 ante base unit H 50,5 2 doors</p>	L 90	EBL31900	328	413					
	L 120	EBL32200	391	488					
 <p>base H 50,5 1 cestone base unit H 50,5 1 deep drawer</p>	L 45	EBL35450	233	275					
	L 60	EBL35600	267	316					
	L 90	EBL35900	309	371					
 <p>base H 62,5 1 anta base unit H 62,5 1 door</p>	L 45	EBL41451/2	205	252					
	L 60	EBL41601/2	229	284					
 <p>base H 62,5 2 ante base unit H 62,5 2 doors</p>	L 90	EBL41900	353	447					
	<p>top living finitura come anta worktop living same finish as door</p> 								
		<p>P 50,2 sp.2 al ml D 50,2 th.2 per lm L max 240 impiallacciato max.lenght 240 veneered</p>	TIL2055	145	145				
 <p>maggiorazione per fianchi di struttura come anta (cadauno) surcharge for carcass sides same finish as door (each)</p>	BASI BASE UNITS								
	18x48			+49	+49				
	24x48			+49	+49				
	36x48			+49	+49				
	48x48			+61	+61				
	60x48			+74	+74				

BASI SOSPENSE LIVING con Attaccaglie e Barre Fissaggio a parete

H 36 - 48 P 50,2





HANGING LIVING BASE UNITS with Hangers and Rods for wall mounting

LE BASI NON SONO COMPRENSIVE DI TOP THE BASE UNITS DO NOT INCLUDE THE TOPS		COD.	FASCIA A K80	FASCIA B K80			
 <p>base H 36 1 anta base unit H 36 1 door</p>	L 45	EBL71451/2	193	231			
	L 60	EBL71601/2	212	254			
 <p>base H 36 2 ante base unit H 36 2 doors</p>	L 90	EBL71900	311	386			
	L 120	EBL72200	355	440			
 <p>base H 36 1 cestone base H 36 1 deep drawer</p>	L 45	EBL75450	253	290			
	L 60	EBL75600	285	327			
	L 90	EBL75900	320	373			
 <p>base H 48 1 anta base unit H 48 1 door</p>	L 45	EBL81451/2	218	261			
	L 60	EBL81601/2	239	288			
 <p>base H 48 2 ante base unit H 48 2 doors</p>	L 90	EBL81900	355	440			
	L 120	EBL82200	418	516			
 <p>base H 48 1 cestone base unit H 48 1 deep drawer</p>	L 45	EBL85450	238	281			
	L 60	EBL85600	272	321			
	L 90	EBL85900	315	377			

BASI LIVING CON ZOCCOLO

H 31 - 49 P 59,7

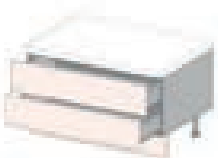

LIVING AREA BASE UNITS WITH PLINTH

LE BASI NON SONO COMPRENSIVE DI TOP THE BASE UNITS DO NOT INCLUDE THE TOPS		COD.	FASCIA A K80	FASCIA B K80				
 <p>base H 31 1 cassetto H 18 base unit H 31 1 drawer H 18</p>	L 45	E4023450	156	172				
	L 60	E4023600	175	193				
	L 90	E4023900	224	250				
 <p>base H 49 1 anta H 36 base unit H 49 1 door H 36</p>	L 45	E4026451/2	163	201				
	L 60	E4026601/2	184	226				
 <p>base H 49 2 ante H 36 base unit H 49 2 doors H 36</p>	L 90	E4026900	309	385				
	L 120	E4027200	360	445				
 <p>base H 49 1 cestone H 36 base unit H 49 1 deep drawer H 36</p>	L 45	E4204450	212	249				
	L 60	E4204600	235	278				
	L 90	E4204900	292	345				
 <p>base H 49 2 cassetti H 18 base unit H 49 2 drawers H 18</p>	L 45	E4204460	245	276				
	L 60	E4204610	272	309				
	L 90	E4204910	345	397				

BASI LIVING CON ZOCCOLO

H 61 P 59,7

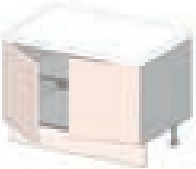
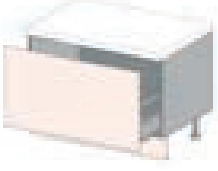
LIVING AREA BASE UNITS WITH PLINTH

LE BASI NON SONO COMPRENSIVE DI TOP THE BASE UNITS DO NOT INCLUDE THE TOPS		COD.	FASCIA A K80	FASCIA B K80			
 <p>base H 61 1 anta H 48 base unit H 61 1 door H 48</p>	L 45	E4028451/2	191	234			
	L 60	E4028601/2	211	260			
 <p>base H 61 2 ante H 48 base unit H 61 2 doors H 48</p>	L 90	E4028900	337	422			
	L 120	E4029200	403	501			
 <p>base H 61 1 cestone H 48 base unit H 61 1 deep drawer H 48</p>	L 45	E4205450	227	270			
	L 60	E4205600	253	302			
	L 90	E4205900	315	377			
 <p>top living finitura come anta worktop living same finish as door</p>	<p>P 59,7 sp.2 al ml D 59,7 th.2 per lm</p> <p>L max 240 impiallacciato max.lenght 240 veneered</p>		TIL206	171	171		
 <p>maggiorazione per fianchi di struttura come anta (cadauno) surcharge for carcass sides same finish as door (each)</p>	<p>BASI BASE UNITS</p>						
	18x57,5			+49	+49		
	24x57,5			+49	+49		
	36x57,5			+49	+49		
	48x57,5			+61	+61		

LIVING KGR1



ANTA
door

FRASSINO
ARGILLA DECAPÈ
clay pickled ash

ELEMENTI A GIORNO
open units

FRASSINO
ARGILLA DECAPÈ
clay pickled ash

STRUTTURA
carcass

JUTA EFFETTO TELA
jute melamine-coated
canvas effect



LIVING KGR1

NR. ELEMENTI	DESCRIZIONE	CODICE	€ cad.
3	Pensile L 45 H 96 P 33,2 anta e ripiano vetro, apertura push-pull	E1020451/2	315
3	Pensile L 90 H 36 P 33,2 vasistas, apertura push-pull	E2106900	304
3	Pensile L 90 H 24 P 31 a giorno impiallacciato come anta	E7901900	265
3	Profilo led mini noor dualcolor L 863	08618335	92
1	Alimentatore Mec Driver	08618002	43
1	Distributor	08618025	8
1	Cavo alimentazione Mec Driver	08618021	6
1	Top L 135,1 H 2 P 33,2 impiallacciato come anta	al ml TIL202	96
1	Fianco H 156+96+60 SP.2 P 33,2 impiallacciato come anta	al ml TIL202F	96
1	Cornice cappello L 224,6	al ml 093010	102
5	Asta appendipensili ml 2	08610501	9
	senza schienale	TOTALE	3.689
1	Schienale dogato L 330 H 180 SP.1,8 impiallacciato come anta	al mq 094341	264
	con schienale	TOTALE	5.257
No. of ELEMENTS	DESCRIPTION	CODE	€ each
3	Wall unit W 45 H 96 D 33,2 with glass door and shelf, push-pull opening	E1020451/2	315
3	Wall unit W 90 H 36 D 33,2 flap door with push-pull opening	E2106900	304
3	Veneered open wall unit W 90 H 24 D 31 same as door	E7901900	265
3	Mini noor lead profile dualcolor W 863	08618335	92
1	Power supply module Mec Driver	08618002	43
1	Distributor	08618025	8
1	Power cable Mec Driver	08618021	6
1	Veneered worktop W 135,1 H 2 D 33,2 same colour as door	per lm TIL202	96
1	Veneered side H 156+96+60 TH.2 D 33,2 same as door	per lm TIL202F	96
1	Top frame W 224,6	per lm 093010	102
5	Wall unit fixing strip lm 2	08610501	9
	with out back panel	TOTAL	3.689
1	Veneered striped back panel W 330 H 180 TH.1,8 same as door	per m ² 094341	264
	with back panel	TOTAL	5.257

LIVING KGR2



ANTA
door



ELEMENTI TRASFORMABILI
GENIUS-K
transformable elements
genius-k



STRUTTURA
carcass

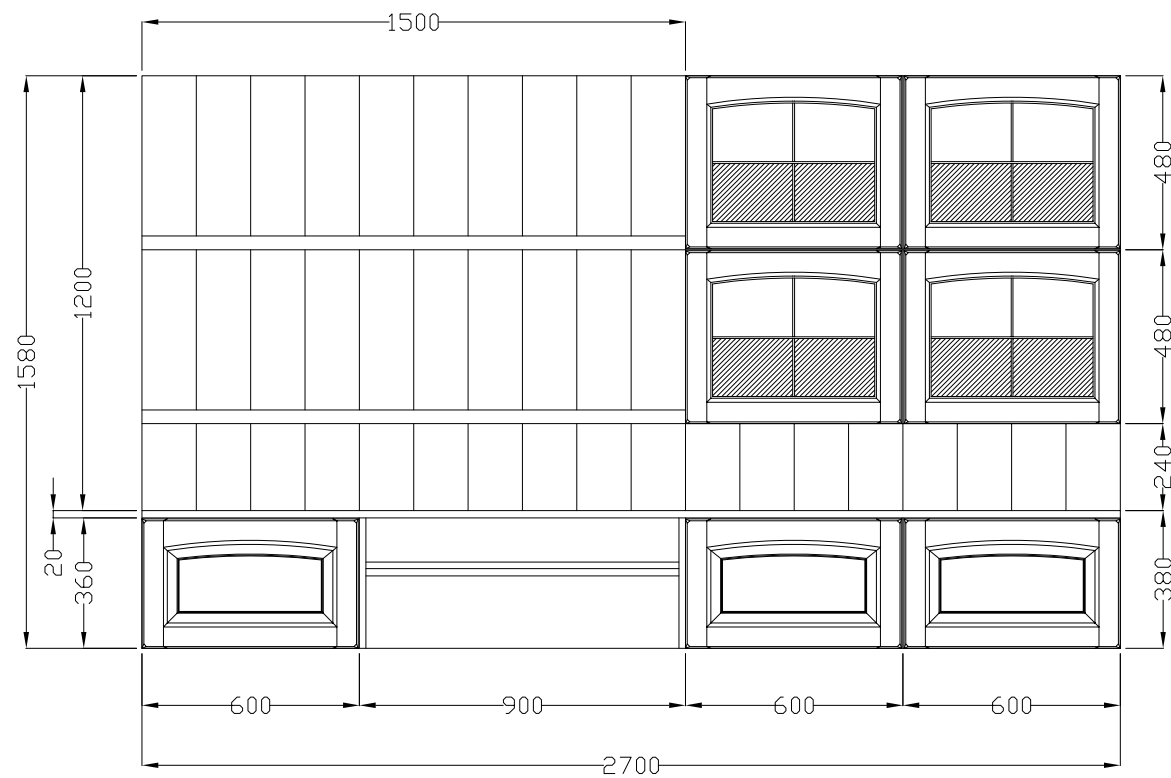
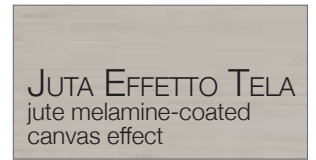

LIVING KGR2

NR. ELEMENTI	DESCRIZIONE	CODICE	€ cad.
2	Pensile L 60 H 48 P 33,2 anta e ripiano vetro, 1 fianco come anta	E1040601/2	307
2	Pensile L 60 H 48 P 33,2 anta e ripiano vetro	E1040601/2	270
4	Faretto Sunrise 58	08618081	24
2	Base living sospesa L 60 H 36 P 50,2 cestone, fianco come anta	EBL75600	334
1	Base living sospesa L 60 H 36 P 50,2 cestone	EBL75600	285
1	Base SKIP-S L 90 H 36 P 48	EBL27209	1.137
1	Top living L 150+120 P 50,2 SP. 2 impiallacciato come anta	al ml TIL2055	145
2	Mensola L 150 H 3,8 P 31 impiallacciato come anta	al ml 091723	167
4	Reggimensola a scomparsa	08610400	6
2	Profilo led mini noor dualcolor L 146	08618285	130
1	Alimentatore Mec Driver	08618003	72
1	Distributore	08618025	8
1	Cavo alimentazione Mec Driver	08618021	6
2	Asta appendipensili ml 2	08610501	9
senza schienale			TOTALE 4.621
1	Schienale dogato L 150 H 120 SP.2 impiallacciato come anta	al mq 094341	264
1	Schienale dogato L 120 H 24 SP.2 impiallacciato come anta	al mq 094341	264
con schienale			TOTALE 5.229
No. of ELEMENTS	DESCRIPTION	CODE	€ each
2	Wall unit W 60 H 48 D 33,2 with glass door and shelf, side same as door	E1040601/2	307
2	Wall unit W 60 H 48 D 33,2 with glass door and shelf	E1040601/2	270
4	Sunrise 58 spotlight	08618081	24
2	Hanging living base unit W 60 H 36 D 50,2 deep drawer, side same as door	EBL75600	334
1	Hanging living base unit W 60 H 36 D 50,2 deep drawer	EBL75600	285
1	SKIP-S base unit W 90 H 36 D 48	EBL27209	1.137
1	Veneered living worktop W 150+120 D 50,2 TH.2 same colour as door	per lm TIL2055	145
2	Veneered shelf H 150 H 3,8 D 31 same colour as door	per lm 091723	167
4	Fully integrated shelf bracket	08610400	6
2	Mini noor lead profile dualcolor W 146	08618285	130
1	Power supply module Mec Driver	08618003	72
1	Distributor	08618025	8
1	Power cable Mec Driver	08618021	6
2	Wall unit fixing strip lm 2	08610501	9
with out back panel			TOTAL 4.621
1	Veneered striped back panel W 150 H 120 TH.2 same colour as door	per m ² 094341	264
1	Veneered striped back panel W 120 H 24 TH.2 same colour as door	per m ² 094341	264
with back panel			TOTAL 5.229

LIVING KGR3



ANTA
door

FRASSINO
GRIGIO REALE
royal grey ash

STRUTTURA
carcass

GRIGIO EFFETTO TELA
grey melamine-coated
canvas effect

LIVING KGR3

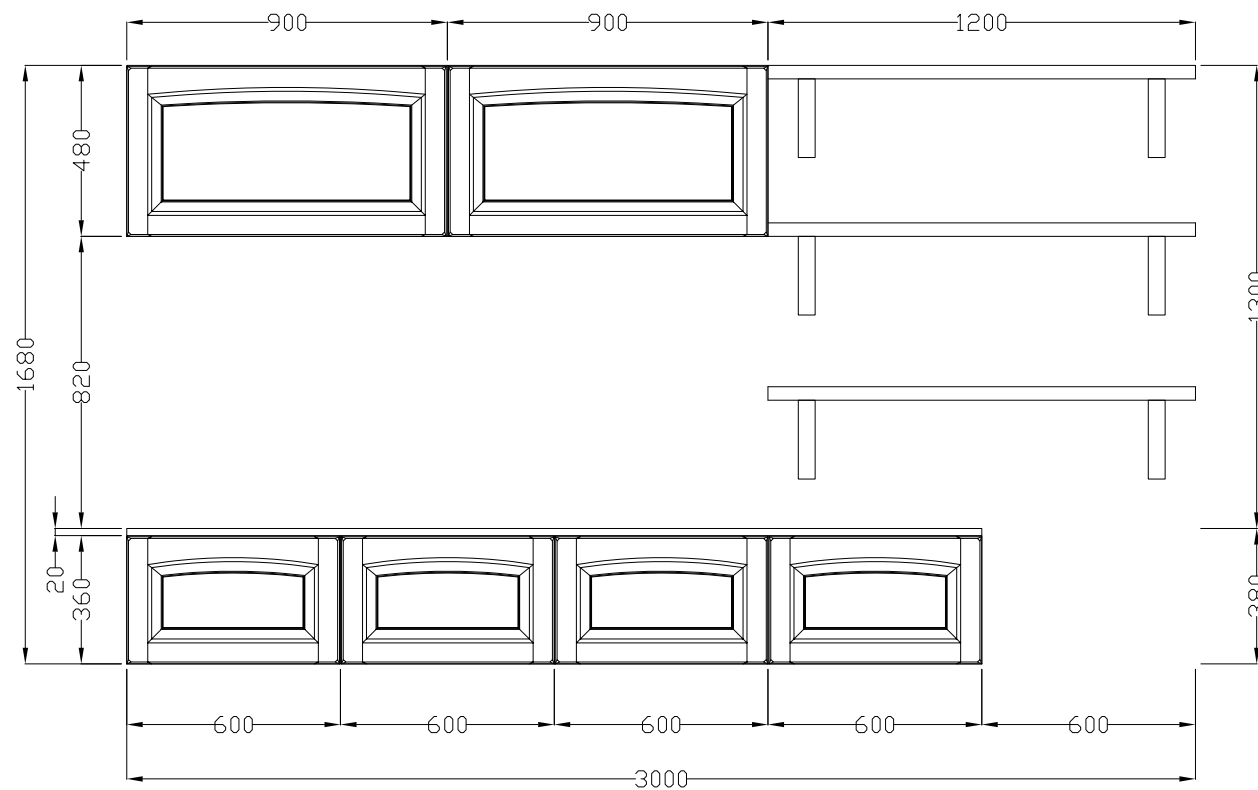

NR. ELEMENTI	DESCRIZIONE	CODICE	€ cad.
2	Pensile L 90 H 48 P 33,2 apertura tip-on, fianco come anta	E212091T	296
2	Base living sospesa L 60 H 36 P 50,2 cestone, fianco come anta	EBL25600	314
2	Base living sospesa L 60 H 36 P 50,2 cestone	EBL25600	265
1	Top living L 240 P 50,2 SP. 2 impiallacciato come anta	al ml TIL2055	145
3	Mensola L 120 P 31 SP. 3,8 impiallacciato come anta	al ml 091723	167
6	Reggimensola Polygon grigio selce	08610452G	78
3	Luce Kendo dualcolor L 86	08618233	85
1	Alimentatore Mec Driver	08618002	43
1	Distributore	08618025	8
1	Cavo alimentazione Mec Driver	08618021	6
1	Asta appendipensili ml 2	08610501	9
TOTALE			3.488

No. of ELEMENTS	DESCRIPTION	CODE	€ each
2	Wall unit W 90 H 48 D 33,2 tip-on opening side same as door	E212091T	296
2	Hanging living base unit W 60 H 36 D 50,2 deep drawer, side same as door	EBL25600	314
2	Hanging living base unit W 60 H 36 D 50,2 deep drawer	EBL25600	265
1	Veneered living worktop W 240 D 50,2 TH.2 same colour as door	per lm TIL2055	145
3	Veneered shelf H 120 D 31 TH.3,8 same colour as door	per lm 091723	167
6	Polygon shelf bracket flint grey	08610452G	78
3	Kendo light dualcolor W 86	08618233	85
1	Power supply module Mec Driver	08618002	43
1	Distributor	08618025	8
1	Power cable Mec Driver	08618021	6
1	Wall unit fixing strip lm 2	08610501	9
TOTAL			3.488

COMPOSIZIONE BASSA L 255

LOW COMPOSITION W 255



COMPOSIZIONE BASSA L 300

LOW COMPOSITION W 300



COMPOSIZIONE BASSA L 255

(IVA e contributo RAEE esclusi)

LOW COMPOSITION W 255

(VAT and WEEE fee excluded)

COMPONENTI COMPONENTS

GRACE

Colonna 60 H 219 frigo-freezer 315 classe F

60 cm column H 219 fridge-freezer 315 class "F"

Base 45 2 cassetti e cestone

45 cm base unit with 2 drawers and deep drawer

Base 60 forno statico inox con ventilazione tangenziale di raffreddamento

stainless steel static oven with orbital cooling ventilation 60 base unit

Piano cottura 60 4 gas inox con valvola di sicurezza

60 cm stainless steel hob with 4 gas burners with safety valve

Sottolavello 90

90 cm sink unit

Lavello ad incasso 86 x 50 1 vasca inox prelucidato

86x50 cm built-in sink with 1 stainless steel bowl

Pensile vetro 45 H 72

45 cm glass wall unit H 72

Cappa 60 aspirante estraibile H 63 1 motore

60 cm hood slide-out ducting H 63 1 motor

Scolapiatti 90 H 72

90 cm plate rack H 72

Top 195 P 61 in laminato H 4

195 cm laminate worktop D 61 H 4

Cornice cappello ml 3,71

3,71 lm top cornice

Asta appendipensili ml 2

2 lm wall unit fixing strip

Fascia A

€ 5.191

Band A

Fascia B

€ 5.768

Band B

(Elettrodomestici Beko)
(Beko appliances)

COMPOSIZIONE BASSA L 300

(IVA e contributo RAEE esclusi)

LOW COMPOSITION W 300

(VAT and WEEE fee excluded)

COMPONENTI COMPONENTS

GRACE

Colonna 60 H 219 frigo-freezer 315 classe F

60 cm column H 219 fridge-freezer 315 class "F"

Base 60 2 cassetti e cestone

60 cm base unit with 2 drawers and deep drawer

Base 60 forno statico inox con ventilazione tangenziale di raffreddamento

stainless steel static oven with orbital cooling ventilation 60 base unit

Piano cottura 60 4 gas inox con valvola di sicurezza

60 cm stainless steel hob with 4 gas burners with safety valve

Base 60

60 cm base unit

Sottolavello 60

60 cm sink unit

Lavello ad incasso 86 x 50 1 vasca inox prelucidato

86x50 cm built-in sink with 1 stainless steel bowl

Pensile 60 H 72

60 cm wall unit H 72

Cappa 60 aspirante estraibile H 63 1 motore

60 cm hood slide-out ducting H 63 1 motor

Pensile 60 H 72

60 cm wall unit H 72

Scolapiatti 60 H 72

60 cm plate rack H 72

Top 240 P 61 in laminato H 4

240 cm laminate worktop D 61 H 4

Cornice cappello ml 4,16

4,16 lm top cornice

Asta appendipensili ml 4

4 lm wall unit fixing strip

Fascia A

€ 5.518

Band A

Fascia B

€ 6.132

Band B

(Elettrodomestici Beko)
(Beko appliances)

COMPOSIZIONE ALTA L 300

HIGH COMPOSITION W 300



COMPOSIZIONE BASSA L 360

LOW COMPOSITION W 360



COMPOSIZIONE ALTA L 300

HIGH COMPOSITION W 300

(IVA e contributo RAEE esclusi)

(VAT and WEEE fee excluded)

COMPONENTI
COMPONENTS**GRACE****Colonna 60 H 243 frigo-freezer 315 classe F**

60 cm column H 243 fridge-freezer 315 class "F"

Base 60 2 cassetti e cestone

60 cm base unit with 2 drawers and deep drawer

Base 60 forno statico inox con ventilazione tangenziale di raffreddamento

stainless steel oven with orbital cooling ventilation 60 base unit

Piano cottura 60 4 gas inox con valvola di sicurezza

60 cm stainless steel hob with 4 gas burners with safety valve

Base 60

60 cm base unit

Sottolavello 60

60 cm sink unit

Lavello ad incasso 86 x 50 1 vasca inox prelucidato

86x50 cm built-in sink with 1 stainless steel bowl

Pensile 60 H 72

60 cm wall unit H 72

Cappa 60 aspirante estraibile H 63 1 motore

60 cm hood slide-out ducting H 63 1 motor

Pensile 60 H 96

60 cm wall unit H 96

Scolapiatti 60 H 96

60 cm plate rack H 96

Top 240 P 61 in laminato H 4

240 cm laminate worktop D 61 H 4

Mensola 120 P 31 sp. 3,8

120 cm shelf D 31 sp. 3,8

Cornice cappello ml 4,16

4,16 lm top cornice

Asta appendipensili ml 4

4 lm wall unit fixing strip

(Elettrodomestici Beko)

(Beko appliances)

Fascia A**€ 5.741**

Band A

Fascia B**€ 6.392**

Band B

COMPOSIZIONE BASSA L 360

LOW COMPOSITION W 360

(IVA e contributo RAEE esclusi)

(VAT and WEEE fee excluded)

COMPONENTI
COMPONENTS**GRACE****Colonna 60 H 219 frigo-freezer 315 classe F**

60 cm column H 219 fridge-freezer 315 class "F"

Colonna 60 H 111 con cestone, forno statico inox con ventilazione tangenziale di raffreddamento

60 column H.111 with deep drawer configured for stainless steel static oven with orbital cooling ventilation

Base 90 2 cassetti + cestone predisposto P.C.

90 cm base unit with 2 drawers + deep drawer configured for hob

Piano cottura 60 4 gas inox con valvola di sicurezza

60 cm stainless steel hob with 4 gas burners with safety valve

Base 60

60 cm base unit

Sottolavello 90

90 cm sink unit

Lavello ad incasso 86 x 50 1 vasca inox prelucidato

86x50 cm built-in sink with 1 stainless steel bowl

Pensile 60 H 72

60 cm wall unit H 72

Cappa 90 caminetto tipo "E"

90 chimney hood type "E"

Pensile 60 H 72

60 cm wall unit H 72

Scolapiatti 90 H 72

90 cm plate rack H 72

Top 240 P 61 in laminato H 4

240 cm laminate worktop D 61 H 4

Top 60 P 61 in laminato H 4

60 cm laminate worktop D 61 H 4

Mensola 90 P 31 SP 3,8

90 cm shelf D 31 SP 3,8

Cornice cappello ml 4,76

4,76 lm top cornice

Asta appendipensili ml 4

4 lm wall unit fixing strip

(Elettrodomestici Beko)

(Beko appliances)

Fascia A**€ 6.383**

Band A

Fascia B**€ 7.062**

Band B

Handwriting practice lines consisting of 25 horizontal dotted lines.

Handwriting practice lines consisting of 25 horizontal dotted lines.

