



**MAGGIORAZIONE  
SURCHARGE**

**+ 8%**

**DAL 23 GENNAIO 2023  
FROM JANUARY 23, 2023**

**AUREA classico**

listino 2021

# CONDIZIONI GENERALI DI VENDITA

## DECORRENZA

Il presente listino sostituisce ed annulla tutti i precedenti.

Non costituisce offerta e può essere modificato, con comunicazione scritta dell'AZIENDA al Cliente, in qualsiasi momento anche senza preavviso.

Le modificazioni o gli aggiornamenti avranno efficacia rispetto a tutti gli ordinativi pervenuti o trasmessi all'AZIENDA dopo la comunicazione scritta di cui sopra.

## PREZZI DI LISTINO E CONDIZIONI DI PAGAMENTO

I prezzi sono quotati al pubblico I.V.A. e contributo RAEE esclusi e si intendono franco fabbrica.

Decorso il termine contrattuale di pagamento l'AZIENDA è autorizzata alla emissione di tratte a saldo di ogni suo avere maggiorate degli interessi, spese e di ogni altro onere accessorio, previa comunicazione al Cliente. In caso di pagamento oltre i termini contrattuali, saranno addebitati gli interessi ai sensi del D.lgs. 231/2002, oltre al recupero di eventuali sconti espressamente concessi in ragione del termine di pagamento.

In caso di mancato pagamento nei tempi contrattuali l'AZIENDA potrà sospendere l'evasione degli ordini in corso previa comunicazione al Cliente.

## CONSEGNA

I termini di consegna vengono computati in giorni lavorativi con decorrenza dal perfezionamento del contratto di vendita, che comunque si intende perfezionato entro 8 giorni dall'invio dell'ordine o comunque entro 8 giorni dall'ultimo chiarimento (se richiesto) fornito dal Cliente. I termini di consegna saranno prorogati automaticamente in dipendenza di avvenimenti non imputabili all'AZIENDA o a cause di forza maggiore. Sono sempre ammesse consegne parziali.

## PRODOTTO

I dati tecnici relativi ai prodotti illustrati nel presente listino sono puramente indicativi come indicativi. L'AZIENDA si riserva la facoltà di apportare tutte le modifiche tecnico-costruttive migliorative del prodotto, senza obbligo di preavviso. La merce potrà tuttavia presentare caratteristiche parzialmente difformi da quelle indicate nel listino e nel catalogo, e comunque non risultare del tutto identica ai campioni che eventualmente fossero stati visionati in occasione della effettuazione dell'ordine, dovendosi riconoscere margini di tolleranza per quanto concerne i colori e le tonalità. La conformità al campione non deve intendersi in senso tassativo. Ciò vale anche per gli elettrodomestici o altri accessori impiegati a corredo delle cucine; questi potranno risultare esteticamente leggermente difformi in base alle marche utilizzate diverse da quelle da catalogo, salvo la sostanziale conformità delle caratteristiche e delle funzioni. Il Cliente potrà richiedere elementi specifici indicandone la marca sempre nell'ambito del ventaglio di offerte dell'AZIENDA non assume alcuna responsabilità circa la tenuta dei supporti che dipendesse da insufficienza della parete a cui venissero applicati gli stessi poiché la verifica dell'idoneità della parete dovrà essere effettuata dal cliente.

## CONSISTENZA FINITURE

Le finiture potrebbero subire nel tempo modificazioni di colore dovute all'esposizione alla luce, al calore, ai vapori e all'invecchiamento. È, pertanto, naturale che in caso di successivi completamenti, si potranno avere delle differenze di tonalità che comunque dovrebbero tendere ad attenuarsi nel tempo. Per i piani in marmo e granito, considerando che il taglio proviene da BLOCCHI NATURALI, non possiamo garantire l'uniformità del colore e della grana. Questi fattori non potranno costituire motivo di contestazione o di resa del prodotto.

## TRASPORTO

La merce non viaggia mai con mezzi dell'AZIENDA e, di conseguenza, nel momento in cui questa viene affidata al vettore, a prescindere da chi lo abbia incaricato, o caricata nel mezzo del cliente tutti i rischi passano al cliente stesso. Il Cliente, anche tramite suoi incaricati, ha l'obbligo di controllare l'integrità della merce all'arrivo ed, eventualmente, fare le dovute contestazioni scritte al Vettore. Qualora il danno rende inutilizzabile la merce è opportuno non ritirarla dandone conto nel Documento di Trasporto, diversamente con l'apposizione della firma da parte del Cliente, senza alcuna contestazione e/o rilievo si attesta la perfetta integrità e conformità della merce.

## INSTALLAZIONE E IMPIEGO

L'AZIENDA declina ogni responsabilità per l'errata o impropria installazione del prodotto fornito (mobili, piani di lavoro, elettrodomestici, impianti elettrici o idraulici ecc.) siano essi di sua fabbricazione o di terzi, sempre che non provveda essa stessa alle predette operazioni. L'acquirente non potrà in nessun caso richiedere il risarcimento dei danni eventualmente causati in occasione dell'installazione. L'AZIENDA si ritiene esonerata da qualsiasi responsabilità circa il funzionamento degli elettrodomestici e degli accessori fabbricati da terzi costruttori, per i quali venga fornito dal predetto fabbricante lo specifico libretto di uso e manutenzione; nel libretto si troverà indicato l'eventuale Ufficio Reclami o i Centri di Assistenza del terzo fabbricante. Per l'impropria e/o inadeguata manutenzione, nonché per l'improprio e/o inadeguato utilizzo dei prodotti venduti, l'AZIENDA rinvia ogni e qualsiasi responsabilità e/o onere al Cliente o all'Utilizzatore.

## RECLAMI ED AZIONI

I vizi e i difetti devono essere denunciati all'AZIENDA nei termini di legge. Anche nel caso di contestazione i pagamenti non potranno essere sospesi. La merce rimarrà di proprietà dell'AZIENDA sino al pagamento totale da parte del committente.

## GARANZIA

La garanzia sui prodotti venduti opererà per il tempo che, di volta in volta, le leggi vigenti nel Paese del Cliente stabiliranno come minimo a favore dell'acquirente.

## RESTITUZIONE DI MERCE

La restituzione delle merci vendute si accetta solo se espressamente autorizzata dalla LUBE INDUSTRIES s.r.l.. Verranno concordate modalità di reintegro e di accredito, solo qualora la restituzione sia dovuta a fatti imputabili alla LUBE INDUSTRIES s.r.l.. La merce restituita dovrà essere consegnata in perfette condizioni e adeguatamente imballata. La merce da sostituire dovrà essere restituita senza ritardo dal commerciante alla fabbricante. Nel caso in cui detta merce sia restituita fino a sei mesi dalla sostituzione la fabbricante accrediterà al commerciante il cento per cento del valore della stessa; tra i sei e i nove mesi sarà accreditato al commerciante il settanta per cento del valore della merce; qualora la restituzione avvenga tra i nove ed i dodici mesi dalla sostituzione sarà accreditato al commerciante il cinquanta per cento del valore della merce; qualora la restituzione non sia compiuta nei dodici mesi non vi sarà accreditato nessun valore della merce sostituita.

## SPESE

Per i pagamenti a mezzo tratte o ricevute bancarie verranno addebitati tutti gli oneri accessori alla riscossione.

## CONTROVERSIE

Per ogni controversia il Foro competente sarà esclusivamente quello di Macerata.

## EFFICACIA

Il Cliente, con il solo fatto di conferire l'ordinativo, si dichiara edotto ed accetta tutte le condizioni di vendita che precedono, salvo espresso patto contrario.

## MARCHIO

Il marchio  è un marchio commerciale registrato, la proprietà dei diritti di utilizzazione economica appartengono esclusivamente a l'AZIENDA o a terzi, pertanto è espressamente vietato l'utilizzo senza il preventivo consenso scritto del proprietario. L'utilizzo del marchio da parte dei clienti ai fini pubblicitari dovrà comunque essere preventivamente autorizzato dall'AZIENDA previa presa visione del materiale prima della pubblicazione. In ogni caso il logo non potrà subire alcuna modifica od alterazione nelle forme e nei colori ne potrà essere associato a prezzi o sconti promozionali.

# GENERAL SALES CONDITIONS

## VALIDITY

This price list replaces and annuls all previous versions.

It does not constitute an offer and may be subject to change following a written notification by COMPANY to the Customer, at any time and without prior notice.

Any modifications or updates shall apply to all orders received by or transmitted to COMPANY following the above-mentioned written notification.

## RETAIL PRICES AND PAYMENT TERMS

The retail prices quoted are exclusive of VAT and the WEEE fee and are ex works.

Upon expiry of the agreed payment term, COMPANY shall be authorised to issue bills of exchange for any outstanding amounts on every item, plus interest, expenses and any other additional liability, prior notification to the Customer. In the event of payment after the agreed term, accrued interest shall be charged in compliance with Italian Legislative Decree no. 231/2002, while any discounts expressly granted in relation to the payment terms shall be recovered.

If payment is not received within the agreed terms, COMPANY shall be entitled to suspend fulfilment of current orders, prior notification to the Customer.

## DELIVERY

The delivery term is calculated in working days and takes effect from the date on which the sales contract is stipulated. In any case, the contract is considered effective within 8 days from order transmission or, at all events, within 8 days from the most recent clarification (if requested) provided by the Customer. The delivery term shall be automatically extended should any events occur that are not imputable to COMPANY or that are due to force majeure. Partial deliveries can always be effected.

## THE PRODUCT

Any technical data relating to the products illustrated in this price list is purely indicative. The COMPANY reserves the right to effect any technical or structural modifications to improve the product, without prior notice. The goods may differ to some extent from the specifications given in the price list and the catalogue, or not be identical in all aspects to the samples viewed at the time of the order, since tolerances in relation to colours and tonalities are inevitable. Conformity with the samples is not obligatory. This right extends to household appliances or other kitchen furniture accessories; the appearance of the latter may differ slightly depending on the brand in question (which may differ from that shown in the catalogue), without prejudice to the basic conformity of features and functions. The Client may request specific components of a given brand from the range of products offered by the COMPANY, which is not liable in any way for the load bearing capacity of supports depending on the characteristics of the walls to which they are mounted; the Client alone is responsible for ensuring that the walls are able to support the load.

## CONSISTENCY OF THE FINISHES

The finishes may be subject to slight changes in colour over time as a result of exposure to light, heat, vapours and ageing. Therefore, in the event of completion orders, there may be shade differences that will tend to diminish over time. Regarding marble and granite worktops, we cannot guarantee uniformity of colour and vein pattern as the worktops are cut from NATURAL BLOCKS. These factors may not provide grounds for claims or return of products.

## TRANSPORT

The goods never travel on vehicles owned by COMPANY; therefore, from the moment the goods are handed over to the forwarder and regardless of who entrusted the latter with the transport or loaded the goods into the customer's vehicle, all risks are transferred to the customer. The Customer - also through persons delegated by the latter - is obliged to check the integrity of the goods upon their arrival, and to notify written claims to the Forwarder. The Customer should not accept any damaged goods that are unsuitable for their intended use, and should notify the relevant claim on the transport document; otherwise, by signing the transport document without adding any claims and/or observations, the Customer certifies the integrity and conformity of the goods.

## INSTALLATION AND USE

The COMPANY is not liable for incorrect or improper installation of the supplied product (units, tops, household appliances, electrical and plumbing systems, etc.), whether manufactured by the company or by third parties, unless the COMPANY itself does the installation. The purchaser may not claim for any damages caused during installation. Moreover, the COMPANY is not liable for the operation of household appliances and accessories manufactured by third parties, for which user and maintenance manuals are provided by the manufacturer in question; the manuals include information regarding the Claims Office or Technical Assistance Centres of the third party manufacturer. As regards improper and/or inadequate maintenance, or any improper and/or inadequate use of the products sold, the COMPANY transfers all liability and/or resulting costs to the Client or User.

## CLAIMS

Any faults or defects must be reported to COMPANY within the terms specified by the law. Payment may not be suspended, even in the event of notification of claims.

The goods shall remain the property of COMPANY unless fully paid by customer.

## WARRANTY

Warranty on sold products in favour of the purchaser shall apply for the minimum duration specified case-by-case by the laws in force in the Customer's country.

## RETURN OF GOODS

Return of sold goods is only accepted if expressly authorised by LUBE INDUSTRIES s.r.l.. Replacement or reimbursement of said goods shall be mutually defined only if the goods return is due to events imputable to LUBE INDUSTRIES s.r.l.. The returned goods must be delivered in perfect conditions and suitably packaged.

The goods to be replaced must be returned from the retailer to the producer without delay. In the case that the goods are returned until six months after replacing the producer will credit the retailer 100% of the replaced goods value; between six and nine months after replacing, the producer will credit the retailer 70% of the replaced goods value; if the return is between nine and twelve months after the replacement, will be credited to the retailer 50% of the replaced goods value; if the refund is not made within twelve months will not be credited any of the replaced goods value.

## EXPENSES

For payments effected through bill of exchange or cash order, all additional collection expenses shall be charged.

## DISPUTES

The Court of Macerata shall have sole jurisdiction for any disputes that may arise.

## EFFECTIVENESS

For the sole fact of conferring the order, the Customer declares to be informed and accepts all the aforementioned sale conditions, unless otherwise expressly agreed on.

## BRAND

The trademark  is registered; the right of the commercial exploitation belongs only to the COMPANY or a third party, and the trademark may not be used without the owner's written consent. The client may only use the trademark for reasons of publicity if authorised in advance by COMPANY, following review of the material before publication.

In any case, the logo may not be modified or altered in form or colour, nor may it be associated with promotional prices or discounts.

## INFORMAZIONI TECNICHE

### TECHNICAL INFORMATION

Le misure indicate nel presente listino sono espresse in cm.

Le profondità delle basi si intendono comprensive di top.

Le profondità dei pensili e delle colonne si intendono comprensive di ante.

Le altezze delle basi e delle colonne si intendono comprensive di zoccolo

Il verso degli elementi è individuato dalla posizione delle cerniere. Fanno eccezione solo l'angolo base e la colonna ad angolo dove il verso viene individuato dalla posizione dell'anta rispetto al mobile.

Per gli elementi con il verso, è stato inserito il codice con entrambi i versi (ad esempio una base da cm 45 cod. E4010451/2).

Sarà quindi necessario specificare se l'ultima cifra dovrà essere "1" per il verso destro cioè E4010451 oppure "2" per il verso sinistro cioè E4010452.

Per i lavelli il verso dx o sx è individuato dalla posizione delle vasche.

I prezzi indicati sono espressi all'unità di euro e sono IVA e contributo RAEE esclusi

I prezzi delle basi e delle colonne sono comprensivi dello zoccolo standard.

Per tutti i mobili fuori misura ha valore il listino riportato nella pagina maggiorazioni fuori misura.

Nel caso vengano richieste maniglie con passo diverso da quello previsto dal modello, le ante verranno fornite senza fori maniglia.

**I colori delle immagini riportate nel presente listino sono solamente indicativi e non possono essere utilizzati come riferimento.**

The measurements appearing in this price list are expressed in cm.

The depths of base units are inclusive of the worktop.

The depths of the wall units and columns are inclusive of the doors.

The heights of the base units and columns are inclusive of the plinth.

The direction of the elements is determined by the position of the hinges. The only exceptions are the corner base unit and corner column, where the direction is determined by the position of the door in relation to the cabinet.

For elements that come with a direction, the code includes both directions (e.g. 45 cm base unit - code E4010451/2).

It is therefore necessary to specify the last figure - "1" for the RH direction, i.e. E4010451, or "2" for the LH direction, i.e. E4010452.

The RH or LH direction of the sinks is determined by the position of the bowls.

The prices indicated are expressed in units of Euro and exclude VAT and the WEEE fee.

Prices of the base units and columns are inclusive of the standard plinth.

The prices that apply to all custom-sized cabinets are indicated on the page "Surcharges for custom-sized elements".

In the event of handles requested with a different centre-to-centre distance compared to the standard for the model, the doors will be supplied without pre-drilled holes for the handles.

**The colours in the pictures appearing in this price list are purely indicative and should not be used as reference.**

## COMPOSIZIONI SENZA ELETTRODOMESTICI E SENZA TOP

### COMPOSITIONS WITHOUT HOUSEHOLD APPLIANCES AND WORKTOP

**Tutte le composizioni richieste prive di elettrodomestici (frigo, forno, piano cottura, lavastoviglie o lavatrice), saranno aumentate di un importo netto pari a € 150 iva esclusa. Tale direttiva non si applica se la cucina contiene almeno due di questi elettrodomestici.**

**Tutte le composizioni richieste prive di top, saranno aumentate di un importo netto pari a € 100 iva esclusa.**

All compositions requested without household appliances (fridge, oven, cooker hob, dishwasher or washing machine) shall be subject to a price increase of € 150 VAT excluded.

This measure does not apply if the kitchen contains at least two of the above-mentioned appliances.

All compositions requested without worktop shall be subject to a price increase of € 100 VAT excluded.

# MAGGIORAZIONI PER ELEMENTI FUORI MISURA

## SURCHARGES FOR CUSTOM-SIZED ELEMENTS

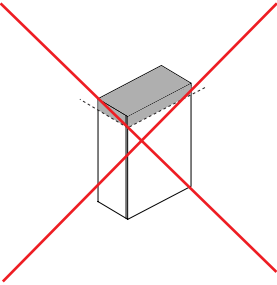
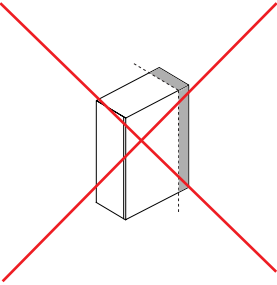
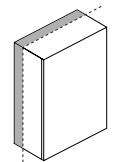
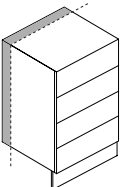
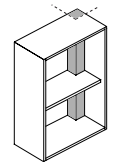
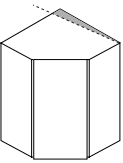
	DESCRIZIONE DESCRIPTION	MAGGIORAZIONE SURCHARGE		DESCRIZIONE DESCRIPTION	MAGGIORAZIONE SURCHARGE
	<p>Riduzioni in altezza non realizzabili</p> <p>The height cannot be reduced</p>			<p>Basi angolo fuori squadra</p> <p>Out-of-plumb corner base units</p>	
		<p><b>Basi</b> Base units NO</p> <p><b>Pensili</b> Wall units NO</p> <p><b>Colonne</b> Columns NO</p>			+ 28 %
	<p>Riduzioni in larghezza non realizzabili</p> <p>The Width cannot be reduced</p>			<p>Basi e sottolavelli con portabombola</p> <p>Base and sink base units with cylinder holder</p>	
		<p><b>Basi</b> Base units NO</p> <p><b>Pensili</b> Wall units NO</p> <p><b>Colonne</b> Columns NO</p>			+ 20 €
	<p>Riduzioni in profondità</p> <p>Depth reduction</p>			<p>Maggiorazioni per fianco scavato per inserimento piano cottura tra due basi (PPC opz. 011/012)</p> <p>Surcharge for digged side to insert cooking hob between two bases (PPC opt. 011/012)</p>	
		<p><b>Basi</b> Base units + 18 %</p> <p><b>Pensili</b> Wall units + 18 %</p> <p><b>Colonne</b> Columns + 18 %</p>			
					<b>Cadauno</b> each + 23 €
	<p>Riduzioni per cassetiera</p> <p><b>N.B.: modificabili solo in profondità fino a 31 cm al fianco</b></p> <p>Reductions for drawer unit</p> <p><b>Note: can only be modified depth-wise up to 31 cm on the side</b></p>			<p>Maggiorazioni per raggiatura top e mensola in laminato</p> <p>Surcharges for rounded edge on laminate worktop and shelf</p>	
					<b>Codice</b> code T9STP + 35 €
	<p>Taglio per pilastro</p> <p><b>N.B.: non realizzabile nei pensili con meccanismi</b></p> <p>Indent for pilaster</p> <p><b>Note: not feasible on wall units with mechanisms</b></p>			<p>Maggiorazione per inserimento tubo cappa (da sommare al prezzo del pensile)</p> <p>Surcharge for insertion of the hood pipe (to be added to the price of the wall unit)</p>	
		<p><b>Basi</b> Base units + 90 €</p> <p><b>Pensili</b> Wall units + 90 €</p> <p><b>Colonne</b> Columns + 130 €</p>			+ 90 €
	<p>Pensili angolo fuori squadra</p> <p>Out-of-plumb corner wall units</p>			<p>Maggiorazione per inserimento cappa non standard</p> <p><b>N.B.: verificare sempre la fattibilità dell'incasso con il nostro ufficio tecnico</b></p> <p>Surcharge for the insertion of a non-standard hood</p> <p><b>Note: always verify the feasibility of the installation</b></p>	
					+ 90 €
					+ 28 %

La maggiorazione è da applicare al prezzo dell'elemento di serie più grande rispetto a quello delle dimensioni richieste.

Negli elementi fuori misura per motivi di lavorazione, l'estetica può risultare inferiore agli elementi di serie.

The surcharge applies to the price of the standard element that is next largest to that of the requested size.

Due to the processing involved, the aesthetic level of custom-sized elements may be slightly inferior to that of standard elements.

# aurea

Aurea nasce dalla brillante intuizione di utilizzare la Sezione Aurea per la definizione delle proporzioni del disegno dell'anta, per realizzare un prodotto esclusivo, dall'armoniosa classicità. Il modello Aurea viene declinato in tre tipologie di Stili diversi: lo stile NEW FOLK, il CONTEMPORANEO e il CLASSICO, tutti caratterizzati da elementi e accessori appositamente studiati da Creo Kitchens. Con il programma Aurea, si possono realizzare composizioni per ambienti di ogni dimensione e tipologia, personalizzandoli e rendendoli emozionalmente unici.



Aurea arises from the brilliant intuition to use the Aurea Section to define proportions of the door design, to create an exclusive product, with a harmonious classicism. Aurea model is available in three different styles: the NEW FOLK, the CONTEMPORARY and the CLASSIC one, all characterized by items and accessories specifically designed by Creo Kitchens. The Aurea program allows to create compositions for all kinds of environments, customizing and making them emotionally unique.



## CREO ECOLOGIC

IL GRUPPO LUBE HA SCELTO DI UTILIZZARE PER I COMPONENTI COSTITUENTI LE STRUTTURE DELLE CUCINE SOLO MATERIALE A BASSISSIMA EMISSIONE DI FORMALDEIDE: CONFORMI ALLO STANDARD F4STELLE SECONDO LA NORMA JIS, CERTIFICATO DAL MINISTERO GIAPPONESE, IL PIÙ SEVERO IN MERITO ALLE NORMATIVE DI SALVAGUARDIA AMBIENTALE.

LUBE GROUP HAS CHOSEN TO EXCLUSIVELY USE MATERIALS WITH VERY LOW FORMALDEHYDE EMISSIONS FOR THE COMPONENTS MAKING UP THE KITCHEN CARCASSES: THESE ELEMENTS COMPLY WITH THE F4 STAR STANDARD ACCORDING TO JIS, CERTIFIED BY THE JAPANESE GOVERNMENT - THE MOST STRINGENT WHEN IT COMES TO ENVIRONMENTAL PROTECTION.

N.B.: i prezzi sono espressi all'unità di euro (iva esclusa)

## CARATTERISTICHE TECNICHE

ANTE	intelaiata sp.22 mm in massello di frassino con bugna impiallacciato frassino nei colori: laccato bianco a poro aperto (opz.2451), tinto corda decapè (opz.2452), laccato grigio reale a poro aperto (opz.2454), laccato bianco artico a poro aperto (opz.2491)
ANTE CON BUGNA MAGNETICA EFFETTO LAVAGNA	disponibili nelle misure 71,7x44,7 - 71,7x59,7 - 35,7x44,7 - 35,7x59,7 - 35,7x89,7 - 47,7x59,7 - 47,7x89,7 - 131,7x44,7 - 131,7x59,7 nei colori: laccato bianco a poro aperto (opz.2451L), laccato bianco artico a poro aperto (opz.2491L)
ANTE CON INTARSIO	disponibili nelle misure 71,7x44,7 - 71,7x59,7 - 35,7x44,7 - 35,7x59,7 - 35,7x89,7 nei colori: laccato bianco a poro aperto (opz.2451D), tinto corda decapè (opz.2452D)
ANTE CON DECORO METALLICO	disponibili nelle misure 71,7x44,7 - 71,7x59,7 - 35,7x44,7 - 35,7x59,7 - 35,7x89,7 - 95,7x44,7 - 95,7x59,7 - 131,7x59,7 nei colori: laccato bianco a poro aperto (opz.2451M), tinto corda decapè (opz.2452M), con placchetta in metallo finitura canna di fucile spazzolato
FRONTALI CASSETTI	in massello di frassino nei colori: laccato bianco a poro aperto (opz.2451), tinto corda decapè (opz.2452), tinto noce spazzolato (opz.2453), laccato grigio reale a poro aperto (opz.2454), laccato bianco artico a poro aperto (opz.2491)
ANTE VETRO di serie	VETRO SATINATO BIANCO SP.4 MM FILO GREZZO, TEMPERATO, DUE LATI VERTICALI SERIGRAFATI BIS.23, INCISO LUCIDO LATO SATINATO telaio sp.22 mm in massello di frassino nelle finiture: laccato bianco a poro aperto (opz.2451S), corda decapè (opz.2452S), laccato grigio reale a poro aperto (opz.2454S), laccato bianco artico a poro aperto (opz.2491S)
a richiesta	VETRO TRASPARENTE SP.4 MM FILO GREZZO, TEMPERATO, SERIGRAFATO EFFETTO TESSUTO IN VERNICE COLORE BIANCO, TELAIO INGLESINA telaio sp.22 mm in massello di frassino con bugna impiallacciato frassino nei colori: laccato bianco a poro aperto (opz.2451I), corda decapè (opz.2452I), laccato grigio reale a poro aperto (opz.2454I), laccato bianco artico a poro aperto (opz.2491I)
MANIGLIE	<b>di serie:</b> 200 finitura argento antico passo mm 128 per anta L 15 pomo 200P finitura argento antico  <b>a richiesta:</b> 240 finitura canna di fucile spazzolato passo mm 160 per anta L 15 pomo 240P finitura canna di fucile spazzolato 255R finitura rame antico passo mm 160 per anta L 15 pomo finitura rame antico 255RP 185 finitura ottone vecchio chiaro passo mm 96 per anta L 15 pomo finitura ottone vecchio 228P  236 finitura cromo passo mm 128 per anta L 15 pomo 244P pomo finitura cromo 172 finitura argento vecchio brillante passo mm 96 241 finitura cromo satinato passo mm 64/160 in funzione dell'anta
STRUTTURE	<b>ANTA: laccato bianco a poro aperto</b> nobilitato bianco camelia (opz.606), schiena e ripiano bianco (opz.001)  <b>ANTA: tinto corda decapè</b> nobilitato juta effetto tela (opz.9490) schiena e ripiano visone (opz.948M)  <b>ANTA: laccato bianco artico</b> nobilitato bianco (opz.001) schiena e ripiano bianco (opz.001)  <b>ANTA: laccato grigio reale</b> nobilitato grigio effetto tela (opz.9695) schiena e ripiano argilla (opz.9690)
MENSOLE	<b>di serie:</b> altezza 3,8 cm in laminato, bianco camelia (opz.606), bianco (opz.001), visone (opz.948M), argilla (opz.9690) <b>a richiesta:</b> altezza 3,8 cm impiallacciate finiture come ante
ZOCCOLI	<b>di serie:</b> altezza 15 cm in pvc ricoperti in melamina nei colori: laccato bianco (opz.569), corda decapè (opz.566), bianco artico (opz.590), grigio reale (opz.595) <b>a richiesta:</b> altezza 15 cm in alluminio liscio finitura brill (opz.412), vedi maggiorazione pag.15



**SP. 22 MM**

Note: the prices are expressed in units of euro (vat excluded)

**TECHNICAL FEATURES**

<b>DOORS</b>	22-mm thick frame in solid ash with ash veneered raised panel in the following colours: white lacquered open pore (opt.2451), stained pickled jute (opt.2452), royal grey lacquered open pore (opt.2454), arctic white lacquered open pore (opt.2491)
<b>DOOR WITH RAISED PANEL MAGNETIC EFFECT BLACKBOARD</b>	available in the following sizes 71.7x44.7 - 71.7x59.7 - 35.7x44.7 - 35.7x59.7 - 35.7x89.7 - 47.7x59.7 - 47.7x89.7 - 131.7x44.7 - 131.7x59.7 and in the following colours: white lacquered open pore (opt.2451L), arctic white lacquered open pore (opt.2491L)
<b>DOOR WITH INLAYD</b>	available in the following sizes 71.7x44.7 - 71.7x59.7 - 35.7x44.7 - 35.7x59.7 - 35.7x89.7 and in the following colours: white lacquered open pore (opt.2451D), stained pickled jute (opt.2452D)
<b>DOOR WITH METALLIC DECOR</b>	available in the following sizes 71.7x44.7 - 71.7x59.7 - 35.7x44.7 - 35.7x59.7 - 35.7x89.7 - 95.7x44.7 - 95.7x59.7 - 131.7x59.7 and in the following colours: white lacquered open pore (opt.2451M), stained pickled jute (opt.2452M), with metal plate brushed gunmetal finish
<b>DRAWER FRONT PANELS</b>	in solid ash in the following colours: white lacquered open pore (opt.2451), stained pickled jute (opt.2452), walnut stained brushed (opt.2453) royal grey lacquered open pore (opt.2454), arctic white lacquered open pore (opt.2491)
<b>GLASS DOORS standard</b>	WHITE FROSTED-FINISH GLASS 4-MM THICK NATURAL BEVEL, TOUGHENED, TWO SCREEN-PRINTED VERTICAL SIDES BIS.23, HIGH-SHEEN ETCHING FROSTED-FINISH SIDE 22-mm thick solid ash frame in the following finishes: white lacquered open pore (opt.2451S), pickled jute (opt.2452S), royal grey lacquered open pore (opt.2454S), arctic white lacquered open pore (opt.2491S)
<b>on request</b>	4-MM THICK CLEAR GLASS, NATURAL BEVEL, TOUGHENED, HIGH-GLOSS FABRIC-EFFECT SILK-SCREENPRINT WHITE, FRAME WITH MULLION ACCENTS 22-mm thick frame in solid ash with raised panel in veneered ash in the following colours: white lacquered open pore (opt.2451I), pickled jute (opt.2452I), royal grey lacquered open pore (opt.2454I), arctic white lacquered open pore (opt.2491I)
<b>HANDLES</b>	<b>standard:</b> 200 antique silver finish, 128 mm centre-to-centre distance for door W 15 antique silver finish knob hole 200P  <b>on request:</b> 240 brushed gunmetal finish, 160 mm centre-to-centre distance for door W 15 brushed gunmetal finish knob hole 240P  255R antique copper finish, centre-to-centre distance 160 mm for door W 15 antique copper finish knob 255RP  185 with light old brass finish, 96 mm centre-to-centre distance for door W 15 with light old brass finish knob hole 228P  236 chrome finish, 128 mm centre-to-centre distance for door W 15 chrome-finish knob hole 244P  172 in polished old silver finish, 96 mm centre-to-centre distance  241 satin chrome finish, 64/160 mm centre-to-centre distance depending on the door
<b>STRUCTURES</b>	<b>DOOR: white lacquered open pore</b> melamine-coated camellia white (opt.606), white back panel and shelf (opt.001)  <b>DOOR: stained pickled jute</b> jute melamine-coated canvas effect (opt.9490) mink back panel and shelf (opt.948M)  <b>DOOR: arctic white lacquered</b> melamine-coated white (opt.001), white back panel and shelf (opt.001)  <b>DOOR: royal grey lacquered</b> grey melamine-coated canvas effect (opt.9695) clay back panel and shelf (opt.9690)
<b>SHELVES</b>	<b>standard:</b> height 3.8 cm in laminate, camellia white (opt.606), white (opt.001), mink (opt.948M), clay (opt.9690)  <b>on request:</b> height 3.8 cm, veneered with same finishes as doors
<b>PLINTHS</b>	<b>standard:</b> height 15 cm in PVC coated with melamine in the following colours: lacquered white (opt.569), pickled jute (opt.566), arctic white (opt.590), royal grey (opt.595)  <b>on request:</b> height 15 cm, smooth aluminium with brill finish (opt.412), see surcharges on page 15



cod. **K70** SP. 22 MM

*aurea*

ante in frassino laccate bianche a poro aperto  
white lacquered ash doors open pore



anta (opz.2451)  
door (opt.2451)



anta con intarsio  
(opz.2451D)  
door with inlayd  
(opt.2451D)



anta con decoro metallico  
(opz.2451M)  
door with metallic decor  
(opt.2451M)



anta con lavagna magnetica  
(opz.2451L)  
door with magnetic blackboard  
(opt.2451L)

 *colori in pronta consegna  
available colours*

**PREZZI FASCIA "A"  
PRICES BAND "A"**

cassetto e cestoni in frassino laccato bianco a poro aperto  
white lacquered ash drawer and deep drawers open pore



cassetto (opz.2451)  
drawer (opt.2451)



cestone (opz.2451)  
deep drawer (opt.2451)



cestone con intarsio  
(opz.2451D)  
deep drawer with inlayd  
(opt.2451D)



cestone con decoro  
metallico (opz.2451M)  
deep drawer with metallic  
decor (opt.2451M)

ante in frassino laccate bianco artico a poro aperto  
arctic white lacquered ash doors open pore



anta (opz.2491)  
door (opt.2491)



anta con lavagna magnetica  
(opz.2491L)  
door with magnetic blackboard  
(opt.2491L)

 *colori in pronta consegna  
available colours*

**PREZZI FASCIA "A"  
PRICES BAND "A"**

cassetto e cestoni in frassino laccate bianco artico a poro aperto  
arctic white lacquered ash drawer and deep drawers open pore



cassetto (opz.2491)  
drawer (opt.2491)



cestone (opz.2491)  
deep drawer (opt.2491)

cod. **K70** SP. 22 MM

*aurea*

ante in frassino tinto corda decapè  
pickled jute ash doors



anta (opz.2452)  
door (opt.2452)



anta con intarsio  
(opz.2452D)  
door with inlayd  
(opt.2452D)



anta con decoro metallico  
(opz.2452M)  
door with metallic decor  
(opt.2452M)

PREZZI FASCIA "B"  
PRICES BAND "B"

cassetto e cestoni in frassino tinto corda decapè  
pickled jute ash drawer and deep drawers



cassetto (opz.2452)  
drawer (opt.2452)



cestone (opz.2452)  
deep drawer (opt.2452)



cestone con intarsio  
(opz.2452D)  
deep drawer with inlayd  
(opt.2452D)



cestone con decoro  
metallico (opz.2452M)  
deep drawer with metallic  
decor (opt.2452M)

ante in frassino laccate grigio reale a poro aperto  
royal grey lacquered ash doors open pore



anta (opz.2454)  
door (opt.2454)

PREZZI FASCIA "B"  
PRICES BAND "B"

cassetto e cestoni in frassino laccate grigio reale a poro aperto  
royal grey lacquered ash drawer and deep drawers open pore



cassetto (opz.2454)  
drawer (opt.2454)



cestone (opz.2454)  
deep drawer (opt.2454)

SP. 22 MM

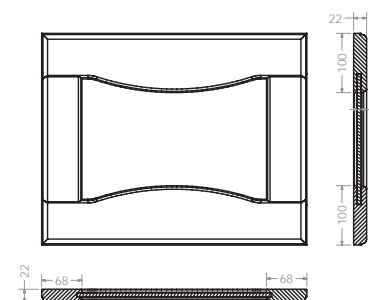

ante vetro in frassino laccate bianche a poro aperto  
white lacquered ash glass doors open pore

 *colori in pronta consegna  
available colours*

PREZZI FASCIA "A"  
PRICES BAND "A"



anta vetro satinato bianco  
inciso lucido con due  
lati verticali serigrafati  
(opz.2451S)  
white frosted glass door  
high-shine etching on two  
vertical screenprinted sides  
(opt.2451S)



anta vetro trasparente  
serigrafato effetto tessuto  
con inglesina (opz.2451I)  
fabric-effect screenprinted  
clear glass door with mullion  
accents (opt.2451I)



cestone vetro satinato  
bianco inciso lucido con  
due lati verticali serigrafati  
(opz.2451S)  
deep drawers in white frosted  
glass with high-shine etching  
on two vertical screenprinted  
sides (opt.2451S)



cestone vetro trasparente  
serigrafato effetto tessuto  
con inglesina (opz.2451I)  
fabric-effect screenprinted  
clear glass deep drawer  
with mullion accents  
(opt.2451I)

ante vetro in frassino laccate bianco artico a poro aperto  
arctic white lacquered ash glass doors open pore

 *colori in pronta consegna  
available colours*

PREZZI FASCIA "A"  
PRICES BAND "A"



anta vetro satinato bianco  
inciso lucido con due  
lati verticali serigrafati  
(opz.2491S)  
white frosted glass door  
high-shine etching on two  
vertical screenprinted sides  
(opt.2491S)



anta vetro trasparente  
serigrafato effetto tessuto  
con inglesina (opz.2491I)  
fabric-effect screenprinted  
clear glass door with mullion  
accents (opt.2491I)



cestone vetro satinato  
bianco inciso lucido con  
due lati verticali serigrafati  
(opz.2491S)  
deep drawers in white frosted  
glass with high-shine etching  
on two vertical screenprinted  
sides (opt.2491S)



cestone vetro trasparente  
serigrafato effetto tessuto  
con inglesina (opz.2491I)  
fabric-effect screenprinted  
clear glass deep drawer  
with mullion accents  
(opt.2491I)

ante vetro in frassino tinto corda decapè  
pickled jute ash glass doors

PREZZI FASCIA "B"  
PRICES BAND "B"



anta vetro satinato bianco  
inciso lucido con due  
lati verticali serigrafati  
(opz.2452S)  
white frosted glass door  
high-sheen etching on two  
vertical screenprinted sides  
(opt.2452S)



anta vetro trasparente  
serigrafato effetto tessuto  
con inglesina (opz.2452I)  
fabric-effect screenprinted  
clear glass door with mullion  
accents (code 2452I)



cestone vetro satinato  
bianco inciso lucido con  
due lati verticali serigrafati  
(opz.2452S)  
deep drawers in white frosted  
glass with high-sheen etching  
on two vertical screenprinted  
sides (opt.2452S)



cestone vetro trasparente  
serigrafato effetto tessuto  
con inglesina (opz.2452I)  
fabric-effect screenprinted  
clear glass deep drawer  
with mullion accents  
(opt.2452I)

ante vetro in frassino laccate grigio reale a poro aperto  
royal grey lacquered ash glass doors open pore

PREZZI FASCIA "B"  
PRICES BAND "B"



anta vetro satinato bianco  
inciso lucido con due  
lati verticali serigrafati  
(opz.2454S)  
white frosted glass door  
high-sheen etching on two  
vertical screenprinted sides  
(opt.2454S)



anta vetro trasparente  
serigrafato effetto tessuto  
con inglesina (opz.2454I)  
fabric-effect screenprinted  
clear glass door with mullion  
accents (code 2454I)



cestone vetro satinato  
bianco inciso lucido con  
due lati verticali serigrafati  
(opz.2454S)  
deep drawers in white frosted  
glass with high-sheen etching  
on two vertical screenprinted  
sides (opt.2454S)



cestone vetro trasparente  
serigrafato effetto tessuto  
con inglesina (opz.2454I)  
fabric-effect screenprinted  
clear glass deep drawer  
with mullion accents  
(opt.2454I)

SP. 22 MM

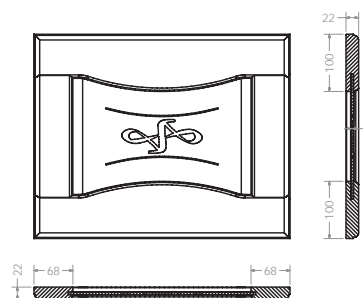

anta vetro satinato bianco  
white frosted glass door

SP. 22 MM

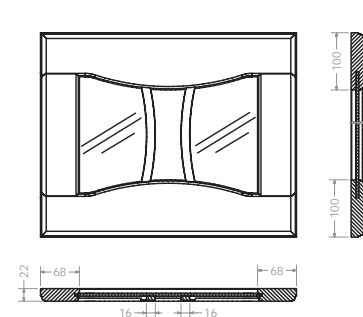

anta vetro con inglesina  
glass door with mullion accents

cod. **K70**

*aurea*

**elementi da 15 con fresata** n.b.: per prezzi vedi pagg.102-103  
15 cm elements with groove - Note: for prices see pages 102-103

---

PREZZI FASCIA "A"  
PRICES BAND "A"



laccata bianca a poro aperto (opz.2451)  
white lacquered open pore (opt.2451)

PREZZI FASCIA "A"  
PRICES BAND "A"



laccata bianco artico a poro aperto (opz.2491)  
arctic white lacquered open pore (opt.2491)

PREZZI FASCIA "B"  
PRICES BAND "B"



tinto corda decapè (opz.2452)  
pickled jute (opt.2452)

PREZZI FASCIA "B"  
PRICES BAND "B"



laccata grigio reale a poro aperto (opz.2454)  
royal grey lacquered open pore (opt.2454)

**MANIGLIE HANDLES**

---

**DI SERIE STANDARD**



Maniglia 200 finitura argento antico  
passo 128 mm

Handle 200 antique silver finish  
centre-to-centre distance 128 mm



Pomo 200P finitura argento antico  
passo 16 mm

Knob hole 200P antique silver finish  
centre-to-centre distance 16 mm

**A RICHIESTA ON REQUEST**



Maniglia 240 finitura canna di fucile spazzolato  
passo 160 mm

Handle 240 brushed gunmetal finish  
centre-to-centre distance 160 mm



Pomo 240P finitura canna di fucile spazzolato  
utilizzato per elementi da 15 con maniglia 240

Knob hole 240P brushed gunmetal finish  
used for 15 cm elements with handle 240

**A RICHIESTA ON REQUEST**



Maniglia 241 finitura cromo satinato  
passo 64 mm

Handle 241 satin chrome finish  
centre-to-centre distance 64 mm  
centre-to-centre distance 160 mm

**A RICHIESTA ON REQUEST**



Maniglia 236 finitura cromo  
passo 128 mm

Handle 236 chrome finish  
centre-to-centre distance 128 mm



Pomo 244P finitura cromo  
utilizzato per elementi da 15 con maniglia 236

Knob hole 244P chrome finish  
used for 15 cm elements with handle 236

**A RICHIESTA ON REQUEST**



Maniglia 172 finitura argento vecchio brillante  
passo 96 mm

Handle 172 polished old silver finish  
centre-to-centre distance 96 mm

**A RICHIESTA ON REQUEST**



Maniglia 185 finitura ottone  
vecchio chiaro  
passo 96 mm

Handle 185 light old brass finish  
centre-to-centre distance 96 mm



Pomo 228P finitura ottone vecchio  
utilizzato per elementi da 15 con maniglia 185

Knob hole 228P with old brass finish  
used for 15 cm elements with handle 185



Maniglia 255R finitura rame antico  
passo 160 mm

Handle 255R antique copper finish  
160 mm centre-to-centre distance



Pomo 255RP finitura rame antico  
utilizzato per elementi da 15  
con maniglia 255R

Knob hole 255RP antique copper finish  
used for 15 cm elements with handle 255R

## strutture carcasses



bianco camelia (opz.606)  
schiena e ripiano bianco (opz.001)  
camellia white (opt.606)  
white back panel and shelf (opt.001)



bianco (opz.001)  
schiena e ripiano bianco (opz.001)  
white (opt.001)  
white back panel and shelf (opt.001)



juta effetto tela (opz.9490)  
schiena e ripiano visone (opz.948M)  
jute melamine-coated canvas  
effect (opt.9490)  
mink back panel and shelf (opt.948M)



grigio effetto tela (opz.9695)  
schiena e ripiano argilla (opz.9690)  
grey melamine-coated canvas  
effect (opt.9695)  
clay back panel and shelf (opt.9690)



### CREO ECOLOGIC

IL GRUPPO LUBE HA SCELTO DI UTILIZZARE PER I COMPONENTI COSTITUENTI LE STRUTTURE DELLE CUCINE SOLO MATERIALE A BASSISSIMA EMISSIONE DI FORMALDEIDE: CONFORMI ALLO STANDARD F\*\*\*\* SECONDO LA NORMA JIS, CERTIFICATO DAL MINISTERO GIAPPONESE, IL PIU' SEVERO IN MERITO ALLE NORMATIVE DI SALVAGUARDIA AMBIENTALE.

LUBE GROUP HAS CHOSEN TO EXCLUSIVELY USE MATERIALS WITH VERY LOW FORMALDEHYDE EMISSIONS FOR THE COMPONENTS MAKING UP THE KITCHEN CARCASSES: THESE ELEMENTS COMPLY WITH THE F4 STAR STANDARD ACCORDING TO JIS, CERTIFIED BY THE JAPANESE GOVERNMENT - THE MOST STRINGENT WHEN IT COMES TO ENVIRONMENTAL PROTECTION.

## mensole in laminato laminate shelves



bianco camelia (opz.606)  
camellia white (opt.606)



bianco (opz.001)  
white (opt.001)

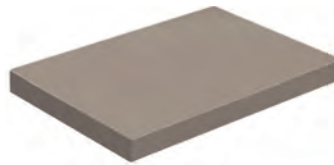

visone (opz.948M)  
mink (opt.948M)

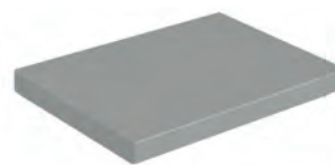

argilla (opz.9690)  
clay (opt.9690)

## mensole impiallacciate veneered shelves

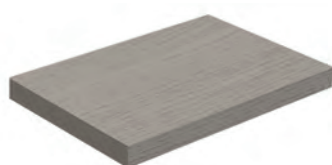

impiallacciata come anta  
N.B.: per le finiture vedi colore ante  
veneered same finish as door  
Note: for the finishes see door colours

## zoccoli in pvc H 15 pvc plinths H 15



laccato bianco (opz.569)  
white lacquer (opt.569)



bianco artico (opz.590)  
arctic white (opt.590)



corda decapè (opz.566)  
pickled jute (opt.566)



grigio reale (opz.595)  
royal grey (opt.595)

## zoccolo in alluminio H 15 aluminium plinth H 15

magg. rispetto allo zoccolo standard  
surcharges compared to standard plinth



alluminio liscio finitura brill (opz.412)  
smooth aluminium with brill finish (opt.412)

al ml  
per lm

cod.092155  
code

+20€

## cornici cappello top cornices



laccato bianco a poro aperto  
(opz.2451)  
white lacquered open pore  
(opt.2451)



laccato bianco artico a poro  
aperto (opz.2491)  
arctic white lacquered open pore  
(opt.2491)



tinto corda decapè (opz.2452)  
stained pickled jute (opt.2452)



laccato grigio reale a poro aperto  
(opz.2454)  
royal grey lacquered open pore  
(opt.2454)

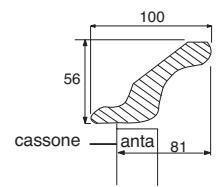

disegno cornice  
design cornice









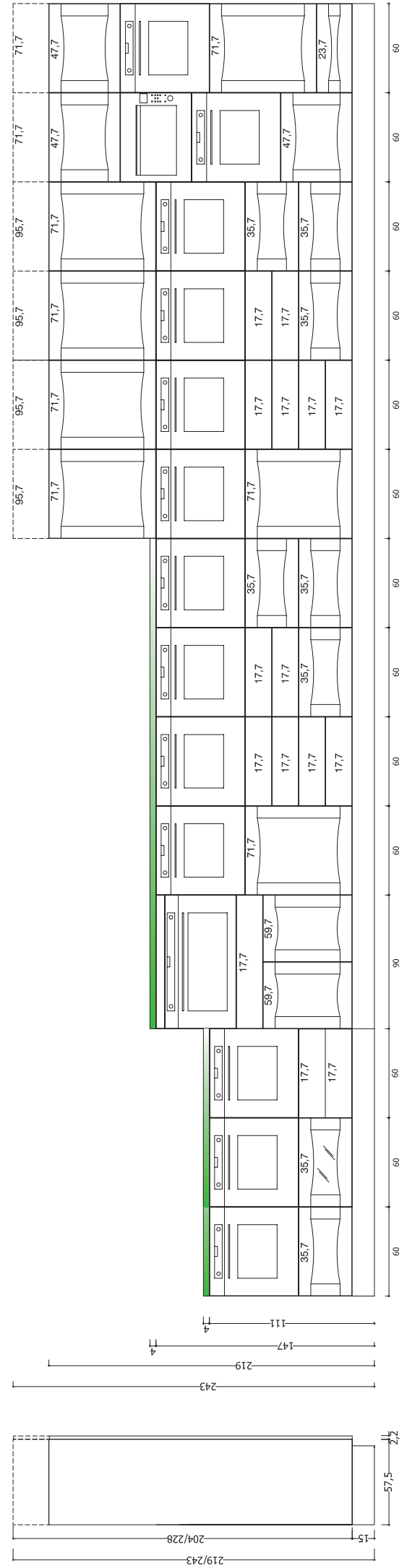
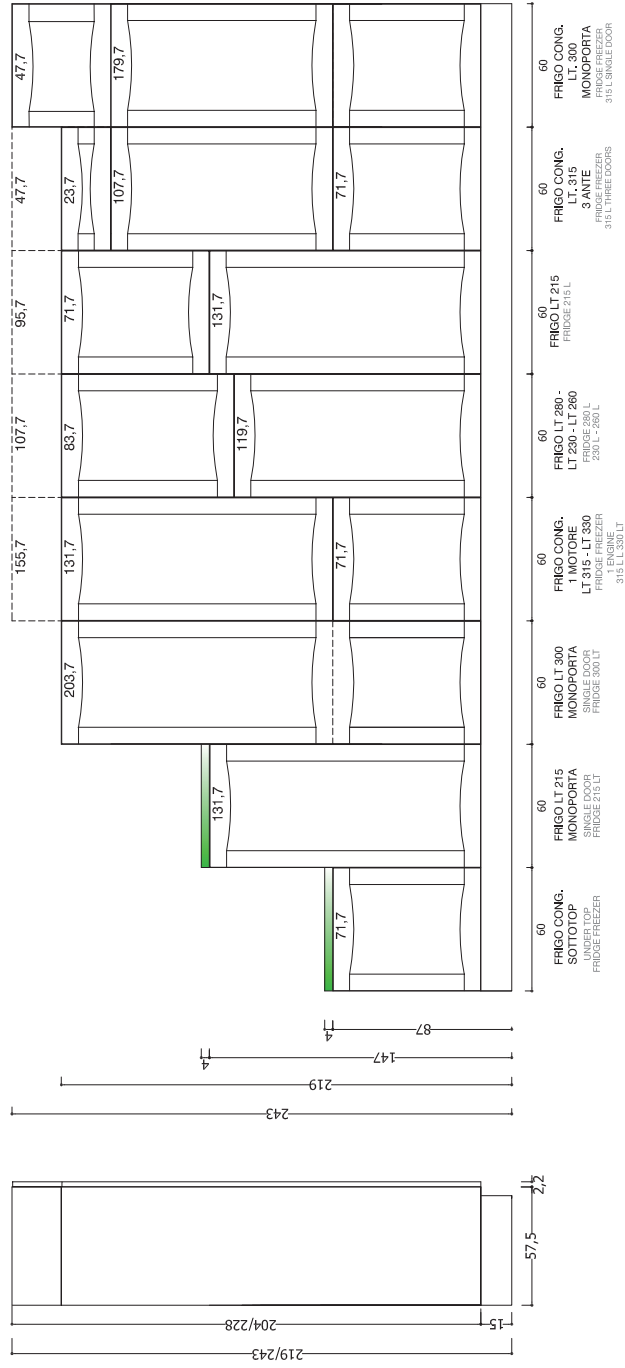













# MODULARITÀ E COMPONENTI MODULARITÀ E FITTING SOLUTIONS











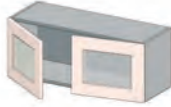

		COD.	FASCIA A K70	FASCIA B K70	MAGG. LAVAGNA			
 <p><b>1 anta H 36</b> 1 door H 36</p>	L 45	E2030451/2	116	133	+80			
	L 60	E2030601/2	123	142	+106			
			+15	+20				
			+50	+65				
		<p><b>mag.anta con intarsio</b> surcharge for door with inlaid</p> <p><b>mag.anta con decoro metallico</b> surcharge for door with metallic decor</p>						
 <p><b>1 anta H 48</b> 1 door H 48</p>	L 45	E2040451/2	133	153	—			
	L 60	E2040601/2	144	166	+157			
 <p><b>1 anta H 60</b> 1 door H 60</p>	L 45	E2060451/2	137	158	—			
	L 60	E2060601/2	158	184	—			
 <p><b>1 anta H 72</b> 1 door H 72</p>	L 15	E2010151/2	100	114	—			
	L 30	E2010301/2	129	148	—			
	L 40	E2010401/2	140	161	—			
	*L 45	E2010451/2	144	166	+173			
	*L 60	E2010601/2	168	197	+262			
	L 65	E2010651/2	181	214	—			
		<p><b>*mag.anta con intarsio</b> surcharge for door with inlaid</p> <p><b>*mag.anta con decoro metallico</b> surcharge for door with metallic decor</p>						
 <p><b>1 anta H 96</b> 1 door H 96</p>	L 15	E2020151/2	120	135	—			
	L 30	E2020301/2	154	177	—			
	L 40	E2020401/2	173	201	—			
	*L 45	E2020451/2	180	210	—			
	*L 60	E2020601/2	210	246	—			
	L 65	E2020651/2	226	268	—			
		<p><b>*mag.anta con decoro metallico</b> surcharge for door with metallic decor</p>						
 <p><b>cestello estraibile</b> <b>chiusura soft</b> pull-out basket unit soft-closing system</p>	H 72 L 15	E2010150	146	160	—			
	H 96 L 15	E2020150	181	196	—			







		COD.	FASCIA A K70	FASCIA B K70	MAGG. LAVAGNA		
 <p><b>2 ante H 36</b> 2 doors H 36</p>	L 90	E2030900	203	237	+160		
			+30	+40			
			+100	+130			
	<p><b>mag. ante con intarsio</b> surcharge for doors with inlaid <b>mag. ante con decoro metallico</b> surcharge for doors with metallic decor</p>						
 <p><b>2 ante H 48</b> 2 doors H 48</p>	L 90	E2040900	233	272	—		
 <p><b>2 ante H 60</b> 2 doors H 60</p>	L 90	E2060900	240	281	—		
 <p><b>2 ante H 72</b> 2 doors H 72</p>	L 60	E2010600	221	258	—		
	L 80	E2010800	242	285	—		
	*L 90	E2010900	251	295	+346		
			+30	+40			
			+100	+130			
<p><b>*mag. ante con intarsio</b> surcharge for doors with inlaid <b>*mag. ante con decoro metallico</b> surcharge for doors with metallic decor</p>							
 <p><b>2 ante H 96</b> 2 doors H 96</p>	L 60	E2020600	260	306	—		
	L 80	E2020800	298	355	—		
	*L 90	E2020900	315	375	—		
			+100	+130			
<p><b>*mag. ante con decoro metallico</b> surcharge for doors with metallic decor</p>							
 <p><b>fascia tamponamento</b> <b>L da 3 a 10</b> filler panel size from 3 to 10</p>	H 60	E2790000	80	94	—		
	H 72	E2800000	80	94	—		
	H 96	E2810000	99	114	—		

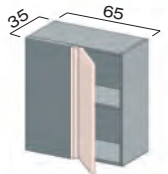
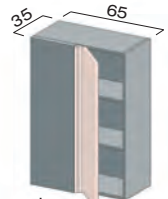



		COD.	FASCIA A K70	FASCIA B K70				
 <p><b>1 anta vetro H 36</b> 1 glass door H 36</p>								
	L 45	E1030451/2	168	198				
	L 60	E1030601/2	181	213				
 <p><b>1 anta vetro H 48</b> 1 glass door H 48</p>								
	L 45	E1040451/2	192	229				
	L 60	E1040601/2	204	240				
 <p><b>1 anta vetro H 72</b> 1 glass door H 72</p>								
	L 45	E1010451/2	197	232				
	L 60	E1010601/2	230	273				
 <p><b>1 anta vetro H 96</b> 1 glass door H 96</p>								
	L 45	E1020451/2	249	295				
 <p><b>1 anta inserto vetro H 96</b>  <b>N.B.: non disponibile per le finiture grigio reale (opz.2454) e bianco artico (opz.2491)</b>                      1 door glass insert H 96                      Note: not available for royal grey (opt.2454) and arctic white (opt.2491)</p>								
	L 45	E1050451/2	258	310				

		COD.	FASCIA A K70	FASCIA B K70				
 <p><b>2 ante vetro H 36</b> 2 glass doors H 36</p>								
	L 90	E1030900	305	365				
 <p><b>2 ante vetro H 48</b> 2 glass doors H 48</p>								
	L 90	E1040900	343	417				
 <p><b>2 ante vetro H 72</b> 2 glass doors H 72</p>								
	L 90	E1010900	356	426				
 <p><b>2 ante vetro H 96</b> 2 glass doors H 96</p>								
	L 90	E1020900	452	545				
 <p><b>2 ante inserto vetro H 96</b> <b>N.B.: non disponibile per le finiture grigio reale (opz.2454) e bianco artico (opz.2491)</b> 2 doors glass insert H 96 Note: not available for royal grey (opt.2454) and arctic white (opt.2491)</p>								
	L 90	E1050900	470	573				
 <p><b>pensile H 72</b> <b>frontale fisso sagomato H 18</b> <b>2 ante sagomate</b> wall unit H 72 fixed contoured front H 18 2 shaped doors</p>								
	L 90	E2014900	383	469				



		COD.	FASCIA A K70	FASCIA B K70	MAGG. LAVAGNA		
 <p><b>angolo H 72</b> <b>1 anta diagonale</b> corner unit H 72 1 diagonal door</p>	65X65	E2400651/2	214	236	+173		
			+15	+20			
			+50	+65			
	<p><b>mag.anta con intarsio</b> surcharge for door with inlaid</p> <p><b>mag.anta con decoro metallico</b> surcharge for door with metallic decor</p>						
 <p><b>angolo H 96</b> <b>1 anta diagonale</b> corner unit H 96 1 diagonal door</p>	65X65	E2410651/2	261	291	—		
			+50	+65			
	<p><b>mag.anta con decoro metallico</b> surcharge for door with metallic decor</p>						
 <p><b>angolo H 72</b> <b>2 ante a libretto</b> <b>N.B.: non si effettuano fuori squadra</b> corner unit H 72 2 folding doors Note: out-of-plumb units unavailable</p>	65X65	E2450651/2	299	338	—		
 <p><b>angolo H 96</b> <b>2 ante a libretto</b> <b>N.B.: non si effettuano fuori squadra</b> corner unit H 96 2 folding doors Note: out-of-plumb units unavailable</p>	65X65	E2460651/2	367	417	—		
 <p><b>angolo H 72</b> <b>1 anta</b> <b>N.B.: fuori squadra realizzabili da 88° a 94°</b> corner unit H 72 1 door Note: out-of-plumb units available from 88° to 94°</p> <p>verso dx RH version</p>	65X35	E2491651/2	231	264	—		
 <p><b>angolo H 96</b> <b>1 anta</b> <b>N.B.: fuori squadra realizzabili da 88° a 94°</b> corner unit H 96 1 door Note: out-of-plumb units available from 88° to 94°</p> <p>verso dx RH version</p>	65X35	E2495651/2	285	323	—		

			COD.	FASCIA A K70	FASCIA B K70	MAGG. LAVAGNA				
 <p><b>copriboiler H 72</b> <b>1 anta</b> boiler housing H 72 1 door</p>	P 33,4 *L 60		E2150601/2	170	201	+262				
		L 65		E2150651/2	183	218	—			
	P 47,4 *L 60			E2160601/2	209	242	+262			
		L 65		E2160651/2	220	257	—			
	P 59,9 *L 60			E2170601/2	209	242	+262			
		L 65		E2170651/2	220	257	—			
			<b>*mag.anta con intarsio</b> surcharge for door with inlaid		+15	+20				
			<b>*mag.anta con decoro metallico</b> surcharge for door with metallic decor		+50	+65				
 <p><b>copriboiler H 96</b> <b>1 anta</b> boiler housing H 96 1 door</p>	P 33,4 *L 60		E2210601/2	210	249	—				
		L 65		E2210651/2	218	262	—			
	P 47,4 *L 60			E2220601/2	254	294	—			
		L 65		E2220651/2	269	316	—			
	P 59,9 *L 60			E2230601/2	254	294	—			
		L 65		E2230651/2	269	316	—			
			<b>*mag.anta con decoro metallico</b> surcharge for door with metallic decor		+50	+65				
	 <p><b>mobile cantinetta</b> <b>con portabottiglie metallico</b> <b>N.B.: non disponibile per le finiture grigio reale (opz.2454) e bianco artico (opz.2491)</b> wine cellar unit with metal bottle rack Note: not available for royal grey (opt.2454) and arctic white (opt.2491)</p>	L 45		E2953450	698	738	—			
 <p><b>mobile cantinetta</b> <b>con portabottiglie metallico</b> <b>N.B.: non disponibile per le finiture grigio reale (opz.2454) e bianco artico (opz.2491)</b> wine cellar unit with metal bottle rack Note: not available for royal grey (opt.2454) and arctic white (opt.2491)</p>		L 60		E2953600	818	872	—			
	 <p><b>jolly pensile H 72</b> <b>L da 10 a 30</b> jolly wall unit H 72 size from 10 to 30</p>	in nobilitato melamine coated		E2700000	59	59	—			
impiallacciato veneered				E2720000	258	268	—			
 <p><b>jolly pensile H 96</b> <b>L da 10 a 30</b> jolly wall unit H 96 size from 10 to 30</p>	in nobilitato melamine coated		E2710000	68	68	—				
	impiallacciato veneered			E2730000	308	325	—			

		COD.	FASCIA A K70	FASCIA B K70			
 <p><b>terminale 33,6X33,6 H 72</b> <b>1 anta vetro tipo "C"</b> <b>N.B.: non disponibile per le finiture grigio reale (opz.2454) e bianco artico (opz.2491)</b> end unit 33,6X33,6 H 72 1 glass door type "C" <b>Note: not available for royal grey (opt.2454) and arctic white (opt.2491)</b></p>							
	H 72	E1640311/2	292	354			
 <p><b>terminale 33,6X33,6 H 96</b> <b>1 anta vetro tipo "C"</b> <b>N.B.: non disponibile per le finiture grigio reale (opz.2454) e bianco artico (opz.2491)</b> end unit 33,6X33,6 H 96 1 glass door type "C" <b>Note: not available for royal grey (opt.2454) and arctic white (opt.2491)</b></p>							
	H 96	E1650311/2	353	428			
 <p><b>terminale 31x31 H 72 a giorno tipo "C"</b> <b>1 ripiano</b> open end unit 31x31 H 72 type "C" 1 shelf</p>							
	in nobilitato melamine coated	E2640310	64	64			
	impiallacciato veneered	E2641310	271	288			
 <p><b>terminale 31x31 H 96 a giorno tipo "C"</b> <b>2 ripiani</b> open end unit 31x31 H 96 type "C" 2 shelves</p>							
	in nobilitato melamine coated	E2650310	81	81			
	impiallacciato veneered	E2651310	311	328			

# PENSILI A GIORNO IMPIALLACCIATI

VENEERED OPEN WALL UNITS

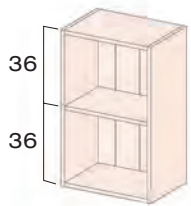
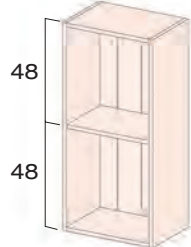
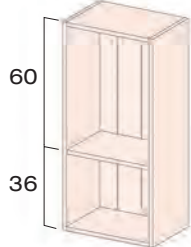
		COD.	FASCIA A K70	FASCIA B K70				
 <p><b>pensile a giorno impiallacciato</b>  <b>H 72 prof.33,4 sp.2,2 con ripiano</b>  <b>fisso e schienale dogato</b>                      veneered open wall unit                      H 72 D 33,4 th. 2,2 with fixed shelf                      and grooved back panel</p>	L 60	E290660L	475	503				
	L 90	E290690L	615	652				
	L 120	E290720L	729	773				
 <p><b>pensile a giorno impiallacciato</b>  <b>H 96 prof.33,4 sp.2,2 con ripiano</b>  <b>fisso e schienale dogato</b>                      veneered open wall unit                      H 96 D 33,4 th. 2,2 with fixed shelf                      and grooved back panel</p>	L 60	E290760P	552	585				
	L 90	E290790P	695	737				
	L 120	E290820P	742	787				
 <p><b>pensile a giorno impiallacciato</b>  <b>H 96 prof.33,4 sp.2,2 con ripiano</b>  <b>fisso e schienale dogato</b>                      veneered open wall unit                      H 96 D 33,4 th. 2,2 with fixed shelf                      and grooved back panel</p>	L 60	E290760Q	552	585				
	L 90	E290790Q	695	737				
	L 120	E290820Q	742	787				

# PENSILI RIBALTA CHIUSURA AMMORTIZZATA

FLAP DOOR WALL UNITS BLUMOTION CLOSING SYSTEM

## PENSILE CON APERTURA A RIBALTA



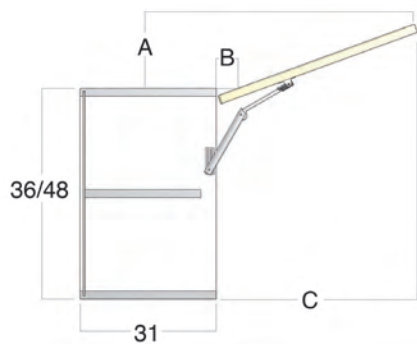

Le ante aprendosi verso l'alto consentono di avere un' ampia visione d'insieme all'interno del mobile. In questo modo è possibile un comodo accesso agli oggetti contenuti al suo interno e, dal punto di vista ergonomico, molto vantaggioso. La regolazione della forza di apertura può essere impostata in modo esatto in base al peso del frontale. Grazie all'arresto progressivo le ante si fermano in qualsiasi posizione; in questo modo la maniglia è sempre facilmente raggiungibile. La chiusura è ammortizzata di serie.

### WALL UNIT WITH FLAP DOOR

The doors that open upwards guarantee ample overall visibility inside the cabinet. In this way, all objects housed inside the cabinet can be comfortably accessed, making the system highly advantageous from an ergonomic perspective. The opening force can be adjusted precisely according to the weight of the front. The doors stop in any position thanks to the gradual stopping movement; in this way, the handle is always easily accessible. The closing movement is cushioned standard

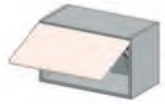
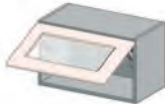

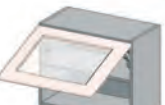
	A	B	C
H 36	7	4	37
H 48	11	4	49

		COD.	FASCIA A K70	FASCIA B K70	MAGG. LAVAGNA			
 <p><b>anta ribalta H 36</b> flap door H 36</p>	L 45	E2100450	143	161	+80			
	L 60	E2100600	146	164	+106			
	L 65	E2100650	163	186	—			
	L 90	E2100900	188	212	+173			
				+15	+20			
				+50	+65			
 <p><b>anta vetro ribalta H 36</b> glass flap door H 36</p>	L 45	E1100450	194	223	—			
	L 60	E1100600	200	230	—			
	L 90	E1100900	256	297	—			
 <p><b>anta ribalta H 48</b> flap door H 48</p>	L 45	E2120450	177	197	—			
	L 60	E2120600	199	220	+157			
	L 65	E2120650	215	241	—			
	L 90	E2120900	240	273	+251			
 <p><b>anta vetro ribalta H 48</b> glass flap door H 48</p>	L 45	E1120450	222	258	—			
	L 60	E1120600	250	284	—			
	L 90	E1120900	311	359	—			
 <p><b>pensile H 72 vano a giorno con cornice sagomata 1 anta a ribalta H 36</b> wall unit H 72 open unit with shaped frame 1 flap door H 36</p>	L 60	E2081600	246	283	+106			
	L 90	E2081900	257	298	+173			
				+15	+20			
				+50	+65			
 <p><b>pensile H 72 vano a giorno con cornice sagomata 1 anta vetro a ribalta H 36</b> wall unit H 72 open unit with shaped frame 1 glass flap door H 36</p>	L 60	E2082600	299	349	—			
	L 90	E2082900	326	384	—			

# PENSILI APERTURA VERTICALE OBLIQUA CHIUSURA BLUMOTION

WALL UNITS VERTICAL OBLIQUE OPENING AND BLUMOTION CLOSING SYSTEM

## APERTURA VERTICALE OBLIQUA



I pensili con questo tipo di meccanismo necessitano per l'apertura di poco spazio libero sopra il mobile grazie al movimento basculante dell'anta che si apre senza difficoltà applicando poca forza anche in presenza di frontali pesanti. Con l'arresto progressivo le ante si fermano in qualsiasi posizione; in questo modo la maniglia è sempre facilmente raggiungibile. La chiusura è ammortizzata ed è possibile regolare la forza di tenuta in base al peso del frontale.

### VERTICAL OPENING OBLIQUE

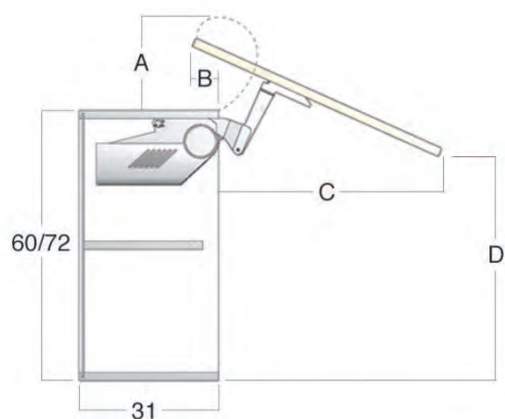
Wall units that mount this type of mechanism require little clearance above the cabinet thanks to the swivelling movement of the door that can be easily opened by applying slight pressure, even with heavy fronts. The doors stop in any position thanks to the gradual stopping movement; in this way, the handle is always easily accessible. The closing movement is cushioned and the closing force can be adjusted according to the weight of the front door.



	A	B	C	D
H 60	18	9,6	46,5	53,5
H 72	18	9,6	57	61

	COD.	FASCIA A K70	FASCIA B K70	MAGG. LAVAGNA			
<p><b>anta apertura verticale obliqua H 60</b> door with oblique vertical opening H 60</p> 							
	L 60 E2135600	319	345	—			
<p><b>anta apertura verticale obliqua H 72</b> door with oblique vertical opening H 72</p> 							
	*L 45 E2130450	298	320	+173			
	*L 60 E2130600	328	357	+262			
	L 65 E2130650	341	373	—			
	*mag.anta con intarsio surcharge for door with inlaid		+15	+20			
	*mag.anta con decoro metallico surcharge for door with metallic decor		+50	+65			
<p><b>anta apertura verticale obliqua H 72</b> door with oblique vertical opening H 72</p> 							
	L 45 E1200450	357	392	—			
	L 60 E1200600	389	433	—			



# PENSILI APERTURA A PACCHETTO

WALL UNITS FOLDING DOORS

## PENSILE CON APERTURA ANTE A PACCHETTO

Il meccanismo d'apertura ante a pacchetto è idoneo sia sul pensile H 72 che H 96; la regolazione della forza di apertura può essere impostata in modo esatto in base ai pesi dei frontali, la chiusura è ammortizzata e la cerniera centrale clip si contraddistingue per l'innovativa tecnologia che garantisce la sicurezza per le dita.

WALL UNIT WITH LIFT-UP FOLDING DOORS

The lift-up folding door opening mechanism is suitable for wall units with H 72 or H 96; the opening force can be adjusted precisely according to the weight of the fronts, while the closing movement is cushioned and the central clip-on hinge features innovative technology for safeguarding the fingers.



H 72



H 96

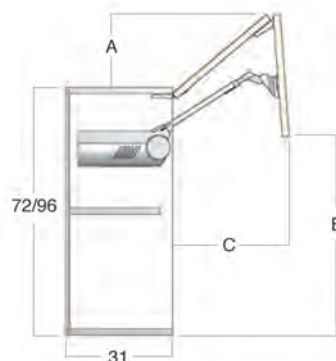

	A	B	C
H 72	16,5	54	41
H 96	20	69	53

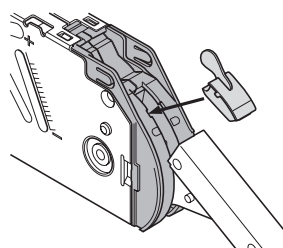
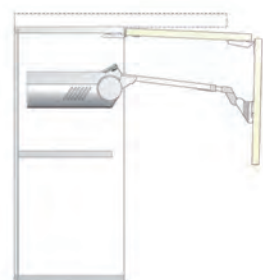

### SCHEMA MONTAGGIO LIMITATORE LIMITER INSTALLATION DIAGRAM





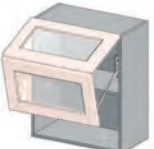
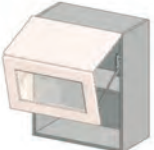
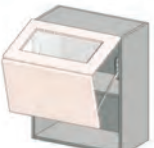



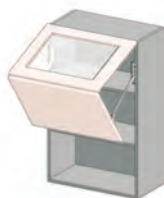

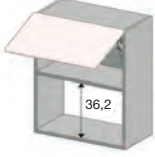
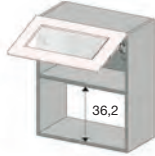
Per evitare l'interferenza dell'anta in fase di apertura con cornici o mensole, si può richiedere il limitatore dell'angolo di apertura cod. 5620005 € 10



In order to avoid that the door interferes with cornices or shelves during the opening movement, it is possible to request an opening angle limiter: code 5620005 € 10







		COD.	FASCIA A K70	FASCIA B K70	MAGG. LAVAGNA		
 <p><b>pensile H 72 apertura a pacchetto 2 ante H 36</b> wall unit H 72 lift-up folding door 2 doors H 36</p>	L 45	E2070450	356	391	—		
	L 60	E2070600	373	410	—		
	L 65	E2070650	390	436	—		
	L 90	E2070900	418	467	—		
 <p><b>pensile H 72 apertura a pacchetto 2 ante vetro H 36</b> wall unit H 72 lift-up folding door 2 glass doors H 36</p>	L 60	E1070600	477	539	—		
	L 90	E1070900	554	635	—		
 <p><b>pensile H 72 apertura a pacchetto 1 anta chiusa superiore H 36 1 anta vetro inferiore H 36</b> wall unit H 72 lift-up folding door 1 full upper door H 36 1 glass lower door H 36</p>	L 60	E2075600	425	474	—		
	L 90	E2075900	486	551	—		
 <p><b>pensile H 72 apertura a pacchetto 1 anta vetro superiore H 36 1 anta chiusa inferiore H 36</b> wall unit H 72 lift-up folding door 1 glass upper door H 36 1 full lower door H 36</p>	L 60	E2077600	425	474	+106		
	L 90	E2077900	486	551	+173		







		COD.	FASCIA A K70	FASCIA B K70	MAGG. LAVAGNA			
 <p><b>pensile H 96 apertura a pacchetto 2 ante H 48</b> wall unit H 96 lift-up folding door 2 doors H 48</p>	L 45	E2090450	402	440	—			
	L 60	E2090600	424	467	—			
	L 90	E2090900	499	564	—			
 <p><b>pensile H 96 apertura a pacchetto 2 ante vetro H 48</b> wall unit H 96 lift-up folding door 2 glass doors H 48</p>	L 45	E1090450	499	569	—			
	L 60	E1090600	524	592	—			
	L 90	E1090900	630	726	—			
 <p><b>pensile H 96 apertura a pacchetto 1 anta chiusa superiore H 48 1 anta vetro inferiore H 48</b> wall unit H 96 lift-up folding door 1 full upper door H 48 1 glass lower door H 48</p>	L 45	E2092450	450	505	—			
	L 60	E2092600	474	529	—			
	L 90	E2092900	564	645	—			
 <p><b>pensile H 96 apertura a pacchetto 1 anta vetro superiore H 48 1 anta chiusa inferiore H 48</b> wall unit H 96 lift-up folding door 1 glass upper door H 48 1 full lower door H 48</p>	L 45	E2096450	450	505	—			
	L 60	E2096600	474	529	+157			
	L 90	E2096900	564	645	+251			

	COD.	FASCIA A K70	FASCIA B K70	MAGG. LAVAGNA			
<p><b>pensile H 72</b> <b>1 anta ribalta H 36</b> <b>vano per micro Whirlpool</b> wall unit H 72 1 flap door H 36 housing for Whirlpool microwave</p> 	L 60	EPM20600	184	202	+106		
			+15	+20			
			+50	+65			
<p><b>pensile H 72</b> <b>1 anta vetro ribalta H 36</b> <b>vano per micro Whirlpool</b> wall unit H 72 1 glass flap door H 36 housing for Whirlpool microwave</p> 	L 60	EPM10600	232	263	—		
<p><b>pensile H 96</b> <b>1 anta H 60</b> <b>vano per micro Whirlpool</b> wall unit H 96 1 door H 60 housing for Whirlpool microwave</p> 	L 60	EPM25601/2	205	231	—		







		COD.	FASCIA A K70	FASCIA B K70				
 <p><b>soprapensile H 36</b> <b>1 ante</b> top unit H 36 1 door</p>	L 45	E2063451/2	168	185				
	L 60	E2063601/2	163	182				
			+15	+20				
			+50	+65				
			<p><b>mag.anta con intarsio</b> surcharge for door with inlaid</p> <p><b>mag.anta con decoro metallico</b> surcharge for door with metallic decor</p>					
 <p><b>soprapensile H 48</b> <b>1 ante</b> top unit H 48 1 door</p>	L 45	E2064451/2	208	227				
	L 60	E2064601/2	208	230				
 <p><b>soprapensile H 60</b> <b>1 ante</b> top unit H 60 1 door</p>	L 45	E2065451/2	209	229				
	L 60	E2065601/2	219	245				
 <p><b>soprapensile H 36</b> <b>2 ante</b> top unit H 36 2 doors</p>	L 90	E2063900	247	282				
			+30	+40				
			+100	+130				
			<p><b>mag.ante con intarsio</b> surcharge for doors with inlaid</p> <p><b>mag.ante con decoro metallico</b> surcharge for doors with metallic decor</p>					
 <p><b>soprapensile H 48</b> <b>2 ante</b> top unit H 48 2 doors</p>	L 90	E2064900	302	341				
	 <p><b>soprapensile H 60</b> <b>2 ante</b> top unit H 60 2 doors</p>	L 90	E2065900	306	347			





		COD.	FASCIA A K70	FASCIA B K70				
 <p><b>soprapensile H 36</b> <b>1 anta vetro ribalta</b> top unit H 36 1 glass flap door</p>	L 60	E1101600	210	241				
	L 90	E1101900	256	297				
 <p><b>soprapensile H 48</b> <b>1 anta ribalta</b> top unit H 48 1 flap door</p>	L 60	E2128600	209	230				
	L 90	E2128900	261	293				
 <p><b>soprapensile H 48</b> <b>1 anta vetro ribalta</b> top unit H 48 1 glass flap door</p>	L 60	E1128600	297	331				
	L 90	E1128900	362	411				



		COD.	FASCIA A K70	FASCIA B K70	MAGG. LAVAGNA		
 <p><b>1 anta H 60</b> 1 door H 60</p>	L 45	E3060451/2	159	180	—		
	L 60	E3060601/2	179	205	—		
 <p><b>1 anta H 72</b> 1 door H 72</p>	L 45	E3010451/2	166	188	+173		
	L 60	E3010601/2	189	218	+262		
			+15	+20			
			+50	+65			
 <p><b>1 anta H 96</b> 1 door H 96</p>	L 45	E3020451/2	202	232	—		
	L 60	E3020601/2	234	271	—		
			+50	+65			
 <p><b>1 anta vetro H 72</b> 1 glass door H 72</p>	L 45	E3210451/2	218	253	—		
	L 60	E3210601/2	307	321	—		
 <p><b>1 anta vetro H 96</b> 1 glass door H 96</p>	L 45	E3220451/2	270	317	—		
 <p><b>1 anta inserto vetro H 96</b> <b>N.B.: non disponibile per le finiture grigio reale (opz.2454) e bianco artico (opz.2491)</b> 1 door glass insert H 96 <b>Note: not available for royal grey (opt.2454) and arctic white (opt.2491)</b></p>	L 45	E3050451/2	280	332	—		

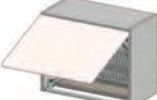
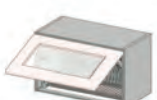



	COD.	FASCIA A K70	FASCIA B K70	MAGG. LAVAGNA		
 <p><b>2 ante H 60</b> 2 doors H 60</p>	L 90	E3060900	270	311	—	
	<p><b>2 ante H 72</b> 2 doors H 72</p> 					
	L 60	E3010600	250	287	—	
	L 80	E3010800	273	316	—	
	*L 90	E3010900	282	327	+346	
			+30	+40		
			+100	+130		
<p><i>*mag. ante con intarsio</i> surcharge for doors with inlaid</p> <p><i>*mag. ante con decoro metallico</i> surcharge for doors with metallic decor</p>						
 <p><b>2 ante H 96</b> 2 doors H 96</p>	L 60	E3020600	288	334	—	
	L 80	E3020800	328	384	—	
	*L 90	E3020900	345	405	—	
			+100	+130		
	<p><i>*mag. ante con decoro metallico</i> surcharge for doors with metallic decor</p>					
 <p><b>2 ante vetro H 72</b> 2 glass doors H 72</p>	L 90	E3210900	388	458	—	
	 <p><b>2 ante vetro H 96</b> 2 glass doors H 96</p>	L 90	E3220900	483	576	—
 <p><b>2 ante inserto vetro H 96</b> <i>N.B.: non disponibile per le finiture grigio reale (opz.2454) e bianco artico (opz.2491)</i> 2 doors glass insert H 96 Note: not available for royal grey (opt.2454) and arctic white (opt.2491)</p>		L 90	E3050900	501	605	—

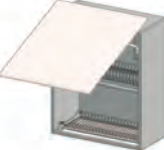
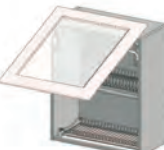







		COD.	FASCIA A K70	FASCIA B K70	MAGG. LAVAGNA		
 <p><b>scolapiatti H 72</b> <b>frontale fisso sagomato H 18</b> <b>2 ante sagomate</b> plate rack units H 72 fixed contoured front H 18 2 shaped doors</p>							
	L 90	E3014900	426	512	—		
 <p><b>angolo H 72</b> <b>1 anta diagonale</b> <b>N.B.: non si effettuano fuori squadra</b> corner unit H 72 1 diagonal door Note: out-of-plumb units unavailable</p>	65X65	E3400651/2	334	357	+173		
			+15	+20			
			+50	+65			
 <p><b>angolo H 96</b> <b>1 anta diagonale</b> <b>N.B.: non si effettuano fuori squadra</b> corner unit H 96 1 diagonal door Note: out-of-plumb units unavailable</p>	65X65	E3410651/2	383	413	—		
			+50	+65			
 <p><b>angolo H 72</b> <b>2 ante a libretto</b> <b>N.B.: non si effettuano fuori squadra</b> corner unit H 72 2 folding doors Note: out-of-plumb units unavailable</p>	65X65	E3450651/2	409	448	—		
 <p><b>angolo H 96</b> <b>2 ante a libretto</b> <b>N.B.: non si effettuano fuori squadra</b> corner unit H 96 2 folding doors Note: out-of-plumb units unavailable</p>	65X65	E3460651/2	481	531	—		
 <p><b>Maggiorazione</b> <b>kit luce LED DUAL COLOR calda (2700K) e naturale (4200K)</b> <b>interruttore ON/OFF "Touch" a sfioramento con alimentatore incluso</b> Surcharge DUAL COLOR LED light kit warm (2700K) and natural (4200K) "Soft Touch" switch ON/OFF with power supplier</p>		opz.005					
	L 45		+100	+100			
	L 60		+105	+105			
	L 65		+105	+105			
	L 80		+115	+115			
	L 90		+115	+115			

		COD.	FASCIA A K70	FASCIA B K70	MAGG. LAVAGNA		
 <p><b>anta ribalta H 36</b> <b>griglie orion grau e raccogligocce plastica</b> flap door H 36 orion grau grilles and plastic drip tray</p>	L 60	E3100600	161	180	+106		
	L 90	E3100900	209	233	+173		
			+15	+20			
			+50	+65			
		<p><b>mag.anta con intarsio</b> surcharge for door with inlaid</p> <p><b>mag.anta con decoro metallico</b> surcharge for door with metallic decor</p>					
 <p><b>anta ribalta H 48</b> <b>griglie orion grau e raccogligocce plastica</b> flap door H 48 orion grau grilles and plastic drip tray</p>	L 60	E3120600	204	226	+157		
	L 90	E3120900	250	282	+251		
 <p><b>anta vetro ribalta H 36</b> <b>griglie orion grau e raccogligocce plastica</b> glass flap door H 36 orion grau grilles and plastic drip tray</p>	L 60	E3130600	215	245	—		
	L 90	E3130900	278	318	—		
 <p><b>anta vetro ribalta H 48</b> <b>griglie orion grau e raccogligocce plastica</b> glass flap door H 48 orion grau grilles and plastic drip tray</p>	L 60	E3140600	256	290	—		
	L 90	E3140900	316	364	—		
 <p><b>scolapiatti H 72 vano a giorno</b> <b>con cornice sagomata</b> <b>1 anta ribalta H 36</b> <b>griglie orion grau e raccogligocce plastica</b> plate rack unit H 72 open unit with shaped frame 1 flap door H 36 orion grau grilles and plastic drip tray</p>	L 60	E3091600	258	295	+106		
	L 90	E3091900	274	315	+173		
			+15	+20			
			+50	+65			
		<p><b>mag.anta con intarsio</b> surcharge for door with inlaid</p> <p><b>mag.anta con decoro metallico</b> surcharge for door with metallic decor</p>					
 <p><b>scolapiatti H 72 vano a giorno</b> <b>con cornice sagomata</b> <b>1 anta vetro a ribalta H 36</b> <b>griglie orion grau e raccogligocce plastica</b> plate rack unit H 72 open unit with shaped frame 1 glass flap door H 36 orion grau grilles and plastic drip tray</p>	L 60	E3092600	311	361	—		
	L 90	E3092900	348	406	—		

		COD.	FASCIA A K70	FASCIA B K70	MAGG. LAVAGNA		
 <p><b>anta apertura verticale obliqua H 60</b> <b>griglie orion grau e raccogliocce plastica</b> door with oblique vertical opening H 60 stainless steel grilles and drip tray</p>							
	L 60	E3123600	326	352	—		
 <p><b>anta apertura verticale obliqua H 72</b> <b>griglie orion grau e raccogliocce plastica</b> door with oblique vertical opening H 72 stainless steel grilles and drip tray</p>							
	L 60	E3125600	340	369	+262		
			+15	+20			
			+50	+65			
<p><b>mag.anta con intarsio</b> surcharge for door with inlaid</p> <p><b>mag.anta con decoro metallico</b> surcharge for door with metallic decor</p>							
 <p><b>anta vetro apertura verticale obliqua H 72</b> <b>griglie orion grau e raccogliocce plastica</b> glass door with vertical oblique opening H 72 stainless steel grilles and drip tray</p>							
	L 60	E3200600	402	445	—		
 <p><b>Maggiorazione</b> <b>kit luce LED DUAL COLOR calda (2700K) e naturale (4200K)</b> <b>interruttore ON/OFF "Touch" a sfioramento con alimentatore incluso</b> <b>Surcharge</b> DUAL COLOR LED light kit warm (2700K) and natural (4200K) "Soft Toouch" switch ON/OFF with power supplier</p>							
		opz.005					
	L 45		+100	+100			
	L 60		+105	+105			
	L 65		+105	+105			
	L 80		+115	+115			
L 90		+115	+115				

		COD.	FASCIA A K70	FASCIA B K70	MAGG. LAVAGNA		
 <p><b>scolapiatti H 72 apertura a pacchetto 2 ante H 36</b> <b>griglie orion grau e raccogliocce plastica</b> plate rack unit H 72 lift-up folding door 2 doors H 36 orion grau grilles and plastic drip tray</p>	L 45	E3081450	369	404	—		
	L 60	E3081600	385	422	—		
	L 90	E3081900	434	482	—		
 <p><b>scolapiatti H 72 apertura a pacchetto 2 ante vetro H 36</b> <b>griglie orion grau e raccogliocce plastica</b> plate rack unit H 72 lift-up folding door 2 glass doors H 36 orion grau grilles and plastic drip tray</p>	L 60	E3270600	489	551	—		
	L 90	E3270900	569	650	—		
 <p><b>scolapiatti H 72 apertura a pacchetto 1 anta chiusa superiore H 36 1 anta vetro inferiore H 36</b> <b>griglie orion grau e raccogliocce plastica</b> plate rack unit H 72 lift-up folding door 1 full upper door H 36 1 glass lower door H 36 orion grau grilles and plastic drip tray</p>	L 60	E3085600	437	486	—		
	L 90	E3085900	501	566	—		
 <p><b>scolapiatti H 72 apertura a pacchetto 1 anta vetro superiore H 36 1 anta chiusa inferiore H 36</b> <b>griglie orion grau e raccogliocce plastica</b> plate rack unit H 72 lift-up folding door 1 glass upper door H 36 1 full lower door H 36 orion grau grilles and plastic drip tray</p>	L 60	E3087600	437	486	+106		
	L 90	E3087900	501	566	+173		

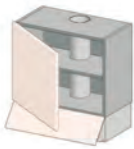
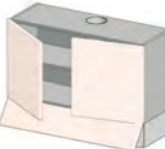
		COD.	FASCIA A K70	FASCIA B K70	MAGG. LAVAGNA		
 <p><b>scolapiatti H 96 apertura a pacchetto 2 ante H 48</b> <b>griglie orion grau e raccogliocce plastica</b> plate rack unit H 96 lift-up folding door 2 doors H 48 orion grau grilles and plastic drip tray</p>	L 45	E3094450	415	454	—		
	L 60	E3094600	436	479	—		
	L 90	E3094900	515	579	—		
 <p><b>scolapiatti H 96 apertura a pacchetto 2 ante vetro H 48</b> <b>griglie orion grau e raccogliocce plastica</b> plate rack unit H 96 lift-up folding door 2 glass doors H 48 orion grau grilles and plastic drip tray</p>	L 60	E3290600	536	604	—		
	L 90	E3290900	645	741	—		
 <p><b>scolapiatti H 96 apertura a pacchetto 1 anta chiusa superiore H 48 1 anta vetro inferiore H 48</b> <b>griglie orion grau e raccogliocce plastica</b> plate rack unit H 96 lift-up folding door 1 full upper door H 48 1 glass lower door H 48 orion grau grilles and plastic drip tray</p>	L 60	E3095600	490	546	—		
	L 90	E3095900	580	660	—		
 <p><b>scolapiatti H 96 apertura a pacchetto 1 anta vetro superiore H 48 1 anta chiusa inferiore H 48</b> <b>griglie orion grau e raccogliocce plastica</b> plate rack unit H 96 lift-up folding door 1 glass upper door H 48 1 full lower door H 48 orion grau grilles and plastic drip tray</p>	L 60	E3097600	490	546	+157		
	L 90	E3097900	580	660	+251		

		COD.	FASCIA A K70	FASCIA B K70	MAGG. LAVAGNA		
 <p><b>cappa estraibile 2 motori portata 275 m³/h con laterali in metallo, 1 anta</b>  <b>N.B.: posizionare la cappa ad una distanza non inferiore ai 65 cm dal piano cottura</b></p> <p>slide-out hood 2 motors air flow rate 275 m³/h with metal sides, 1 door  <b>Note: position the hood at least 65 cm from the cooker hob</b></p>	<b>H 63 L 60</b>	E3600601/2	251	286	—		
	<b>H 87 L 60</b>	E3610601/2	275	317	—		
	<b>n° 2 filtri carbone attivo</b> 2 active carbon filters		+24	+24			
 <p><b>cappa estraibile 2 motori portata 275 m³/h con laterali in metallo, 2 ante</b>  <b>N.B.: posizionare la cappa ad una distanza non inferiore ai 65 cm dal piano cottura</b></p> <p>slide-out 2 motors air flow rate 275 m³/h with metal sides, 2 doors  <b>Note: position the hood at least 65 cm from the cooker hob</b></p>	<b>H 63 L 90</b>	E3600900	357	411	—		
	<b>H 87 L 90</b>	E3610900	377	437	—		
	<b>n° 2 filtri carbone attivo</b> 2 active carbon filters		+24	+24			
 <p><b>cappa "Mod. F" integrata totale con frontalino vetro estraibile portata 390 m³/h con faretti a led 1 anta</b>  <b>N.B.: posizionare la cappa ad una distanza non inferiore ai 55 cm dal piano cottura</b></p> <p>"Mod. F" fully integrated hood with glass pull-out frontal panel air flow rate 390 m³/h, with led lights 1 door  <b>Note: position the hood at least 55 cm from the cooker hob</b></p>	<b>H 60 L 60</b>	EPC90461/2	505	531	—		
	<b>*H 72 L 60</b>	EPC90561/2	514	543	+262		
	<b>mag.anta H 72 con intarsio</b> surcharge for door H 72 with inlaid		+15	+20			
	<b>*H 96 L 60</b>	EPC90661/2	555	591	—		
	<b>n° 2 filtri carbone attivo</b> 2 active carbon filters	08750894	31	31			
	<b>*mag.anta con decoro metallico</b> surcharge for door with metallic decor		+50	+65			
 <p><b>cappa "Mod. F" integrata totale con frontalino vetro estraibile portata 415 m³/h con faretti a led 2 ante</b>  <b>N.B.: posizionare la cappa ad una distanza non inferiore ai 55 cm dal piano cottura</b></p> <p>"Mod. F" fully integrated hood with glass pull-out front panel air flow rate 415 m³/h with led lights 2 doors  <b>Note: position the hood at least 55 cm from the cooker hob</b></p>	<b>H 60 L 90</b>	EPC90490	611	652	—		
	<b>*H 72 L 90</b>	EPC90590	621	665	+346		
	<b>mag.ante H 72 con intarsio</b> surcharge for doors H 72 with inlaid		+30	+40			
	<b>*H 96 L 90</b>	EPC90690	684	744	—		
	<b>n° 2 filtri carbone attivo</b> 2 active carbon filters	08750894	31	31			
	<b>*mag.ante con decoro metallico</b> surcharge for doors with metallic decor		+100	+130			

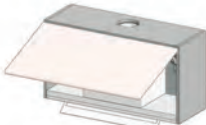
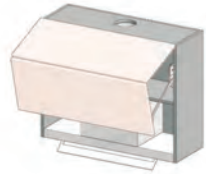
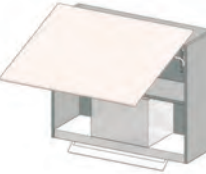
		COD.	FASCIA A K70	FASCIA B K70	MAGG. LAVAGNA		
<p><b>cappa "Mod. F" integrata totale con frontalino vetro estraibile portata 390 m³/h con faretti a led</b>  <b>1 anta apertura a ribalta</b>  <b>N.B.: posizionare la cappa ad una distanza non inferiore ai 55 cm dal piano cottura</b></p> <p>"Mod. F" fully integrated hood with glass pull-out front panel                      air flow rate 390 m³/h with led lights                      1 flap door  <b>Note: position the hood at least 55 cm from the cooker hob</b></p> 							
	<b>*H 36 L 60</b>	EPC80260	501	519	+106		
	<b>*H 36 L 90</b>	EPC80290	567	591	+173		
	<b>H 48 L 60</b>	EPC80360	551	573	+157		
	<b>H 48 L 90</b>	EPC80390	615	647	+251		
	<b>n° 2 filtri carbone attivo</b> 2 active carbon filters	08750894	31	31			
<b>*mag.anta con intarsio</b> surcharge for door with inlaid		+15	+20				
<b>*mag.anta con decoro metallico</b> surcharge for door with metallic decor		+50	+65				
<p><b>cappa "Mod. F" integrata totale con frontalino vetro estraibile portata 390 m³/h con faretti a led</b>  <b>2 ante apertura a pacchetto</b>  <b>N.B.: posizionare la cappa ad una distanza non inferiore ai 55 cm dal piano cottura</b></p> <p>"Mod. F" fully integrated hood with glass pull-out front panel                      air flow rate 390 m³/h with led lights                      2 lift-up folding doors  <b>Note: position the hood at least 55 cm from the cooker hob</b></p> 							
	<b>*H 72 L 60</b>	EPC83560	711	748	—		
	<b>*H 72 L 90</b>	EPC83590	781	830	—		
	<b>H 96 L 60</b>	EPC83660	759	802	—		
	<b>H 96 L 90</b>	EPC83690	859	924	—		
	<b>n° 2 filtri carbone attivo</b> 2 active carbon filters	08750894	31	31			
<p><b>cappa "Mod.F" integrata totale con frontalino estraibile vetro portata 390 m³/h</b>  <b>1 anta apertura verticale obliqua</b>  <b>N.B.: posizionare la cappa ad una distanza non inferiore ai 55 cm dal piano cottura</b></p> <p>"Mod. F" fully-integrated hood with glass pull-out front panel                      flow rate 390 m³/h with led lights                      1 door with vertical oblique opening  <b>Note: position the hood at least 55 cm from the cooker hob</b></p> 							
	<b>H 60 L 60</b>	EPC86460	662	688	—		
	<b>*H 72 L 60</b>	EPC86560	676	735	+262		
	<b>n° 2 filtri carbone attivo</b> 2 active carbon filters	08750894	31	31			
	<b>*mag.anta con intarsio</b> surcharge for door with inlaid		+15	+20			
	<b>*mag.anta con decoro metallico</b> surcharge for door with metallic decor		+50	+65			





# TIPOLOGIE CAPPE CAMINO

CHIMNEY HOOD TYPES

## cappa tipo "S" vedi pag. 52

chimney type "S"  
see page 52



## cappa tipo "SN" vedi pag. 53

chimney type "SN"  
see page 53



## cappa tipo "S2" vedi pag. 54

chimney type "S2"  
see page 54



## cappa tipo "E" vedi pag. 55

chimney type "E"  
see page 55



# TIPOLOGIE CAPPE CAMINO

CHIMNEY HOOD TYPES

## cappa tipo "I" vedi pag. 56

chimney type "I"  
see page 56



## cappa tipo "IN" vedi pag. 57

chimney type "IN"  
see page 57



## cappa fascione tipo "C" camino bucciato come anta vedi pag. 58

band chimney type "C"  
textured chimney hood to match door  
see page 58



## cappa isola vedi pag. 59

chimney island  
see page 59



# SCHEMA CAPPA CAMINETTO AD ANGOLO

CORNER CHIMNEY HOOD DIAGRAM

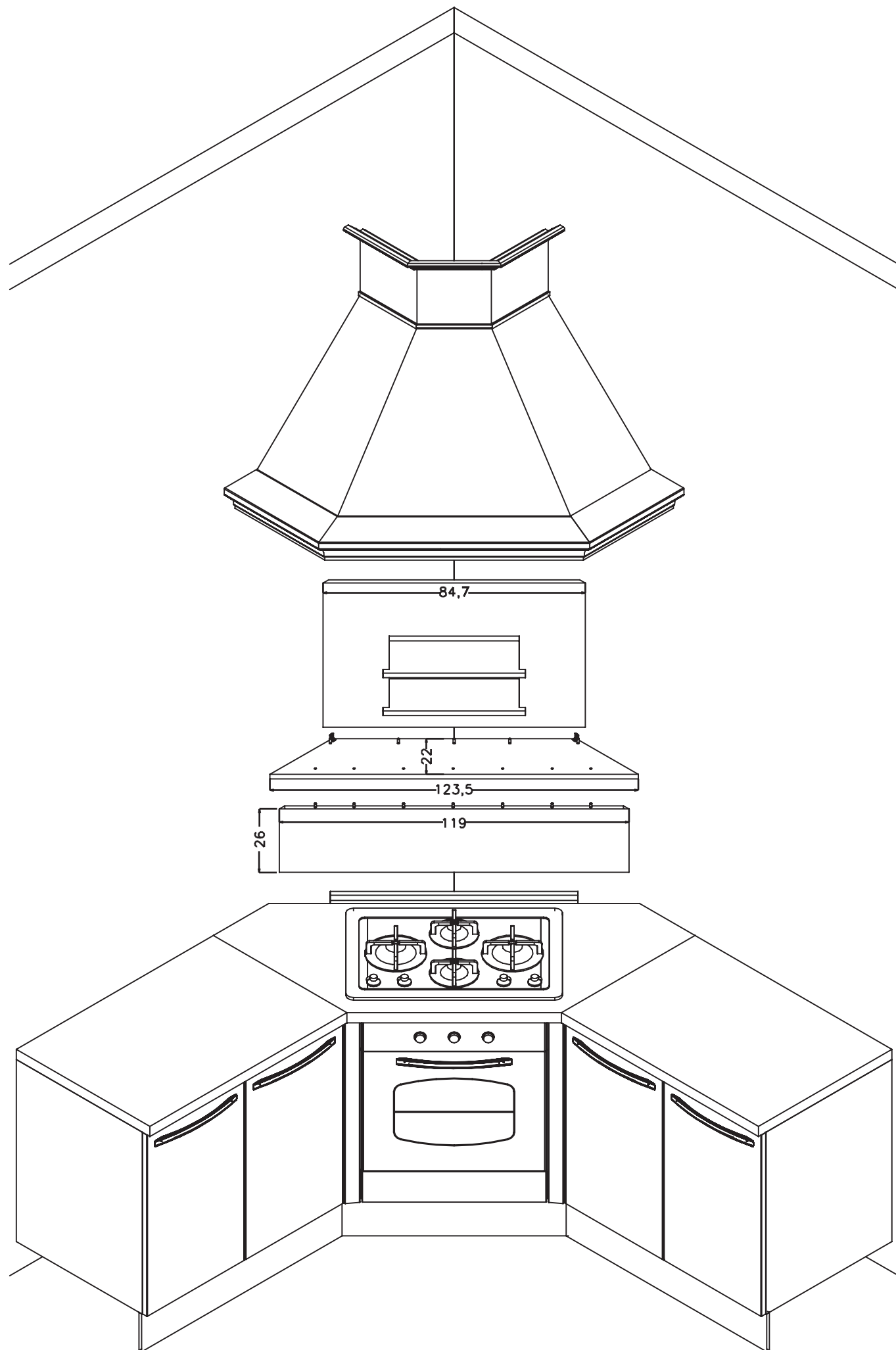

# SCHEMA CAPPA CAMINETTO AD ANGOLO

CORNER CHIMNEY HOOD DIAGRAM

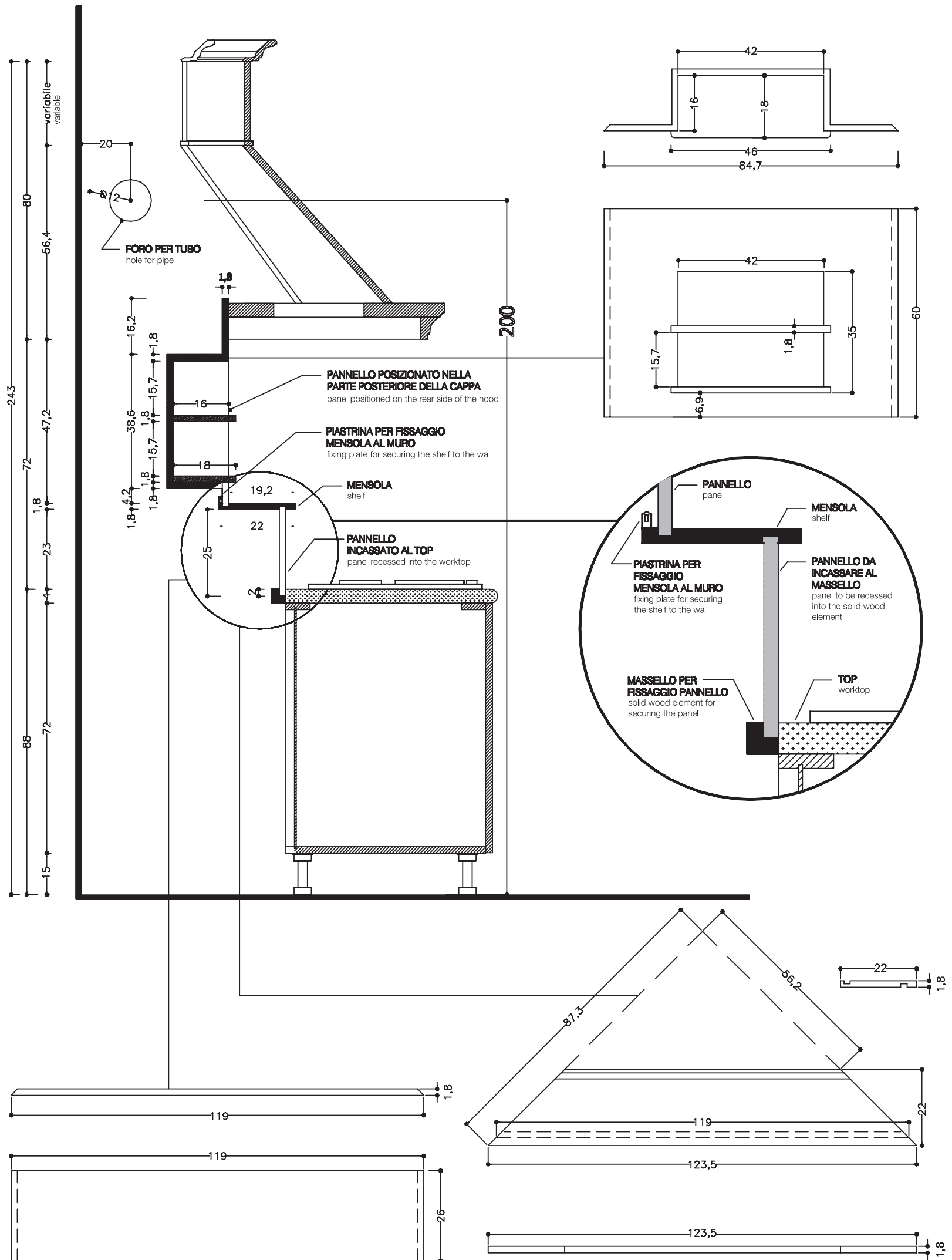

# CAPPE DI SERIE FASCIONE TIPO "S" CAMINO BUCCIATO

STANDARD HOOD BAND TYPE "S" TEXTURED CHIMNEY

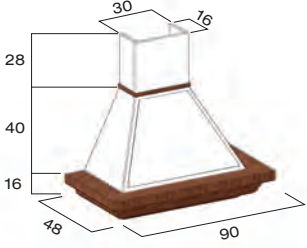
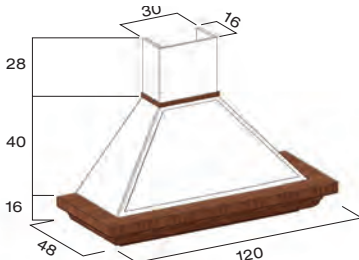
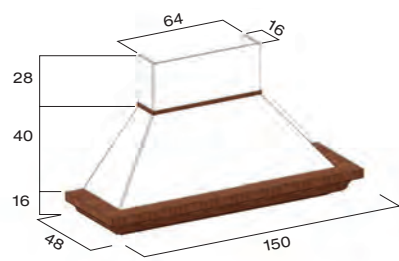
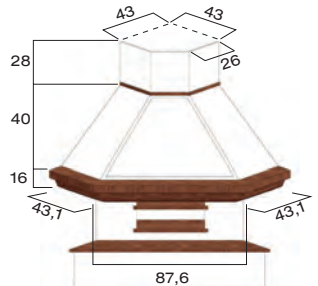
<p><b>DISPONIBILE ANCHE CON CAMINO NEI COLORI EFFETTO MURO PAG.59</b> ALSO AVAILABLE WITH CHIMNEY IN WALL EFFECT COLOURS PAGE 59</p>	COD.	FASCIA A K70	FASCIA B K70				
<p><b>Cappa caminetto 90 H 84 prof.48 con cornice, gruppo ASPIRANTE portata 320 m³/h, fascione sagomato in tinta come anta</b> 90 cm chimney hood H 84 depth 48 with cornice, EXTRACTOR UNIT air flow rate 320 m³/h, contoured band matching with the door</p>  <p style="text-align: right;"><b>camino bucciato bianco (opz.001)</b> white textured chimney (opz.001)</p>	E3758590	811	858				
<p><b>Cappa caminetto 120 H 84 prof.48 con cornice, gruppo ASPIRANTE portata 320 m³/h, fascione sagomato in tinta come anta</b> 120 cm chimney hood H 84 depth 48 with cornice, EXTRACTOR UNIT air flow rate 320 m³/h, contoured band matching with the door</p>  <p style="text-align: right;"><b>camino bucciato bianco (opz.001)</b> white textured chimney (opz.001)</p>	E3758620	895	948				
<p><b>Cappa caminetto 150 H 84 prof.48 con cornice, gruppo ASPIRANTE portata 320 m³/h, fascione sagomato in tinta come anta</b> 150 cm chimney hood H 84 depth 48 with cornice, EXTRACTOR UNIT air flow rate 320 m³/h, contoured band matching with the door</p>  <p style="text-align: right;"><b>camino bucciato bianco (opz.001)</b> white textured chimney (opz.001)</p>	E3758650	958	1.015				
<p><b>Cappa caminetto ad angolo 105x105, gruppo ASPIRANTE portata 320 m³/h, fascione sagomato in tinta come anta (completa di pannelli c/nicchia per cucina ad angolo 110x110 e cornice)</b> 105x105 corner chimney hood, EXTRACTOR UNIT air flow rate 320 m³/h, contoured band matching with the door, (including panels with niche for corner kitchen 110x110 and cornice)</p>  <p style="text-align: right;"><b>camino bucciato bianco (opz.001)</b> white textured chimney (opz.001)</p>	E3758610	1.029	1.089				

# CAPPE FASCIONE TIPO "SN" CAMINO BUCCIATO

HOOD BAND TYPE "SN" TEXTURED CHIMNEY

**DISPONIBILE ANCHE CON CAMINO NEI COLORI EFFETTO MURO PAG.59**  
 ALSO AVAILABLE WITH CHIMNEY IN WALL EFFECT COLOURS PAGE 59

**Cappa caminetto 90 H 84 prof.48 con cornice e camino con nicchia, gruppo ASPIRANTE portata 320 m³/h, fascione sagomato in tinta come anta**  
 90 cm chimney hood H 84 depth 48 with cornice and chimney with niche, EXTRACTOR UNIT air flow rate 320 m³/h, contoured band matching with the door

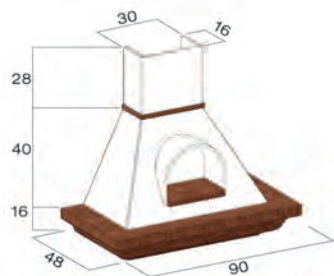

camino bucciato bianco (opz.001)  
 white textured chimney (opz.001)

COD.	FASCIA A K70	FASCIA B K70				
E3758090	905	958				

**Cappa caminetto 120 H 84 prof.48 con cornice e camino con nicchia, gruppo ASPIRANTE portata 320 m³/h, fascione sagomato in tinta come anta**  
 120 cm chimney hood H 84 depth 48 with cornice and chimney with niche, EXTRACTOR UNIT air flow rate 320 m³/h, contoured band matching with the door

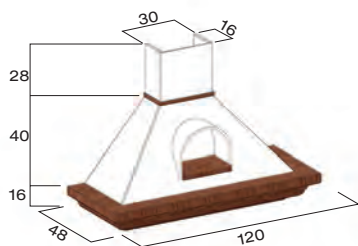

camino bucciato bianco (opz.001)  
 white textured chimney (opz.001)

E3758120	1.005	1.065				
----------	-------	-------	--	--	--	--

**Cappa caminetto 150 H 84 prof.48 con cornice e camino con nicchia, gruppo ASPIRANTE portata 320 m³/h, fascione sagomato in tinta come anta**  
 150 cm chimney hood H 84 depth 48 with cornice and chimney with niche, EXTRACTOR UNIT air flow rate 320 m³/h, contoured band matching with the door

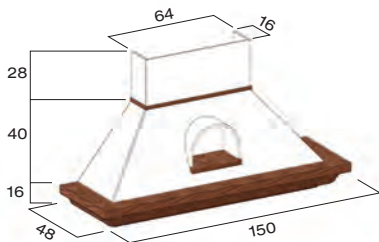

camino bucciato bianco (opz.001)  
 white textured chimney (opz.001)

E3758150	1.089	1.152				
----------	-------	-------	--	--	--	--

**Cappa caminetto ad angolo 105x105 e camino con nicchia, gruppo ASPIRANTE portata 320 m³/h, fascione sag.in tinta come anta (completa di pannelli c/nicchia per cucina ad angolo 110x110 e cornice)**  
 105x105 corner chimney hood and chimney with niche, EXTRACTOR UNIT air flow rate 320 m³/h, contoured band matching with the door (including panels with niche for corner kitchen 110x110 and cornice)

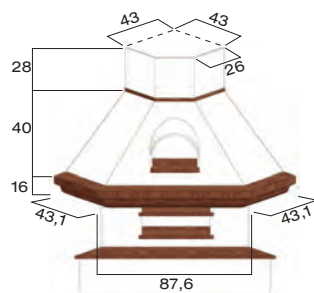

camino bucciato bianco (opz.001)  
 white textured chimney (opz.001)

E3758110	1.162	1.229				
----------	-------	-------	--	--	--	--

# CAPPE DI SERIE FASCIONE TIPO "S2" CAMINO BUCCIATO

STANDARD HOOD BAND TYPE "S2" TEXTURED CHIMNEY

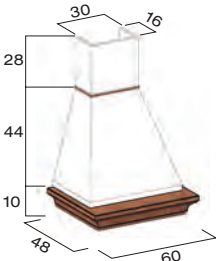
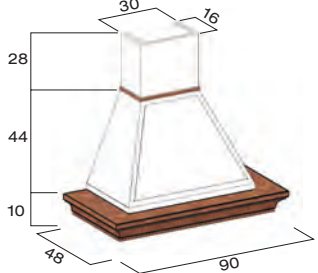
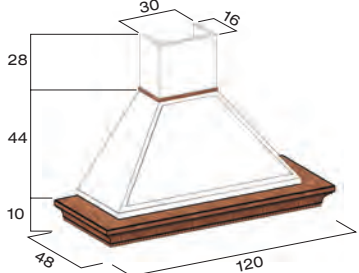
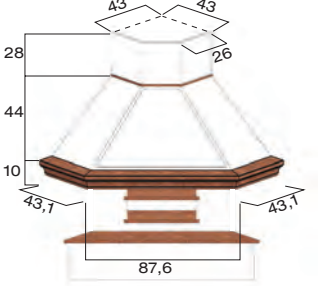
<p><b>DISPONIBILE ANCHE CON CAMINO NEI COLORI EFFETTO MURO PAG.59</b>                      ALSO AVAILABLE WITH CHIMNEY IN WALL EFFECT COLOURS PAGE 59</p>	COD.	FASCIA A K70	FASCIA B K70				
<p><b>Cappa caminetto 60 H 82 prof.48 con cornice, gruppo ASPIRANTE portata 320 m³/h, fascione sagomato "S2" in tinta come anta</b>                      60 cm chimney hood H 82 depth 48 with cornice, EXTRACTOR UNIT air flow rate 320 m³/h, contoured band "S2" matching with the door</p>  <p style="text-align: right;"><b>camino bucciato bianco (opz.001)</b> white textured chimney (opz.001)</p>	E3758705	678	718				
<p><b>Cappa caminetto 90 H 82 prof.48 con cornice, gruppo ASPIRANTE portata 320 m³/h, fascione sagomato "S2" in tinta come anta</b>                      90 cm chimney hood H 82 depth 48 with cornice, EXTRACTOR UNIT air flow rate 320 m³/h, contoured band "S2" matching with the door</p>  <p style="text-align: right;"><b>camino bucciato bianco (opz.001)</b> white textured chimney (opz.001)</p>	E3758710	771	815				
<p><b>Cappa caminetto 120 H 82 prof.48 con cornice, gruppo ASPIRANTE portata 320 m³/h, fascione sagomato "S2" in tinta come anta</b>                      120 cm chimney hood H 82 depth 48 with cornice, EXTRACTOR UNIT air flow rate 320 m³/h, contoured band "S2" matching with the door</p>  <p style="text-align: right;"><b>camino bucciato bianco (opz.001)</b> white textured chimney (opz.001)</p>	E3758720	882	932				
<p><b>Cappa caminetto ad angolo 105x105, gruppo ASPIRANTE portata 320 m³/h, fascione sagomato "S2" in tinta come anta (completa di pannelli c/nicchia per cucina ad angolo 110x110 e cornice)</b>                      105x105 corner chimney hood, EXTRACTOR UNIT air flow rate 320 m³/h, contoured band "S2" matching with the door, (including panels with niche for corner kitchen 110x110 and cornice)</p>  <p style="text-align: right;"><b>camino bucciato bianco (opz.001)</b> white textured chimney (opz.001)</p>	E3758730	1.313	1.389				

# CAPPE FASCIONE TIPO "E" CAMINO BUCCIATO

HOOD BAND TYPE "E" TEXTURED CHIMNEY

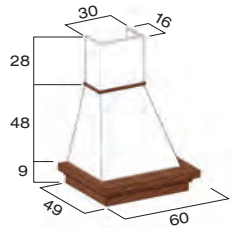
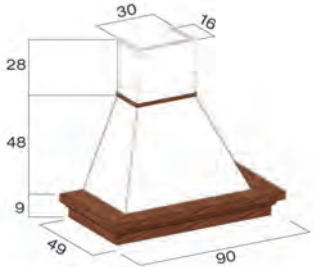
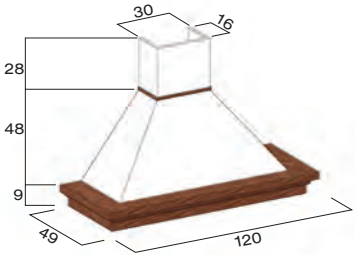
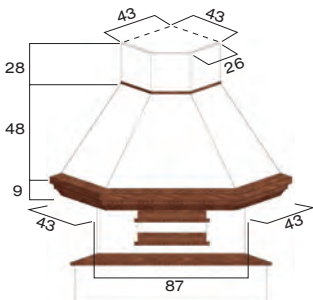
	COD.	FASCIA A K70	FASCIA B K70			
<p><b>Cappa caminetto 60 H 85 prof.49 con cornice, gruppo ASPIRANTE portata 320 m³/h, fascione in tinta come anta</b> 60 cm chimney hood H 85 depth 49 with cornice, EXTRACTOR UNIT air flow rate 320 m³/h, band matching with the door</p> 						
<p><b>camino bucciato bianco (opz.001)</b> white textured chimney (opz.001)</p>	E3970600	537	567			
<p><b>Cappa caminetto 90 H 85 prof.49 con cornice, gruppo ASPIRANTE portata 320 m³/h, fascione in tinta come anta</b> 90 cm chimney hood H 85 depth 49 with cornice, EXTRACTOR UNIT air flow rate 320 m³/h, band matching with the door</p> 						
<p><b>camino bucciato bianco (opz.001)</b> white textured chimney (opz.001)</p>	E3970900	581	614			
<p><b>Cappa caminetto 120 H 85 prof.49 con cornice, gruppo ASPIRANTE portata 320 m³/h, fascione in tinta come anta</b> 120 cm chimney hood H 85 depth 49 with cornice, EXTRACTOR UNIT air flow rate 320 m³/h, band matching with the door</p> 						
<p><b>camino bucciato bianco (opz.001)</b> white textured chimney (opz.001)</p>	E3971200	598	631			
<p><b>Cappa caminetto ad angolo 105x105, gruppo ASPIRANTE portata 320 m³/h, fascione in tinta come anta (completa di pannelli c/nicchia per cucina ad angolo 110x110 e cornice)</b> 105x105 corner chimney hood, EXTRACTOR UNIT air flow rate 320 m³/h, band matching with the door (including panels with niche for corner kitchen 110x110 and cornice)</p> 						
<p><b>camino bucciato bianco (opz.001)</b> white textured chimney (opz.001)</p>	E3972110	788	835			



# CAPPE FASCIONE TIPO "I" CAMINO BUCCIATO

HOOD BAND TYPE "I" TEXTURED CHIMNEY

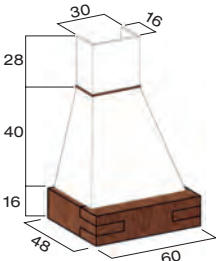
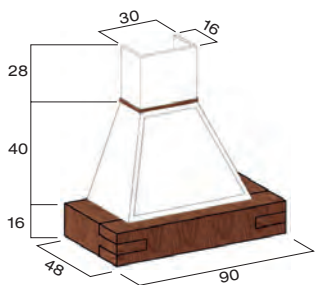
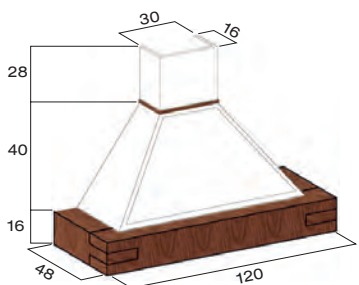
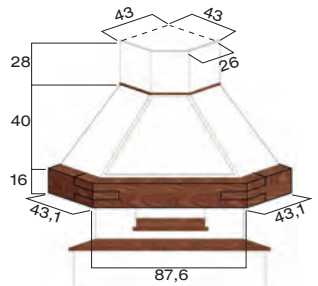
<p><b>DISPONIBILE ANCHE CON CAMINO NEI COLORI EFFETTO MURO PAG.59</b> ALSO AVAILABLE WITH CHIMNEY IN WALL EFFECT COLOURS PAGE 59</p>	COD.	FASCIA A K70	FASCIA B K70				
<p><b>Cappa caminetto 60 H 84 prof.48 con cornice, gruppo ASPIRANTE</b> <b>portata 320 m³/h, fascione in tinta come anta</b> 60 cm chimney hood H 84 depth 48 with cornice, EXTRACTOR UNIT air flow rate 320 m³/h, band matching with the door</p>  <p style="text-align: right;"><b>camino bucciato bianco (opz.001)</b> white textured chimney (opz.001)</p>	E3756260	701	741				
<p><b>Cappa caminetto 90 H 84 prof.48 con cornice, gruppo ASPIRANTE</b> <b>portata 320 m³/h, fascione in tinta come anta</b> 90 cm chimney hood H 84 depth 48 with cornice, EXTRACTOR UNIT air flow rate 320 m³/h, band matching with the door</p>  <p style="text-align: right;"><b>camino bucciato bianco (opz.001)</b> white textured chimney (opz.001)</p>	E3756290	768	811				
<p><b>Cappa caminetto 120 H 84 prof.48 con cornice, gruppo ASPIRANTE</b> <b>portata 320 m³/h, fascione in tinta come anta</b> 120 cm chimney hood H 84 depth 48 with cornice, EXTRACTOR UNIT air flow rate 320 m³/h, band matching with the door</p>  <p style="text-align: right;"><b>camino bucciato bianco (opz.001)</b> white textured chimney (opz.001)</p>	E3756320	871	922				
<p><b>Cappa caminetto ad angolo 105x105 con gruppo ASPIRANTE, portata</b> <b>320 m³/h, fascione in tinta come anta (completa di pannelli c/nicchia per</b> <b>cucina ad angolo 110x110 e cornice)</b> 105x105 corner chimney hood, EXTRACTOR UNIT air flow rate 320 m³/h, band matching with the door (including panels with niche for corner kitchen 110x110 and cornice)</p>  <p style="text-align: right;"><b>camino bucciato bianco (opz.001)</b> white textured chimney (opz.001)</p>	E3756310	1.005	1.065				

# CAPPE FASCIONE TIPO "IN" CAMINO BUCCIATO

HOOD BAND TYPE "IN" TEXTURED CHIMNEY

**DISPONIBILE ANCHE CON CAMINO NEI COLORI EFFETTO MURO PAG.59**  
ALSO AVAILABLE WITH CHIMNEY IN WALL EFFECT COLOURS PAGE 59

**Cappa caminetto 90 H 84 prof.48 con cornice e camino con nicchia, gruppo ASPIRANTE portata 320 m³/h, fascione in tinta come anta**  
90 cm chimney hood H 84 depth 48 with cornice and chimney with niche, EXTRACTOR UNIT air flow rate 320 m³/h, band matching with the door

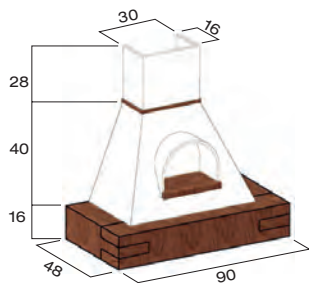

camino bucciato bianco (opz.001)  
white textured chimney (opz.001)

COD.

FASCIA  
A  
K70

FASCIA  
B  
K70

E3756590

922

975

**Cappa caminetto 120 H 84 prof.48 con cornice e camino con nicchia, gruppo ASPIRANTE portata 320 m³/h, fascione in tinta come anta**  
120 cm chimney hood H 84 depth 48 with cornice and chimney with niche, EXTRACTOR UNIT air flow rate 320 m³/h, band matching with the door

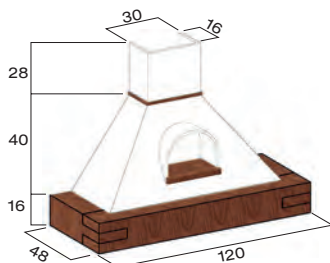

camino bucciato bianco (opz.001)  
white textured chimney (opz.001)

E3756620

1.039

1.099

**Cappa caminetto ad angolo 105x105 e camino con nicchia, gruppo ASPIRANTE portata 320 m³/h, fascione in tinta come anta (completa di pannelli c/nicchia per cucina ad angolo 110x110 e cornice)**  
105x105 corner chimney hood and niche, EXTRACTOR UNIT air flow rate 320 m³/h, band matching with the door (including panels with niche for corner kitchen 110x110 and cornice)

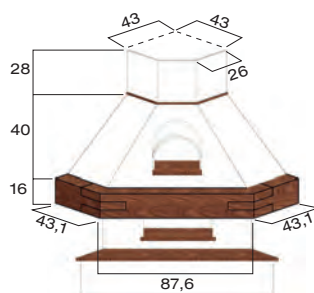

camino bucciato bianco (opz.001)  
white textured chimney (opz.001)

E3756610

1.206

1.276

# CAPPE TIPO "C" CAMINO BUCCIATO

HOODS TYPE "C" TEXTURED CHIMNEY

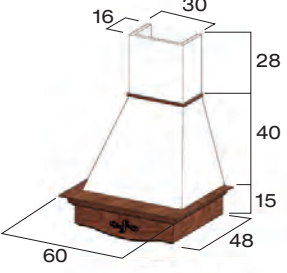
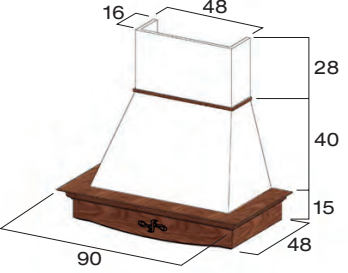
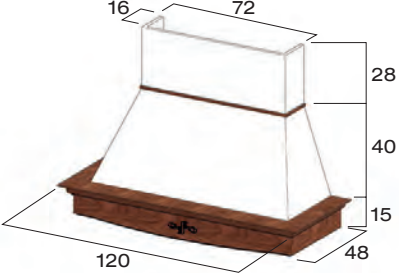
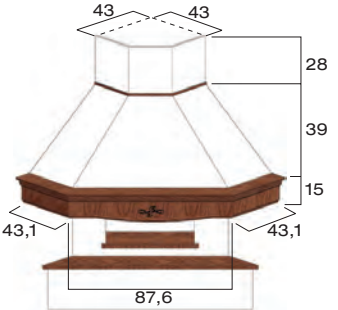
<p><b>DISPONIBILE ANCHE CON CAMINO NEI COLORI EFFETTO MURO PAG.59</b>                      ALSO AVAILABLE WITH CHIMNEY IN WALL EFFECT COLOURS PAGE 59</p>	COD.	FASCIA A K70	FASCIA B K70				
<p><b>Cappa caminetto 60 H 84 prof.48 con cornice, fascione con archetto colore come anta gruppo ASPIRANTE portata 320 m³/h</b>                      60 cm chimney hood H 84 depth 48 with cornice, arch band matching with the door                      EXTRACTOR UNIT air flow rate 320 m³/h</p>  <p style="text-align: right;"><b>fascione tipo "C" camino bucciato bianco (opz.001)</b>                      band type "C" white textured chimney (opz.001)</p>	E3754060	714	755				
<p><b>Cappa caminetto 90 H 84 prof.48 con cornice, fascione con archetto colore come anta gruppo ASPIRANTE portata 320 m³/h</b>                      90 cm chimney hood H 84 depth 48 with cornice, arch band matching with the door                      EXTRACTOR UNIT air flow rate 320 m³/h</p>  <p style="text-align: right;"><b>fascione tipo "C" camino bucciato bianco (opz.001)</b>                      band type "C" white textured chimney (opz.001)</p>	E3754090	755	798				
<p><b>Cappa caminetto 120 H 84 prof.48 con cornice, fascione con archetto colore come anta gruppo ASPIRANTE portata 320 m³/h</b>                      120 cm chimney hood H 84 depth 48 with cornice, arch band matching with the door                      EXTRACTOR UNIT air flow rate 320 m³/h</p>  <p style="text-align: right;"><b>fascione tipo "C" camino bucciato bianco (opz.001)</b>                      band type "C" white textured chimney (opz.001)</p>	E3754120	805	851				
<p><b>Cappa caminetto ad angolo 105x105, fascione con archetto colore come anta, gruppo ASPIRANTE portata 320 m³/h (completa di pannelli c/nicchia per cucina ad angolo 110x110 e cornice)</b>                      105x105 corner chimney hood, arch band matching with the door                      EXTRACTOR UNIT air flow rate 320 m³/h                      (including panels with niche for corner kitchen 110x110 and cornice)</p>  <p style="text-align: right;"><b>fascione tipo "C" camino bucciato bianco (opz.001)</b>                      band type "C" white textured chimney (opz.001)</p>	E3754110	1.059	1.119				

# CAPPE ISOLA CAMINO BUCCIATO

ISLAND HOOD TEXTURED CHIMNEY

DISPONIBILE ANCHE CON CAMINO NEI COLORI EFFETTO MURO PAG.59  
ALSO AVAILABLE WITH CHIMNEY IN WALL EFFECT COLOURS PAGE 59

Cappa isola con fascione in tinta come anta  
gruppo ASPIRANTE portata 320 m³/h

Island hood with band matching with the door  
EXTRACTOR UNIT air flow rate 320 m³/h

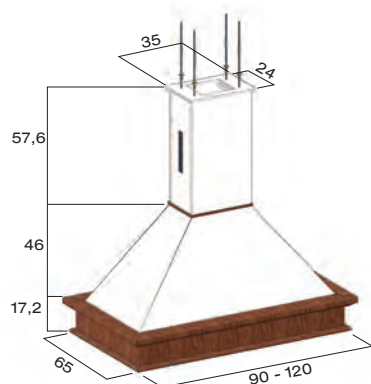

L 90

E3752129

1.229

1.302

L 120

E3752130

1.276

1.349

camino bucciato bianco  
(opt.001)

white textured chimney (opt.001)

## COLORI EFFETTO MURO PER CAMINI CAPPE WALL EFFECT COLOURS FOR CHIMNEY HOODS

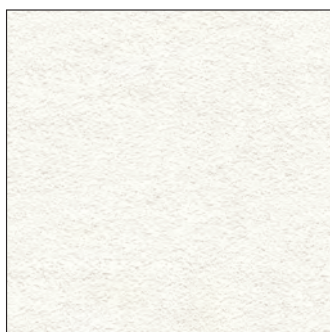

**BIANCO ASSOLUTO**  
a rullo (opt.R005)  
frattonato (opt.F005)

ABSOLUTE WHITE  
for roller (opt.R005)  
for trowel (opt.F005)



**CIPRIA**  
a rullo (opt.R114)  
frattonato (opt.F114)

PALE PINK  
for roller (opt.R114)  
for trowel (opt.F114)



**PANNA**  
a rullo (opt.R012)  
frattonato (opt.F012)

CREAM  
for roller (opt.R012)  
for trowel (opt.F012)

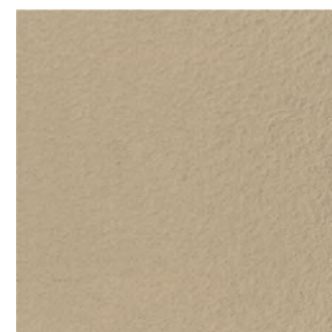

**CORDA**  
a rullo (opt.R125)  
frattonato (opt.F125)

JUTE  
for roller (opt.R125)  
for trowel (opt.F125)



**GRIGIO TRAFFICO**  
a rullo (opt.R260)  
frattonato (opt.F260)

TRAFFIC GREY  
for roller (opt.R260)  
for trowel (opt.F260)



**GRIGIO PERLA**  
a rullo (opt.R255)  
frattonato (opt.F255)

PEARL GREY  
for roller (opt.R255)  
for trowel (opt.F255)







**GIALLO CHIARO**  
a rullo (opt.R023)  
frattonato (opt.F023)

LIGHT YELLOW  
for roller (opt.R023)  
for trowel (opt.F023)





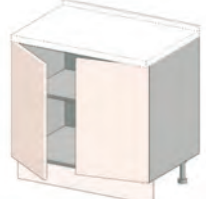







**CUOIO**  
a rullo (opt.R250)  
frattonato (opt.F250)

LEATHER  
for roller (opt.R250)  
for trowel (opt.F250)



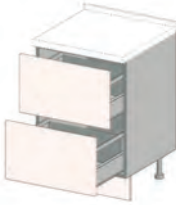
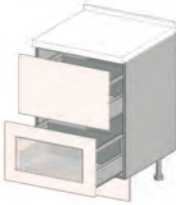

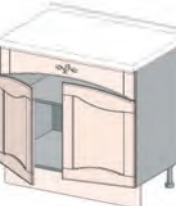
LE BASI NON SONO COMPRENSIVE DI TOP THE BASE UNITS DO NOT INCLUDE THE TOPS		COD.	FASCIA A K70	FASCIA B K70				
 <p><b>fascia tamponamento</b> filler panel</p>								
	<b>L da 3 a 10</b> size from 3 to 10	E4800000	69	84				
 <p><b>jolly base</b> <b>L da 10 a 30</b> jolly base unit size from 10 to 30</p>								
	<b>in nobilitato</b> melamine coated	E4700000	80	80				
	<b>impiallacciato</b> veneered	E4710000	345	365				
 <p><b>1 anta</b> 1 door</p>	<b>L 15</b>	E4010151/2	124	137				
	<b>L 30</b>	E4010301/2	151	170				
	<b>L 40</b>	E4010401/2	164	185				
	<b>*L 45</b>	E4010451/2	169	191				
	<b>*L 60</b>	E4010601/2	197	226				
	<b>L 65</b>	E4010651/2	217	249				
	<b>*mag.anta con intarsio</b> surcharge for door with inlaid		+15	+20				
	<b>*mag.anta con decoro metallico</b> surcharge for door with metallic decor		+50	+65				
 <p><b>2 ante</b> 2 doors</p>								
	<b>L 60</b>	E4010600	251	288				
	<b>L 80</b>	E4010800	276	319				
	<b>*L 90</b>	E4010900	289	334				
	<b>*mag.ante con intarsio</b> surcharge for doors with inlaid		+30	+40				
	<b>*mag.ante con decoro metallico</b> surcharge for doors with metallic decor		+100	+130				
 <p><b>cestello estraibile</b> <b>chiusura soft</b> pull-out basket unit soft-closing system</p>								
	<b>L 15</b>	E4150150	145	158				
	<b>L 30</b>	E4150300	214	233				
	<b>L 45</b>	E4150450	234	256				
 <p><b>1 anta H 60</b> <b>1 cassetto H 12</b> 1 door H 60 1 drawer H 12</p>								
	<b>L 45</b>	E4021451/2	251	285				
	<b>L 60</b>	E4021601/2	283	324				

**LE BASI NON SONO COMPRENSIVE DI TOP**  
THE BASE UNITS DO NOT INCLUDE THE TOPS

		COD.	FASCIA A K70	FASCIA B K70				
 <p><b>2 ante H 60</b> <b>1 cassetto H 12</b> 2 doors H 60 1 drawer H 12</p>								
	L 90	E4021900	385	439				
 <p><b>4 cassetti H 18</b> 4 drawers H 18</p>								
	L 30	E4101300	382	438				
	L 40	E4101400	396	456				
	L 45	E4101450	410	468				
	L 60	E4101600	453	505				
 <p><b>2 cassetti H 18</b> <b>1 cestone H 36</b> 2 drawers H 18 1 deep drawer H 36</p>								
	L 45	E4131450	366	412				
	L 60	E4131600	401	446				
	L 90	E4131900	479	534				
				+15	+20			
			+50	+65				
			<p><b>mag.cestone con intarsio</b> surcharge for deep drawer with inlaid</p> <p><b>mag.cestone con decoro metallico</b> surcharge for deep drawer with metallic decor</p>					
 <p><b>2 cassetti H 18</b> <b>1 cestone vetro H 36</b> 2 drawers H 18 1 glass deep drawer H 36</p>								
	L 45	E4141450	411	468				
	L 60	E4141600	451	508				
	L 90	E4141900	545	616				
 <p><b>4 cassetti H 18</b> <b>1 cestone H 36</b> 4 drawers H 18 1 deep drawer H 36</p>								
	L 60	E4300600	574	649				
	L 90	E4300900	635	717				
				+15	+20			
				+50	+65			
			<p><b>mag.cestone con intarsio</b> surcharge for deep drawer with inlaid</p> <p><b>mag.cestone con decoro metallico</b> surcharge for deep drawer with metallic decor</p>					
 <p><b>4 cassetti H 18</b> <b>1 cestone vetro H 36</b> 4 drawers H 18 1 glass deep drawer H 36</p>								
	L 60	E4301600	679	707				
	L 90	E4301900	709	807				

LE BASI NON SONO COMPRENSIVE DI TOP THE BASE UNITS DO NOT INCLUDE THE TOPS		COD.	FASCIA A K70	FASCIA B K70					
 <p><b>2 cestoni H 36</b> 2 deep drawers H 36</p>	L 45	E4171450	322	356					
	L 60	E4171600	349	386					
	L 90	E4171900	413	462					
				+15	+20				
				+50	+65				
<p><b>mag.cestone con intarsio cad.</b> surch.deep drawer with inlaid each</p> <p><b>mag.cestone con decoro metallico cad.</b> surch.deep drawer with metallic decor each</p>									
 <p><b>2 cestoni</b> <b>1 frontale chiuso H 36</b> <b>1 frontale vetro H 36</b> 2 deep drawers 1 full front H 36 1 glass front H 36</p>	L 45	E4181450	367	413					
	L 60	E4181600	400	449					
	L 90	E4181900	479	544					
				+15	+20				
				+50	+65				
<p><b>mag.cestone con intarsio</b> surcharge deep drawer with inlaid</p> <p><b>mag.cestone con decoro metallico</b> surcharge deep drawer with metallic decor</p>									
 <p><b>2 cestoni vetro H 36</b> 2 glass deep drawers H 36</p>	L 45	E4191450	412	468					
	L 60	E4191600	449	510					
	L 90	E4191900	543	624					
 <p><b>base</b> <b>2 ante e fascia sagomate</b> base unit 2 doors and band shaped</p>	L 90	E4050900	417	502					
	L 120	E4051200	484	586					
 <p><b>terminale 1 anta tipo "C"</b> <b>N.B.: non disponibile per le finiture grigio reale (opz.2454) e bianco artico (opz.2491)</b> end base unit 1 door type "C" Note: not available for royal grey (opt.2454) and arctic white (opt.2491)</p>	L 34,5	E4670311/2	345	413					
 <p><b>terminale a giorno tipo "C"</b> open end base unit type "C"</p>	<p><b>in nobilitato L 34,5</b> melamine coated</p> <p><b>impiallacciato L 34,5</b> veneered</p>		E4620311/2	112	112				
			E4621311/2	441	466				

**LE BASI NON SONO COMPRENSIVE DI TOP**  
THE BASE UNITS DO NOT INCLUDE THE TOPS

	COD.	FASCIA A K70	FASCIA B K70				
 <p><b>base vano a giorno con cornice sagomata 1 cestone H 36</b> base unit with open compartment and contoured frame 1 deep drawer H 36</p>	L 60	E4341600	282	319			
			+15	+20			
			+50	+65			
 <p><b>base vano a giorno con cornice sagomata 1 cestone H 36</b> base unit with open compartment and contoured frame 1 deep drawer H 36</p>	L 90	E4341900	333	374			
			+15	+20			
			+50	+65			
 <p><b>base vano a giorno con cornice sagomata 1 cestone vetro H 36</b> base unit with open compartment and contoured frame 1 glass deep drawer H 36</p>	L 60	E4342600	331	381			
 <p><b>base vano a giorno con cornice sagomata 1 cestone vetro H 36</b> base unit with open compartment and contoured frame 1 glass deep drawer H 36</p>	L 90	E4342900	398	456			

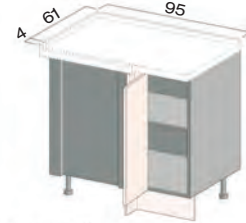
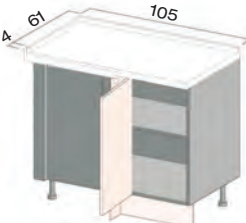
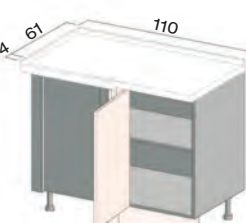
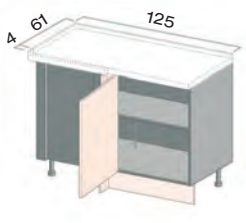
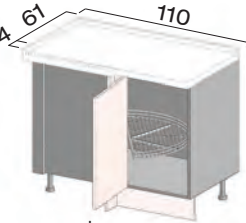
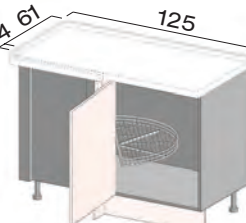

LE BASI NON SONO COMPRENSIVE DI TOP THE BASE UNITS DO NOT INCLUDE THE TOPS		COD.	FASCIA A K70	FASCIA B K70					
 <p><b>angolo L 95</b> <b>1 ripiano</b> <b>1 anta L 30</b> <b>cassone 90</b> corner unit W 95 1 shelf 1 door W 30 structure 90</p> <p>verso dx RH version</p>	<p><b>95x65</b></p>	E4400951/2	299	338					
		 <p><b>angolo L 105</b> <b>1 ripiano</b> <b>1 anta L 40</b> <b>cassone 90</b> corner unit W 105 1 shelf 1 door W 40 structure 90</p> <p>verso dx RH version</p>	<p><b>105x65</b></p>	E4401041/2	305	347			
 <p><b>angolo L 110</b> <b>1 ripiano</b> <b>1 anta L 45</b> <b>cassone 105</b> corner unit W 110 1 shelf 1 door W 45 structure 105</p> <p>verso dx RH version</p>	<p><b>110x65</b></p>			E4401091/2	314	356			
		<p><b>mag.anta con intarsio</b> surcharge for door with inlaid</p>		+15	+20				
		<p><b>mag.anta con decoro metallico</b> surcharge for door with metallic decor</p>		+50	+65				
 <p><b>angolo L 125</b> <b>1 ripiano</b> <b>1 anta L 60</b> <b>cassone 120 con tirante</b> corner unit W 125 1 shelf 1 door W 60 structure 120 with tie beam</p> <p>verso dx RH version</p>	<p><b>125x65</b></p>	E4401241/2	349	398					
		<p><b>mag.anta con intarsio</b> surcharge for door with inlaid</p>		+15	+20				
		<p><b>mag.anta con decoro metallico</b> surcharge for door with metallic decor</p>		+50	+65				
 <p><b>angolo L 110</b> <b>cestello mezzaluna orion grau</b> <b>1 anta L 45</b> <b>cassone 105</b> corner unit W 110 crescent-shaped orion grau wire basket unit 1 door W 45 structure 105</p> <p>verso dx RH version</p>	<p><b>1 cestello 110x65</b> 1 basket drawer</p> <p><b>2 cestelli 110x65</b> 2 basket drawers</p>	E4401101/2	325	367					
		<p><b>mag.anta con intarsio</b> surcharge for door with inlaid</p>		+15	+20				
		<p><b>mag.anta con decoro metallico</b> surcharge for door with metallic decor</p>		+50	+65				
		 <p><b>angolo L 125</b> <b>cestello mezzaluna orion grau</b> <b>1 anta L 60</b> <b>cassone 120</b> corner unit W 125 crescent-shaped orion grau wire basket unit 1 door W 60 structure 120</p> <p>verso dx RH version</p>	<p><b>1 cestello 125x65</b> 1 basket drawer</p> <p><b>2 cestelli 125x65</b> 2 basket drawers</p>	E4401251/2	402	353			
<p><b>mag.anta con intarsio</b> surcharge for door with inlaid</p>				+15	+20				
<p><b>mag.anta con decoro metallico</b> surcharge for door with metallic decor</p>				+50	+65				

# BASI ANGOLO

CORNER BASE UNITS

H 87 P 65

**LE BASI NON SONO COMPRENSIVE DI TOP**  
THE BASE UNITS DO NOT INCLUDE THE TOPS

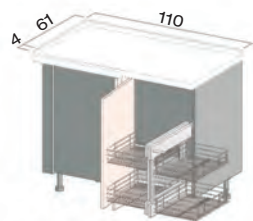

verso dx  
RH version

**angolo L 110**  
**4 cestelli orion grau estraibili indipendenti**  
**1 anta L 45**  
**cassone 105**  
corner unit W 110  
4 pull-out orion grau basket unit opening independently from door  
1 door W 45  
structure 105

**110x65**

**mag.anta con intarsio**  
surcharge for door with inlaid  
**mag.anta con decoro metallico**  
surcharge for door with metallic decor

COD.

**FASCIA A**  
K70

**FASCIA B**  
K70

E4451101/2

835

877

+15

+20

+50

+65

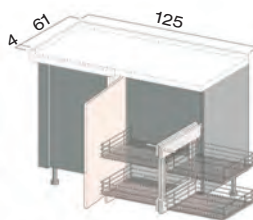

verso dx  
RH version

**angolo L 125**  
**4 cestelli orion grau estraibili indipendenti**  
**1 anta L 60**  
**cassone 120**  
corner unit W 125  
4 pull-out orion grau basket unit opening independently from door  
1 door W 60  
structure 120

**125x65**

**mag.anta con intarsio**  
surcharge for door with inlaid  
**mag.anta con decoro metallico**  
surcharge for door with metallic decor

E4451251/2

913

962

+15

+20

+50

+65

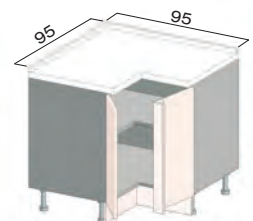

**angolo 95x95**  
**1 ripiano - 2 ante L 30**  
**angolare unito all'anta dx**  
corner unit 95x95  
1 shelf - 2 doors W 30  
angular filler attached to the RH door

**95x95**

E4481950

660

724

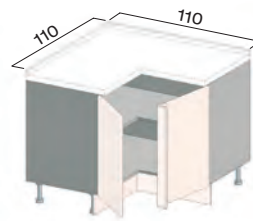

**angolo 110x110**  
**1 ripiano - 2 ante L 45**  
**angolare unito all'anta dx**  
corner unit 110x110  
1 shelf - 2 doors W 45  
angular filler attached to the RH door

**110x110**

**mag.ante con intarsio**  
surcharge doors with inlaid  
**mag.ante con decoro metallico**  
surcharge doors with metallic decor

E4482100

710

782

+30

+40

+100

+130

# BASI ANGOLO PANNELLO IMPIALLACCIATO COME ANTA

H 87 P 59,9

CORNER BASE UNITS VENEERED PANEL AS DOOR

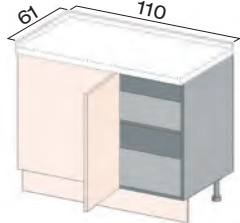
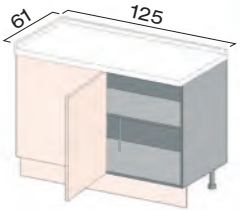
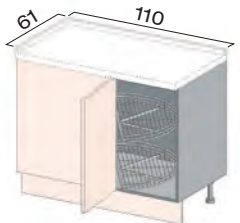
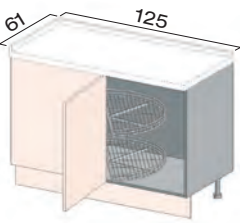
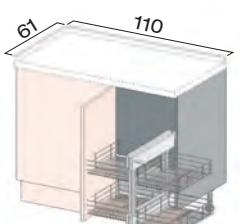
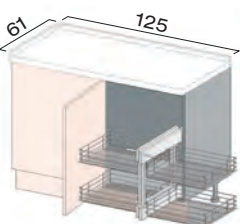
LE BASI NON SONO COMPRENSIVE DI TOP THE BASE UNITS DO NOT INCLUDE THE TOPS		COD.	FASCIA A K70	FASCIA B K70				
 <p><b>angolo L 110</b> 1 ripiano 1 anta L 45 pannello impiallacciato come anta cassone 110 corner unit W 110 1 shelf 1 door W 45 veneered panel same as door structure 110</p> <p>verso dx RH version</p>	110x61	E4403091/2	362	416				
 <p><b>angolo L 125</b> 1 ripiano 1 anta L 60 pannello impiallacciato come anta cassone 125 con tirante corner unit W 125 1 shelf 1 door W 60 veneered panel same as door structure 125 with tie beam</p> <p>verso dx RH version</p>	125x61	E4403241/2	382	443				
 <p><b>angolo L 110</b> 2 cestelli mezzaluna orion grau 1 anta L 45 pannello impiallacciato come anta cassone 110 corner unit W 110 2 crescent-shaped orion grau wire basket units 1 door W 45 veneered panel same as door structure 110</p> <p>verso dx RH version</p>	110x61	E4403111/2	384	438				
 <p><b>angolo L 125</b> 2 cestelli mezzaluna orion grau 1 anta L 60 pannello impiallacciato come anta cassone 125 corner unit W 125 2 crescent-shaped orion grau wire basket units 1 door W 60 veneered panel same as door structure 125</p> <p>verso dx RH version</p>	125x61	E4403261/2	414	475				
 <p><b>angolo L 110</b> 4 cestelli orion grau estraibili indipendenti dall'anta 1 anta L 45 pannello impiallacciato come anta cassone 110 corner unit W 110 4 pull-out orion grau basket units opening independently from door 1 door W 45 veneered panel same as door structure 110</p> <p>verso dx RH version</p>	110x61	E4453101/2	894	948				
 <p><b>angolo L 125</b> 4 cestelli orion grau estraibili indipendenti dall'anta 1 anta L 60 pannello impiallacciato come anta cassone 125 corner unit W 125 4 pull-out orion grau basket units opening independently from door 1 door W 60 veneered panel same as door structure 125</p> <p>verso dx RH version</p>	125x61	E4453251/2	974	1.035				

# BASI PER FORNI



H 87 P 59,9

OVEN BASE UNITS

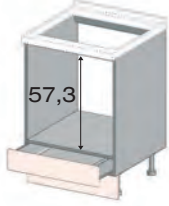
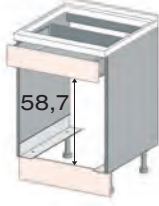
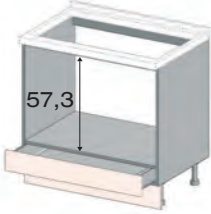
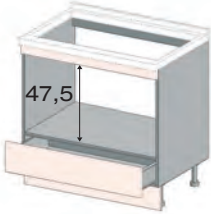

**LE BASI NON SONO COMPRENSIVE DI TOP**  
THE BASE UNITS DO NOT INCLUDE THE TOPS

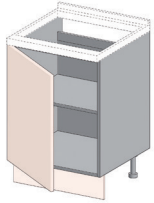
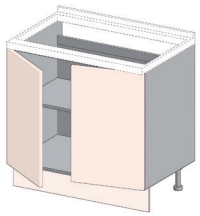
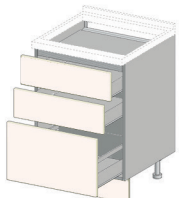
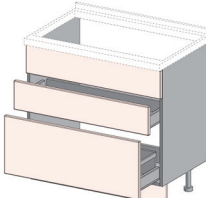
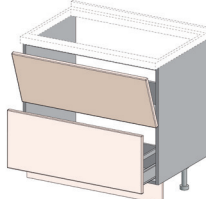
	COD.	FASCIA A K70	FASCIA B K70				
 <p><b>base per forno elettrico H 60</b> <b>cassetto H 12 inferiore</b> electric oven base unit H 60 lower drawer H 12</p>	L 60	E5510607	205	220			
	 <p><b>base per forno elettrico H 60</b> <b>cassetto H 12 superiore</b> electric oven base unit H 60 upper drawer H 12</p>	L 60	E5510608	205	220		
 <p><b>base per forno elettrico H 60</b> <b>frontale superiore fisso H 12</b> <b>N.B.: da utilizzare per top H 2 e per P.C. filo top</b> electric oven base unit H 60 fixed upper front H 12 Note: to be used in conjunction with tops H 2 and flush hobs</p>		L 60	E5510620	138	154		
	 <p><b>base per maxiforno H 60</b> <b>cassetto H 12</b> maxi-oven base unit H 60 drawer H 12</p>	L 90	E5510907	246	260		
 <p><b>base per maxiforno H 48</b> <b>cassetto H 18</b> <b>fascia superiore H 5,9</b> maxi-oven base unit H 48 drawer H 18 strip above H 5,9</p>		L 90	E5510920	283	314		
	 <p><b>kit raccordo base angolo</b> junction kit for corner base unit</p>	110x110	E5471100	122	151		
 <p><b>kit raccordo base angolo per inserimento lavastoviglie a destra o sinistra</b> junction kit for corner base unit for dishwasher placed on the right or the left side</p>		110x110	E5471151/2	160	189		

verso dx  
RH version

LE BASI NON SONO COMPRENSIVE DI TOP THE BASE UNITS DO NOT INCLUDE THE TOPS		COD.	FASCIA A K70	FASCIA B K70				
 <p><b>base predisposta piano cottura 1 ante</b> base unit configured for cooker hob 1 door</p>	L 60	E5500601/2	203	231				
			+15	+20				
			+50	+65				
		opz.101		+55	+55			
<p><b>mag.anta con intarsio</b> surcharge for door with inlaid</p> <p><b>mag.anta con decoro metallico</b> surcharge for door with metallic decor</p> <p><b>mag.base piano cottura ad induzione</b> surcharge base unit for induction cooker hob</p>								
 <p><b>base predisposta piano cottura 2 ante</b> base unit configured for cooker hob 2 doors</p>	L 90	E5500900	296	340				
			+30	+40				
			+100	+130				
		opz.101		+55	+55			
<p><b>mag.ante con intarsio</b> surcharge for doors with inlaid</p> <p><b>mag.ante con decoro metallico</b> surcharge for doors with metallic decor</p> <p><b>mag.base piano cottura ad induzione</b> surcharge base unit for induction cooker hob</p>								
 <p><b>Maggiorazione</b> <b>per base predisposta piano cottura ad induzione</b> <b>con lamierino di protezione</b> <b>N.B.: realizzabile su base 2 cassetti+1 cestone, base 2 cestoni e base 4 cassetti</b> <b>Surcharge</b> for base unit configured for induction cooker hob with protection metal sheet Note: available on base unit 2 drawers+1 deep drawer, base unit 2 deep drawers and base unit 4 drawers</p>								
	opz.101		+55	+55				
 <p><b>base predisposta piano cottura con cappa integrata</b> <b>1 frontale superiore fisso H 18</b> <b>1 cassetto H 18 P 40</b> <b>1 cestone H 36 P 40</b> base unit configured for cooker hob with integrated hood 1 fixed upper front H 18 1 drawer H 18 D 40 1 deep drawer H 36 D 40</p>	L 90	E5509090	443	503				
			+15	+20				
			+50	+65				
<p><b>mag.cestone con intarsio</b> surcharge for deep drawer with inlaid</p> <p><b>mag.cestone con decoro metallico</b> surcharge for deep drawer with metallic decor</p>								
 <p><b>base predisposta piano cottura con cappa integrata</b> <b>1 anta vasistas H 36</b> <b>1 cestone H 36 P 40</b> base unit configured for cooker hob with integrated hood 1 flap door H 36 1 deep drawer H 36 D 40</p>	L 90	E5509095	514	574				
			+15	+20				
			+50	+65				
<p><b>mag.anta/cestone con intarsio cad.</b> surch.door/deep drawer with inlaid each</p> <p><b>mag.anta/cestone con decoro metallico cad.</b> surch.door/deep drawer with metallic decor each</p>								
 <p><b>Esempio di piano cottura con cappa integrata</b> Example of cooker hob with integrated hood</p>								

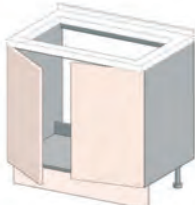
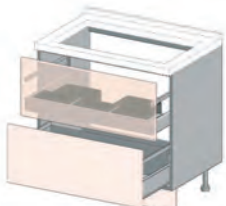
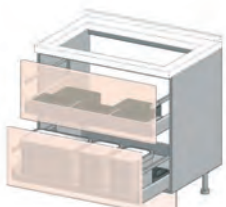
**LE BASI NON SONO COMPRENSIVE DI TOP**  
THE BASE UNITS DO NOT INCLUDE THE TOPS

		COD.	FASCIA A K70	FASCIA B K70				
 <p><b>sottolavello 1 anta</b> sink base unit 1 door</p>	L 45	E5010451/2	171	194				
	L 60	E5010601/2	198	227				
			+15	+20				
			+50	+65				
			<p><b>mag.anta con intarsio</b> surcharge for door with inlaid</p> <p><b>mag.anta con decoro metallico</b> surcharge for door with metallic decor</p>					
 <p><b>sottolavello 2 ante</b> sink base unit 2 doors</p>	L 60	E5010600	249	287				
	L 80	E5010800	278	321				
	*L 90	E5010900	285	330				
	*L 120	E5011200	344	401				
			+30	+40				
			<p><b>*mag.ante con intarsio</b> surcharge for doors with inlaid</p> <p><b>*mag.ante con decoro metallico</b> surcharge for doors with metallic decor</p>					
		+100	+130					
 <p><b>sottolavello 2 cestoni H 36</b> <b>cestone superiore sagomato con vaschette</b> sink base unit 2 deep drawers H 36 contoured upper deep drawer with trays</p>	L 60	E5200600	391	428				
	L 90	E5200900	444	493				
			+15	+20				
			+50	+65				
			<p><b>mag.cestone con intarsio cad.</b> surcharge for deep drawer with inlaid each</p> <p><b>mag.cestone con decoro metallico cad.</b> surcharge for deep drawer with metallic decor each</p>					
 <p><b>sottolavello 1 cestone superiore sagomato con vaschette</b> <b>1 cestone inferiore con pattumiere integrate</b> sink base unit 1 contoured upper deep drawer with trays 1 lower deep drawer with integrated waste bins</p>	L 60	E520060P	462	499				
	L 90	E520090P	516	565				
			+15	+20				
			+50	+65				
			<p><b>mag.cestone con intarsio cad.</b> surcharge for deep drawer with inlaid each</p> <p><b>mag.cestone con decoro metallico cad.</b> surcharge for deep drawer with metallic decor each</p>					
 <p><b>sottolavello 2 ante e fascia sagomata</b> sink base unit 2 doors and band shaped</p>	L 90	E5030900	415	501				
	L 120	E5031200	481	584				

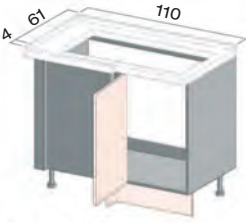
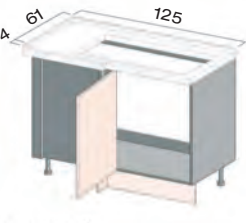
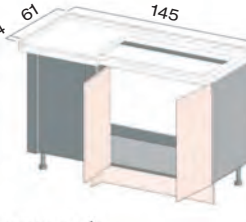
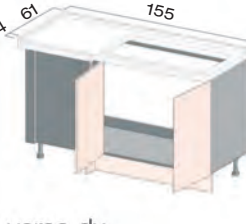
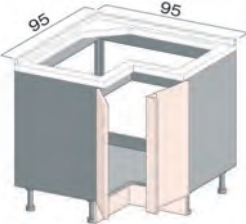
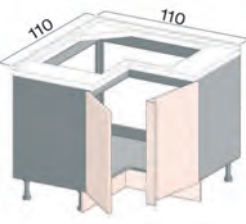





LE BASI NON SONO COMPRENSIVE DI TOP THE BASE UNITS DO NOT INCLUDE THE TOPS		COD.	FASCIA A K70	FASCIA B K70				
 <p><b>sottolavello angolo L 110</b>  <b>1 anta L 45</b>  <b>cassone 105</b>                      corner sink base unit W 110                      1 door W 45                      structure 105</p> <p>verso dx RH version</p>	<b>110x65</b>	E4421101/2	297	339				
			+15	+20				
			+50	+65				
 <p><b>sottolavello angolo L 125</b>  <b>1 anta L 60</b>  <b>cassone 120</b>                      corner sink base unit W 125                      1 door W 60                      structure 120</p> <p>verso dx RH version</p>	<b>125x65</b>	E4421251/2	328	377				
			+15	+20				
			+50	+65				
 <p><b>sottolavello angolo L 145</b>  <b>2 ante L 40</b>  <b>cassone 140</b>                      corner sink base unit W 145                      2 doors W 40                      structure 140</p> <p>verso dx RH version</p>	<b>145x65</b>	E4421451/2	402	465				
 <p><b>sottolavello angolo L 155</b>  <b>2 ante L 45</b>  <b>cassone 150</b>                      corner sink base unit W 155                      2 doors W 45                      structure 150</p> <p>verso dx RH version</p>	<b>155x65</b>	E4421551/2	414	479				
			+30	+40				
			+100	+130				
 <p><b>sottolavello angolo 95x95</b>  <b>2 ante L 30 con angolare</b>                      corner sink base unit 95x95                      2 doors W 30 with angular</p>	<b>95x95</b>	E5021950	614	671				
 <p><b>sottolavello angolo 110x110</b>  <b>2 ante L 45 con angolare</b>                      corner sink base unit 110x110                      2 doors W 45 with angular</p>	<b>110x110</b>	E5022100	649	713				
			+30	+40				
			+100	+130				

# BASI PER ELETTRODOMESTICI SOTTOTOP

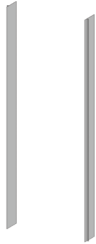
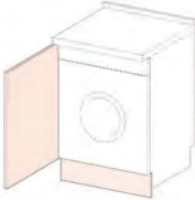

H 87 P 59,9

BASE UNITS FOR UNDER-TOP APPLIANCES

**LE BASI NON SONO COMPRENSIVE DI TOP**  
THE BASE UNITS DO NOT INCLUDE THE TOPS

	COD.	FASCIA A K70	FASCIA B K70				
 <p><b>anta per lavastoviglie scomparsa totale completa di kit protezione fianchi</b> door for fully integrated dishwasher with protection kit for side panels</p>	L 45	E4490080	106	130			
	L 60	E4490090	148	165			
 <p><b>anta per lavastoviglie scomparsa totale estetica 2 cestoni completa di kit protezione fianchi</b> door for fully integrated dishwasher 2 deep drawers aesthetic with protection kit for side panels</p>	L 60	E4490100	173	213			
	L 45	E4490050	94	116			
 <p><b>anta per lavastoviglie comandi a vista completa di kit protezione fianchi</b> door for dishwasher with visible controls with protection kit for side panels</p>	L 60	E4490060	118	146			
 <p><b>kit protezione fianchi per lavastoviglie</b> protection kit for side panels for dishwasher</p> 							
 <p><b>anta per lavabiancheria scomparsa totale</b> door for fully integrated washing machine</p>	L 60	E4490011/2	148	165			
	L 60	E4490151/2	173	190			
 <p><b>anta con fianco per frigo e congelatore sottotop</b> door with side panel for under-top fridge and freezer</p>							



<b>LE BASI NON SONO COMPRENSIVE DI TOP</b> THE BASE UNITS DO NOT INCLUDE THE TOPS	COD.	<b>FASCIA A</b> K70	<b>FASCIA B</b> K70				
 <p><b>anta per frigo e congelatore sottotop</b> door for under-top fridge and freezer</p>							
 <p><b>fianco per elettrodomestici a fine composizione</b> side panel for appliances placed at the end of the composition</p>	L 60	E4490181/2	148	165			

**in nobilitato**  
melamine coated  
**H 87x59,9x2 zoccolo H 15**  
H 87x59,9x2 plinth H 15

T94615

25

25

**impiallacciato**  
veneered  
**H 87x59,9x2,2 zoccolo H 15**  
H 87x59,9x2,2 plinth H 15

T94725

176



183

# BASI RIBASSATE H 75

H 75 P 59,9

LOWERED BASE UNITS H 75

**LE BASI NON SONO COMPRENSIVE DI TOP**  
THE BASE UNITS DO NOT INCLUDE THE TOPS

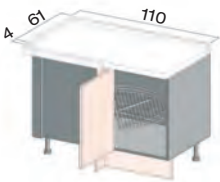
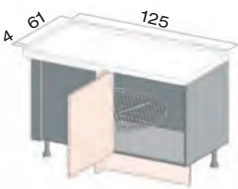
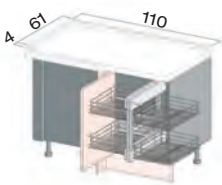
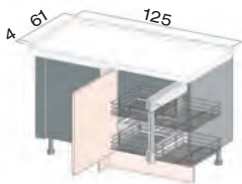
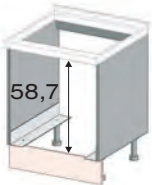
	COD.	FASCIA A K70	FASCIA B K70			
 <p><b>base H 75</b> <b>1 anta</b> base unit H 75 1 door</p>	L 45	E4030451/2	178	199		
	L 60	E4030601/2	203	230		
 <p><b>base H 75</b> <b>2 ante</b> base unit H 75 2 doors</p>	L 90	E4030900	296	338		
	 <p><b>base angolo H 75 L 110</b> <b>1 cestello mezzaluna orion grau</b> <b>1 anta L 45</b> <b>cassone 105</b> corner base unit H 75 W 110 1 crescent-shaped orion grau wire basket unit 1 door W 45 structure 105</p> <p>verso dx RH version</p>	110x65	E4391101/2	325	366	
 <p><b>base angolo H 75 L 125</b> <b>1 cestello mezzaluna orion grau</b> <b>1 anta L 60</b> <b>cassone 120</b> corner base unit H 75 W 125 1 crescent-shaped orion grau wire basket unit 1 door W 60 structure 120</p> <p>verso dx RH version</p>		125x65	E4391251/2	348	394	
	 <p><b>base angolo H 75 L 110</b> <b>4 cestelli orion grau estraibili indipendenti dall'anta</b> <b>1 anta L 45</b> <b>cassone 105</b> corner base unit H 75 W 110 4 pull-out orion grau basket units opening independently from door 1 door W 45 structure 105</p> <p>verso dx RH version</p>	110x65	E4392101/2	835	876	
 <p><b>base angolo H 75 L 125</b> <b>4 cestelli orion grau estraibili indipendenti dall'anta</b> <b>1 anta L 60</b> <b>cassone 120</b> corner base unit H 75 W 125 4 pull-out orion grau basket units opening independently from door 1 door W 60 structure 120</p> <p>verso dx RH version</p>		125x65	E4392251/2	908	954	
	 <p><b>base H 75 predisposta per forno H 60</b> base unit H 75 configured for oven H 60</p>	L 60	E5540600	115	115	

# LAVELLO IN CERAMICA PORCELLANATA DI BLANCO

BLANCO PORCELAIN CERAMIC SINK BASE UNIT

**LE BASI NON SONO COMPRENSIVE DI TOP**  
THE BASE UNITS DO NOT INCLUDE THE TOPS

COD.

**FASCIA  
A**  
K70

**FASCIA  
B**  
K70

**sottolavello H 75**  
**1 anta**  
skin base unit H 75  
1 door

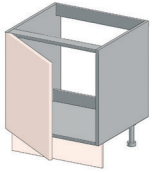

L 60

E5060601/2

201

227

**lavello ceramica L 59,8 P 63 H 22**  
**1 vasca con foro rubinetto**  
**colore bianco**

ceramic sink W 59,8 P 63 H 22  
1 bowl sink with hole of the tap  
white colour



07069910

1.133

1.133

**Disegno tecnico**  
Technical drawing

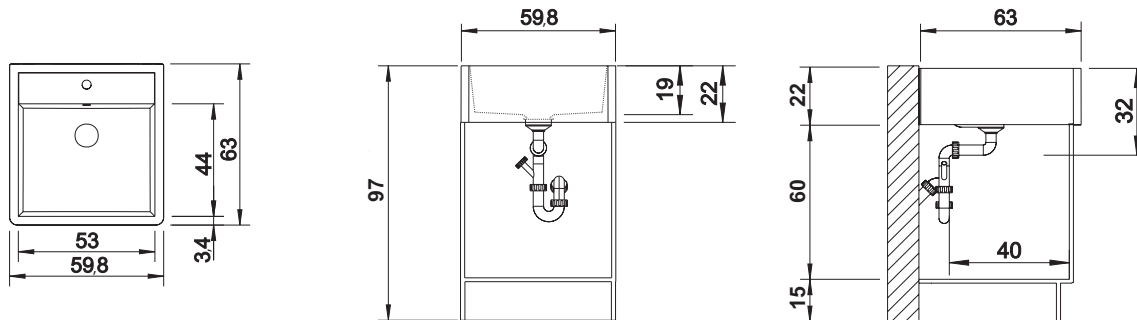











# BASI SOSPENSE con Attaccaglie e Barre Fissaggio a parete

H 36 - 48 - 60 P 61



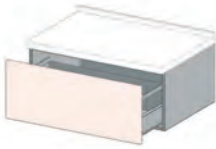

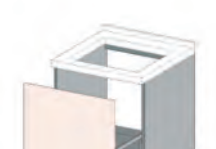
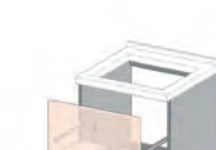

HANGING BASE UNITS with Hangers and Rods for wall mounting

**LE BASI NON SONO COMPRENSIVE DI TOP**  
THE BASE UNITS DO NOT INCLUDE THE TOPS

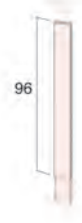
		COD.	FASCIA A K70	FASCIA B K70				
 <p><b>base H 36</b> <b>1 anta</b> base unit H 36 1 door</p>	L 45	E4321451/2	166	183				
	L 60	E4321601/2	179	198				
			+15	+20				
			+50	+65				
			<p><b>mag.anta con intarsio</b> surcharge for door with inlaid</p> <p><b>mag.anta con decoro metallico</b> surcharge for door with metallic decor</p>					
 <p><b>base H 48</b> <b>1 anta</b> base unit H 48 1 door</p>	L 45	E4320451/2	186	205				
	L 60	E4320601/2	201	222				
 <p><b>base H 60</b> <b>1 anta</b> base unit H 60 1 door</p>	L 45	E4322451/2	186	207				
	L 60	E4322601/2	211	237				
 <p><b>base H 36</b> <b>2 ante</b> base unit H 36 2 doors</p>	L 90	E4321900	255	290				
			+30	+40				
			+100	+130				
			<p><b>mag.ante con intarsio</b> surcharge for doors with inlaid</p> <p><b>mag.ante con decoro metallico</b> surcharge for doors with metallic decor</p>					
 <p><b>base H 48</b> <b>2 ante</b> base unit H 48 2 doors</p>	L 90	E4320900	292	330				
 <p><b>base H 60</b> <b>2 ante</b> base unit H 60 2 doors</p>	L 90	E4322900	296	337				

LE BASI NON SONO COMPRENSIVE DI TOP THE BASE UNITS DO NOT INCLUDE THE TOPS		COD.	FASCIA A K70	FASCIA B K70					
 <p><b>base H 36</b> <b>1 cestone</b> base H 36 1 deep drawer</p>	L 45	E4311450	215	233					
	L 60	E4311600	230	249					
	L 90	E4311900	268	292					
				+15	+20				
				+50	+65				
<p><b>mag.cestone con intarsio</b> surcharge for deep drawer with inlaid</p> <p><b>mag.cestone con decoro metallico</b> surcharge for deep drawer with metallic decor</p>									
 <p><b>base H 48</b> <b>1 cestone</b> base unit H 48 1 deep drawer</p>	L 45	E4310450	228	247					
	L 60	E4310600	245	266					
	L 90	E4310900	296	328					
 <p><b>base H 60</b> <b>1 cestone</b> <b>1 cassetto interno</b> base unit H 60 1 deep drawer 1 internal drawer</p>	L 45	E4312450	321	342					
	L 60	E4312600	352	378					
 <p><b>sottolavello H 48</b> <b>1 cestone sagomato scarico salvaspazio</b> sink base unit H 48 1 contoured deep drawer space-saver drain piping</p>	L 90	E5240900	325	357					
 <p><b>sottolavello H 60</b> <b>1 cestone scarico salvaspazio</b> sink base unit H 60 1 deep drawer with space-saver drain piping</p>	L 60	E5250600	279	305					
 <p><b>sottolavello H 60</b> <b>1 cestone con pattumiera integrata scarico salvaspazio</b> skin base unit H 60 1 deep drawer with incorporated waste bins space-saver drain piping</p>	L 60	E525060P	372	398					



LE COLONNE NON SONO COMPRENSIVE DI TOP THE COLUMNS DO NOT INCLUDE THE TOPS		COD.	FASCIA A K70	FASCIA B K70				
 <p><b>fascia tamponamento da 5 a 10</b> filler panel size from 5 to 10</p>								
	<p><b>in nobilitato</b> melamine coated</p>	E6000010	50	50				
	<p><b>come anta con supporto</b> same as door with support</p>	E6000140	97	111				
 <p><b>1 anta</b> 1 door</p>								
	L 30	E6040301/2	227	243				
	L 40	E6040401/2	243	273				
	*L 45	E6040451/2	251	283				
	*L 60	E6040601/2	288	327				
	<b>*mag.anta con decoro metallico</b> surcharge for door with metallic decor		+50	+65				
 <p><b>2 ante</b> <b>2 ripiani con tirante centrale</b> 2 doors 2 shelves with central tie beam</p>								
	L 90	E6041900	422	487				
		<b>mag.ante con decoro metallico</b> surcharge for doors with metallic decor		+100	+130			
 <p><b>1 cassetto H 24</b> <b>2 cestoni H 36</b> 1 drawer H 24 2 deep drawers H 36</p>								
	L 60	E6031620	495	549				
 <p><b>1 cassetto H 24</b> <b>1 cestone H 36</b> <b>1 cestone vetro H 36</b> 1 drawer H 24 1 deep drawer H 36 1 glass deep drawer H 36</p>								
	L 60	E6031610	545	612				
 <p><b>1 cassetto H 24</b> <b>2 cestoni vetro H 36</b> 1 drawer H 24 2 glass deep drawers H 36</p>								
	L 60	E6031600	595	674				

**LE COLONNE NON SONO COMPRESIVE DI TOP**  
THE COLUMNS DO NOT INCLUDE THE TOPS

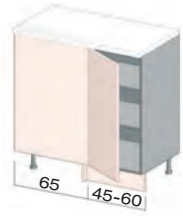

**angolo 2 ripiani**  
**1 anta**  
**pannello impiallacciato sp. 2,2 come anta**  
corner unit 2 shelves  
1 door  
veneered panel Th. 2,2 same as door

L 110

E6327101/2

477

548

L 125

E6327251/2

506

584



**jolly colonna**  
**L da 10 a 30**  
jolly column  
size from 10 to 30

**in nobilitato**  
melamine coated

E6000900

170

170

**impiallacciato**  
veneered

E6005050

467







494



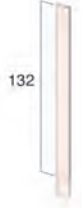











# COLONNE H 147





COLUMNS H 147





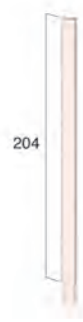

P 33,4 - 59,9

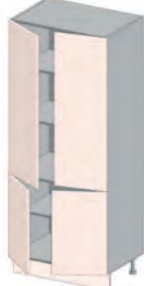





LE COLONNE NON SONO COMPRENSIVE DI TOP THE COLUMNS DO NOT INCLUDE THE TOPS		COD.	FASCIA A K70	FASCIA B K70				
 <p><b>fascia tamponamento da 5 a 10</b> filler panel size from 5 to 10</p>								
	<p><b>in nobilitato</b> melamine coated</p>	E6000020	51	51				
	<p><b>come anta con supporto</b> same as door with support</p>	E6000150	143	171				
 <p><b>1 anta</b> 1 door</p>								
	L 30	E6050301/2	281	306				
	L 45	E6050451/2	303	344				
	*L 60	E6050601/2	342	392				
	<p><b>*mag.anta con decoro metallico</b> surcharge for door with metallic decor</p>		+50	+65				
 <p><b>2 ante</b> <b>2 ripiani con tirante centrale</b> 2 doors 2 shelves with central tie beam</p>								
	L 90	E6050900	520	603				
 <p><b>1 anta vetro</b> 1 glass door</p>								
	L 45	E6180451/2	372	433				
	L 60	E6180601/2	432	507				
 <p><b>2 ante vetro</b> 2 glass doors</p>								
	L 90	E6180900	665	787				
 <p><b>1 anta vetro</b> 1 glass door</p>								
	L 45 P 33,4	E6180461/2	369	430				
	L 60 P 33,4	E6180611/2	428	503				



LE COLONNE NON SONO COMPRENSIVE DI TOP THE COLUMNS DO NOT INCLUDE THE TOPS		COD.	FASCIA A K70	FASCIA B K70				
 <p><b>2 ante vetro</b> 2 glass doors</p>	L 90 P 33,4	E6180910	629	751				
 <p><b>1 anta integrata al gruppo cestelli estraibili in filo orion grau</b> <b>chiusura soft</b> 1 door incorporated into the orion grau wire pull-out basket units soft-closing system</p>	L 30	E6150300	523	547				
 <p><b>1 anta</b> <b>gruppo cestelli estraibili in filo orion grau</b> <b>chiusura soft</b> 1 door orion grau wire pull-out basket units soft-closing system</p>	L 45 L 60	E6150451/2	550	589				
		E6150601/2	604	651				
			+50	+65				
		<b>mag.anta con decoro metallico</b> surcharge for door with metallic decor						
 <p><b>1 anta vetro</b> <b>gruppo cestelli estraibili in filo orion grau</b> <b>chiusura soft</b> 1 glass door orion grau wire pull-out basket units soft-closing system</p>	L 45 L 60	E6152451/2	640	702				
		E6152601/2	719	795				
 <p><b>angolo 2 ripiani con tirante centrale</b> <b>1 anta</b> <b>pannello impiallacciato sp.2,2 come anta</b> corner unit 2 shelves with central tie beam 1 door veneered panel Th. 2,2 same as door</p>	L 110 L 125	E6336101/2	577	672				
		E6336251/2	605	708				
 <p><b>jolly colonna</b> <b>L da 10 a 30</b> jolly column size from 10 to 30</p>	<b>in nobilitato</b> melamine coated  <b>impiallacciato</b> veneered	E6001000	203	203				
		E6005100	483	511				





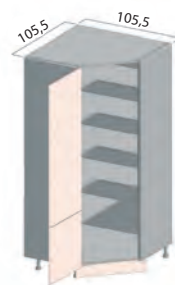

LE COLONNE NON SONO COMPRENSIVE DI TOP THE COLUMNS DO NOT INCLUDE THE TOPS		COD.	FASCIA A K70	FASCIA B K70				
 <p><b>1 anta con lavagna magnetica superiore e pannello inferiore</b> <b>2 ripiani</b> <b>N.B.: non disponibile per le finiture grigio reale (opz.2454) e bianco artico (opz.2491)</b> 1 door with upper magnetic blackboard and lower panel 2 shelves <b>Note: not available for royal grey (opt.2454) and arctic white (opt.2491)</b></p>	L 45	E6050451/2	539	—				
	L 60	E6050601/2	669	—				
 <p><b>2 ante con lavagna magnetica superiore e pannello inferiore</b> <b>2 ripiani</b> <b>N.B.: non disponibile per le finiture grigio reale (opz.2454) e bianco artico (opz.2491)</b> 2 doors with upper magnetic blackboard and lower panel 2 shelves <b>Note: not available for royal grey (opt.2454) and arctic white (opt.2491)</b></p>	L 90	E6050900	992	—				
	 <p><b>cestelli estraibili orion grau</b> <b>1 anta con lavagna magnetica superiore e pannello inferiore</b> <b>chiusura soft</b> <b>N.B.: non disponibile per le finiture grigio reale (opz.2454) e bianco artico (opz.2491)</b> orion grau pull-out basket units 1 door with upper magnetic blackboard and lower panel soft-closing system <b>Note: not available for royal grey (opt.2454) and arctic white (opt.2491)</b></p>	L 45	E6150451/2	786	—			
L 60		E6150601/2	931	—				
 <p><b>1 anta con vetro superiore e pannello inferiore</b> <b>2 ripiani</b> 1 door with upper glass and lower panel 2 shelves</p>	L 45	E6180471/2	363	423				
	L 60	E6180621/2	417	491				
 <p><b>2 ante con vetro superiore e pannello inferiore</b> <b>2 ripiani</b> 2 doors with upper glass and lower panel 2 shelves</p>	L 90	E6180920	646	767				
	 <p><b>cestelli estraibili orion grau</b> <b>1 anta con vetro superiore e pannello inferiore</b> <b>chiusura soft</b> orion grau pull-out basket units 1 door with upper glass and lower panel soft-closing system</p>	L 45	E6152471/2	631	692			
L 60		E6152621/2	704	778				

	COD.	FASCIA A K70	FASCIA B K70			
 <p><b>fascia tamponamento da 5 a 10</b> filler panel size from 5 to 10</p> <p>204</p>						
	<p><b>in nobilitato</b> melamine coated</p>	E6000050	58	58		
	<p><b>come anta con supporto</b> same as door with support</p>	E6000200	172	206		
 <p><b>2 ante</b> <b>anta superiore H 72</b> <b>anta inferiore H 132</b> 2 doors upper door H 72 lower door H 132</p>						
	<p>L 45 P 33,4</p>	E6013451/2	435	502		
	<p>*L 60 P 33,4</p>	E6013601/2	507	591		
	<p><b>*mag. ante con decoro metallico</b> surcharge for doors with metallic decor</p>		+100	+130		
 <p><b>2 ante</b> <b>anta superiore H 72</b> <b>anta inferiore H 132</b> 2 doors upper door H 72 lower door H 132</p>						
	<p>L 30 P 59,9</p>	E6060301/2	412	458		
	<p>L 45 P 59,9</p>	E6063451/2	448	514		
	<p>*L 60 P 59,9</p>	E6063601/2	526	611		
	<p><b>*mag. ante con decoro metallico</b> surcharge for doors with metallic decor</p>		+100	+130		
 <p><b>2 ante</b> <b>anta superiore H 132</b> <b>anta inferiore H 72</b> 2 doors upper door H 132 lower door H 72</p>						
	<p>L 45 P 33,4</p>	E6010451/2	435	502		
	<p>*L 60 P 33,4</p>	E6010601/2	507	591		
	<p><b>*mag. ante con decoro metallico</b> surcharge for doors with metallic decor</p>		+100	+130		
 <p><b>2 ante</b> <b>anta superiore H 132</b> <b>anta inferiore H 72</b> 2 doors upper door H 132 lower door H 72</p>						
	<p>L 45 P 59,9</p>	E6060451/2	448	514		
	<p>*L 60 P 59,9</p>	E6060601/2	526	611		
	<p><b>*mag. ante con decoro metallico</b> surcharge for doors with metallic decor</p>		+100	+130		
 <p><b>4 ante</b> <b>2 ante superiori H 132</b> <b>2 ante inferiori H 72</b> <b>4 ripiani con tirante centrale</b> 4 doors 2 upper doors H 132 2 lower doors H 72 4 shelves with central tie beam</p>						
	<p>L 90 P 59,9</p>	E6060900	760	888		

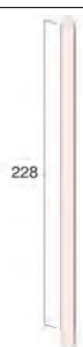





		COD.	FASCIA A K70	FASCIA B K70				
 <p><b>portascope</b> 2 ante anta superiore H 72 anta inferiore H 132 broom cabinet 2 doors upper door H 72 lower door H 132</p>	L 30	E6100301/2	421	458				
	L 45	E6100451/2	440	507				
 <p><b>portascope con ripiani</b> 2 ante anta superiore H 72 anta inferiore H 132 broom cabinet with shelves 2 doors upper door H 72 lower door H 132</p>	L 60	E6100601/2	538	622				
			+100	+130				
<p><i>*mag. ante con decoro metallico</i> surcharge for doors with metallic decor</p>								
 <p><b>1 anta H 132</b> <b>4 cassetti H 18</b> 1 door H 132 4 drawers H 18</p>	L 45	E6065451/2	646	743				
	L 60	E6065601/2	719	818				
 <p><b>1 anta H 132</b> <b>2 cassetti H 18</b> <b>1 cestone H 36</b> 1 door H 132 2 drawers H 18 1 deep drawer H 36</p>	L 45	E6065461/2	603	688				
	L 60	E6065611/2	668	759				
			+15	+20				
			+50	+65				
<p><i>mag. cestone con intarsio</i> surcharge for deep drawer with inlaid</p> <p><i>mag. cestone con decoro metallico</i> surcharge for deep drawer with metallic decor</p>								
 <p><b>1 anta H 132</b> <b>2 cestoni H 36</b> 1 door H 132 2 deep drawers H 36</p>	L 45	E6066451/2	560	633				
	L 60	E6066601/2	617	700				
			+15	+20				
			+50	+65				
<p><i>mag. cestone con intarsio cad.</i> surcharge for deep drawer with inlaid each</p> <p><i>mag. cestone con decoro metallico cad.</i> surcharge for deep drawer with metallic decor each</p>								
 <p><b>jolly colonna</b> <b>L da 15 a 30</b> jolly column size from 15 to 30</p>								
	<b>in nobilitato</b> melamine coated	E6002000	239	239				
	<b>impiallacciato</b> veneered	E6005200	863	912				

		COD.	FASCIA A K70	FASCIA B K70				
 <p><b>2 ante</b> <b>anta vetro H 132</b> <b>anta chiusa H 72</b> 2 doors glass door H 132 full door H 72</p>	L 45 P 33,4	E6202451/2	491	574				
	L 60 P 33,4	E6202601/2	568	672				
 <p><b>2 ante</b> <b>anta vetro H 132</b> <b>anta chiusa H 72</b> 2 doors glass door H 132 full door H 72</p>	L 45 P 59,9	E6201451/2	500	583				
	L 60 P 59,9	E6201601/2	584	687				
 <p><b>4 ante</b> <b>2 ante vetro H 132</b> <b>2 ante chiuse H 72</b> 4 doors 2 glass doors H 132 2 full doors H 72</p>	L 90 P 59,9	E6201900	908	1.074				
 <p><b>1 anta vetro H 132</b> <b>4 cassetti H 18</b> 1 glass door H 132 4 drawers H 18</p>	L 45 P 59,9	E6284451/2	736	854				
	L 60 P 59,9	E6284601/2	833	961				
 <p><b>1 anta vetro H 132</b> <b>2 cassetti H 18</b> <b>1 cestone H 36</b> 1 glass door H 132 2 drawers H 18 1 deep drawer H 36</p>	L 45 P 59,9	E6284611/2	782	902				
	L 60 P 59,9	E6284611/2	782	902				
				+15	+20			
				+50	+65			
 <p><b>1 anta vetro H 132</b> <b>2 cestoni H 36</b> 1 glass door H 132 2 deep drawers H 36</p>	L 45 P 59,9	E6285451/2	649	745				
	L 60 P 59,9	E6285601/2	730	842				
				+15	+20			
				+50	+65			

		COD.	FASCIA A K70	FASCIA B K70				
 <p><b>1 anta superiore H 72</b>  <b>1 anta H 132 integrata al gruppo cestelli estraibili in filo orion grau</b>  <b>chiusura soft</b>                      1 upper door H 72                      1 door H 132 incorporated into the orion grau wire pull-out basket units                      soft-closing system</p>	L 30	E6160301/2	644	687				
 <p><b>1 anta superiore H 72</b>  <b>1 anta inferiore H 132</b>  <b>gruppo cestelli estraibili in filo orion grau</b>  <b>chiusura soft</b>                      1 upper door H 72                      1 lower door H 132                      orion grau wire pull-out basket units                      soft-closing system</p>	L 45	E6160451/2	687	748				
	*L 60	E6160601/2	765	841				
			+100	+130				
 <p><b>angolo 4 ripiani con tirante centrale</b>  <b>1 anta superiore H 72</b>  <b>1 anta inferiore H 132</b>  <b>pannello impiallacciato sp.2,2 come anta</b>                      corner unit 4 shelves with central tie beam                      1 upper door H 72                      1 lower door H 132                      veneered panel Th. 2,2 same as door</p>	L 110	E6306101/2	850	995				
	L 125	E6306251/2	898	1.057				
 <p><b>angolo 1 anta H 204 (132 + 72)</b>  <b>2 fianchi sp. 3,8 come struttura</b>  <b>N.B.: fornita smontata</b>                      corner 1 door H 204 (132 + 72)                      2 side panels Th.3,8 same as carcass                      Note: supplied unassembled</p>	105,5x105,5	E6341051/2	1.098	1.177				
	con fianchi sp.3,8 impiallacciati veneered side Th.3,8							
	105,5x105,5	E6341061/2	1.579	1.708				

		COD.	FASCIA A K70	FASCIA B K70				
 <p><b>fascia tamponamento da 5 a 10</b> filler panel size from 5 to 10</p> <p>228</p>								
	<p><b>in nobilitato</b> melamine coated</p>	E6000100	58	58				
	<p><b>come anta con supporto</b> same as door with support</p>	E6000250	181	219				
 <p><b>2 ante</b> <b>anta superiore H 96</b> <b>anta inferiore H 132</b> 2 doors upper door H 96 lower door H 132</p>	L 45 P 33,4	E6023451/2	483	558				
	L 60 P 33,4	E6023601/2	560	653				
 <p><b>2 ante</b> <b>anta superiore H 96</b> <b>anta inferiore H 132</b> 2 doors upper door H 96 lower door H 132</p>	L 30 P 59,9	E6070301/2	445	496				
	L 45 P 59,9	E6073451/2	497	572				
	L 60 P 59,9	E6073601/2	582	675				
 <p><b>2 ante</b> <b>anta superiore H 156</b> <b>anta inferiore H 72</b> 2 doors upper door H 156 lower door H 72</p>	L 45 P 33,4	E6020451/2	496	574				
	L 60 P 33,4	E6020601/2	579	677				
 <p><b>2 ante</b> <b>anta superiore H 156</b> <b>anta inferiore H 72</b> 2 doors upper door H 156 lower door H 72</p>	L 45 P 59,9	E6070451/2	509	588				
	L 60 P 59,9	E6070601/2	601	700				
 <p><b>4 ante</b> <b>2 ante superiori H 156</b> <b>2 ante inferiori H 72</b> <b>4 ripiani con tirante centrale</b> 4 doors 2 upper doors H 156 2 lower doors H 72 4 shelves with central tie beam</p>	L 90 P 59,9	E6070900	866	1.016				











		COD.	FASCIA A K70	FASCIA B K70				
 <p><b>portascope</b>  <b>1 anta superiore H 96</b>  <b>1 anta inferiore H 132</b>                      broom cabinet                      1 upper door H 96                      1 lower door H 132</p>	L 30	E6110301/2	465	497				
	L 45	E6110451/2	490	565				
 <p><b>portascope con ripiani</b>  <b>1 anta superiore H 96</b>  <b>1 anta inferiore H 132</b>                      broom cabinet with shelves                      1 upper door H 96                      1 lower door H 132</p>	L 60	E6110601/2	580	673				
 <p><b>1 anta H 156</b>  <b>4 cassetti H 18</b>                      1 door H 156                      4 drawers H 18</p>	L 45	E6075451/2	702	810				
	L 60	E6075601/2	785	897				
 <p><b>1 anta H 156</b>  <b>2 cassetti H 18</b>  <b>1 cestone H 36</b>                      1 door H 156                      2 drawers H 18                      1 deep drawer H 36</p>	L 45	E6075461/2	659	755				
	L 60	E6075611/2	734	838				
			+15	+20				
			+50	+65				
 <p><b>1 anta H 156</b>  <b>2 cestoni H 36</b>                      1 door H 156                      2 deep drawers H 36</p>	L 45	E6076451/2	616	700				
	L 60	E6076601/2	683	779				
			+15	+20				
			+50	+65				
 <p><b>jolly colonna</b>  <b>L da 15 a 30</b>                      jolly column                      size from 15 to 30</p>								
	<b>in nobilitato</b> melamine coated	E6003000	267	267				
	<b>impiallacciato</b> veneered	E6005250	902	960				

# COLONNE H 243





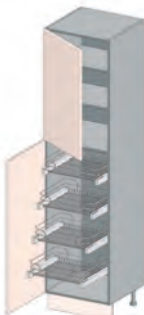

COLUMNS H 243

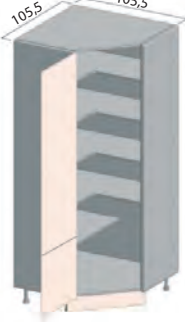
P 33,4 - 59,9

		COD.	FASCIA A K70	FASCIA B K70				
 <p><b>2 ante</b> <b>anta vetro con bugna H 156</b> <b>anta chiusa H 72</b> 2 doors glass door with rise panel H 156 full door H 72</p>	L 45 P 33,4	E6212451/2	565	667				
 <p><b>2 ante</b> <b>anta vetro con bugna H 156</b> <b>anta chiusa H 72</b> 2 doors glass door with rise panel H 156 full door H 72</p>	L 45 P 59,9	E6211451/2	577	679				
 <p><b>4 ante</b> <b>2 ante vetro con bugna H 156</b> <b>2 ante chiuse H 72</b> 4 doors 2 glass doors with rise panel H 156 2 full doors H 72</p>	L 90 P 59,9	E6211900	1.050	1.253				
 <p><b>1 anta vetro con bugna H 156</b> <b>4 cassetti H 18</b> 1 glass door with rise panel H 156 4 drawers H 18</p>	L 45 P 59,9	E6294451/2	813	950				
 <p><b>1 anta vetro con bugna H 156</b> <b>2 cassetti H 18</b> <b>1 cestone H 36</b> 1 glass door with rise panel H 156 2 drawers H 18 1 deep drawer H 36</p>	L 45 P 59,9	E6294461/2	770	895				
				+15	+20			
				+50	+65			
 <p><b>1 anta vetro con bugna H 156</b> <b>2 cestoni H 36</b> 1 glass door with rise panel H 156 2 deep drawers H 36</p>	L 45 P 59,9	E6295451/2	726	840				
				+15	+20			
				+50	+65			

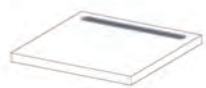
		COD.	FASCIA A K70	FASCIA B K70				
 <p><b>1 anta superiore H 96</b>  <b>1 anta H 132 integrata al gruppo cestelli estraibili in filo orion grau</b>  <b>chiusura soft</b>                      1 upper door H 96                      1 door H 132 incorporated into the orion grau wire pull-out basket units                      soft-closing system</p>	L 30	E6170301/2	676	723				
	 <p><b>1 anta superiore H 96</b>  <b>1 anta inferiore H 132</b>  <b>gruppo cestelli estraibili in filo orion grau</b>  <b>chiusura soft</b>                      1 upper door H 96                      1 lower door H 132                      orion grau wire pull-out basket units                      soft-closing system</p>	L 45	E6170451/2	732	802			
L 60		E6170601/2	815	899				
 <p><b>1 anta superiore H 96</b>  <b>1 anta inferiore H 132</b>  <b>4 cestelli orion grau estraibili singolarmente</b>  <b>chiusura soft</b>                      1 upper door H 96                      1 lower door H 132                      4 independent orion grau basket units                      soft-closing system</p>		L 45	E6175451/2	748	818			
	L 60	E6175601/2	827	911				

	COD.	FASCIA A K70	FASCIA B K70				
 <p><b>angolo 5 ripiani con tirante centrale</b>  <b>1 anta superiore H 96</b>  <b>1 anta inferiore H 132</b>  <b>pannello impiallacciato sp. 2,2 come anta</b>                      corner unit 5 shelves with central tie beam                      1 upper door H 96                      1 lower door H 132                      veneered panel Th. 2,2 same as door</p>	<b>L 110 P 59,9</b>	E6316101/2	932	1.098			
	<b>L 125 P 59,9</b>	E6316251/2	987	1.168			
 <p><b>angolo 1 anta H 228 (156+72)</b>  <b>2 fianchi sp. 3,8 come struttura</b>  <b>N.B.: fornita smontata</b>                      corner 1 door H 228 (156+72)                      2 side panels Th.3,8 same as carcass                      Note: supplied unassembled</p>	<b>105,5x105,5</b>	E6342051/2	1.216	1.308			
	<b>con fianchi sp.3,8 impiallacciati</b> veneered side th.3,8 <b>105,5x105,5</b>	E6342061/2	1.676	1.818			

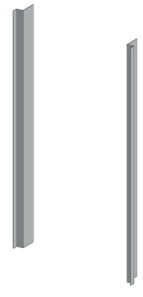

LE COLONNE NON SONO COMPRENSIVE DI TOP THE COLUMNS UNITS DO NOT INCLUDE THE TOPS		COD.	FASCIA A K70	FASCIA B K70					
 <p><b>colonna H 111 per forno 2 cassetti H 18</b> oven column H 111 2 drawers H 18</p>	L 60	E6501660	325	351					
	 <p><b>colonna H 111 per forno 1 cestone chiuso H 36</b> oven column H 111 1 full deep drawer H 36</p>	L 60	E6501600	274	292				
			+15	+20					
			+50	+65					
 <p><b>colonna H 111 per forno 1 cestone vetro H 36</b> oven column H 111 1 glass deep drawer H 36</p>	L 45	E6501610	324	355					
	 <p><b>top in laminato H 4 P 61 per colonne</b> lamine top H 4 D 61 for columns</p>			VEDI	VEDI				
		al ml per lm	T90135	LISTINO	LISTINO				
		<b>mag.griglia di areazione cad.</b> surcharge for ventilation grille each		TOP	TOP				
 <p><b>profilo in acciaio a "L" per rifinire il ripiano del forno e del microonde</b> L-shaped steel finishing profile for shelf of oven and microwave</p> 	L 60								
		inox stainless steel	08660100	9	9				
		nero black	08660101	9	9				
		bianco white	08660102	9	9				
 <p><b>kit protezione fianchi per forno</b> protection kit sides for oven</p> 	L 90								
		inox stainless steel	08660105	12	12				
	coppia couple	08630095	16	16					





# COLONNE PER FORNO H 147



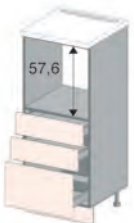
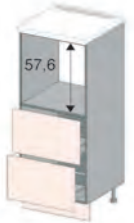
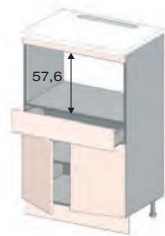
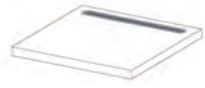

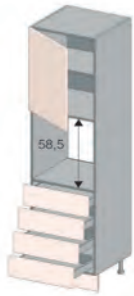
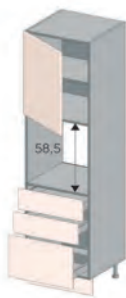
P 59,9

OVEN COLUMNS H 147

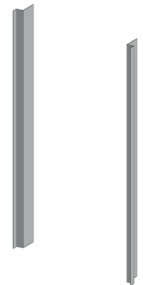

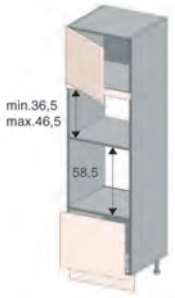

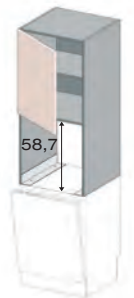
**LE COLONNE NON SONO COMPRENSIVE DI TOP**  
THE COLUMNS UNITS DO NOT INCLUDE THE TOPS

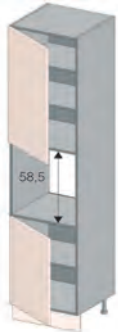
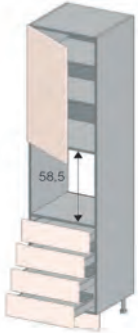
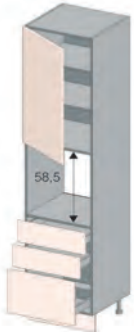
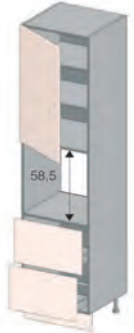

	COD.	FASCIA A K70	FASCIA B K70				
 <p><b>colonna H 147 per forno</b> <b>1 anta H 72</b> oven column H 147 1 door H 72</p>	L 60	E6520601/2	291	321			
			+15	+20			
			+50	+65			
<p><b>mag.anta con intarsio</b> surcharge for door with inlaid</p> <p><b>mag.anta con decoro metallico</b> surcharge for door with metallic decor</p>							
 <p><b>colonna H 147 per forno</b> <b>4 cassetti H 18</b> oven column H 147 4 drawers H 18</p>	L 60	E6521610	527	580			
	<p><b>colonna H 147 per forno</b> <b>2 cassetti H 18</b> <b>1 cestone H 36</b> oven column H 147 2 drawers H 18 1 deep drawer H 36</p>						
 <p><b>colonna H 147 per forno</b> <b>2 cassetti H 18</b> <b>1 cestone H 36</b> oven column H 147 2 drawers H 18 1 deep drawer H 36</p>	L 60	E6521620	476	521			
			+15	+20			
			+50	+65			
<p><b>mag.cestone con intarsio</b> surcharge for deep drawer with inlaid</p> <p><b>mag.cestone con decoro metallico</b> surcharge for deep drawer with metallic decor</p>							
 <p><b>colonna H 147 per forno</b> <b>2 cestoni H 36</b> oven column H 147 2 deep drawers H 36</p>	L 60	E6521630	428	465			
			+15	+20			
			+50	+65			
<p><b>mag.cestone con intarsio cad.</b> surcharge for deep drawer with inlaid each</p> <p><b>mag.cestone con decoro metallico cad.</b> surcharge for deep drawer with metallic decor each</p>							
 <p><b>colonna H 147 per forno per maxiforno H 48</b> <b>1 cassetto H 18</b> <b>2 ante H 60</b> oven column H 147 for maxi-oven H 48 1 drawer H 18 2 doors H 60</p>	L 90	E6521910	516	587			
	<p><b>top in laminato H 4</b> <b>P 61 per colonne</b> laminated top H 4 D 61 for columns</p>						
			VEDI	VEDI			
		T90135	LISTINO	LISTINO			
			TOP	TOP			
<p><b>al ml</b> per 1m</p> <p><b>mag.griglia di areazione cad.</b> surcharge for ventilation grille each</p>							

		COD.	FASCIA A K70	FASCIA B K70			
 <p><b>colonna per forno</b>  <b>1 anta superiore H 72</b>  <b>1 anta inferiore H 72</b>                      oven column                      1 upper door H 72                      1 lower door H 72</p>	L 60	E6530601/2	460	520			
	 <p><b>colonna per forno</b>  <b>1 anta H 72</b>  <b>4 cassetti H 18</b>                      oven column                      1 door H 72                      4 drawers H 18</p>	L 60	E6531611/2	707	788		
 <p><b>colonna per forno</b>  <b>1 anta H 72</b>  <b>2 cassetti H 18</b>  <b>1 cestone H 36</b>                      oven column                      1 door H 72                      2 drawers H 18                      1 deep drawer H 36</p>		L 60	E6531621/2	655	729		
			+15	+20			
			+50	+65			
 <p><b>colonna per forno</b>  <b>1 anta H 72</b>  <b>2 cestoni H 36</b>                      oven column                      1 door H 72                      2 deep drawers H 36</p>	L 60	E6531631/2	604	670			
			+15	+20			
			+50	+65			
 <p><b>profilo in acciaio a "L" per rifinire il ripiano del forno e del microonde</b>                      L-shaped steel finishing profile for shelf of oven and microwave</p> 	L 60						
	inox stainless steel	08660100	9	9			
	nero black	08660101	9	9			
	bianco white	08660102	9	9			
 <p><b>kit protezione fianchi per forno</b>                      protection kit sides for oven</p> 	coppia couple	08630095	16	16			

	COD.	FASCIA A K70	FASCIA B K70				
 <p> <b>colonna per forno e micro</b>  <b>1 anta superiore H 48</b>  <b>vano micro da H 36,5 a 46,5</b>  <b>cestone H 48</b>                      oven and microwave column                      1 upper door H 48                      microwave compartment H 36,5 to 46,5                      deep drawer H 48                 </p>	L 60	E6551601/2	544	603			
 <p> <b>colonna per forno</b>  <b>1 anta superiore H 48</b>  <b>1 anta H 48 sollevamento verticale</b>  <b>1 cestone H 48</b>                      oven column                      1 upper door H 48                      1 door H 48 vertical opening                      1 deep drawer H 48                 </p>	L 60	E6554601/2	726	793			
 <p> <b>colonna forno sospesa H 132 per lavastoviglie</b>  <b>1 anta H 72</b>                      hanging oven column H 132 for dishwasher                      1 door H 72                 </p>	L 60	E6576601/2	318	348			
 <p> <b>fianco per elettrodomestici a fine composizione</b>                      side panel for appliances placed at the end of the composition                 </p>							
	come anta same as door <b>H 219x59,9x2,2</b>	T94572	298	316			

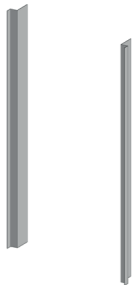

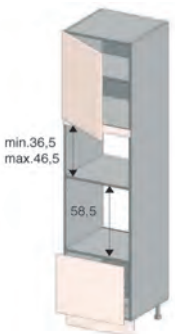
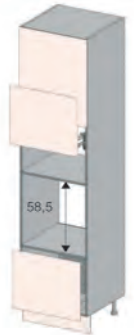
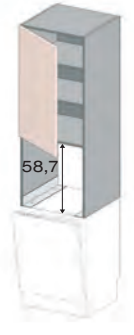
		COD.	FASCIA A K70	FASCIA B K70			
 <p><b>colonna per forno</b>  <b>1 anta superiore H 96</b>  <b>1 anta inferiore H 72</b>                      oven column                      1 upper door H 96                      1 lower door H 72</p>	L 60	E6540601/2	513	581			
	 <p><b>colonna per forno</b>  <b>1 anta H 96</b>  <b>4 cassetti H 18</b>                      oven column                      1 door H 96                      4 drawers H 18</p>	L 60	E6541611/2	758	847		
 <p><b>colonna per forno</b>  <b>1 anta superiore H 96</b>  <b>2 cassetti H 18</b>  <b>1 cestone H 36</b>                      oven column                      1 upper door H 96                      2 drawers H 18                      1 deep drawer H 36</p>		L 60	E6541621/2	706	788		
			+15	+20			
			+50	+65			
 <p><b>colonna per forno</b>  <b>1 anta superiore H 96</b>  <b>2 cestoni H 36</b>                      oven column                      1 upper door H 96                      2 deep drawers H 36</p>	L 60	E6541631/2	655	729			
			+15	+20			
			+50	+65			
 <p><b>profilo in acciaio a "L" per rifinire il ripiano del forno e del microonde</b>                      L-shaped steel finishing profile for shelf of oven and microwave</p> 	L 60						
	inox stainless steel	08660100	9	9			
	nero black	08660101	9	9			
	bianco white	08660102	9	9			
 <p><b>kit protezione fianchi per forno</b>                      protection kit sides for oven</p> 	coppia couple	08630095	16	16			

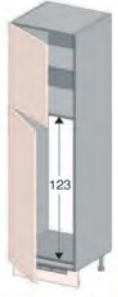
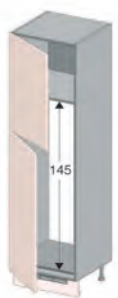
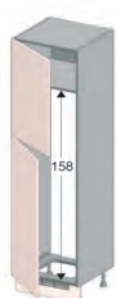
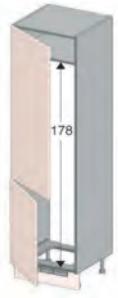
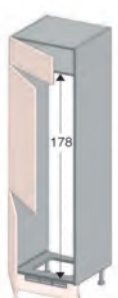

		COD.	FASCIA A K70	FASCIA B K70			
 <p><b>colonna per forno e micro</b>  <b>1 anta superiore H 72</b>  <b>vano micro da H 36,5 a 46,5</b>  <b>cestone H 48</b>                      oven and microwave column                      1 upper door H 72                      microwave compartment H 36,5 to 46,5                      deep drawer H 48</p>	L 60	E6561601/2	575	641			
 <p><b>colonna per forno</b>  <b>1 anta superiore H 72</b>  <b>1 anta H 48 sollevamento verticale</b>  <b>1 cestone H 48</b>                      oven column                      1 upper door H 72                      1 door H 48 vertical opening                      1 deep drawer H 48</p>	L 60	E6564601/2	770	845			
 <p><b>colonna forno sospesa H 156 per lavastoviglie</b>  <b>1 anta H 96</b>                      hanging oven column H 156 for dishwasher                      1 door H 96</p>	L 60	E6577601/2	387	425			
 <p><b>fianco per elettrodomestici a fine composizione</b>                      side panel for appliances placed at the end of the                      composition</p>							
	come anta same as door <b>H 243x59,9x2,2</b>		T94578	329	349		



LE COLONNE NON SONO COMPRENSIVE DI TOP THE COLUMNS UNITS DO NOT INCLUDE THE TOPS		COD.	FASCIA A K70	FASCIA B K70				
 <p><b>colonna H 147 per frigo 215 monoporta</b> column H 147 for single-door fridge 215</p>								
	L 60	E6452151/2	339	389				
 <p><b>colonna H 219 per frigo 215 monoporta</b> <b>1 anta superiore H 72</b> <b>1 anta inferiore H 132</b> column H 219 for 215 single-door fridge 1 upper door H 72 lower door H 132</p>								
	L 60	E6462151/2	481	564				
 <p><b>colonna H 219 per frigo-freezer 230</b> <b>1 anta superiore H 84</b> <b>1 anta inferiore H 120</b> column H 219 for 230 fridge-freezer 1 upper door H 84 1 lower door H 120</p>								
	L 60	E6462311/2	481	564				
 <p><b>colonna H 219 per frigo-freezer 280</b> <b>1 anta superiore H 84</b> <b>1 anta inferiore H 120</b> column H 219 for 280 fridge-freezer 1 upper door H 84 1 lower door H 120</p>								
	L 60	E6462861/2	481	564				
 <p><b>colonna H 219 per frigo-congelatore 315</b> <b>2 ante</b> <b>anta superiore H 132</b> <b>anta inferiore H 72</b> column H 219 for 315 fridge-freezer 2 doors upper door H 132 lower door H 72</p>								
	L 60	E6463151/2	481	564				
 <p><b>colonna H 219 per frigo-congelatore 315</b> <b>3 ante</b> <b>anta superiore H 24</b> <b>anta centrale H 108</b> <b>anta inferiore H 72</b> column H 219 for 315 fridge-freezer 3 doors upper door H 24 central door H 108 lower door H 72</p>								
	L 60	E6463161/2	551	650				

# COLONNE PER FRIGO H 219

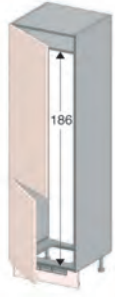
P 59,9

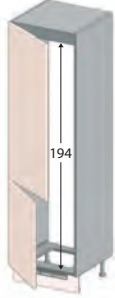
FRIDGE COLUMNS H 219

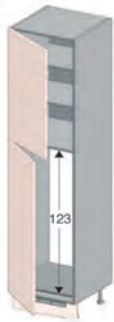
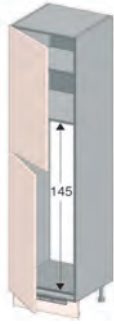
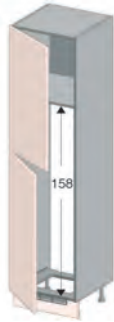

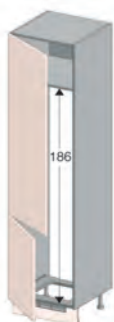

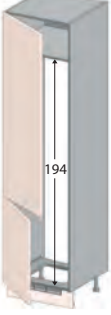
	COD.	FASCIA A K70	FASCIA B K70				
 <p><b>colonna H 219 per frigo-congelatore 330</b>  <b>1 anta superiore H 132</b>  <b>1 anta inferiore H 72</b>                      column H 219 for 330 fridge-freezer                      1 upper door H 132                      1 lower door H 72</p>							
	L 60	E6463301/2	481	564			
 <p><b>colonna H 219 per frigo-freezer 300 monoporta</b>  <b>1 anta H 204 (132+72)</b>                      column H 219 for 300 single-door fridge-freezer                      1 door H 204 (132+72)</p>							
	L 60	E6463001/2	481	564			
 <p><b>colonna H 219 per frigo-congelatore 350</b>  <b>1 anta superiore H 132</b>  <b>1 anta inferiore H 72</b>                      column H 219 for 350 fridge-freezer                      1 upper door H 132                      1 lower door H 72</p>							
	L 60	E6463511/2	481	564			

		COD.	FASCIA A K70	FASCIA B K70			
 <p><b>colonna H 243 per frigo 215 monoporta</b>  <b>1 anta superiore H 96</b>  <b>1 anta inferiore H 132</b>                      column H 243 for 215 single-door fridge                      1 upper door H 96                      1 lower door H 132</p>							
	L 60	E6472151/2	540	637			
 <p><b>colonna H 243 per frigo-freezer 230</b>  <b>1 anta superiore H 108</b>  <b>1 anta inferiore H 120</b>                      column H 243 for 230 fridge-freezer                      1 upper door H 108                      1 lower door H 120</p>							
	L 60	E6472311/2	540	637			
 <p><b>colonna H 243 per frigo-freezer 280</b>  <b>1 anta superiore H 108</b>  <b>1 anta inferiore H 120</b>                      column H 243 for 280 fridge-freezer                      1 upper door H 108                      1 lower door H 120</p>							
	L 60	E6472861/2	540	637			
 <p><b>colonna H 243 per frigo-congelatore 315</b>  <b>2 ante</b>  <b>anta superiore H 156</b>  <b>anta inferiore H 72</b>                      column H 243 for 315 fridge-freezer                      2 doors                      upper door H 156                      lower door H 72</p>							
	L 60	E6473151/2	540	637			
 <p><b>colonna H 243 per frigo-congelatore 315</b>  <b>3 ante</b>  <b>anta superiore H 48</b>  <b>anta centrale H 108</b>  <b>anta inferiore H 72</b>                      column H 243 for 315 fridge-freezer                      3 doors                      upper door H 48                      central door H 108                      lower door H 72</p>							
	L 60	E6473161/2	580	684			
 <p><b>colonna H 243 per frigo-congelatore 330</b>  <b>2 ante</b>  <b>anta superiore H 156</b>  <b>anta inferiore H 72</b>                      column H 243 for 330 fridge-freezer                      2 doors                      upper door H 156                      lower door H 72</p>							
	L 60	E6473301/2	540	637			

	COD.	FASCIA A K70	FASCIA B K70				
 <p><b>colonna H 243 per frigo-congelatore 300 monoporta</b>  <b>1 anta superiore H 48</b>  <b>1 anta inferiore H 180 (108+72)</b>                      column H 243 for 300 single-door fridge-freezer                      1 upper door H 48                      1 lower door H 180 (108+72)</p>	L 60	E6473001/2	540	637			
 <p><b>colonna H 243 per frigo-congelatore 350</b>  <b>1 anta superiore H 156</b>  <b>1 anta inferiore H 72</b>                      column H 243 for 350 fridge-freezer                      1 upper door H 156                      1 lower door H 72</p>	L 60	E6473511/2	540	637			

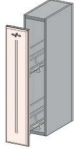

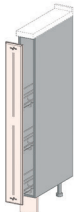
# ELEMENTI CON ANTE FRESATE

ELEMENTS WITH GROOVED DOORS

		COD.	FASCIA A K70	FASCIA B K70			
 <p><b>pensile H 72 prof.33,4 cestello estraibile anta con fresata</b> wall unit H 72 depth 33,4 with pull-out basket unit grooved door</p>							
	L 15	E2010155	162	178			
 <p><b>pensile H 96 prof.33,4 cestello estraibile anta con fresata</b> <b>N.B.: non disponibile per le finiture grigio reale (opz.2454) e bianco artico (opz.2491)</b> wall unit H 96 depth 33,4 with pull-out basket unit grooved door <b>Note: not available for royal grey (opt.2454) and arctic white (opt.2491)</b></p>							
	L 15	E2020155	198	215			
 <p><b>base H 87 prof.59,9 cestello estraibile anta con fresata</b> base unit H 87 depth 59,9 pull-out basket unit grooved door</p>							
	L 15	E4150155	161	177			
 <p><b>colonna H 111 prof.59,9 cestello estraibile anta con fresata</b> <b>N.B.: non disponibile per le finiture grigio reale (opz.2454) e bianco artico (opz.2491)</b> column H 111 depth 59,9 with pull-out basket unit grooved door <b>Note: not available for royal grey (opt.2454) and arctic white (opt.2491)</b></p>							
	L 15	E6045155	320	339			
 <p><b>colonna H 147 prof.59,9 cestello estraibile anta con fresata</b> column H 147 depth 59,9 pull-out basket unit grooved door</p>							
	L 15	E6150155	397	420			
 <p><b>colonna H 219 prof.59,9 cestello estraibile anta con fresata</b> column H 219 depth 59,9 pull-out basket unit grooved door</p>							
	L 15	E6163155	515	555			
 <p><b>colonna H 243 prof.59,9 cestello estraibile anta con fresata</b> <b>N.B.: non disponibile per le finiture grigio reale (opz.2454) e bianco artico (opz.2491)</b> column H 243 depth 59,9 with pull-out basket unit grooved door <b>Note: not available for royal grey (opt.2454) and arctic white (opt.2491)</b></p>							
	L 15	E6173155	531	575			

# ELEMENTI CON FRESATE

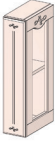
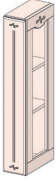
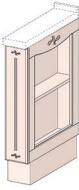
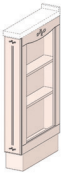
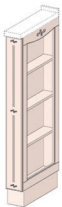

ELEMENTS WITH GROOVES

		COD.	FASCIA A K70	FASCIA B K70			
 <p><b>pensile terminale a giorno H 72 prof.33,4</b> open end wall unit H 72 depth 33,4</p>	L 15	E2581311/2	352	373			
	 <p><b>pensile terminale a giorno H 96 prof.33,4</b> <b>N.B.: non disponibile per le finiture grigio reale (opz.2454) e bianco artico (opz.2491)</b> open end wall unit H 96 depth 33,4 <b>Note: not available for royal grey (opt.2454) and arctic white (opt.2491)</b></p>	L 15	E2582311/2	452	479		
 <p><b>terminale a giorno H 87</b> open end unit H 87</p>							
		<p><b>per base L 15 P 59,9</b> for base unit W 15 D 59,9 <b>per isola/penisola L 15 P 62,3</b> for island/peninsula unit W 15 D 62,3</p>	E4650301/2	445	471		
 <p><b>colonna terminale a giorno H 111 prof.59,9</b> <b>N.B.: non disponibile per le finiture grigio reale (opz.2454) e bianco artico (opz.2491)</b> open end column H 111 depth 59,9 <b>Note: not available for royal grey (opt.2454) and arctic white (opt.2491)</b></p>	L 15	E6365151/2	502	531			
	 <p><b>colonna terminale a giorno H 147 prof.59,9</b> open end column H 147 depth 59,9</p>	L 15	E6365251/2	675	715		
 <p><b>colonna terminale a giorno H 219 prof.59,9</b> open end column H 219 depth 59,9</p>		L 15	E6365351/2	969	1.027		
	 <p><b>colonna terminale a giorno H 243 prof.59,9</b> <b>N.B.: non disponibile per le finiture grigio reale (opz.2454) e bianco artico (opz.2491)</b> open end column H 243 depth 59,9 <b>Note: not available for royal grey (opt.2454) and arctic white (opt.2491)</b></p>	L 15	E6365451/2	1.068	1.132		



# ANTE E FIANCHI DI FINITURA

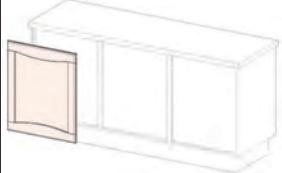

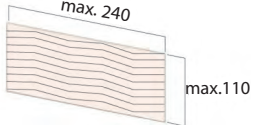
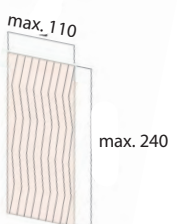

FINISHING SIDES AND PANELS

	COD.	FASCIA A K70	FASCIA B K70				
<p><b>ante di finitura posteriori</b> <b>per basi uso penisola-isola sp.2,2</b> rear finishing doors for base units used as peninsula-island Th.2,2</p> 	<b>BASE</b>						
	BASE UNIT						
	L 30 - 71,7x29,7	1K70430	85	107			
	L 40 - 71,7x39,7	1K70432	91	116			
	L 45 - 71,7x44,7	1K70434	94	119			
	L 60 - 71,7x59,7	1K70436	113	146			
L 65 - 71,7x64,7	1K70438	125	162				
<p><b>maggiorazione per fianchi di struttura</b> <b>impiallacciati come anta (cadauno)</b> surcharge for veneered carcass sides same finish as door (each)</p> 	<b>PENSILE</b>						
	WALL UNIT						
	36x31		+40	+44			
	48x31		+44	+49			
	60x31		+48	+53			
	72x31		+56	+62			
	96x31		+69	+77			
	<b>BASE</b>						
	BASE UNIT						
	36x57,5		+55	+61			
	48x57,5		+65	+72			
	60x57,5		+81	+90			
	72x57,5		+96	+106			
	<b>COLONNA</b>						
	COLUMN						
	132x31		+85	+101			
	204x31		+132	+147			
	228x31		+149	+166			
	96x57,5		+116	+129			
	132x57,5		+148	+164			
204x57,5		+243	+270				
228x57,5		+268	+299				
<p><b>pannello di finitura impiallacciato</b> <b>come anta sp.2,2</b> <b>N.B.: quantità minima fatturabile 0,5 mq</b> finishing panel veneered same as door th.2,2 <b>Note: minimum invoiceable quantity 0,5 m²</b></p> 	<b>venatura orizzontale prezzo al mq</b> horizontal grain prices per m²						
	094524	270	315				
<p><b>pannello di finitura impiallacciato</b> <b>come anta sp.2,2</b> <b>N.B.: quantità minima fatturabile 0,5 mq</b> finishing panel veneered same as door th.2,2 <b>Note: minimum invoiceable quantity 0,5 m²</b></p> 	<b>venatura verticale prezzo al mq</b> vertical grain prices per m²						
	094524V	270	315				

# FIANCHI DI FINITURA SP.5 IMPIALLACCIATI











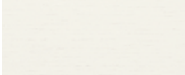

VENEERED FINISHING SIDES TH.5

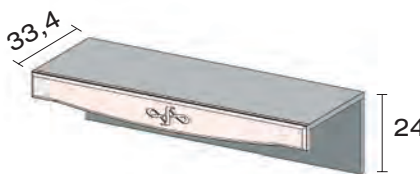
**N.B.: non disponibile per le finiture grigio reale (opz.2454) e bianco artico (opz.2491)**  
 Note: not available for royal grey (opt.2454) and arctic white (opt.2491)

	COD.	FASCIA A K70	FASCIA B K70				
 <p><b>fianco di finitura per pensile con decoro fresato</b> wall unit finishing side with groove decoration</p>							
	H 72x33,4 3K70858	249	262				
	H 96x33,4 3K70859	265	282				
 <p><b>fianco di finitura per base sagomato con decoro fresato</b> base unit finishing side shaped with groove decoration</p>							
	zoccolo H 15 plinth H 15						
	H 87x59,9 3K70866	393	416				
 <p><b>fianco di finitura per isola sagomato 2 lati con decoro fresato</b> island finishing side 2 sides shaped with groove decoration</p>							
	zoccolo H 15 plinth H 15						
	H 87x62,3 3K70867	471	497				
	H 87x93,3 3K70868	523	553				
 <p><b>fianco di finitura per colonna sagomato con decoro fresato</b> column finishing side shaped with groove decoration</p>							
	zoccolo H 15 plinth H 15						
	H 111x59,9 3K70876	393	416				
	H 147x59,9 3K70877	432	455				
	H 219x59,9 3K70878	595	628				
H 243x59,9 3K70879	699	739					

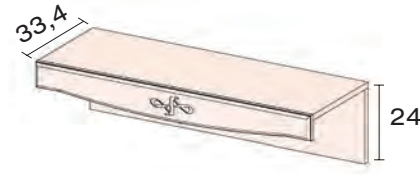

# MENSOLE

SHELVES

	CODICE	FASCIA A	FASCIA B		CODICE	FASCIA A	FASCIA B
<p><b>mensola sp.3,8 in laminato</b> L. max cm 400 laminated shelf th.3,8 max length 400 cm</p>  <p><b>finiture:</b> finishes</p> <div style="display: flex; justify-content: space-around;"> <div style="text-align: center;">   <b>bianco camelia</b> (opz.606) camellia white         </div> <div style="text-align: center;">   <b>visone</b> (opz.948M) mink         </div> </div> <div style="display: flex; justify-content: space-around; margin-top: 10px;"> <div style="text-align: center;">   <b>bianco</b> (opz.001) white         </div> <div style="text-align: center;">   <b>argilla</b> (opz.9690) clay         </div> </div> <p style="text-align: right; margin-top: 20px;"><b>al ml</b> per lm <b>P 31</b></p> <p style="text-align: center;"><b>magg. reggimensola a scomparsa</b> surcharge fully integrated shelf bracket <b>P 61</b></p>					<p><b>mensola soprapensile in laminato con schienale e cornice sagomata</b> above-wall unit laminate shelf with back panel and shaped frame</p>  <p style="text-align: right; margin-top: 20px;"><b>L 60</b> E8630600 <b>L 90</b> E8630900 <b>L 120</b> E8631200</p>		
					<p><b>mensola soprapensile in laminato con cornice sagomata</b> above-wall unit laminate shelf with shaped frame</p>  <p style="text-align: right; margin-top: 20px;"><b>L 60</b> E8650600 <b>L 90</b> E8650900 <b>L 120</b> E8651200</p>		
<p><b>mensola sp.3,8 impiallacciata</b> colore come anta L. max cm 300</p> <p style="color: red;"><b>n.b.: quantità minima fatturabile 0,5 ml</b></p>  <p>veneered shelf th.3,8 colour matching with door max: length 300 cm</p> <p style="color: red;"><b>note: minimum invoiceable quantity 0,5 lm</b></p> <div style="display: flex; justify-content: space-around; margin-top: 20px;"> <div style="text-align: center;">   <b>bianco a poro aperto</b> (opz.2451) white open pore         </div> <div style="text-align: center;">   <b>corda decapè</b> (opz.2452) pickled jute         </div> </div> <div style="display: flex; justify-content: space-around; margin-top: 10px;"> <div style="text-align: center;">   <b>grigio reale</b> (opz.595) royal grey         </div> <div style="text-align: center;">   <b>bianco artico</b> (opz.590) arctic white         </div> </div> <p style="text-align: right; margin-top: 20px;"><b>al ml</b> per lm <b>P 31</b></p> <p style="text-align: center;"><b>magg. reggimensola a scomparsa</b> surcharge fully integrated shelf bracket <b>P 61</b></p>					<p><b>mensola soprapensile impiallacciata con schienale e cornice sagomata</b> above-wall unit veneered shelf with back panel and shaped frame</p>  <p style="text-align: right; margin-top: 20px;"><b>L 60</b> E8730600 <b>L 90</b> E8730900 <b>L 120</b> E8731200</p>		
					<p><b>mensola soprapensile impiallacciata con cornice sagomata</b> above-wall unit veneered shelf with shaped frame</p>  <p style="text-align: right; margin-top: 20px;"><b>L 60</b> E8750600 <b>L 90</b> E8750900 <b>L 120</b> E8751200</p>		
<p><b>mensola soprapensile in laminato P.31 con schienale</b> above-wall unit laminate shelf D 31 with back panel</p>  <p style="text-align: right; margin-top: 20px;"><b>L 45</b> E8620450 <b>L 60</b> E8620600 <b>L 80</b> E8620800 <b>L 90</b> E8620900 <b>L 105</b> E8621050 <b>L 120</b> E8621200 <b>L 135</b> E8621350 <b>L 150</b> E8621500</p>							

# MENSOLE - CORNICI

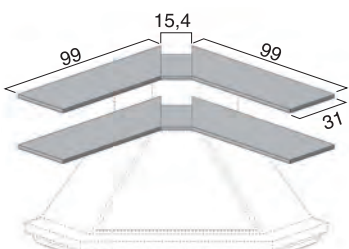
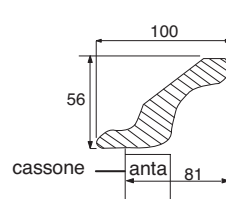
SHELVES - CORNICES

	CODICE	FASCIA A	FASCIA B		CODICE	FASCIA A	FASCIA B	
<p><b>mensole prof.31</b> per cappa caminetto ad angolo shelves D 31 for corner chimney hood</p>  <p><b>Laminato</b> Laminate nr.2 da 99 taglio 45° dx 2x99 cm 45° cut RH nr.2 da 99 taglio 45° sx 2x99 cm 45° cut LH nr.2 da 15,4 taglio dritto 2x15,4 cm straight cut</p> <p><b>Impiallacciata</b> Veneered nr.2 da 99 taglio 45° dx 2x99 cm 45° cut RH nr.2 da 99 taglio 45° sx 2x99 cm 45° cut LH nr.2 da 15,4 taglio dritto 2x15,4 cm straight cut</p>	091523	124	124	<p><b>cornice cappello</b> (per motivi tecnici le cornici in angoli fuori squadra non si possono inviare tagliate) top cornice (for technical reasons, cornices for out-of-plumb corners cannot be shipped already cut)</p>   <p>al ml per lm</p>	093010	58	67	
	091523	124	124					
	091523	20	20					
	091723	156	171					
	091723	156	171					
	091723	25	27					

## SCHIENALE DOGATO IMPIALLACCIATO COLORE COME ANTA

VENEERED BACK PANEL WITH STRIPES, SAME COLOUR AS DOOR

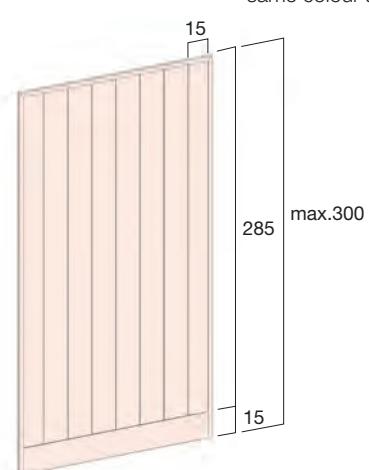
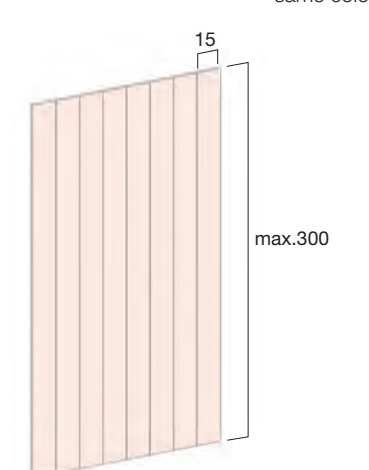

**N.B.: quantità minima fatturabile 1 mq**  
Note: minimum invoiceable quantity 1 m<sup>2</sup>

	CODICE	€		CODICE	€
<p><b>Schienale dogato completo</b> di cornice e zoccolo sp. 20 mm colore come anta striped back panel complete with cornice and plinth th. 20 mm same colour as door</p>  <p>al mq per m<sup>2</sup></p>	094327	358	<p><b>Schienale dogato senza cornice</b> e zoccolo sp. 18 mm. colore come anta striped back panel without cornice and plinth th. 18 mm same colour as door</p>  <p>al mq per m<sup>2</sup></p>	094325	261

# CREDENZA





SIDE BOARD UNIT



	CODICE	FASCIA A	FASCIA B		CODICE	FASCIA A	FASCIA B
<p><b>Credenza da 180</b> W 180 side board unit</p> <p><b>L 193,2 H 216,6 P 51,5</b> W 193,2 H 216,6 D 51,5</p>				<p><b>Credenza da 135</b> W 135 side board unit</p> <p><b>L 148,2 H 216,6 P 51,5</b> W 148,2 H 216,6 D 51,5</p>			
		3.835	4.141			3.052	3.299
<p><b>Credenza da 180</b> W 180 side board unit</p> <p><b>L 193,2 H 216,6 P 51,5</b> W 193,2 H 216,6 D 51,5</p>				<p><b>Madia da 180</b> W 180 pastry board unit</p> <p><b>L 193,2 H 95 P 51,5</b> W 193,2 H 95 D 51,5</p>			
		3.865	4.144			1.963	2.100

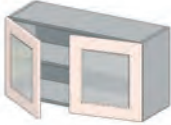

# ELEMENTI PER MADIA

ELEMENTS FOR PASTRY BOARD UNIT

	COD.	FASCIA A K70	FASCIA B K70				
 <p><b>1 anta vetro H 48</b> 1 glass door H 48</p>	L 45	E1040451/2	192	229			
	L 60	E1040601/2	204	240			
			+44	+49			
<b>mag.fianco struttura come anta</b> surcharge for side panels same as door							
 <p><b>2 ante vetro H 48</b> 2 glass doors H 48</p>	L 90	E1040900	343	417			
			+44	+49			
	<b>mag.fianco struttura come anta</b> surcharge for side panels same as door						
 <p><b>portacoltelli impiallacciato per madia</b> <b>colore come anta</b> <b>H 72 P 33,4</b> veneered knives holder for pastry board unit colour same as door H 72 D 33,4</p>	L 30	08602830	284	284			
	<b>portabottiglie impiallacciato per madia</b> <b>1 cassetto</b> <b>colore come anta</b> <b>H 72 P 33,4</b> veneered bottle holder for pastry board unit 1 drawer colour same as door H 72 D 33,4						
	L 45	08602835	284	284			
	<b>portamattarello impiallacciato per madia</b> <b>2 ripiani</b> <b>colore come anta</b> <b>H 72 P 33,4</b> veneered rolling pin holder for pastry board unit 2 shelves colour same as door H 72 D 33,4						
	L 60	08602842	284	284			

# ELEMENTI PER MADIA

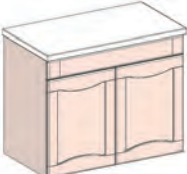
ELEMENTS FOR PASTRY BOARD UNIT

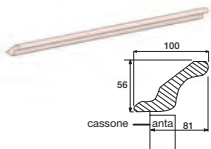
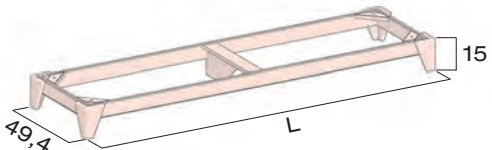
LE BASI NON SONO COMPRENSIVE DI TOP THE BASE UNITS DO NOT INCLUDE THE TOPS		COD.	FASCIA A K70	FASCIA B K70					
 <p><b>base H 72 per madia</b> <b>1 cassetto H 12</b> <b>1 anta H 60</b> base unit H 72 for pastry board unit 1 drawer H 12 1 door H 60</p>	<b>L 45 P 48</b>	E4022481/2	265	299					
	<b>L 60 P 48</b>	E4022681/2	292	331					
	<b>mag.fianco struttura come anta cad.</b> surcharge for side panels same as door each			+96	+106				
 <p><b>base H 72 per madia</b> <b>1 cassetto H 12</b> <b>2 anta H 60</b> base unit H 72 for pastry board unit 1 drawer H 12 2 door H 60</p>	<b>L 90 P 48</b>	E4022910	386	438					
	<b>mag.fianco struttura come anta cad.</b> surcharge for side panels same as door each			+96	+106				
 <p><b>top impiallacciato come anta</b> <b>con bordo massello</b> <b>L max 300</b> veneered worktop same as door with solid wood edge max.length 300</p>	<b>P 51,5 sp.4 al ml</b> D 51,5 th.4 per lm	TIA406	251	251					
 <p><b>alzatina per top</b> <b>L max 300</b> backsplash for worktop max.length 300</p>	<b>H 4 sp.2 al ml</b> H 4 th.2 per lm	TIAA04	51	51					
 <p><b>cornice cappello</b> top cornice</p>	<b>al ml</b> per lm	093010	58	67					
<p><b>basamento per madia</b> <b>H 15 P 49,4</b> basement for pastry board unit H 15 D 49,4</p> 	<b>al ml</b> per lm	T93115	195	195					

# ISOLA IN LEGNO

WOOD ISLAND



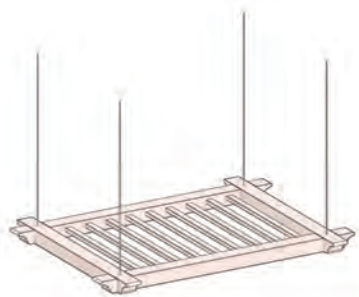

	COD.	€				
<p><b>isola in legno con 3 cassetti e ripiano grigliato</b>  <b>colore come anta</b>                      wood island with 3 drawers and wire shelf                      same colour as door</p>  <p style="text-align: right;"><b>L 180 H 89 P 90</b></p>	E4951100	1.340				
<p><b>elemento sopra isola in legno</b>  <b>colore come anta</b>                      wood over island unit                      same colour as door</p>  <p style="text-align: right;"><b>L 120 H 6 P 90</b></p>	08605960	736				



# PIATTAIA

PLATE RACK

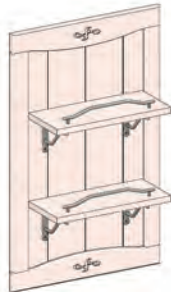

		COD.	FASCIA A K 70	FASCIA B K 70
 <p><b>Piattaia H 96 P 21,5 colore come anta con reggimensole e ringhierine argento anticato</b> plate rack H 96 D 21,5 same colour as door with antique silver shelves bracket and wire rings</p>	L 60	08602822	702	862
 <p><b>Piattaia H 96 P 21,5 colore come anta</b> plate rack H 96 D 21,5 same colour as door</p>	L 90	08602823	886	955

# SOTTOPENSILI PORTABICCHIERI

UNDERMOUNT WALL UNIT WITH GLASSES HOLDER

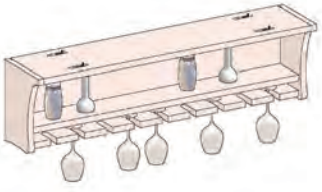

	COD.	FASCIA A K 70	FASCIA B K 70	
 <p><b>Sottopensile portabicchieri</b>  <b>H 24 P 19 colore come anta</b>                      undermount wall unit H 24 D 19                      with glasses holder, same colour as door</p>	L 60	08602802	388	427
	L 90	08602803	492	541

# LIVING

Aurea spazia nell'area living offrendo infinite soluzioni d'arredo con vani a giorno, mensole, ripiani e contenitori che ne fanno un sistema completo in grado di trasformare lo spazio in ambienti che possono vivere indipendentemente o presentarsi senza soluzione di continuità con l'ambiente cucina.







I living proposti da Aurea anticipano e si adattano alle esigenze contemporanee unendo l'accuratezza del lavoro manuale dei suoi intarsi all'innovazione della produzione industriale, creando delle soluzioni uniche e personali.

Aurea model ranges in the living area providing endless furnishing solutions with open units, shelves and cabinets that makes it a complete system able to transform the space into environments that can live independently or show up seamlessly with the kitchen environment.

The living items proposed by Aurea anticipate and adapt to contemporary needs by combining the accuracy of the manual work of its inlays to innovation of the industrial production, creating unique and personal solutions.









**Per la modulistica completa dei pensili consultare la sezione "Pensili"**  
 For complete modularity of wall units see "Wall units" section

	COD.	FASCIA A K70	FASCIA B K70					
 <p><b>pensile H 36</b>                      apertura a vasistas con push-pull (opz.996)                      wall unit H 36                      flap door with push-pull opening (opt.996)</p>	L 60	E2106600	185	204				
	L 90	E2106900	278	302				
			+15	+20				
			+50	+65				
		<p><b>mag.anta con intarsio</b>                      surcharge for door with inlaid</p> <p><b>mag.anta con decoro metallico</b>                      surcharge for door with metallic decor</p>						
 <p><b>pensile H 48</b>                      apertura a vasistas con push-pull (opz.996)                      wall unit H 48                      flap door with push-pull opening (opt.996)</p>	L 60	E2123600	278	300				
	L 90	E2123900	321	353				
 <p><b>pensile H 120</b>                      2 ante H 60                      wall unit H 120                      2 doors H 60</p>	L 60	E2140601/2	307	359				
 <p><b>pensile H 132</b>                      1 anta vetro con maniglia sopra                      wall unit H 132                      1 glass door with upper handle</p>	L 45	E1026451/2	363	424				
	L 60	E1026601/2	421	496				
 <p><b>mensola in appoggio per pensile</b>                      finitura come anta L.max 300                      support shelf for wall unit                      same finish as door max.lenght 300</p>								
		impiallacciata veneered P 33,4 sp.2,2 al ml D 33,4 th.2,2 per lm	TIL245	100	115			
 <p><b>maggiorazione per fianchi di struttura</b>                      come anta (cadauno)                      surcharge for carcass sides same finish as door (each)</p>								
		<b>PENSILE</b> WALL UNIT						
		36x31		+40	+44			
		48x31		+44	+49			
		120x31		+85	+101			
	132x31		+85	+101				

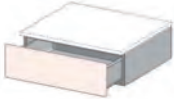
# BASI LIVING in appoggio sul basamento

H 18 - 24 - 36 - 48 P 50,4

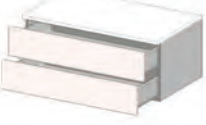



LIVING AREA BASE UNITS lay on basament





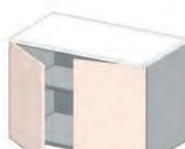

LE BASI NON SONO COMPRENSIVE DI TOP THE BASE UNITS DO NOT INCLUDE THE TOPS		COD.	FASCIA A K70	FASCIA B K70					
 <p><b>base H 18</b> <b>1 cassetto</b> base unit H 18 1 drawer</p>	L 45	EBL03450	139	153					
	L 60	EBL03600	159	172					
	L 90	EBL03900	199	214					
 <p><b>base H 36</b> <b>1 anta</b> base unit H 36 1 door</p>	L 45	EBL21451/2	151	169					
	L 60	EBL21601/2	168	186					
			<b>mag.anta con intarsio</b> surcharge for door with inlaid	+15	+20				
			<b>mag.anta con decoro metallico</b> surcharge for door with metallic decor	+50	+65				
 <p><b>base H 36</b> <b>2 ante</b> base unit H 36 2 doors</p>	L 90	EBL21900	256	291					
	L 120	EBL22200	291	329					
			<b>mag.ante con intarsio</b> surcharge for doors with inlaid	+30	+40				
			<b>mag.ante con decoro metallico</b> surcharge for doors with metallic decor	+100	+130				
 <p><b>base H 36</b> <b>1 cestone</b> base unit H 36 1 deep drawer</p>	L 45	EBL25450	197	214					
	L 60	EBL25600	215	234					
	L 90	EBL25900	253	278					
			<b>mag.cestone con intarsio</b> surcharge for deep drawer with inlaid	+15	+20				
		<b>mag.cestone con decoro metallico</b> surcharge for deep drawer with metallic decor	+50	+65					
 <p><b>base H 36</b> <b>2 cassetti H 18</b> base unit H 36 2 drawers H 18</p>	L 45	EBL23450	243	272					
	L 60	EBL23600	269	296					
	L 90	EBL23900	330	360					
 <p><b>base H 48</b> <b>1 anta</b> base unit H 48 1 door</p>	L 45	EBL31451/2	176	196					
	L 60	EBL31601/2	194	216					



# BASI LIVING in appoggio sul basamento

H 48 - 60 P 50,4



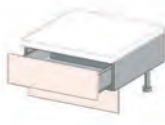

LIVING AREA BASE UNITS lay on basament

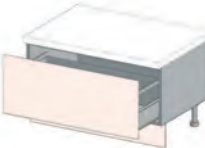
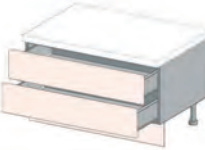
<b>LE BASI NON SONO COMPRENSIVE DI TOP</b> THE BASE UNITS DO NOT INCLUDE THE TOPS		COD.	FASCIA A K70	FASCIA B K70					
 <p><b>base H 48</b> <b>2 ante</b> base unit H 48 2 doors</p>	L 90	EBL31900	287	325					
	L 120	EBL32200	329	372					
 <p><b>base H 48</b> <b>1 cestone</b> base unit H 48 1 deep drawer</p>	L 45	EBL35450	204	224					
	L 60	EBL35600	224	246					
	L 90	EBL35900	275	307					
 <p><b>base H 60</b> <b>1 anta</b> base unit H 60 1 door</p>	L 45	EBL41451/2	179	199					
	L 60	EBL41601/2	205	231					
 <p><b>base H 60</b> <b>2 ante</b> base unit H 60 2 doors</p>	L 90	EBL41900	292	333					
	<p><b>top living</b> <b>finitura come anta L.max 300</b> worktop living same finish as door max.lenght 300</p> 								
		<p><b>impiallacciato</b> veneered <b>P 50,4 sp.2,4 al ml</b> D 50,4 th.2,4 per lm</p>	TIL226	150	175				
 <p><b>maggiorazione per fianchi di struttura</b> <b>come anta (cadauno)</b> surcharge for carcass sides same finish as door (each)</p>	<b>BASI</b>								
	BASE UNITS								
	18x48			+55	+61				
	24x48			+55	+61				
	36x48			+55	+61				
	48x48			+65	+72				
60x48			+81	+90					

LE BASI NON SONO COMPRENSIVE DI TOP THE BASE UNITS DO NOT INCLUDE THE TOPS		COD.	FASCIA A K70	FASCIA B K70				
 <p><b>base H 36 1 anta</b> base unit H 36 1 door</p>	L 45	EBL71451/2	164	181				
	L 60	EBL71601/2	180	199				
			+15	+20				
			+50	+65				
 <p><b>base H 48 1 anta</b> base unit H 48 1 door</p>	L 45	EBL81451/2	189	208				
	L 60	EBL81601/2	207	229				
 <p><b>base H 36 2 ante</b> base unit H 36 2 doors</p>	L 90	EBL71900	257	292				
	L 120	EBL72200	293	330				
			+30	+40				
			+100	+130				
 <p><b>base H 48 2 ante</b> base unit H 48 2 doors</p>	L 90	EBL81900	294	333				
	L 120	EBL82200	338	382				
 <p><b>base H 36 1 cestone</b> base H 36 1 deep drawer</p>	L 45	EBL75450	215	232				
	L 60	EBL75600	234	251				
	L 90	EBL75900	271	295				
			+15	+20				
			+50	+65				
 <p><b>base H 48 1 cestone</b> base unit H 48 1 deep drawer</p>	L 45	EBL85450	222	241				
	L 60	EBL85600	242	263				
	L 90	EBL85900	292	324				

LE BASI NON SONO COMPRENSIVE DI TOP THE BASE UNITS DO NOT INCLUDE THE TOPS		COD.	FASCIA A K70	FASCIA B K70					
 <p><b>base H 33</b> <b>1 cassetto H 18</b> base unit H 33 1 drawer H 18</p>	L 45	E4023450	152	167					
	L 60	E4023600	171	185					
	L 90	E4023900	218	233					
 <p><b>base H 51</b> <b>1 anta H 36</b> base unit H 51 1 door H 36</p>	L 45	E4026451/2	164	182					
	L 60	E4026601/2	180	199					
				+15	+20				
				+50	+65				
 <p><b>base H 51</b> <b>2 ante H 36</b> base unit H 51 2 doors H 36</p>	L 90	E4026900	276	311					
				+30	+40				
				+100	+130				
 <p><b>base H 51</b> <b>1 cestone H 36</b> base unit H 51 1 deep drawer H 36</p>	L 45	E4204450	202	220					
	L 60	E4204600	217	236					
	L 90	E4204900	266	291					
				+15	+20				
				+50	+65				
 <p><b>base H 51</b> <b>2 cassetti H 18</b> base unit H 51 2 drawers H 18</p>	L 45	E4204460	246	274					
	L 60	E4204610	268	294					
	L 90	E4204910	333	363					



LE BASI NON SONO COMPRENSIVE DI TOP THE BASE UNITS DO NOT INCLUDE THE TOPS		COD.	FASCIA A K70	FASCIA B K70				
 <p><b>base H 63 1 anta H 48</b> base unit H 63 1 door H 48</p>	L 45	E4028451/2	174	194				
	L 60	E4028601/2	189	210				
 <p><b>base H 63 2 ante H 48</b> base unit H 63 2 doors H 48</p>	L 90	E4028900	295	333				
	L 120	E4029200	331	374				
 <p><b>base H 63 1 cestone H 48</b> base unit H 63 1 deep drawer H 48</p>	L 45	E4205450	210	229				
	L 60	E4205600	226	248				
	L 90	E4205900	288	320				
 <p><b>top living finitura come anta L.max 300</b> worktop living same finish as door max.lenght 300</p>								
		impiallacciato veneered P 59,9 sp.2,4 al ml D 59,9 th.2,4 per lm	TIL227	161	190			
 <p><b>maggiorazione per fianchi di struttura come anta (cadauno)</b> surcharge for carcass sides same finish as door (each)</p>								
		<b>BASI BASE UNITS</b>						
		18x57,5		+55	+61			
		24x57,5		+55	+61			
		36x57,5		+55	+61			
	48x57,5		+65	+72				



# LIVING K70-2



ANTA  
door



CORDA DECAPÈ  
pickled jute

STRUTTURA  
carcass



CORDA DECAPÈ  
pickled jute

# LIVING K70-2

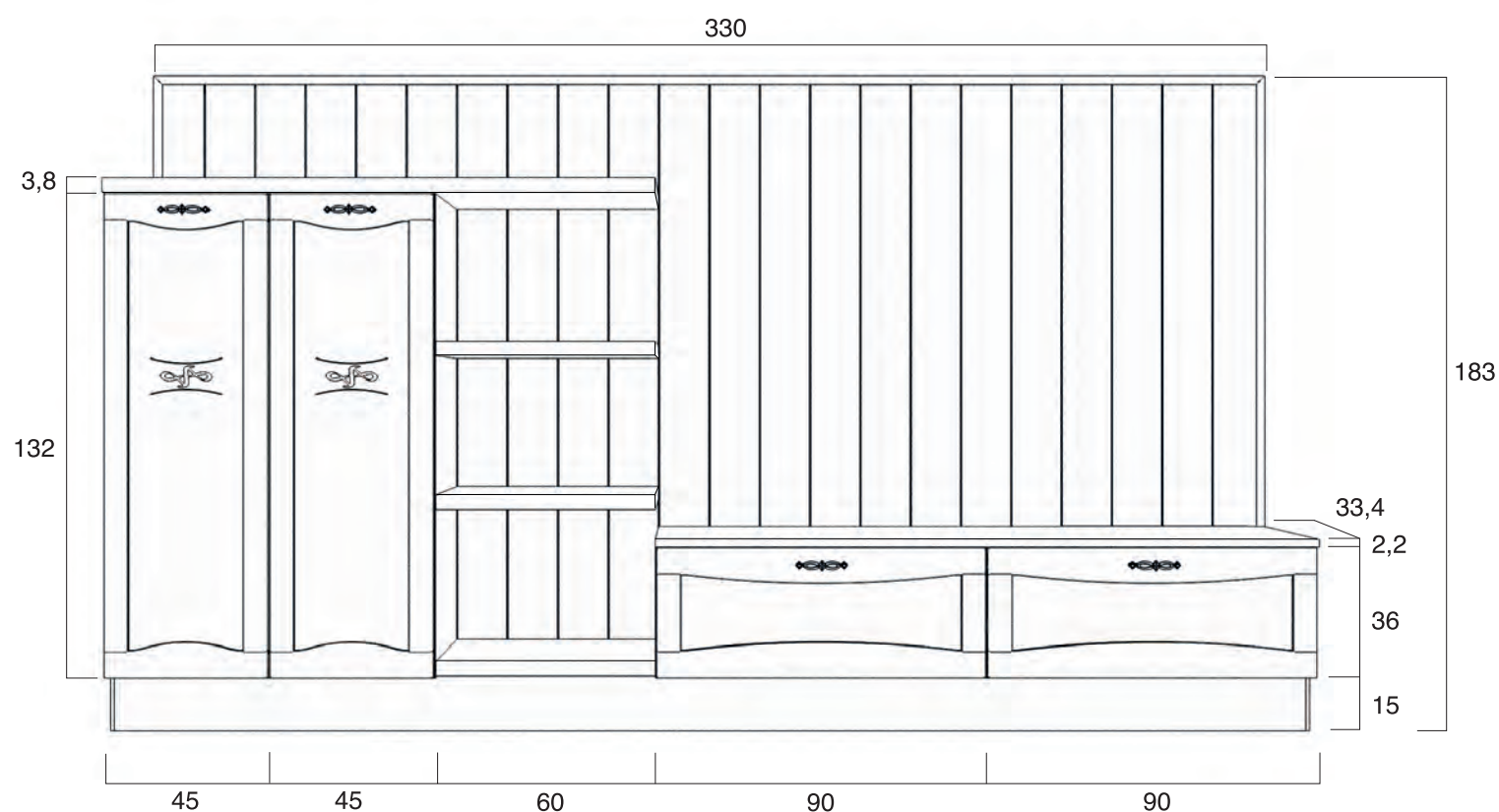

NR. ELEMENTI	DESCRIZIONE	CODICE	fascia A cad.	fascia B cad.
1	Colonna L 90 H 147 P 33,4 anta vetro, fianchi come anta	E6180910	799	953
2	Base L 90 H 51 P 33,4 apertura vasistas, fianco come anta	E4027900	363	387
1	Top L 180 H 2,2 P 33,4 impiallacciato come anta	al ml TIL225	100	115
1	Mensola L 150 H 3,8 P 33,4 impiallacciata come anta	al ml 0917237	157	172
3	Mensola L 60 H 3,8 P 31 impiallacciata come anta	al ml 091723	157	172
senza schienale <b>TOTALE</b>			<b>2.223</b>	<b>2.502</b>
1	Schienale dogato con cornice L 330 H 183 sp.2 come anta	al mq 094327	358	358
con schienale <b>TOTALE</b>			<b>4.385</b>	<b>4.664</b>
No. of ELEMENTS	DESCRIPTION	CODE	band A each	band B each
1	Column W 90 H 147 D 33,4 glass door, sides same as door	E6180910	799	953
2	Base unit W 90 H 51 D 33,4 flap door opening, side same as door	E4027900	363	387
1	Veneered worktop W 180 H 2,2 D 33,4 same colour as door	per lm TIL225	100	115
1	Veneered shelf W 150 H 3,8 D 33,4 same colour as door	per lm 0917237	157	172
3	Veneered shelf W 60 H 3,8 D 31 same colour as door	per lm 091723	157	172
with out back panel <b>TOTAL</b>			<b>2.223</b>	<b>2.502</b>
1	Striped back panel with cornice W 330 H 183 Th. 2 same as door	per mq 094327	358	358
with back panel <b>TOTAL</b>			<b>4.385</b>	<b>4.664</b>

# LIVING K70-3



ANTA  
door



STRUTTURA  
carcass



# LIVING K70-3

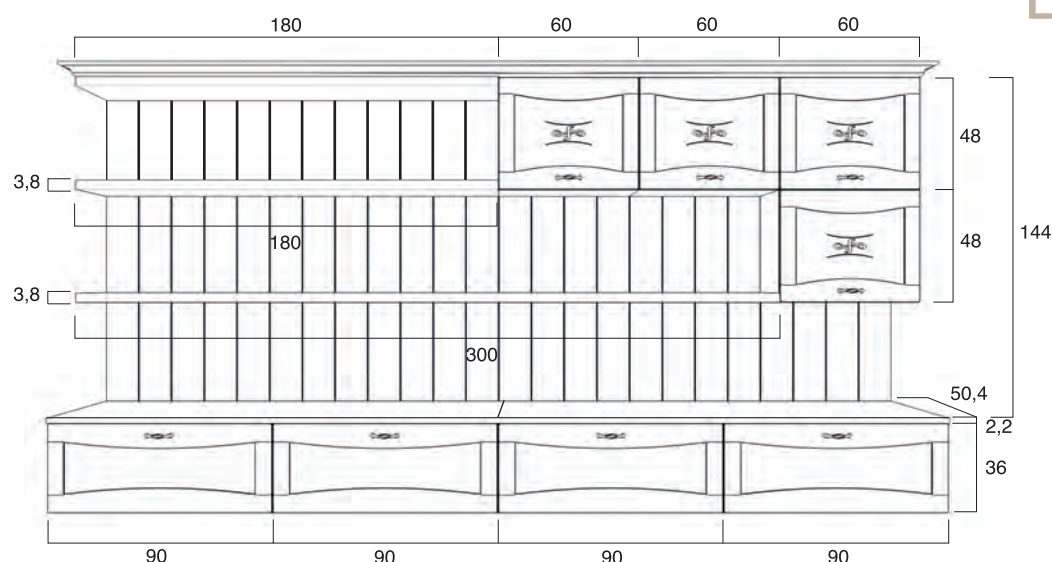

NR. ELEMENTI	DESCRIZIONE	CODICE	fascia A cad.	fascia B cad.
2	Pensile L 60 H 48 P 33,4 anta vetro, fianco come anta	E1040601/2	248	289
1	Pensile L 60 H 48 P 33,4 anta vetro	E1040601/2	204	240
1	Pensile L 60 H 48 P 33,4 anta vetro, fianchi come anta	E1040601/2	292	338
2	Base living sospesa L 90 H 36 P 50,4, cestone fianco come anta	EBL75900	326	356
2	Base living sospesa L 90 H 36 P 50,4 cestone	EBL75900	271	295
1	Top L 180+180 H 2,2 P 50,4 impiallacciato come anta	al ml TIL226	150	175
2	Mensola L 180 H 3,8 P 31 impiallacciata come anta	al ml 091723	157	172
1	Mensola L 300 H 3,8 P 31 impiallacciata come anta	al ml 091723	157	172
1	Cornice cappello L 451,2	al ml 093010	58	67
2	Asta appendipensili ml 2	08610501	9	9
senza schienale <b>TOTALE</b>			<b>4.033</b>	<b>4.535</b>
1	Schienale dogato senza cornice L 360 H 144 sp.1,8 come anta	al mq 094325	261	261
con schienale <b>TOTALE</b>			<b>5.386</b>	<b>5.888</b>
No. of ELEMENTS	DESCRIPTION	CODE	band A each	band B each
2	Wall unit W 60 H 48 D 33,4 glass door, side same as door	E1040601/2	248	289
1	Wall unit W 60 H 48 D 33,4 glass door	E1040601/2	204	240
1	Wall unit W 60 H 48 D 33,4 glass door, sides same as door	E1040601/2	292	338
2	Hanging living base unit W 90 H 36 D 50,4 deep drawer, side same as door	EBL75900	326	356
2	Hanging living base unit W 90 H 36 D 50,4 deep drawer	EBL75900	271	295
1	Veneered worktop W 180+180 H 2,2 D 50,4 same colour as door	per lm TIL226	150	175
2	Veneered shelf W 180 H 3,8 D 31 same colour as door	per lm 091723	157	172
1	Veneered shelf W 300 H 3,8 D 31 same colour as door	per lm 091723	157	172
1	Top cornice W 451,2	per lm 093010	58	67
2	Wall unit fixing strip lm 2	08610501	9	9
with out back panel <b>TOTAL</b>			<b>4.033</b>	<b>4.535</b>
1	Striped back panel without cornice W 360 H 144 Th. 1,8 same colour as door	per mq 094325	261	261
with back panel <b>TOTAL</b>			<b>5.386</b>	<b>5.888</b>

# LIVING K70-4



ANTA  
door

LACCATO BIANCO  
A PORO APERTO  
white lacquered open pore

STRUTTURA  
carcass

BIANCO CAMELIA  
camellia white





## COMPOSIZIONE BASSA L 255

LOW COMPOSITION W 255



## COMPOSIZIONE BASSA L 300

LOW COMPOSITION W 300



## COMPOSIZIONE BASSA L 255

LOW COMPOSITION W 255

(IVA e contributo RAEE esclusi)

(VAT and WEEE fee excluded)

### COMPONENTI COMPONENTS

#### Colonna 60 H 219 frigo-freezer 230 classe A+

60 cm column H 219 fridge-freezer 230 class "A+"

#### Base 45 2 cassetti e cestone

45 cm base unit with 2 drawers and deep drawer

#### Base 60 forno statico nero con ventilazione tangenziale di raffreddamento

black static oven with orbital cooling ventilation 60 base unit

#### Piano cottura 60 4 gas inox con valvola di sicurezza

60 cm stainless steel hob with 4 gas burners with safety valve

#### Sottolavello 90

90 cm sink unit

#### Lavello ad incasso 86 x 50 1 vasca inox prelucidato

86x50 cm built-in sink with 1 stainless steel bowl

#### Pensile vetro 45 H 72

45 cm glass wall unit H 72

#### Cappa 60 aspirante estraibile H 63 1 motore

60 cm hood slide-out ducting H 63 1 motor

#### Scolapiatti 90 H 72

90 cm plate rack H 72

#### Top 195 P 61 in laminato H 4

195 cm laminate worktop D 61 H 4

#### Cornice cappello ml 3,71

3,71 lm top cornice

#### Asta appendipensili ml 2

2 lm wall unit fixing strip

(Elettrodomestici Indesit )  
(Indesit appliances)

### AUREA

#### Fascia A

€ 3.619

Band A

#### Fascia B

€ 3.957

Band B

Maggiorazione per forno statico inox

+ € 63

surcharges for stainless steel static oven

## COMPOSIZIONE BASSA L 300

LOW COMPOSITION W 300

(IVA e contributo RAEE esclusi)

(VAT and WEEE fee excluded)

### COMPONENTI COMPONENTS

#### Colonna 60 H 219 frigo-freezer 230 classe A+

60 cm column H 219 fridge-freezer 230 class "A+"

#### Base 60 2 cassetti e cestone

60 cm base unit with 2 drawers and deep drawer

#### Base 60 forno statico nero con ventilazione tangenziale di raffreddamento

black static oven with orbital cooling ventilation 60 base unit

#### Piano cottura 60 4 gas inox con valvola di sicurezza

60 cm stainless steel hob with 4 gas burners with safety valve

#### Base 60

60 cm base unit

#### Sottolavello 60

60 cm sink unit

#### Lavello ad incasso 86 x 50 1 vasca inox prelucidato

86x50 cm built-in sink with 1 stainless steel bowl

#### Pensile 60 H 72

60 cm wall unit H 72

#### Cappa 60 aspirante estraibile H 63 1 motore

60 cm hood slide-out ducting H 63 1 motor

#### Pensile 60 H 72

60 cm wall unit H 72

#### Scolapiatti 60 H 72

60 cm plate rack H 72

#### Top 240 P 61 in laminato H 4

240 cm laminate worktop D 61 H 4

#### Cornice cappello ml 4,16

4,16 lm top cornice

#### Asta appendipensili ml 4

4 lm wall unit fixing strip

(Elettrodomestici Indesit )  
(Indesit appliances)

### AUREA

#### Fascia A

€ 3.882

Band A

#### Fascia B

€ 4.243

Band B

Maggiorazione per forno statico inox

+ € 63

surcharges for stainless steel static oven

## COMPOSIZIONE ALTA L 300

HIGH COMPOSITION W 300



## COMPOSIZIONE BASSA L 360

LOW COMPOSITION W 360



## COMPOSIZIONE ALTA L 300

HIGH COMPOSITION W 300

(IVA e contributo RAEE esclusi)

(VAT and WEEE fee excluded)

### COMPONENTI COMPONENTS

#### Colonna 60 H 243 frigo-freezer 230 classe A+

60 cm column H 243 fridge-freezer 230 class "A+"

#### Base 60 2 cassetti e cestone

60 cm base unit with 2 drawers and deep drawer

#### Base 60 forno statico nero con ventilazione tangenziale di raffreddamento

black static oven with orbital cooling ventilation 60 base unit

#### Piano cottura 60 4 gas inox con valvola di sicurezza

60 cm stainless steel hob with 4 gas burners with safety valve

#### Base 60

60 cm base unit

#### Sottolavello 60

60 cm sink unit

#### Lavello ad incasso 86 x 50 1 vasca inox prelucidato

86x50 cm built-in sink with 1 stainless steel bowl

#### Pensile 60 H 72

60 cm wall unit H 72

#### Cappa 60 aspirante estraibile H 63 1 motore

60 cm hood slide-out ducting H 63 1 motor

#### Pensile 60 H 96

60 cm wall unit H 96

#### Scolapiatti 60 H 96

60 cm plate rack H 96

#### Top 240 P 61 in laminato H 4

240 cm laminate worktop D 61 H 4

#### Mensola 120 P 31 sp. 3,8

120 cm shelf D 31 sp. 3,8

#### Cornice cappello ml 4,16

4,16 lm top cornice

#### Asta appendipensili ml 4

4 lm wall unit fixing strip

**(Elettrodomestici Indesit )**

(Indesit appliances)

### AUREA

#### Fascia A

Band A

**€ 4.102**

#### Fascia B

Band B

**€ 4.493**

**Maggiorazione per forno statico inox**

surcharges for stainless steel static oven

**+ € 63**

## COMPOSIZIONE BASSA L 360

LOW COMPOSITION W 360

(IVA e contributo RAEE esclusi)

(VAT and WEEE fee excluded)

### COMPONENTI COMPONENTS

#### Colonna 60 H 219 frigo-freezer 230 classe A+

60 cm column H 219 fridge-freezer 230 class "A+"

#### Colonna 60 H 111 con cestone, forno statico nero con ventilazione tangenziale di raffreddamento

60 column H.111 with deep drawer configured for black static oven with orbital cooling ventilation

#### Base 90 2 cassetti + cestone predisposto P.C.

90 cm base unit with 2 drawers + deep drawer configured for hob

#### Piano cottura 60 4 gas inox con valvola di sicurezza

60 cm stainless steel hob with 4 gas burners with safety valve

#### Base 60

60 cm base unit

#### Sottolavello 90

90 cm sink unit

#### Lavello ad incasso 86 x 50 1 vasca inox prelucidato

86x50 cm built-in sink with 1 stainless steel bowl

#### Pensile 60 H 72

60 cm wall unit H 72

#### Cappa 90 caminetto tipo "E"

90 chimney hood type "E"

#### Pensile 60 H 72

60 cm wall unit H 72

#### Scolapiatti 90 H 72

90 cm plate rack H 72

#### Top 240 P 61 in laminato H 4

240 cm laminate worktop D 61 H 4

#### Top 60 P 61 in laminato H 4

60 cm laminate worktop D 61 H 4

#### Mensola 90 P 31 SP 3,8

90 cm shelf D 31 SP 3,8

#### Cornice cappello ml 4,76

4,76 lm top cornice

#### Asta appendipensili ml 4

4 lm wall unit fixing strip

**(Elettrodomestici Indesit )**

(Indesit appliances)

### AUREA

#### Fascia A

Band A

**€ 4.745**

#### Fascia B

Band B

**€ 5.154**

**Maggiorazione per forno statico inox**

surcharges for stainless steel static oven

**+ € 63**