



Burlington®

burlingtonbathrooms.com



January 2023



Part of the  
**Bathroom Brands Group**  
burlingtonbathrooms.com

Lake View House  
Rennie Drive, Dartford  
Kent, DA1 5FU

January 2023

*Burlington*®

# BATHROOMS AND BURLINGTON

Burlington enables homeowners to create bathrooms with the classic forms and finishes from the past but made to modern quality and performance standards.

Early bathrooms were fairly rudimentary affairs, with basins and toilets made from earthenware, baths in copper, tin or cast iron, and taps just simple brass castings. Then in the late Victorian period, improved plumbing and higher quality materials became available. During the Edwardian era, fitted indoor bathrooms began to appear in homes across the land, although it would be another 20 years or so before they became the rule, rather than the exception.

At the turn of the 20th Century, bathroom product design was still in its infancy, and form was still subservient to function. Shapes were square and geometric, with deep upstands on washbasins and large feet on pedestals. More rounded, opulent designs began to appear in the years immediately before the First World War, reflecting the art and architecture of that carefree, innocent time now known as la belle époque.



Burlington's designs have enabled homeowners to create bathrooms with the authentic outlines, forms and finishes of this pivotal period in history. The Victorian and Edwardian models faithfully capture the original designs in all their robust, timeless, seemingly everlasting glory. The Burlington Classic basin, for example, is a perfect reproduction of the 'Cliffe Vale' washbasin, originally produced in 1896. The Arcade collection recreates the more elegant, sophisticated designs that emerged during those peaceful, prosperous pre-First World War years, whilst the Riviera Collection offers precise, geometric forms and subtle linear detailing perfectly capturing the classic 1920s style.

In an age of minimalism and stark, functional spaces, Burlington offers a sanctuary for those who seek the comfort, familiarity and reassurance of more traditional styling. It's a great choice for renovation and replacement projects, and increasingly popular in new-build settings. As well as ceramic, baths and brassware, the range includes beautifully designed towel radiators, glass shower enclosures, accessories and furniture.

Burlington brings the finest quality complete traditional bathroom ranges with genuine and inspired designs from the late 19th Century through to the 1930s.



## INSPIRATION

02  
RUSTIC CHARM

10  
WARMING NEUTRALS

18  
MODERN TRADITIONAL

28  
TIMELESS GOLD

36  
RIVIERA COLLECTION

44  
INDULGENTLY CLASSIC

54  
AUTHENTIC CHROME

64  
TECHNICAL DIRECTORY



# RUSTIC CHARM

**Comforting. Warm. Organic.**

Drawing on natural beauty, rustic bathrooms celebrate imperfections and welcome character into the home. A style where simple designs reign, rustic bathrooms unite stone, wood and other nature-inspired elements with a muted colour palette to bring individual charm. An enticing array of colours, textures and traditional fittings, rustic bathrooms effortlessly inspire comfort and contentment with their sense of familiarity.



Hampton 1500mm bath with traditional feet | Single bathscreen | Tay exposed shower with 9" shower head | Edwardian 560mm basin with full pedestal | Three tap hole mixer with Kensington handles | Towel ring, WC roll holder and WC brush holder | Distressed aluminium frame mirror | Round lights with vase glass shades | Regal close coupled WC with lever | Soft close seat, Oak | Bloomsbury radiator | All fittings, brassware and accessories are in Chrome



Left: Edwardian 560mm basin with full pedestal | 5" pillar tap with Claremont handles | Standard close coupled WC with lever | Soft close seat, White  
Above: London round bath | Deck mounted bath shower mixer with Black Kensington handles | Stand pipes | Brass extendible bath rack | All fittings, brassware and accessories are in Chrome



Left: Edwardian 800mm basin with washstand | Three tap hole mixer with Birkenhead handles | Soap dish / Above: Standard 520 low level WC with flush pipe and lever | Soft close seat, White | WC roll holder | All fittings, brassware and accessories are in Chrome



# WARMING NEUTRALS

**Subtle. Soothing. Mellow.**

Famed for their restorative properties, warming neutrals can help evoke positive emotions with their soft, balanced hues. A popular choice in classic and contemporary bathrooms alike, warming neutrals lay the perfect foundation for any era of design with a look that is set to remain timeless. A perfect pairing with expressive coloured finishes as much as minimalist designs, warming neutrals provide complete contentment without having to compromise on a look that dates.

Contemporary 580mm basin with semi pedestal | Mono basin mixer with Claremont handles | WC roll holder, single soap dispenser, triple robe hook and WC brush holder  
| Ornate lights with tube frosted glass | Wall hung WC with concealed cistern and lever | Soft close seat, White | All fittings, brassware and accessories are in Chrome



Curved 1340mm freestanding vanity unit with doors, White with Minerva Carrara marble worktop | Three tap hole mixer with Kensington handles | WC roll holder | Arched mirror | Ornate lights with vase glass shades | Standard 520 medium level WC with flush pipe and lever | Soft close seat, White | All fittings, brassware and accessories are in Chrome



Clockwise: Classic 510mm square basin with washstand | 3" pillar taps with Claremont handles / Classic 650mm rectangular basin with distressed aluminium washstand | 5" pillar taps with Claremont handles | Distressed aluminium frame mirror / Admiral 1650mm bath | Deck mounted bath shower mixer with Kensington handles | Stand pipes | All fittings, brassware and accessories are in Chrome





Right: Arcade 500mm cloakroom basin | Mini single basin mixer with crosshead lever / Above: Arcade 900mm basin with stand | WC roll holder | Arcade back to wall close coupled WC | Soft close seat, Gloss Black | All fittings, brassware and accessories are in Chrome





# MODERN TRADITIONAL

**Original. Timeless. Iconic.**

A seamless blend of classic and contemporary, modern traditional bathrooms unites extraordinary eras of design to instil newfound comfort. Revolving around an assortment of textures, colours and styles, modern traditional bathrooms can be as classic or contemporary as desired to match individual preference. Beautifully paired with Chrome, Gold or Nickel, modern traditional bathrooms create design freedom with a look that lasts.

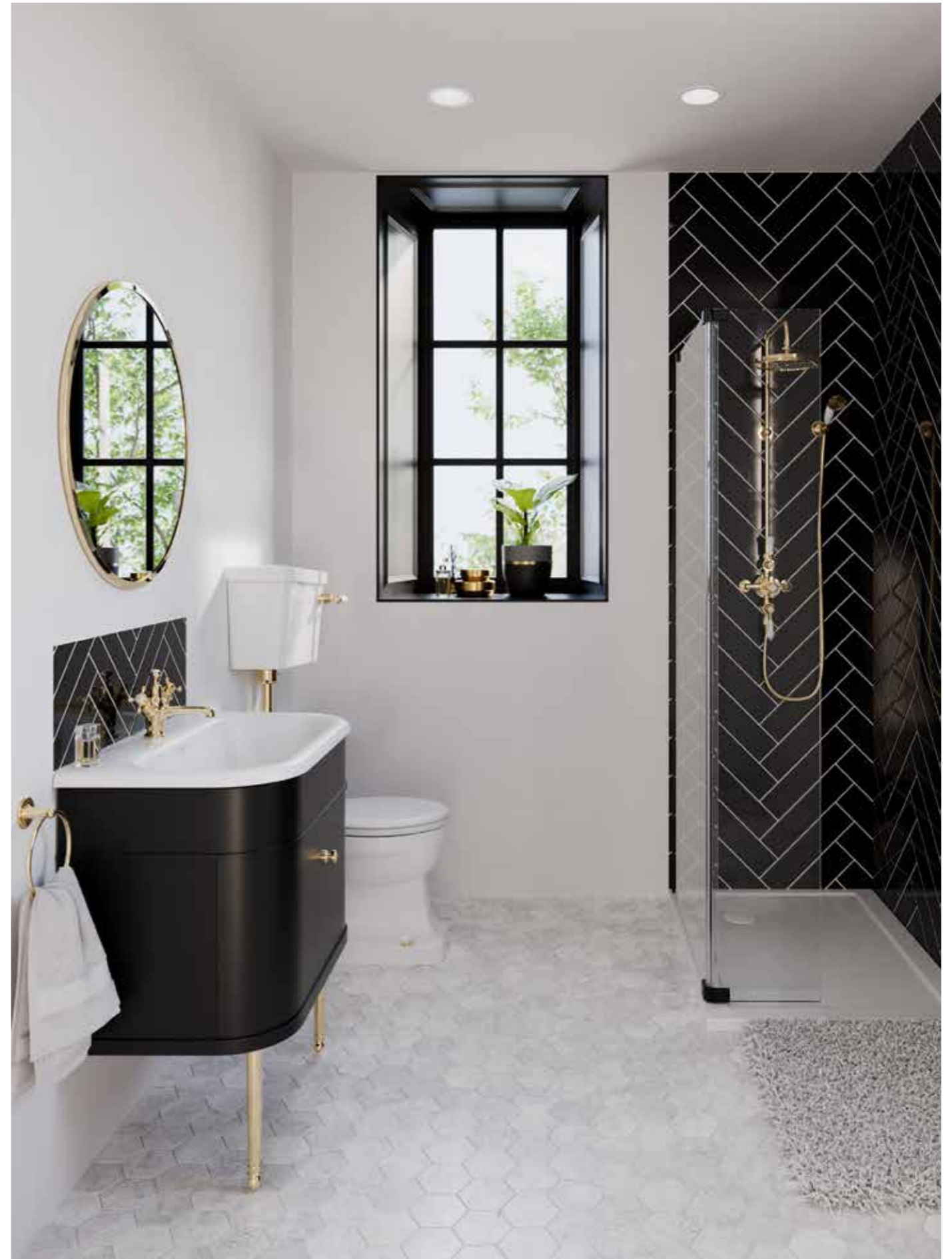

Chalfont 750mm vanity unit Black with large roll top basin, Gold legs and handle | Mono basin mixer with Claremont handles | Towel ring | Standard 520 low level WC with flush pipe, lever and cover caps | Soft close seat, White | Avon exposed shower with 9" shower head | All fittings, brassware and accessories are in Gold



Victorian 560mm basin with regal stand and towel rack | 3" pillar taps with Claremont handles | Tumbler, towel ring and WC roll holder | Standard 520 low level WC with flush pipe, lever and cover caps | Soft close seat, White | Arundel 1700mm x 700mm bath with panels, White | Deck mounted bath shower mixer | All fittings, brassware and accessories are in Gold

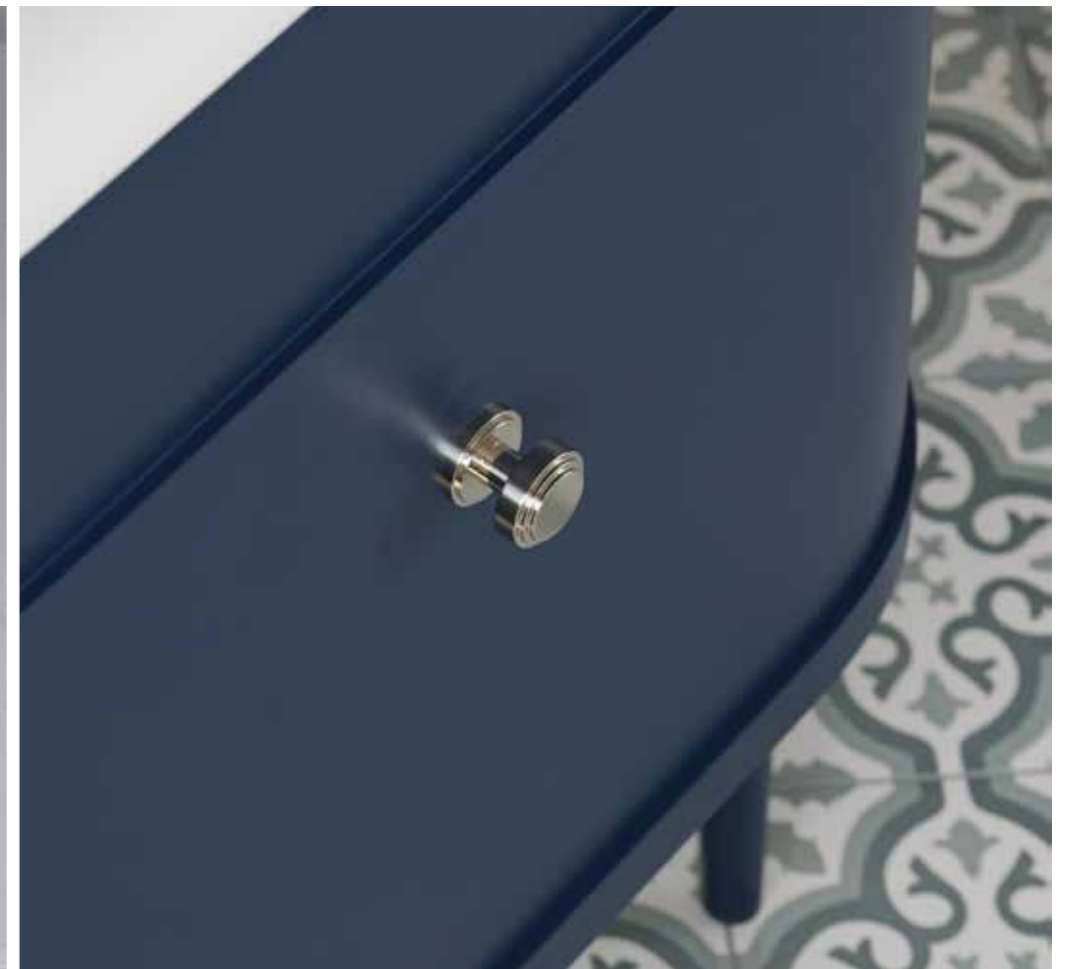

Chalfont 650mm vanity unit Blue with small roll top basin, Blue legs and Nickel handle | Arcade three tap hole mixer with crosshead lever | Tumbler holder, towel ring and WC roll holder | Rectangular swivel mirror | Oval lights with White fine pleated shade | Standard high level dual flush WC with flush pipe | Soft close seat, Blue | Bateau bath | All fittings, brassware and accessories are in Nickel



Edwardian 515mm cloakroom basin | 3" pillar taps with Claremont handles | Soap dish, towel ring, WC roll holder and WC brush holder | Rectangular mirror | Edwardian single round LED light | Back to wall WC with concealed cistern and lever | Soft close seat, White | All fittings, brassware and accessories are in Chrome



# TIMELESS GOLD

**Opulent. Indulgent. Ornate.**

Traditionally associated with power, wealth and success, Gold bathroom finishes hark back to Victorian and Edwardian eras to emphasise indulgence at its finest. Fast forward to recent years and Gold finishes continue to adorn bathrooms to this day, adding a warming touch to classic and contemporary settings alike. A rich and decadent colour, a Gold finish promises a sophisticated statement to complement a wide array of colour palettes.



Edwardian 515mm cloakroom basin with washstand | 3" pillar taps with Claremont handles | Towel ring and WC roll holder | Wall hung WC with concealed cistern and lever | Soft close seat, White | All fittings, brassware and accessories are in Gold





Admiral 1650mm bath | Deck mounted bath shower mixer with Claremont handles | Stand pipes / Standard low level WC with flush pipe, lever and cover caps | Soft close seat, Blue | WC roll holder | Towel ring | Regent basin mixer with Claremont handles | Curved 1340mm freestanding vanity unit with doors, Blue with Minerva Carrara marble worktop | Framed 1200mm mirror with LED illuminations, Blue | All fittings and accessories are in Gold



Chalfont 550mm vanity unit Blue with small roll top basin with Gold legs and handle | Mirrored cabinet, Blue | Soap dish and towel ring | Standard high level dual flush WC with flush pipe and cover caps | Soft close seat, Blue | All fittings and accessories are in Gold



# RIVIERA COLLECTION

**Lavish. Luxurious. Exclusive.**

Created in collaboration with Christian Booth Design, the Riviera Collection reignites the spirit of the 1920s with a curated selection of ceramics, vanity units and brassware. Drawing on the extravagance of the Mediterranean coasts, Riviera balances clean lines, geometric shapes and decorative embellishments to bring Art Deco designs into homes of today. Faithful to the original and entirely transitional, the Riviera Collection seeks to unite glamour, style and luxury in one comprehensive collection to inspire an Art Deco bathroom unlike any other.



Riviera dual valve, slide rail, handset and hose, and 9" shower head | Riviera 580mm D shaped basin with semi pedestal | Towel ring, shower basket and WC roll holder | Arched mirror | Round lights with tube frosted glass shades | Riviera wall hung WC with concealed cistern and lever | Riviera soft close seat | All fittings, brassware and accessories are in Chrome





Riviera 450mm cloakroom basin | Riviera pillar taps | Soap dish, towel ring and WC roll holder | Riviera back to wall WC with concealed cistern and lever | Riviera soft close seat | All fittings, brassware and accessories are in Gold



Riviera 650mm vanity unit White with handles and Riviera square basin | Riviera three tap hole mixer | Riviera wall hung WC with concealed cistern and Crosswater flush plate | Riviera soft close seat | Riviera four hole bath mixer including handset and pull out hose | Clearwater Patinato Petite Bath | All fittings, brassware and accessories are in Chrome



# INDULGENTLY CLASSIC

**Elegant. Time-honoured. Traditional.**

Known as the principles of art; balance, harmony and proportion are often cited within classic bathrooms inspired by eminent eras such as Victorian, Edwardian and Art Deco. Defined by symmetry, soft corners and structure, classic bathrooms maximise comfort with a look that's true to tradition. Embodying modern-day performance within a familiar look and feel, classic bathrooms unite form and function for elegantly refined designs.

Curved 1340mm freestanding vanity unit with drawers, Dark Olive with Minerva Carrara marble worktop | Regent three tap hole mixer with Kensington handles | Curved mirror | Ornate lights with vase glass shades | All fittings, brassware and accessories are in Chrome



Edwardian 1200mm basin with washstand | Three tap hole mixer with Claremont handles | Standard 440 medium level WC with Chrome cistern with flush pipe and lever | Soft close seat, White | Seat handles | All fittings, brassware and accessories are in Chrome





Bateau bath with claw feet | Deck mounted bath shower mixer with Black Kensington handles | Stand pipes | All fittings, brassware and accessories are in Chrome





Classic 650mm rectangular basin with invisible overflow with pedestal | 5" pillar taps with Claremont handles | Tumbler holder and towel ring | All fittings, brassware and accessories are in Chrome





Balthazar bath with stainless steel outer | Deck mounted bath shower mixer with Kensington handles | Stand pipes | All fittings, brassware and accessories are in Chrome



Left: 1300mm freestanding vanity unit with doors, White with Minerva Carrara marble worktop | Mono basin mixers with Kensington handles | Framed 1200mm mirror, White / Above Clockwise: Edwardian 515mm cloakroom basin | Towel rail | 3" pillar taps with Claremont handles / Victorian 610mm basin with full pedestal | Three tap hole mixer with Claremont handles | Towel ring and soap dish / Glass shelf with railings / Standard 520 medium level WC with flush pipe and lever | Soft close seat, Oak | All fittings, brassware and accessories are in Chrome



# AUTHENTIC CHROME

**Grand. Refined. Harmonious.**

As prestigious in homes of the late 1800s as it is today, Chrome finishes have continuously adorned bathrooms throughout the years with a lustrous and captivating finish. Gracefully understated or strikingly assertive, Chrome's gleaming aesthetic uplifts classic and contemporary settings with radiant design. Working in harmony with traditional bathroom fittings, Chrome adds a focal point to exude endless sophistication.



Chalfont 650mm vanity unit Black with medium roll top basin with Black legs and handle | Basin mixer with Black Claremont handles | Towel ring, WC roll holder and deep corner basket | Black aluminium framed mirror | Ornate lights with cup frosted glass shade | Standard 520 medium level WC with flush pipe and lever | Soft close seat, Matt Black | Avon exposed shower with Black handles | Trafalgar Black radiator | All fittings, brassware and accessories are in Chrome



Mirrored 600mm double door wall unit | 600mm double door wall unit | 300mm single door wall unit | 300mm single door base unit | 600mm WC unit and wall hung WC | Soft close seat, White | 600mm base unit | Contemporary 580mm semi recessed basin | Chelsea straight basin mixer with pop up waste | Minerva Carrara White 1200mm worktops with joining kit | Towel ring | Trafalgar radiator | All fittings, brassware and accessories are in Chrome



Clockwise: 1300mm freestanding vanity unit with doors, White with Minerva Carrara marble worktop | Chelsea straight basin mixers with pop up waste / Mirrored cabinet, White / Mono basin mixer with Claremont handles | All fittings, brassware and accessories are in Chrome



Victorian 610mm basin with full pedestal | 5" pillar taps with Claremont handles | Standard 520 close coupled WC with lever | Soft close seat, White | Avon exposed shower with 9" shower head | Sliding door enclosure and tray | Trafalgar radiator | All fittings, brassware and accessories are in Chrome







Arcade 1200mm double basin with ceramic console legs | Arcade single basin mixers with White ceramic lever | Albany bath | Arcade single lever bath shower filler with White ceramic lever | All fittings, brassware and accessories are in Chrome

# TECHNICAL DIRECTORY

You have now been introduced to the wide scope of the Burlington and Arcade ranges, all designed and engineered to provide solutions for your bathroom. The following Technical Directory provides a full listing of the Burlington and Arcade products including product codes and dimensions. Visit our website [burlingtonbathrooms.com](http://burlingtonbathrooms.com) or for our full database [bbwhitebook.com](http://bbwhitebook.com) if you need further details. Whatever you choose, we are sure you will be delighted with your traditional bathroom by Burlington.



Riviera 650mm vanity unit Blue with handles and Riviera square basin | Riviera three tap hole wall mounted mixer | Riviera back to wall WC with concealed cistern and lever | Riviera soft close seat | Soap dish | All fittings, brassware and accessories are in Chrome

## TECHNICAL DIRECTORY

66

WCs

82

BASINS

98

FURNITURE

114

BATHS

124

BRASSWARE

136

SHOWERING

154

ACCESSORIES

# WCs

The widest range of traditional WC options to suit your installation and match the exact look you want. Available in White with finish options of Chrome, Gold and Nickel flush pipes.

## PAN OPTIONS

Choose between Standard or Regal WCs with an option of Rimless pans available across a number of our products.



### Regal

At Burlington we've created a range that's taller than average sanitaryware. Regal WC pans are 60mm higher than the standard option.



### Standard

Our standard WC offers a pan that is 420mm with a box rim. A popular choice for creating a traditional look in your bathroom.



### Rimless

The rimless WC is exceptionally easy to keep clean. Its powerful flush covers the entire bowl, making it the most hygienic option.

## STYLE OPTIONS

Burlington has a wide range of WCs options. Select your style below.



Wall-hung



Back-to-wall



Close-coupled



Low level



Medium level



High level

## QUALITY

For peace of mind our WCs have the following benefits.



All Burlington close-coupled WCs are supplied with dual flush WRAS fittings.



All WCs have a unique stay-clean NANO Glaze coating, creating an ultra-smooth surface, six times smoother than standard ceramic.



All Burlington WC fittings are factory set at 3L and 6L flush. They can be adjusted on site to flush at 2 1/2L and 4 1/2L.

## GUARANTEES

\*The lifetime guarantee is subject to online registration and represents the perceived lifetime of the product which is 25 years. For full details on guarantees please visit [burlingtonbathrooms.com/guarantee](http://burlingtonbathrooms.com/guarantee).

WCs

**LIFETIME**

Guarantee\*

# WCs

68  
CLOSE COUPLED

70  
LOW LEVEL

72  
MEDIUM LEVEL

74  
HIGH LEVEL

76  
OTHERS

77  
ARCADE

78  
SEATS & ACCESSORIES

80  
RIVIERA

# CLOSE COUPLED

For alternative Lever finishes,  
See page 79.



## Standard Close Coupled WC

### 520 Cistern with Lever

W: 520 D: 730 H: 780

Codes: P5 + C1

### 440 Cistern with Lever

W: 440 D: 730 H: 780

Codes: P5 + C3

### 520 Cistern with Button

W: 520 D: 730 H: 780

Codes: P5 + C2

### 440 Cistern with Button

W: 440 D: 730 H: 780

Codes: P5 + C4



## S Trap Close Coupled WC

### 520 Cistern with Lever

W: 520 D: 710 H: 780

Codes: P18 + C1

### 440 Cistern with Lever

W: 440 D: 710 H: 780

Codes: P18 + C3

### 520 Cistern with Button

W: 520 D: 710 H: 780

Codes: P18 + C2

### 440 Cistern with Button

W: 440 D: 710 H: 780

Codes: P18 + C4

Back entry cistern option available, see page 79



## Regal Close Coupled WC

### 520 Cistern with Lever

W: 520 D: 730 H: 845

Codes: P12 + C1

### 440 Cistern with Lever

W: 440 D: 730 H: 845

Codes: P12 + C3

### 520 Cistern with Button

W: 520 D: 730 H: 845

Codes: P12 + C2

### 440 Cistern with Button

W: 440 D: 730 H: 845

Codes: P12 + C4



## Rimless Close Coupled WC

### 520 Cistern with Lever

W: 520 D: 730 H: 780

Codes: P20 + C1

### 440 Cistern with Lever

W: 440 D: 730 H: 780

Codes: P20 + C3

### 520 Cistern with Button

W: 520 D: 730 H: 780

Codes: P20 + C2

### 440 Cistern with Button

W: 440 D: 730 H: 780

Codes: P20 + C4

Please note: Seats sold separately



Available with  
Gold Levers.  
See page 79

For full details on our WC ranges go to [burlingtonbathrooms.com/guides/toilets](http://burlingtonbathrooms.com/guides/toilets)

# LOW LEVEL

For alternative Lever and Flush Pipe finishes,  
See page 79.



## Standard Low Level WC

**520 Cistern with Lever**  
W: 520 D: 740 H: 1075  
Codes: P2 + C1 + T31 CHR

**440 Cistern with Lever**  
W: 440 D: 740 H: 1075  
Codes: P2 + C3 + T31 CHR

**520 Cistern with Button**  
W: 520 D: 740 H: 1075  
Codes: P2 + C2 + T31 CHR

**440 Cistern with Button**  
W: 440 D: 740 H: 1075  
Codes: P2 + C4 + T31 CHR



## Standard Chrome Cistern Low Level WC

**440 Cistern with Lever**  
W: 440 D: 740 H: 1130  
Codes: P2 + T71 CHR + T31 CHR



## Regal Low Level WC

**520 Cistern with Lever**  
W: 520 D: 740 H: 1075  
Codes: P16 + C1 + T31 CHR

**440 Cistern with Lever**  
W: 440 D: 740 H: 1075  
Codes: P16 + C3 + T31 CHR

**520 Cistern with Button**  
W: 520 D: 740 H: 1075  
Codes: P16 + C2 + T31 CHR

**440 Cistern with Button**  
W: 440 D: 740 H: 1075  
Codes: P16 + C4 + T31 CHR



## S Trap Low Level WC

**520 Cistern with Lever**  
W: 520 D: 740 H: 1075  
Codes: P19 + C1 + T31 CHR

**440 Cistern with Lever**  
W: 440 D: 740 H: 1075  
Codes: P19 + C3 + T31 CHR

**520 Cistern with Button**  
W: 520 D: 740 H: 1075  
Codes: P19 + C2 + T31 CHR

**440 Cistern with Button**  
W: 440 D: 740 H: 1075  
Codes: P19 + C4 + T31 CHR



For full details on our WC ranges go to [burlingtonbathrooms.com/guides/toilets](http://burlingtonbathrooms.com/guides/toilets)

Please note: Seats sold separately

Back entry cistern option available, see page 79

# MEDIUM LEVEL



## Standard Medium Level WC

**520 Cistern with Lever**      **440 Cistern with Lever**  
**W: 520 D: 720 H: 1425**      **W: 440 D: 720 H: 1425**  
**Codes: P5 + C1 + T33 CHR**      **Codes: P5 + C3 + T33 CHR**

**520 Cistern with Button**      **440 Cistern with Button**  
**W: 520 D: 720 H: 1425**      **W: 440 D: 720 H: 1425**  
**Codes: P5 + C2 + T33 CHR**      **Codes: P5 + C4 + T33 CHR**



## S Trap Medium Level WC

**520 Cistern with Lever**      **440 Cistern with Lever**  
**W: 520 D: 710 H: 1425**      **W: 440 D: 710 H: 1425**  
**Codes: P18 + C1 + T33 CHR**      **Codes: P18 + C3 + T33 CHR**

**520 Cistern with Button**      **440 Cistern with Button**  
**W: 520 D: 710 H: 1425**      **W: 440 D: 710 H: 1425**  
**Codes: P18 + C2 + T33 CHR**      **Codes: P18 + C4 + T33 CHR**

Back entry cistern option available, see page 79



## Regal Medium Level WC

**520 Cistern with Lever**      **440 Cistern with Lever**  
**W: 520 D: 720 H: 1425**      **W: 440 D: 720 H: 1425**  
**Codes: P12 + C1 + T33 CHR**      **Codes: P12 + C3 + T33 CHR**

**520 Cistern with Button**      **440 Cistern with Button**  
**W: 520 D: 720 H: 1425**      **W: 440 D: 720 H: 1425**  
**Codes: P12 + C2 + T33 CHR**      **Codes: P12 + C4 + T33 CHR**



## Standard Chrome Level Medium Level WC

**440 Cistern with Lever**  
**W: 440 D: 730 H: 1425**  
**Codes: P5 + T71 CHR + T33 CHR**



## Rimless Medium Level WC

**520 Cistern with Lever**      **440 Cistern with Lever**  
**W: 520 D: 720 H: 1425**      **W: 440 D: 720 H: 1425**  
**Codes: P20 + C1 + T33 CHR**      **Codes: P20 + C3 + T33 CHR**

**520 Cistern with Button**      **440 Cistern with Button**  
**W: 520 D: 720 H: 1425**      **W: 440 D: 720 H: 1425**  
**Codes: P20 + C2 + T33 CHR**      **Codes: P20 + C4 + T33 CHR**

# CHOOSE YOUR PAN

Choose between Standard or Regal WCs with an option of Rimless pans available across a number of our products.

### Standard

Our standard WC offers a pan that is 420mm with a box rim. A popular choice for creating a traditional look in your bathroom.

### Regal

At Burlington we've created a range that's taller than average sanitaryware. Regal WC pans are 60mm higher than the standard option.

### Rimless

The rimless WC is exceptionally easy to keep clean. Its powerful flush covers the entire bowl, making it the most hygienic option.

For full details on our WC ranges go to [burlingtonbathrooms.com/guides/toilets](http://burlingtonbathrooms.com/guides/toilets)

Please note: Seats sold separately

# HIGH LEVEL

For alternative Lever and Flush Pipe finishes, See page 79.



## Standard High Level WC

**520 Cistern with Dual Flush**  
**W: 520 D: 670 H: 2380**  
**Codes: P2 + C5 + T30 CHR**

**520 Cistern with Single Flush**  
**W: 520 D: 670 H: 2380**  
**Codes: P2 + C28S + T30 CHR**

**430 Aluminium Cistern with Dual Flush**  
**W: 430 D: 670 H: 2380**  
**Brushed: P2 + T58 ALU + T30 CHR**  
**Black: P2 + T60 BLA + T30 CHR**  
**White: P2 + T59 WHI + T30 CHR**

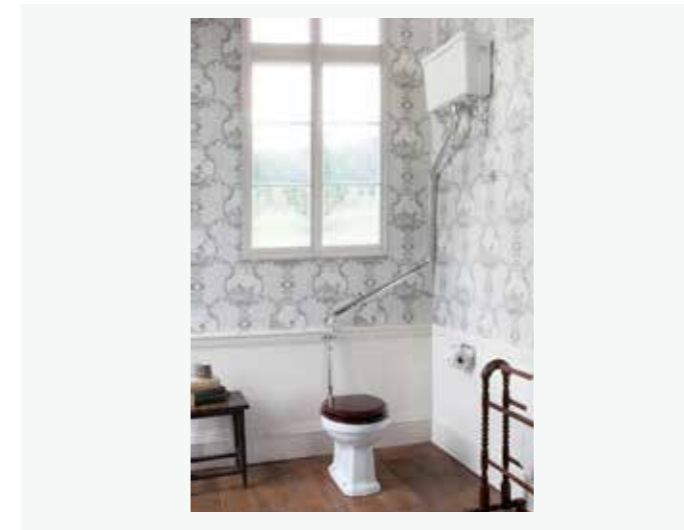

## High Level WC with Angled Flush Pipe

**520 Cistern with Dual Flush**  
**W: 905 D: 700 H: 2725**  
**Codes: P2 + C5 + T34 CHR**

Angled flush pipes can be ordered as an extra on all high level WCs



## Regal High Level WC

**520 Cistern with Dual Flush**  
**W: 520 D: 670 H: 2380**  
**Codes: P16 + C5 + T30 CHR**

**520 Cistern with Single Flush**  
**W: 520 D: 670 H: 2380**  
**Codes: P16 + C28S + T30 CHR**

**430 Aluminium Cistern with Dual Flush**  
**W: 430 D: 670 H: 2380**  
**Brushed: P16 + T58 ALU + T30 CHR**  
**Black: P16 + T60 BLA + T30 CHR**  
**White: P16 + T59 WHI + T30 CHR**



## High Level Chrome WC

**440 Cistern with Dual Flush**  
**W: 440 D: 670 H: 2400**  
**Codes: P2 + T70 CHR + T30 CHR**



## S Trap High Level WC

**520 Cistern with Dual Flush**  
**W: 520 D: 670 H: 2380**  
**Codes: P19 + C5 + T30 CHR**

**520 Cistern with Single Flush**  
**W: 520 D: 670 H: 2380**  
**Codes: P19 + C28S + T30 CHR**

**430 Aluminium Cistern with Dual Flush**  
**W: 440 D: 670 H: 2380**  
**Brushed: P19 + T58 ALU + T30 CHR**  
**Black: P19 + T60 BLA + T30 CHR**  
**White: P19 + T59 WHI + T30 CHR**

## REGAL WCs

At Burlington we've created a range that's taller than average sanitaryware. Regal WC pans are 60mm higher than the standard option.

At 480mm high the taller WC pan ensures the knee angle remains at approximately 90 degrees whilst in use, which is the correct seating position. The taller WC provides a more comfortable use for taller people and the elderly whilst ensuring your WC is functional as well as beautiful too.



For full details on our WC ranges go to [burlingtonbathrooms.com/guides/toilets](http://burlingtonbathrooms.com/guides/toilets)

Please note: Seats sold separately

Back entry cistern option available, see page 79

All measurements are represented in mm.

For detailed dimensions see [bbwhitebook.com](http://bbwhitebook.com)

## OTHERS



### Back to Wall

**Standard**  
**W: 360 D: 475 H: 425**  
**Code: P14**

**Regal**  
**W: 370 D: 480 H: 480**  
**Code: P15**

**Standard Rimless**  
**W: 360 D: 480 H: 420**  
**Code: P21**



### Wall Hung

**W: 335 D: 500**  
**Code: P10**



### Bidets

**Floorstanding**  
**W: 400 D: 570 H: 400**  
**Code: P4**

**Wall Hung**  
**W: 370 D: 500**  
**Code: P11**

Please note: Seats sold separately

## ARCADE



### Arcade

**Close Coupled**  
**W: 500 D: 670 H: 885**  
**Codes: ARC4 + ARC5**

**Back to Wall**  
**W: 365 D: 520 H: 460**  
**Code: ARC6**



For full details on our WC ranges go to [burlingtonbathrooms.com/guides/toilets](http://burlingtonbathrooms.com/guides/toilets)



# SEATS & ACCESSORIES

Our WC seats match our furniture.  
See page 102 for the full range.



Matt White soft-close seat  
(excluding handles)  
**Code:** S45



Sand soft-close seat  
(excluding handles)  
**Code:** S43



Classic Grey soft-close seat  
(excluding handles)  
**Code:** S46

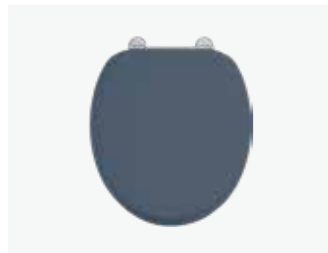

Blue soft-close seat  
(excluding handles)  
**Code:** S99

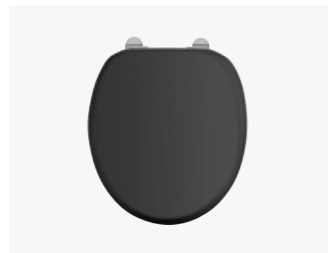

Black soft-close seat  
(excluding handles)  
**Matt:** S48  
**Gloss:** S40



Medici soft-close seat  
(excluding handles)  
**Code:** S50



Oak seat  
(excluding handles)  
**Standard:** S11  
**Soft-close:** S16



Gloss Mahogany seat  
(excluding handles)  
**Standard:** S12  
**Soft-close:** S17



White carbamide seat  
(not suitable for handles)  
**Standard:** S13  
**Soft-close:** S18  
Note: Gold and Nickel seat hinges are not compatible with the above seats.



Seat handles  
(Sold in pairs)  
**Chrome:** A51 CHR  
**Gold:** A51 GOLD



Wooden seat hinges  
(Seats supplied with Chrome hinges)  
**Nickel:** A75 NKL  
**Gold:** SP813



Gold cover caps for WCs  
(Sold in pairs)  
**Code:** SP387



Ceramic trap for converting  
P trap to S trap  
**Code:** C26



Straight ceramic trap  
**Code:** C29



Back entry 520mm deep  
lever cistern  
**Code:** C30

## WC Rear Entry Options

Burlington cisterns are available with either bottom or back entry filling for flexible installation.

If you need to fill your cistern from the back, please order the below.

**Back entry 520mm deep lever cistern (Code: C30)**

(This deep cistern increases the distance from pan outlet to the wall by 20mm)

# FLUSH OPTIONS

Our feature cistern levers are available in Gold, Nickel or Black and create the perfect finishing touch. They work beautifully with our other feature options such as WC seats, brassware and accessories.



**Black Lever**  
To add a Black Lever please add BLA to end of the code.

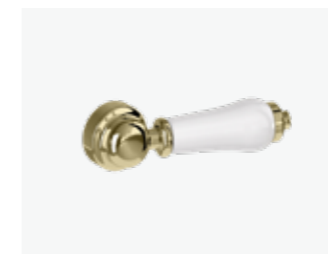

**Gold Lever**  
To add a Gold Lever please order a SP390 GOLD.



**Nickel Lever**  
To add a Nickel Lever please order a SP8 NKL.,



**Gold Flush Pipes**  
Available for our low level and high level toilets only.  
**Low Level:** T31 GOLD  
**High Level:** T30 GOLD

**Black Pull Lever**  
To add a Black Pull Lever (C28S cistern only) please add BLA to end of the code.

**Gold Dual Flush Lever**  
Available for our high level toilets only (not available on C28S cisterns)  
**Code:** SP391 GOLD

**Nickel Dual Flush Lever**  
Available for our high level toilets only (not available on C28S cisterns)  
**Code:** SP391 NKL

**Nickel Flush Pipes**  
Available for our low level and high level toilets only.  
**Low Level:** T31 NKL  
**High Level:** T30 NKL

# RIVIERA

For the full Riviera range visit  
[burlingtonbathrooms.com/riviera](http://burlingtonbathrooms.com/riviera)



Riviera Close Coupled Open Back WC

**Close Coupled Open Back**  
**W:** 357 **D:** 660 **H:** 820  
**Codes:** RIV9 + RIV11 + RIV.025

Includes Chrome lever  
and seat.



Riviera Wall Hung WC

**Wall Hung**  
**W:** 359 **D:** 535 **H:** 420  
**Codes:** RIV13 + RIV.025

Concealed Cistern including Lever  
**Chrome:** F6CC RIVCP

**Gold:** F6CC RIVGP

Includes seat.



Riviera Close Couple Full Back To Wall WC

**Close Coupled Back to Wall**  
**W:** 357 **D:** 660 **H:** 820  
**Codes:** RIV10 + RIV11 + RIV.025

Includes Chrome lever  
and seat.



Riviera Back to Wall WC

**Back to Wall**  
**W:** 359 **D:** 535 **H:** 420  
**Codes:** RIV12 + RIV.025

Includes seat.

## FINISHING OPTIONS

Gold and Nickel finishes are available for toilet seat hinges and cistern levers.  
The cisterns and seats are supplied with Chrome as standard, simply add the option of Gold or Nickel as to match with the brassware.

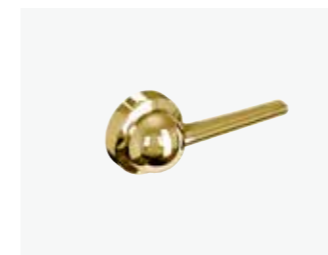

**Gold Lever**  
To add a Gold Lever please  
order a ARCSP6 GOLD.



**Nickel Lever**  
To add a Nickel Lever  
please order a ARCSP6.



**Riviera Soft Close Seat**  
**Seat with Chrome:** RIV.025  
**Gold Hinges:** RIV.030  
**Nickel Hinges:** RIV.031

For full details on our WC ranges go to [burlingtonbathrooms.com/guides/toilets](http://burlingtonbathrooms.com/guides/toilets)

# BASINS

From large double basins to compact cloakroom options, Burlington offers a wide range of basins with many styles and sizes perfectly formed to suit your traditional bathroom.

## STYLE OPTIONS

Burlington has a wide range of Basin options. Select your style below.

### Classic



The Classic collection from Burlington is beautifully formed, available in rectangular or square designs, complete with an invisible waste option.

### Edwardian



The Edwardian collection is the ultimate in traditional bathrooms with structured corners and angular designs, the feel is unapologetic and proud.

### Victorian



Delicate and refined, the simplicity of this basin is stunning whilst its versatility allows you to continue the style through your home and brings an air of luxury.

### Contemporary



As the name suggests, the Contemporary collection is styled on the elegance of past times but with a modern day twist. Simplistic, structured lines form the basis for this striking ceramic collection.

### Cloakroom



A choice of traditionally designed cloakroom basins to achieve a consistent look throughout the home.

## ADDITIONS

Some of our washstands have the option to add additional features including a towel rack or rail.



Towel Rails



Towel Racks

## REGAL

Burlington Regal pedestals and washstands are higher than standard, making them more comfortable for taller people, the elderly or those prone to back pain.

	Standard	Regal
Classic	860mm	920mm
Victorian	840mm	900mm
Edwardian	840mm	900mm
Contemporary	840mm	900mm
Washstands	840mm	900mm



Standard

Regal

## GUARANTEES

\*The lifetime guarantee is subject to online registration and represents the perceived lifetime of the product which is 25 years. For full details on guarantees please visit [burlingtonbathrooms.com/guarantee](http://burlingtonbathrooms.com/guarantee).

Basins

**LIFETIME**

Guarantee\*

# BASINS

84

CLASSIC

86

EDWARDIAN

88

VICTORIAN

89

CONTEMPORARY

90

NATURAL STONE

92

CLOAKROOM

94

ARCADE

96

RIVIERA

# CLASSIC BASINS



Classic 510mm Square Basin

**With Chrome Washstand**

**W:** 510 **D:** 450 **H:** 890

**Codes:** B20\* + T52 CHR

**With Gold Washstand**

**W:** 510 **D:** 450 **H:** 890

**Codes:** B20\* + T52 GOLD

Available with a Regal washstand. See page 89 for more details.



Classic 650mm Rectangular Basin with Invisible Overflow

**With Chrome Washstand**

**W:** 650 **D:** 575 **H:** 860

**Codes:** B14 2TH + T49A CHR

**With Pedestal**

**W:** 650 **D:** 575 **H:** 860

**Codes:** B14 2TH + P6

**Invisible Overflow & Waste**

**W:** 74 **D:** 74 **H:** 300

**Code:** W9



Available with a Regal washstand. See page 89 for more details.



Classic 650mm Rectangular Basin

**With Chrome Washstand**

**W:** 650 **D:** 575 **H:** 830

**Codes:** B15\* + T49A CHR

**With Pedestal**

**W:** 650 **D:** 575 **H:** 860

**Codes:** B15\* + P6

**With Gold Washstand**

**W:** 650 **D:** 575 **H:** 830

**Codes:** B15\* + T49A GOLD

Available with a Regal washstand. See page 89 for more details.



Classic 650mm Rectangular Basin with Invisible Overflow and Aluminium Washstands

**With Aluminium Washstand**

**W:** 560 **D:** 470 **H:** 840

**Distressed:** B14 2TH + T38 ALU

**Black:** B14 2TH + T48 BLA

**White:** B14 2TH + T43 WHI

**Invisible Overflow & Waste**

**W:** 74 **D:** 74 **H:** 300

**Code:** W9



Classic 650mm Rectangular Basin with Aluminium Washstands

**With Aluminium Washstand**

**W:** 650 **D:** 575 **H:** 830

**Distressed:** B15\* + T38 ALU

**Black:** B15\* + T48 BLA

**White:** B15\* + T43 WHI

## INVISIBLE OVERFLOW WASTE

Available with the Classic collection as a two tap hole configuration. The benefit of invisible overflow is that the ceramic of the beautiful basins is un-interrupted with no requirement for a plug or external waste. Simply pull the lever to drain water. Pair with the elegant and beautiful Arch basin mixer allowing you to mix hot and cold water. See page 48 for an example.

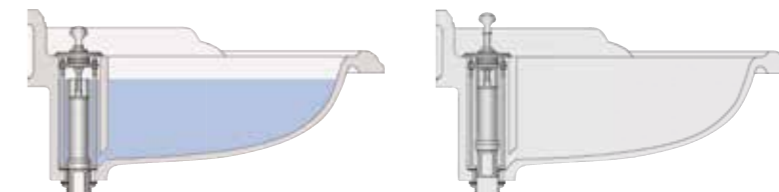

For full details on our basin ranges go to [burlingtonbathrooms.com/guides/basins](http://burlingtonbathrooms.com/guides/basins)

\* Available with 1, 2 or 3 tap holes. To order the correct basin configuration replace \* with 1TH, 2TH or 3TH.

# EDWARDIAN BASINS



## Edwardian 560mm Rectangular Basin

### With Chrome Washstand

W: 560 D: 470 H: 840

Codes: B4\* + T22A CHR

### With Pedestal

W: 560 D: 470 H: 840

Codes: B4\* + P1

### With Gold Washstand

W: 560 D: 470 H: 840

Codes: B4\* + T22A GOLD

### With Semi Pedestal

W: 560 D: 470 H: 840

Codes: B4\*\* + P8

Available with a Regal washstand/pedestal. See page 89 for more details.



## Edwardian 1200mm Rectangular Basin

### With Chrome Washstand

W: 1200 D: 510 H: 840

Codes: B19\* + T51 CHR

### With Pedestal

W: 1200 D: 510 H: 840

Codes: B19\* + P6

### With Gold Washstand

W: 1200 D: 510 H: 840

Codes: B19\* + T51 GOLD

Available with a Regal washstand. See page 89 for more details.



## Edwardian 610mm Rectangular Basin

### With Chrome Washstand

W: 610 D: 510 H: 840

Codes: B5\* + T23A CHR

### With Pedestal

W: 610 D: 510 H: 840

Codes: B5\* + P1

### With Gold Washstand

W: 610 D: 510 H: 840

Codes: B5\* + T23A GOLD

### With Semi Pedestal

W: 610 D: 510 H: 840

Codes: B5\*\* + P8

Available with a Regal washstand/pedestal. See page 89 for more details.



## Edwardian 1200mm Double Rectangular Basin

### With Chrome Washstand

W: 1200 D: 510 H: 840

Codes: B21\* + T51 CHR

### With Gold Washstand

W: 1200 D: 510 H: 840

Codes: B21\* + T51 GOLD

Available with a Regal washstand. See page 89 for more details.



## Edwardian 800mm Rectangular Basin

### With Chrome Washstand

W: 800 D: 510 H: 840

Codes: B18\* + T50 CHR

### With Pedestal

W: 800 D: 510 H: 840

Codes: B18\* + P6

### With Gold Washstand

W: 800 D: 510 H: 840

Codes: B18\* + T50 GOLD

Available with a Regal washstand. See page 89 for more details.



## Edwardian 560mm Round Basin

### With Chrome Washstand

W: 560 D: 470 H: 840

Codes: B6\* + T24A CHR

### With Pedestal

W: 560 D: 470 H: 840

Codes: B6\* + P1

### With Gold Washstand

W: 560 D: 470 H: 840

Codes: B6\* + T24A GOLD

Also available with an optional towel rail. See page 90 for more information.

Available with a Regal washstand. See page 89 for more details.

\* Available with 1, 2 or 3 tap holes. To order the correct basin configuration replace \* with 1TH, 2TH or 3TH.  
 \*\* 3TH is not available with semi pedestals

## VICTORIAN BASINS



Victorian 560mm Rectangular Basin

**With Chrome Washstand**

W: 560 D: 470 H: 840

Codes: B2\* + T22A CHR

**With Pedestal**

W: 560 D: 470 H: 840

Codes: B2\*\* + P1

**With Gold Washstand**

W: 560 D: 470 H: 840

Codes: B2\* + T22A GOLD

**With Semi Pedestal**

W: 560 D: 470 H: 840

Codes: B2\*\* + P8

Available with a Regal washstand/pedestal. See right hand side for more details.



Victorian 610mm Rectangular Basin

**With Chrome Washstand**

W: 610 D: 510 H: 840

Codes: B3\* + T23A CHR

**With Pedestal**

W: 610 D: 510 H: 840

Codes: B3\* + P1

**With Gold Washstand**

W: 610 D: 510 H: 840

Codes: B3\* + T23A GOLD

**With Semi Pedestal**

W: 610 D: 510 H: 840

Codes: B3\*\* + P8

Available with a Regal washstand/pedestal. See right hand side for more details.

## CONTEMPORARY BASINS



Contemporary 580mm Rectangular Basin

**With Chrome Washstand**

W: 580 D: 470 H: 840

Codes: B1\* + T22A CHR

**With Pedestal**

W: 580 D: 470 H: 840

Codes: B1\* + P1

**With Gold Washstand**

W: 580 D: 470 H: 840

Codes: B1\* + T22A GOLD

**With Semi Pedestal**

W: 580 D: 470 H: 840

Codes: B1\*\* + P8

Available with a Regal washstand/pedestal. See below for more details.



Semi-recessed Basins

**540 Countertop**

W: 540 D: 425

Code: B13\*

**580 Semi-recessed**

W: 575 D: 470

Code: B12\*

## ADDITIONAL CHOICES

Optional towel racks and towel rails are available for adding extra storage or space for towels in your bathroom. Towel racks are only compatible with washstands T22A and T23A and towel rails can be added to Victorian and Edwardian basins.

### Towel Rails

**Rectangular Basins**  
560 Basin: T1 CHR  
610 Basin: T3 CHR

**Round Basins**  
560 Basin: T4 CHR



### Towel Racks

**For 560mm and 580mm Washstands**  
Chrome: T22A-S  
Gold: T22A-S GOLD

**For 610mm Washstands**  
Chrome: T23A-S  
Gold: T23A-S GOLD



## REGAL OPTIONS

Burlington Regal pedestals and washstands are higher than standard, making them more comfortable for taller people, the elderly or those prone to back pain.

### Washstands

To order a regal washstand choose from a T62 or T62 GOLD depending on the chosen finish of your washstand.

**Chrome Washstand**  
Code: T62

**Gold Washstand**  
Code: T62 GOLD

### Pedestals

To order a regal pedestal select a P9. The Regal pedestal is compatible with the B1, B2, B3, B4, B5 and B6 basins only.

**Regal Pedestal**  
Code: P9

For full details on our basin ranges go to [burlingtonbathrooms.com/guides/basins](http://burlingtonbathrooms.com/guides/basins)

\* Available with 1, 2 or 3 tap holes. To order the correct basin configuration replace \* with 1TH, 2TH or 3TH.  
\*\* 3TH is not available with semi pedestals

# NATURAL STONE BASINS

These basins can also be paired with our Chalfont furniture. See page 110 for details.



Natural Stone Small 550mm Rectangular Basin

**With Stainless Steel Washstand**

**W: 550 D: 470 H: 880**

**Codes: B7E\* + B7ES**

**Upstand Basin with Stainless Steel Washstand**

**W: 550 D: 470 H: 880**

**Codes: B7E UPS + B7ES**

This can also be wall mounted but will require basin brackets:

**Codes: B7E UPS + TZJ.550**

This upstand basin is designed to work with Riviera wall mounted basin mixers only.



Natural Stone Double 1000mm Rectangular Basin

**With Stainless Steel Washstand**

**W: 1000 D: 470 H: 880**

**Codes: B10DE\* + B10ES**



Natural Stone Medium 650mm Rectangular Basin

**With Stainless Steel Washstand**

**W: 650 D: 470 H: 880**

**Codes: B8E\* + B8ES**

**Upstand Basin with Stainless Steel Washstand**

**W: 650 D: 470 H: 880**

**Codes: B8E UPS + B8ES**

This can also be wall mounted but will require basin brackets:

**Codes: B8E UPS + TZJ.650**

This upstand basin is designed to work with Arcade wall mounted basin mixers only.



Natural Stone Large 750mm Rectangular Basin

**With Stainless Steel Washstand**

**W: 750 D: 470 H: 880**

**Chrome: B9E\* + B9ES**



For full details on our basin ranges go to [burlingtonbathrooms.com/guides/basins](http://burlingtonbathrooms.com/guides/basins)

\* Available with 1, 2 or 3 tap holes. To order the correct basin configuration replace \* with 1TH, 2TH or 3TH.

# CLOAKROOM BASINS



Edwardian Cloakroom 515mm Basin  
with Washstands

**With Chrome Washstand**

**W:** 515 **D:** 308 **H:** 825

**Codes:** B8\* + T21A CHR

**With Gold Washstand**

**W:** 515 **D:** 308 **H:** 825

**Codes:** B8\* + T21A GOLD

Available with a Regal washstand. See below for more details.



Edwardian

Curved

Corner

## Cloakroom Basins

**Edwardian 515**

**W:** 515 **D:** 308

**Code:** B8\*

**Curved 505**

**W:** 505 **D:** 255

**Code:** P13\*

**Corner 600**

**W:** 600 **D:** 450

**Code:** B10



# REGAL OPTIONS

Burlington Regal pedestals and washstands are higher than standard, making them more comfortable for taller people, the elderly or those prone to back pain.

## Washstands

To order a regal washstand choose from a T62 or T62 GOLD depending on the chosen finish of your washstand.

**Chrome Washstand**  
**Code:** T62

**Gold Washstand**  
**Code:** T62 GOLD

## Pedestals

To order a regal pedestal select a P9. The Regal pedestal is compatible with the B1, B2, B3, B4, B5 and B6 basins only.

**Regal Pedestal**  
**Code:** P9

## Towel Rails

Add a towel rail onto your Cloakroom Edwardian basin by ordering the below code;

**515 Basin:** T6 CHR



# ADDITIONAL CHOICES

For full details on our basin ranges go to [burlingtonbathrooms.com/guides/basins](http://burlingtonbathrooms.com/guides/basins)

\* Available with 1, 2 or 3 tap holes. To order the correct basin configuration replace \* with 1TH, 2TH or 3TH.



# ARCADE BASINS



Arcade 600mm Basin

**With Chrome Washstand**

**W: 605 D: 525 H: 840**

**Codes: ARC600\* + ARC22 CHR**

**With Pedestal**

**W: 605 D: 525 H: 840**

**Codes: ARC600\* + ARC1**

**With Nickel Washstand**

**W: 605 D: 525 H: 840**

**Codes: ARC600\* + ARC22**

**With Legs**

**W: 605 D: 525 H: 840**

**Codes: ARC600\* + ARC2**



Arcade 500mm Cloakroom Basin

**W: 500 D: 400**

**Code: ARC500\***



Arcade 900mm Basin

**With Chrome Washstand**

**W: 905 D: 550 H: 840**

**Codes: ARC900\* + ARC23 CHR**

**With Pedestal**

**W: 905 D: 550 H: 840**

**Codes: ARC900\* + ARC1**

**With Nickel Washstand**

**W: 905 D: 550 H: 840**

**Codes: ARC900\* + ARC23**

**With Legs**

**W: 905 D: 550 H: 840**

**Codes: ARC900\* + ARC2**



Arcade 1200mm Double Basin

**With Chrome Washstand**

**W: 1215 D: 560 H: 840**

**Codes: ARC1200\* + ARC24 CHR**

**With Nickel Washstand**

**W: 1215 D: 560 H: 840**

**Codes: ARC1200\* + ARC24**

**With Legs**

**W: 1215 D: 560 H: 840**

**Codes: ARC1200\* + ARC2**



For full details on our basin ranges go to [burlingtonbathrooms.com/guides/basins](http://burlingtonbathrooms.com/guides/basins)

\* Available with 0, 1, 2 or 3 tap holes. To order the correct basin configuration replace \* with NTH, 1TH, 2TH or 3TH.

# RIVIERA BASINS

For the full Riviera range visit  
[burlingtonbathrooms.com/riviera](http://burlingtonbathrooms.com/riviera)



Riviera 580mm D Shaped Basin

**With Pedestal**  
**W: 580 D: 470 H: 847**  
**Codes: RIV3\* + RIV6**

**With Semi Pedestal**  
**W: 580 D: 470 H: 847**  
**Codes: RIV3\* + RIV7**



Riviera 580mm Square Shaped Basin

**With Pedestal**  
**W: 580 D: 470 H: 847**  
**Codes: RIV1\* + RIV6**

**With Semi Pedestal**  
**W: 580 D: 470 H: 847**  
**Codes: RIV1\* + RIV7**



Riviera 650mm D Shaped Basin

**With Pedestal**  
**W: 650 D: 470 H: 847**  
**Codes: RIV4\* + RIV6**

**With Semi Pedestal**  
**W: 650 D: 470 H: 847**  
**Codes: RIV4\* + RIV7**



Riviera 650mm Square Shaped Basin

**With Pedestal**  
**W: 650 D: 470 H: 847**  
**Codes: RIV2\* + RIV6**

**With Semi Pedestal**  
**W: 650 D: 470 H: 847**  
**Codes: RIV2\* + RIV7**



Riviera Semi-recessed

**580 Semi-recessed**  
**W: 580 D: 470**  
**Codes: RIV5\***



Riviera Cloakroom Basin

**450 Square Cloakroom**  
**W: 450 D: 320**  
**Codes: RIV8 2TH**

The Cloakroom basin is 2 taphole only and is not designed for use with either pedestal.

\* Available with 1, 2 or 3 tap holes. To order the correct basin configuration replace \* with 1TH, 2TH or 3TH.

# FURNITURE

A range of beautifully traditional furniture solutions to add classic style and sophisticated British elegance to your bathroom. Choose from freestanding in either square or curved design, cloakroom or fully fitted options to create the most functional space to suit your individual needs.

## KEY FEATURES

Our furniture solutions are made from the finest materials and offer innovative features and smart details. Perfectly suited for the bathroom environment.



Classic



Chalfont



Riviera



The plinths of the freestanding furniture are crafted from a waterproof high density material - providing extra protection and giving peace of mind that wet floors will not lead to damage.



Available in 4 sizes and 3 colours with the design option to have wall hung or floor standing by using additional legs available in wood with matching paint finishes or in brass with a Chrome, Gold or Nickel finish to compliment the Burlington brassware ranges.



Available as floor-standing in 2 sizes and 3 colours with matching handles available in Chrome or Gold finishes.



Made from materials specifically selected to withstand the rigours of life in the bathroom where temperature and humidity can vary widely.



Each of our Classic furniture pieces are prepared with 5 layers of primer featuring UV stabilisation to minimise colour fading from exposure to sunlight. The painted top coat is then applied for a glorious depth of colour.



All of our Chalfont furniture pieces have a high quality paint finish and are prepared with 3 layers of primer featuring UV stabilisation to minimise colour fading from exposure to sunlight. Followed by 2 layers of top coat for a glorious depth of colour.



Each part is coated with five layers of primer, before the final coating is applied; this top coat is UV-resistant to reduce the effects of exposure to bright sunlight.



Unlike conventional fitted furniture, our units offer full floor to height storage providing increased space for all your bathroom cosmetics and accessories.



Chalfont furniture units pair exclusively with Burlington's natural stone roll top basins. Natural stone's beautiful and tactile appearance is also extremely hard wearing and minor scuffs and scrapes are, in most cases, easily polished and smoothed away. These basins are supplied undrilled for your preferred choice of 1, 2 or 3 tap holes.



Riviera vanity units are supplied fully assembled for simple installation, with adjustable feet to ensure stability and protect them from wet floors.

## GUARANTEES

\*For full details on guarantees please visit [burlingtonbathrooms.com/guarantee](http://burlingtonbathrooms.com/guarantee).

Furniture

10  
YEAR

Guarantee\*

# FURNITURE

100  
CLOAKROOM

102  
FREESTANDING

104  
FITTED

107  
BATH

110  
CHALFONT

112  
RIVIERA

# CLOAKROOM FURNITURE



Edwardian 560mm Basin & Freestanding Rectangular Cloakroom Vanity Unit

**W:** 560 **D:** 470 **H:** 927

**Matt White:** FC12W + B4  
**Sand:** FC12S + B4  
**Dark Olive:** FC12O + B4  
**Classic Grey:** FC12G + B4  
**Blue:** FC12B + B4



Classic 510mm Basin & Freestanding 500mm Square Cloakroom Vanity Unit

**W:** 510 **D:** 450 **H:** 915

**Matt White:** FC8W + B20  
**Dark Olive:** FC8O + B20  
**Classic Grey:** FC8G + B20  
**Blue:** FC8B + B20



Edwardian Cloakroom Basin & Freestanding Rectangular Cloakroom Vanity Unit

**W:** 512 **D:** 310 **H:** 905

**Matt White:** FC11W + B8  
**Sand:** FC11S + B8  
**Dark Olive:** FC11O + B8  
**Classic Grey:** FC11G + B8  
**Blue:** FC11B + B8



Corner Quattrocast Basin & Freestanding Corner Cloakroom Vanity Unit

**W:** 430 **D:** 430 **H:** 840

**Matt White:** FC7W + FC7BB  
**Classic Grey:** FC7G + FC7BB

Right hand only.  
 Handles are supplied fitted.



For full details on our furniture ranges go to [burlingtonbathrooms.com/guides/furniture](http://burlingtonbathrooms.com/guides/furniture)

\*Please check the product to see the colours available.

Chrome handles included with the furniture. To purchase alternative finishes please use the codes: **Nickel:** A56 NKL **Gold:** A56 GOLD

# FREESTANDING FURNITURE

Furniture Colours\*:



Freestanding 650 Vanity Unit & Classic 650 Basin for Standard Waste & Overflow

**With Doors**

W: 670 D: 580 H: 930

**Matt White:** FF8W + B15  
**Sand:** FF8S + B15  
**Dark Olive:** FF8O + B15  
**Classic Grey:** FF8G + B15  
**Blue:** FF8B + B15

**With Drawers**

W: 670 D: 580 H: 930

**Matt White:** FF9W + B15  
**Classic Grey:** FF9G + B15



Freestanding 1300 Vanity Unit With Doors & Minerva® Worktops with Double Vanity Bowl

**With Doors**

W: 1300 D: 550 H: 850-930

**Matt White:** FC9W  
**Sand:** FC9S  
**Dark Olive:** FC9O  
**Classic Grey:** FC9G  
**Blue:** FC9B

**With Drawers**

W: 1300 D: 550 H: 850-930

**Matt White:** FC10W  
**Classic Grey:** FC10G

Now choose a worktop from the below



**White:** BW12    **Carrara White:** BC12    **Black Granite:** BB12



Freestanding 650 Vanity Unit & Classic 650 Basin for Integrated Waste & Overflow

**With Doors**

W: 670 D: 580 H: 930

**Matt White:** FF8W + B14  
**Sand:** FF8S + B14  
**Dark Olive:** FF8O + B14  
**Classic Grey:** FF8G + B14  
**Blue:** FF8B + B14

**With Drawers**

W: 670 D: 580 H: 930

**Matt White:** FF9W + B14  
**Classic Grey:** FF9G + B14



Freestanding 1340 Curved Vanity Unit With Doors & Minerva® Worktops with Vanity Bowl

**With Doors**

W: 1340 D: 550 H: 850-930

**Matt White:** FC1W  
**Sand:** FC1S  
**Dark Olive:** FC1O  
**Classic Grey:** FC1G  
**Blue:** FC1B

**With Drawers**

W: 1340 D: 550 H: 850-930

**Matt White:** FC4W  
**Sand:** FC4S  
**Dark Olive:** FC4O  
**Classic Grey:** FC4G  
**Blue:** FC4B

Now choose a worktop from the below



**White:** BW13    **Carrara White:** BC13    **Black Granite:** BB13



Freestanding 650 Vanity Unit & Minerva® Worktops with Vanity Bowl

**With Doors**

W: 670 D: 580 H: 850-930

**Matt White:** FF8W  
**Sand:** FF8S  
**Dark Olive:** FF8O  
**Classic Grey:** FF8G  
**Blue:** FF8B

**With Drawers**

W: 670 D: 580 H: 850-930

**Matt White:** FF9W  
**Classic Grey:** FF9G

Now choose a worktop from the below



**White:** BW66    **Carrara White:** BC66    **Black Granite:** BB66



Freestanding 980 Curved Vanity Unit With Doors & Minerva® Worktops with Vanity Bowl

**Left Handed**

W: 980 D: 550 H: 850-930

**Matt White:** FC2W  
**Sand:** FC2S  
**Classic Grey:** FC2G  
**Blue:** FC2B

**Right Handed**

W: 980 D: 550 H: 850-930

**Matt White:** FC3W  
**Sand:** FC3S  
**Dark Olive:** FC3O  
**Classic Grey:** FC3G  
**Blue:** FC3B

Now choose a worktop from the below



**White:** BW98L/R    **Carrara White:** BC98L/R    **Black Granite:** BB98L/R

Chrome handles included with the furniture. To purchase alternative finishes please use the codes: **Nickel:** A56 NKL **Gold:** A56 GOLD

\*Please check the product to see the colours available.

# FITTED FURNITURE

Furniture Colours\*:



## Mirrored Wall Units

**600 Double Door**  
**W: 600 D: 150 H: 750**  
**Matt White: F6MW**  
**Sand: F6MS**  
**Classic Grey: F6MG**

**300 Single Door**  
**W: 300 D: 150 H: 750**  
**Matt White: F3MW**  
**Classic Grey: F3MG**



## Base Units

**Double Door**  
**W: 600 D: 300 H: 850**  
**Classic Grey: F60G**

**Single Door**  
**W: 300 D: 300 H: 850**  
**Matt White: F30W**  
**Classic Grey: F30G**



## Wall Units

**600 Double Door**  
**W: 600 D: 150 H: 750**  
**Matt White: F6WW**  
**Sand: F6WS**  
**Dark Olive: F6WO**  
**Classic Grey: F6WG**  
**Blue: F6WB**

**300 Single Door**  
**W: 300 D: 150 H: 750**  
**Matt White: F3WW**  
**Blue: F3WB**



## 600 Basin Base Unit for Semi-recessed Basin

**Unit**  
**W: 600 D: 510 H: 850**  
**Matt White: F6BW**  
**Sand: F6BS**  
**Dark Olive: F6BO**  
**Classic Grey: F6BG**  
**Blue: F6BB**

**Basin**  
**Code: B12**



## 600 Back to Wall WC Unit with Lever

**Unit**  
**W: 600 D: 300 H: 850**  
**Matt White: W60W**  
**Sand: W60S**  
**Classic Grey: W60G**  
**Blue: W60B**

**Back to Wall Pan**  
**Code: P14**

**Regal Back to Wall Pan**  
**Code: P15**

**Wall Hung Pan**  
**Code: P10**



## 300 Tall Two Door Base Unit

**Matt White: F3TW**  
**Classic Grey: F3TG**

Chrome handles included with the furniture. To purchase alternative finishes please use the codes: **Nickel: A56 NKL** **Gold: A56 GOLD**

\*Please check the product to see the colours available.

# FITTED FURNITURE

Furniture Colours\*:



## 1200 Minerva® Worktops

**Minerva® White**  
Code: BW305

**Minerva® Carrara White**  
Code: BC305

**Minerva® Black Granite**  
Code: BB305

Other worktops available see page 112



## 600 Mirrored Cabinet

**W:** 600 **D:** 152 **H:** 750

**Matt White:** SM6015W  
**Sand:** SM6015S  
**Dark Olive:** SM6015O  
**Classic Grey:** SM6015G  
**Blue:** SM6015B

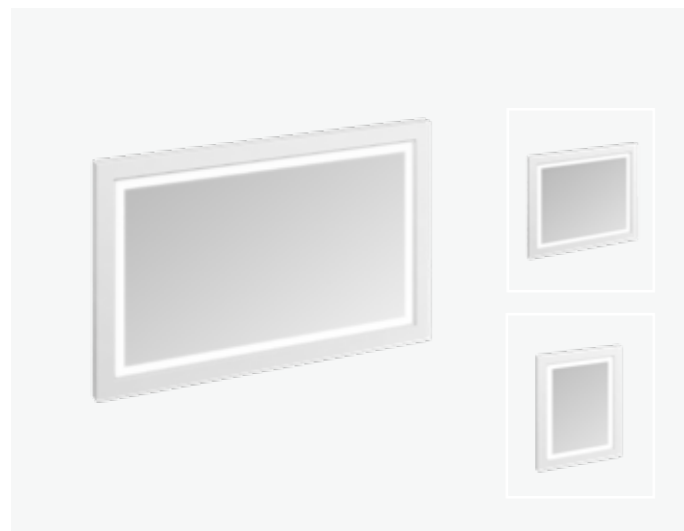

## Framed Mirror with LED Illuminations

**1200 Mirror**  
**W:** 1200 **D:** 40 **H:** 750  
**Matt White:** M12MW  
**Sand:** M12MS  
**Dark Olive:** M12MO  
**Classic Grey:** M12MG  
**Blue:** M12MB

**900 Mirror**  
**W:** 900 **D:** 40 **H:** 750  
**Matt White:** M9MW  
**Classic Grey:** M9MG

**600 Mirror**  
**W:** 600 **D:** 40 **H:** 750  
**Matt White:** M6MW  
**Sand:** M6MS  
**Dark Olive:** M6MO  
**Classic Grey:** M6MG  
**Blue:** M6MB



## Arundel Bath with Panels

**1700 x 700**  
**W:** 700 **D:** 1700 **H:** 595  
**Matt White:** E28 + E24FW + E25EW  
**Sand:** E28 + E24FS + E25ES  
**Classic Grey:** E28 + E24FG + E25EG

**1700 x 750**  
**W:** 750 **D:** 1700 **H:** 595  
**Matt White:** E30 + E24FW + E26EW  
**Sand:** E30 + E24FS + E26ES  
**Dark Olive:** E30 + E24FO + E26EO  
**Classic Grey:** E30 + E24FG + E26EG

Compatible bath grips available see page 125

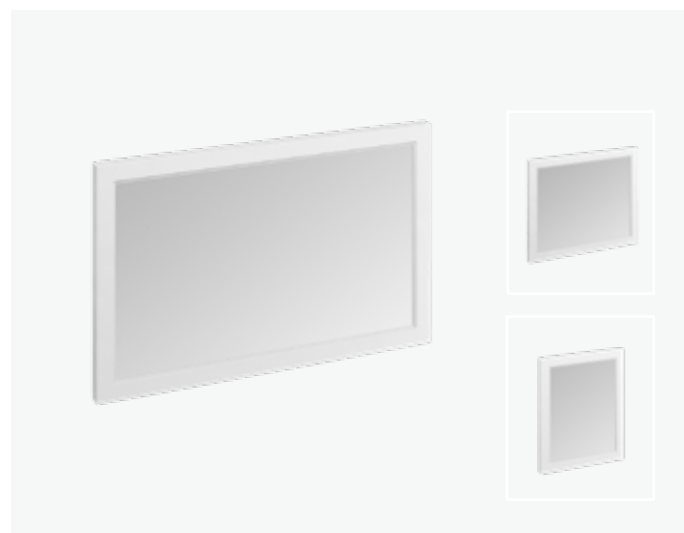

## Framed Mirror

**1200 Mirror**  
**W:** 1200 **D:** 40 **H:** 750  
**Matt White:** M12OW  
**Classic Grey:** M12OG

**900 Mirror**  
**W:** 900 **D:** 40 **H:** 750  
**Matt White:** M9OW  
**Classic Grey:** M9OG

**600 Mirror**  
**W:** 600 **D:** 40 **H:** 750  
**Matt White:** M6OW  
**Classic Grey:** M6OG



## London Bath with Panel

**Back to Wall**  
**W:** 950 **D:** 1800 **H:** 600  
**Matt White:** E23W  
**Sand:** E23S  
**Dark Olive:** E23O  
**Classic Grey:** E23G

\*Please check the product to see the colours available.

## MINERVA WORKTOPS

Minerva worktops offer superior strength with a beautiful finish. Available from stock in either White, Carrara White or Black Granite. Why not choose from our other 11 unique decor options, available to order with longer custom delivery times (4 - 5 weeks) for the ultimate personalised look. Please ask your retailer for details on the price of the 11 additional finishes.



White



Carrara White



Black Granite



Ice Blue



Desert Rock



Fossil



Peak Stone



Nimbus Grey



Amazonia Brown



Ice Crystal



Copper Fleck



Sparkling White



Caramel Crunch



Grey Crystal



Minerva® Care Kit

Code: BCARE



Minerva® Joint Kit

White: MVWH  
Carrara White: MVBG  
Black Granite: MVCA

### Minerva Basins

Minerva basins fit perfectly with your chosen furniture unit. Should you opt for a fitted furniture look, a Minerva worktop can be chosen to fit the length of your furniture units.

#### Tap holes

Minerva® worktops are supplied with an integrated bowl with overflow, and no tap holes. Tap holes are drilled by the installer in the required position and configuration. A template is provided with the Minerva® tops indicating tap hole positions and sizes.

#### Routine Cleaning

Minerva® does not require any specialist cleaning regimes, most dirt will easily wipe off with a damp cloth and soapy water. The work surface should then be rinsed with clean water and wiped dry. Persistent marks can be removed by using a mild abrasive cleaner, but harsh scouring powders should be avoided.

#### Staining

Minerva®, unlike marble and granite, is not porous and will resist most household chemicals including alcohol and cosmetics, however, some chemicals and strong dyes can cause damage and discolouration. If spillage occurs, wipe off immediately and rinse the area thoroughly.

#### Minerva® Care Kit

To restore your Minerva® work top to its original best use the Care Kit to buff out all tiny scratches and scuffs. The kit contains all the sanding / buffing materials and liquids required.

## PAINT YOUR OWN

Should you wish, our Matt White furniture is supplied ready for you to paint, so you can transform your entire bathroom into your individual colour scheme. We've chosen some Farrow & Ball colours as suggestions displayed below. We recommend using a water based primer before an egg shell paint finish for the best effect.



Brinjal

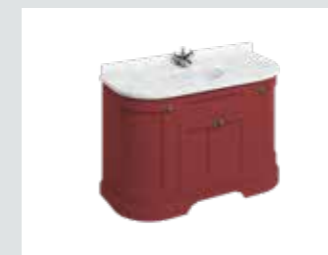

Incarnadine

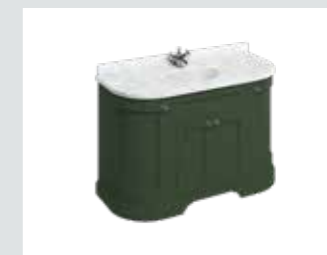

Duck Green

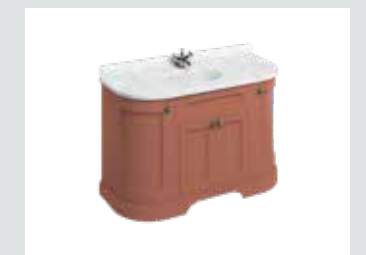

Red Earth



Cook's Blue



Cinder Rose



Oxford Stone



Dayroom Yellow

For full details on our furniture ranges go to [burlingtonbathrooms.com/guides/furniture](http://burlingtonbathrooms.com/guides/furniture)



# CHALFONT

Furniture Colours:



550 Unit with Drawer & Natural Stone  
Small Roll Top Basin

<b>With Matching Legs</b>	<b>Wall Hung</b>
<b>W:</b> 525 <b>D:</b> 458 <b>H:</b> 840	<b>W:</b> 525 <b>D:</b> 458 <b>H:</b> 840
<b>Matt Black:</b> CH55MB + B7E* + CHLEGMB	<b>Matt Black:</b> CH55MB + B7E*
<b>Classic Grey:</b> CH55G + B7E* + CHLEGG	<b>Classic Grey:</b> CH55G + B7E*
<b>Blue:</b> CH55B + B7E* + CHLEGB	<b>Blue:</b> CH55B + B7E*

Also available with small roll top basin with up-stand. See page 90



1000 Unit with Drawer & Natural Stone  
Double Roll Top Basin

<b>With Matching Legs</b>	<b>Wall Hung</b>
<b>W:</b> 525 <b>D:</b> 458 <b>H:</b> 840	<b>W:</b> 525 <b>D:</b> 458 <b>H:</b> 840
<b>Matt Black:</b> CH100MB + B10DE* + CHLEGMB	<b>Matt Black:</b> CH100MB + B10DE*
<b>Classic Grey:</b> CH100G + B10DE* + CHLEGG	<b>Classic Grey:</b> CH100G + B10DE*
<b>Blue:</b> CH100B + B10DE* + CHLEGB	<b>Blue:</b> CH100B + B10DE*



650 Unit with Drawer & Natural Stone  
Medium Roll Top Basin

<b>With Matching Legs</b>	<b>Wall Hung</b>
<b>W:</b> 625 <b>D:</b> 458 <b>H:</b> 840	<b>W:</b> 625 <b>D:</b> 458 <b>H:</b> 840
<b>Matt Black:</b> CH65MB + B8E* + CHLEGMB	<b>Matt Black:</b> CH65MB + B8E*
<b>Classic Grey:</b> CH65G + B8E* + CHLEGG	<b>Classic Grey:</b> CH65G + B8E*
<b>Blue:</b> CH65B + B8E* + CHLEGB	<b>Blue:</b> CH65B + B8E*

Also available with medium roll top basin with up-stand. See page 90



750 Unit with Drawer & Natural Stone  
Large Roll Top Basin

<b>With Matching Legs</b>	<b>Wall Hung</b>
<b>W:</b> 725 <b>D:</b> 458 <b>H:</b> 840	<b>W:</b> 725 <b>D:</b> 458 <b>H:</b> 840
<b>Matt Black:</b> CH75MB + B9E* + CHLEGMB	<b>Matt Black:</b> CH75MB + B9E*
<b>Classic Grey:</b> CH75G + B9E* + CHLEGG	<b>Classic Grey:</b> CH75G + B9E*
<b>Blue:</b> CH75B + B9E* + CHLEGB	<b>Blue:</b> CH75B + B9E*

## ADDITIONAL CHOICES

Our Chalfont furniture range is supplied without legs or handles allowing you to fully customise your furniture to the look you desire. To add these, please select from the options below.

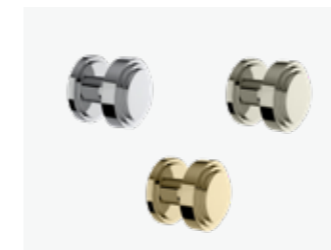

### Handles

Our beautiful matching handles are available in 3 finishes allowing you to match your brassware and furniture unit perfectly. Use the codes below to order. Please note these are sold as singles.

**Chrome:** CHKCHR  
**Nickel:** CHKNKL  
**Gold:** CHKGOLD



### Additional Legs

As well as having legs in the matching furniture colour we also offer 3 additional finishes with a slightly different design which are sold in pairs. If you would like these legs instead please use the codes below:

**Chrome:** CHLEGCHR  
**Nickel:** CHLEGNKL  
**Gold:** CHLEGGOLD



For full details on our Chalfont range go to [burlingtonbathrooms.com/collection/chalfont](http://burlingtonbathrooms.com/collection/chalfont)

\* Supplied undrilled for your preferred choice of 0, 1, 2 or 3 taphole. Tap holes are drilled by the installer in the required position and configuration.

# RIVIERA

Furniture  
Colours:



580 Riviera Unit with Basin

**580 Vanity Unit**

**W:** 580 **D:** 470 **H:** 880

**Matt White:**  
RIVF580W + RIV1\*

**Matt Blue:**  
RIVF580B + RIV1\*

**Matt Pink:**  
RIVF580P + RIV1\*

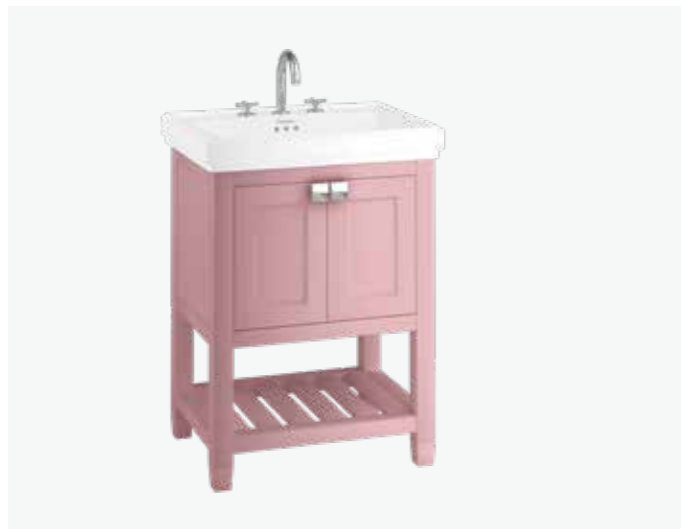

650 Riviera Unit with Basin

**650 Vanity Unit**

**W:** 650 **D:** 470 **H:** 880

**Matt White:**  
RIVF650W + RIV2\*

**Matt Blue:**  
RIVF650B + RIV2\*

**Matt Pink:**  
RIVF650P + RIV2\*

## ADDITIONAL CHOICES

Our Chalfont furniture range is supplied with Chrome handles, we also have Gold and Nickel options allowing you to fully customise your furniture to the look you desire. To add these, please select from the options below.

**Handles**

Please note these are sold as a set of 2.

**Nickel:** RIVF 12  
**Gold:** RIVF 11



For full details on our Riviera range go to  
[burlingtonbathrooms.com/riviera](http://burlingtonbathrooms.com/riviera)



# BATHS

Beautiful freestanding baths in a range of designs crafted with either TSFR (twin skinned fibre re-inforced acrylic) for superior strength or ClearStone for the epitome of luxury. Choose from soaking tubs, elegant roll top baths, single or double-ended or showering baths for flexibility of use.

## BATH FEET

Choose from five leg designs in three finishes on page 123.



Claw



Arc



Classic



Traditional



Classical

## PAINTING YOUR BATH

The exterior can be primed and painted. If you wish to paint yours then please note this is only possible on TSFR baths. You should seek advice from the paint manufacturer for suitable primers and processes.



## GUARANTEES

\*For full details on guarantees please visit [burlingtonbathrooms.com/guarantee](http://burlingtonbathrooms.com/guarantee).

Baths  
**10  
YEAR**  
Guarantee\*

# BATHS

116  
FREESTANDING

122  
SHOWERING

122  
ARCADE

123  
ACCESSORIES



## BALTHAZAR

Double Ended Bath

**L:** 1675 **W:** 761 **H:** 711  
**Stainless Steel:** N25CS

**Weight empty**  
111kg  
**Displaced capacity**  
164L  
**Material**  
Clearstone

**Tap hole options**  
Not suitable for  
rim-mounted taps  
**Overflow**  
Pre-drilled

**Compatible wastes**  
CW3, CW11



## BRINDLEY

Double Ended Bath

**1700 Bath**  
**L:** 1700 **W:** 750 **H:** 620  
**Code:** E5.E12

**Weight empty**  
36kg  
**Displaced capacity**  
180L  
**Material**  
Acrylic

**Tap hole options**  
Not suitable for  
rim-mounted taps  
**Overflow**  
Supplied with  
template, undrilled

**Compatible wastes**  
CW2, W3



## ADMIRAL

Double Ended Bath

**1650 Bath** **1800 Bath**  
**L:** 1640 **W:** 705 **H:** 710 **L:** 1775 **W:** 890 **H:** 750  
**Code:** ET5C **Code:** ET6C

**Weight empty**  
1650 - 48kg  
1800 - 60kg  
**Displaced capacity**  
1650 - 99L  
1800 - 175L  
**Material**  
Acrylic

**Tap hole options**  
Not suitable for  
rim-mounted taps  
**Overflow**  
Pre-drilled

**Compatible wastes**  
CW3, W4, CW6



## LONDON ROUND

Double Ended Bath

**1800 Bath**  
**L:** 1800 **W:** 850 **H:** 640  
**Code:** E18

**Weight empty**  
52kg  
**Displaced capacity**  
200L  
**Material**  
Acrylic

**Tap hole options**  
Not suitable for  
rim-mounted taps  
**Overflow**  
Pre-drilled

**Compatible wastes**  
Pre fitted



## ARUNDEL

Single Ended

**700 Bath** **750 Bath**  
**L: 1700 W: 700 H: 580** **L: 1700 W: 750 H: 580**  
**Code: E28** **Code: E30**

**700 End Panels** **750 End Panels** **Side Panel**  
**W: 700 H: 540** **W: 750 H: 540** **L: 1700 H: 540**  
**700: E25E\*** **750: E26E\*** **Code: E24F\***

Replace \* with either W/S/O/G depending on what colour panels you would like.

<b>Weight empty</b> 700 - 24kg 750 - 25kg	<b>Tap hole options</b> Undrilled <b>Overflow</b> Pre-drilled	<b>Compatible wastes</b> W3 <b>Compatible bathscreens</b> C9, C10
<b>Displaced capacity</b> 700 - 108L 750 - 125L		
<b>Material</b> Acrylic with Cleargreen reinforcement		



## AVANTGARDE

Back to Wall Bath

**1700 Bath**  
**L: 1700 W: 750 H: 630**  
**Code: T12D**

**Feet - Shown With**  
**Code: L2B**

<b>Weight empty</b> 43kg	<b>Tap hole options</b> 0, 1, 2 (supplied with template, undrilled)	<b>Compatible wastes</b> CW2, CW3, W4, CW6, W21
<b>Displaced capacity</b> 158L	<b>Overflow</b> Supplied with template, undrilled	<b>Compatible feet</b> See page 123
<b>Material</b> TSFR Double Acrylic		



## EMPEROR

Slipper Bath

**1500 Bath**  
**L: 1530 W: 725 H: 780**  
**Code: ET13B**

<b>Weight empty</b> 38kg	<b>Tap hole options</b> Not suitable for rim-mounted taps	<b>Compatible wastes</b> CW2, CW3, W4, CW6, W21
<b>Displaced capacity</b> 242L	<b>Overflow</b> Supplied with template, undrilled	
<b>Material</b> Acrylic		



## BATEAU

Double Ended Bath

**1700 Bath**  
**L: 1640 W: 700 H: 720**  
**Code: T10F**

**Feet - Shown With**  
**Code: L2C**

**Note**  
 The Bateau bath comes in a white finish. The exterior can be primed and painted. The photograph shows the bath in Fired Earth Carbon Blue. If you wish to paint yours then please note this is only possible on TSFR baths. You should seek advice from the paint manufacturer for suitable primers and processes.

<b>Weight empty</b> 42kg	<b>Tap hole options</b> Not suitable for rim-mounted taps	<b>Compatible wastes</b> CW3, W4, CW6, W21
<b>Displaced capacity</b> 169L	<b>Overflow</b> Pre-drilled	<b>Compatible feet</b> See page 123
<b>Material</b> TSFR Double Acrylic		



## WINDSOR

Double Ended Bath

### 1500 Bath

L: 1500 W: 750 H: 630

Code: E4

### 1700 Bath

L: 1700 W: 750 H: 620

Code: E3

### Feet - Shown With

Code: L1C

### Weight empty

1500 - 45kg  
1700 - 45kg

### Displaced capacity

1500 - 115L  
1700 - 130L

### Material

TSFR Double  
Acrylic

### Tap hole options

0, 1, 2 (supplied  
with template,  
undrilled)

### Overflow

Supplied with  
template,  
undrilled

### Compatible wastes

CW2, CW3, W4,  
W21

### Compatible feet

See page 123



## HAREWOOD

Slipper Bath

### 1700 Bath

L: 1690 W: 730 H: 770

Code: E1

### Feet - Shown With

Code: E11 CHR

### Weight empty

48kg

### Displaced capacity

125L

### Material

TSFR Double  
Acrylic

### Tap hole options

0, 1, 2 (supplied  
with template,  
undrilled)

### Overflow

Supplied with  
template, undrilled

### Compatible wastes

CW2, CW3, W4,  
W21

### Compatible feet

See page 123



## BUCKINGHAM

Slipper Bath

### 1500 Bath

L: 1530 W: 740 H: 620

Code: E6

### Feet - Shown With

Code: L2W

### Weight empty

39kg

### Displaced capacity

85L

### Material

TSFR Double  
Acrylic

### Tap hole options

0, 1, 2 (supplied  
with template,  
undrilled)

### Overflow

Supplied with  
template, undrilled

### Compatible wastes

CW2, CW3, W4,  
W21

### Compatible feet

See page 123



## BLENHEIM

Single Ended Bath

### 1700 Bath

L: 1690 W: 750 H: 640

Code: E2

### Feet - Shown With

Code: E10 CHR

### Weight empty

45kg

### Displaced capacity

115L

### Material

TSFR Double  
Acrylic

### Tap hole options

0, 1, 2 (supplied  
with template,  
undrilled)

### Overflow

Supplied with  
template,  
undrilled

### Compatible wastes

CW2, CW3, W4,  
W21

### Compatible feet

See page 123



## HAMPTON

Showering Bath

### 1500 Bath

L: 1500 W: 750 H: 630

Left Handed: E20  
Right Handed: E21

### 1700 Bath

L: 1700 W: 750 H: 620

Left Handed: E13  
Right Handed: E14

### Feet - Shown With

Code: L3C

### Weight empty

1500 - 37kg  
1700 - 46kg

### Displaced capacity

1500 - 105L  
1700 - 138L

### Material

TSFR double acrylic skin with solid core

### Tap hole options

0, 1, 2 (supplied with template, undrilled)

### Overflow

Supplied with template, undrilled

### Compatible wastes

W4

### Compatible bathscreens

C9, C10

### Compatible feet

See page 123

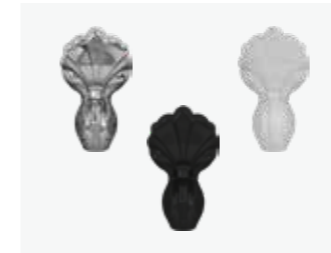

Claw Feet

Chrome: L1C  
White: L1W  
Black: L1B



Arc Feet

Chrome: L2C  
White: L2W  
Black: L2B

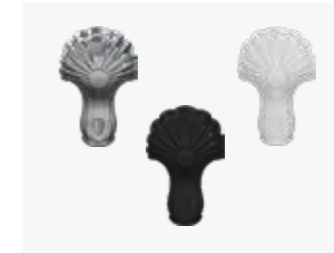

Classic Feet

Chrome: L3C  
White: L3W  
Black: L3B

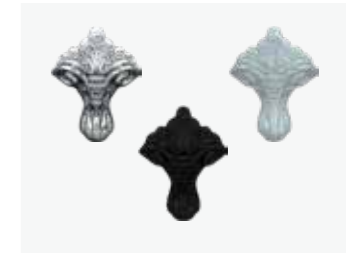

Traditional Feet

Chrome: E11 CHR  
White: E11 WHI  
Black: E11 BLA

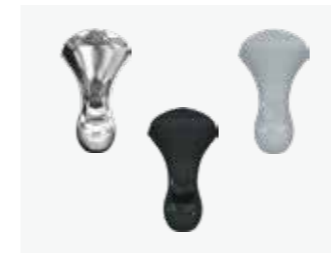

Classical Feet

Chrome: E10 CHR  
White: E10 WHI  
Black: E10 BLA



Stand pipes including horizontal support bar

Chrome: W7  
Gold: W7 GOLD



Decorative shrouds

Chrome: W6  
Nickel: W6 NKL  
Gold: W6 GOLD

These are for use with baths where fittings are not rim or wall-mounted. These can be used with deck-mounted taps (excluding Stafford).

These are for use with baths with rim-mounted fittings and can be used with deck-mounted taps. Decorative only.



## ARCADE - ALBANY

Double Ended Bath

### 1700 Bath

L: 1690 W: 800 H: 570

Code: ARC21

Weight empty  
132kg

Displaced capacity  
256L

Material  
Natural Stone

### Tap hole options

Not suitable for rim-mounted taps

### Overflow

Integrated overflow (excluded the bath waste)

### Compatible wastes

CW1, CW3



Single bathscreen

W: 850 H: 1450

Code: C9



Bathscreen with access panel

W: 850 H: 1450

Code: C10

# BRASSWARE

Burlington brassware can be customised with a choice of 4 tap heads; Claremont, Birkenhead, Anglesey and Kensington.

We supply every tap with two Neoperl devices: A flow straightener, which is for use with low water pressures and an aerator, which is for use with high water pressures.

## KEY FEATURES

Burlington brassware products have a range of key features across basin and bath taps, shown below.



### Swivelling Spouts

All our bath fillers and bath shower mixer spouts swivel - so you don't have the spout in your way when you shower.



### Angled Mixers

All our bath shower mixers are available in an 'angled' version.

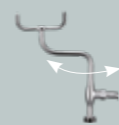

### S Adjuster

The S adjuster allows the telephone handset to be positioned over the bath. The bath shower mixer can be installed with or without the 'S adjuster'.

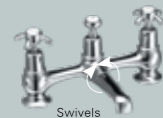

### Bridge Mixers

Our bridge basin mixer has a swivelling spout and allows you to have mixed hot & cold water, whilst using a two taphole configuration.



Normal



Burlington

### Spouts

Normal: The underside of a bath spout of a normal, traditional bath tap.  
Burlington: The underside of a Burlington bath tap with a Neoperl aerator.

## STYLE OPTIONS

Choose from a wide range of tap head options in finishes of either Chrome, Gold or Nickel and choose from a range of indices in White or Black.



Gold



Nickel



Claremont



Anglesey



Birkenhead



Kensington

## REGENT

Our regent base can be used on all one, two and three tap hole taps (excluding Chelsea, Stafford and CL45-QT) offering an extra 30mm of height than the standard tap base and a further 30mm away from the wall when wall-mounted.

For the full range please visit the website.



Standard Regent

## WATER PRESSURE

Our taps are designed to deliver the following maximum flows of water, regardless of the incoming water pressure:

Basin taps: 13L per minute

Bath tap: 14L per minute

Bath shower mixer: 22L per minute



### Normal tap

Water flow in a normal traditional tap.



### Low pressure

Low pressure water flow with a Burlington tap using a flow straightener.



### High pressure

High pressure water flow with a Burlington tap using an aerator.

## GUARANTEES

\*For full details on guarantees please visit [burlingtonbathrooms.com/guarantee](http://burlingtonbathrooms.com/guarantee).

Brassware

15  
YEAR

Guarantee\*

126  
TRADITIONAL

128  
THERMOSTATIC

128  
STAFFORD

129  
CHELSEA

130  
ARCADE

132  
RIVIERA

134  
WASTES



## TRADITIONAL BASIN TAPS



Basin mixer with high central indice with click-clack waste

**White:** CL6-QT  
**Black:** CL6-QT BLA  
**Gold:** CL6-QT GOLD  
**Nickel:** CL6-QT NKL



Basin mixer with high central indice with pop up waste

**White:** CL4-QT  
**Black:** CL4-QT BLA  
**Gold:** CL4-QT GOLD  
**Nickel:** CL4-QT NKL



Basin mixer with high central indice with plug & chain waste

**White:** CL5-QT  
**Black:** CL5-QT BLA



Mono basin Mixer

**White:** CL45-QT  
**Black:** CL45-QT BLA



Bidet mixer with high central indice with plug & chain waste

**White:** CL13-QT  
**Black:** CL13-QT BLA



Basin tap 3"

**White:** CL1-QT  
**Black:** CL1-QT BLA  
**Gold:** CL1-QT GOLD  
**Nickel:** CL1-QT NKL



Basin tap 5"

**White:** CL2-QT  
**Black:** CL2-QT BLA  
**Gold:** CL2-QT GOLD  
**Nickel:** CL2-QT NKL



Two tap hole bridge mixer with swivelling spout with plug & chain waste

**White:** CL10-QT  
**Black:** CL10-QT BLA



Two tap hole arch mixer with curved spout (200 centre)

**White:** CL27-QT  
**Black:** CL27-QT BLA



Two tap hole arch mixer with curved spout (230 centre)

**White:** CL28-QT  
**Black:** CL28-QT BLA



Three tap hole mixer with pop up waste

**White:** CL12-QT  
**Black:** CL12-QT BLA  
**Gold:** CL12-QT GOLD  
**Nickel:** CL12-QT NKL

### Regent Options

Our regent base which can be used on all one, two and three tap hole taps (excluding Chelsea, Stafford and CL45-QT) offering an extra 30mm of height than the standard tap base and a further 30mm away from the wall when wall-mounted.

For the full range please visit the website.



## TRADITIONAL BATH TAPS



Bath shower mixer with 'S' adjuster deck-mounted

**White:** CL15-QT  
**Black:** CL15-QT BLA  
**Gold:** CL15-QT GOLD  
**Nickel:** CL15-QT NKL



Angled bath shower mixer with 'S' adjuster deck-mounted

**White:** CL19-QT  
**Black:** CL19-QT BLA



Bath filler deck-mounted

**White:** CL23-QT  
**Black:** CL23-QT BLA



Bath taps deck-mounted

**White:** CL3-QT  
**Black:** CL3-QT BLA



Bath shower mixer with 'S' adjuster wall-mounted

**White:** CL17-QT  
**Black:** CL17-QT BLA  
**Gold:** CL17-QT GOLD  
**Nickel:** CL17-QT NKL



Angled bath shower mixer with 'S' adjuster wall-mounted

**White:** CL21-QT  
**Black:** CL21-QT BLA

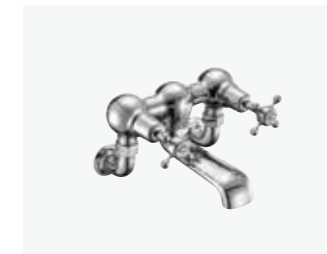

Bath filler wall-mounted

**White:** CL24-QT  
**Black:** CL24-QT BLA

### Full Turn Options

To order your taps with full turn handles please remove QT from the end of the code.

Please note: CL45-QT, Gold, Nickel and Kensington taps are only available as quarter-turn valves.



Traditional screw-down

Quarter turn

## TAP HEAD OPTIONS

Choose from a wide range of tap head options in finishes of either Chrome, Gold or Nickel and choose from a range of indices in White and Black.

All our tap heads are available in Chrome and come with White indices as standard.

**Claremont:** The Claremont tap head is also available in Gold and Nickel with White indices. If ordered in Chrome finish it can be paired with Black indices.

**Kensington:** The Kensington tap head is available in Chrome with Black indices.

**Birkenhead:** The Birkenhead tap head is available in Chrome and can be paired with Black indices.

**Anglesey:** The Anglesey tap head is available in Chrome and can be paired with Black indices.

When ordering your **tap style** add the correct code to the start of the tap code:  
 Claremont add CL  
 Anglesey add AN  
 Birkenhead add BI  
 Kensington add KE

To select an **alternative finish** add the below to the end of the code:  
 Black add BLA  
 Gold add GOLD  
 Nickel add NKL

Examples:  
 CL6 GOLD, CL6 NKL or  
 CL6 BLA.

**Note:** Gold and Nickel brassware cannot be paired with Black.

Visit our website to view all the collections.



For full details on our Brassware ranges go to [burlingtonbathrooms.com/guides/brassware](http://burlingtonbathrooms.com/guides/brassware)

## THERMOSTATIC

Match your basin, bath and shower with the convenience and safety of thermostatic controls for your bathroom.



Three tap hole basin mixer with pop up waste

**White:** CL29  
**Black:** CL29 BLA



Bath shower mixer deck-mounted with 'S' adjuster

**White:** T2DB  
**Black:** T2DB BLA



Thermostatic two outlet twin control bath shower mixer valve

**White Ceramic**

Deck: BT2DS+V16  
Deck: BT2DS+V17  
Deck: BT2DS+V60  
Wall: BT2WS+V16  
Wall: BT2WS+V17  
Wall: BT2WS+V60

**Black Ceramic**

Deck: BT2DS BLA+V16  
Deck: BT2DS BLA+V17  
Deck: BT2DS BLA+V60  
Wall: BT2WS BLA+V16  
Wall: BT2WS BLA+V17  
Wall: BT2WS BLA+V60

**Safety**

We use Vernet wax capsules throughout our thermostatic brassware and showering valves, meaning temperature when in use will not vary by more than + 1 degrees.

## CHELSEA



Curved basin mixer without waste

**White:** CH21  
**Black:** CH21 BLA



Curved basin mixer with pop up waste

**White:** CH22  
**Black:** CH22 BLA



Curved bidet mixer with pop up waste

**White:** CH23  
**Black:** CH23 BLA



Straight basin mixer without waste

**White:** CH19  
**Black:** CH19 BLA



Straight basin mixer with pop up waste

**White:** CH20  
**Black:** CH20 BLA

**Unique Aesthetics**

The Chelsea brassware range comes with its own unique, bespoke tap heads and are not available as Claremont, Anglesey or Birkenhead. The lever can be changed from White to Black. Chelsea's range also comes with the choice of curved or straight spout.

## STAFFORD

The Stafford collection cannot be paired with any other tap head options and is only available in quarter turn.



Stafford bath pillar taps  
**Code:** STA13-QT



Stafford long nose basin pillar taps  
**Code:** STA12-QT



Stafford mono basin mixer with pop up waste  
**Code:** STA11-QT

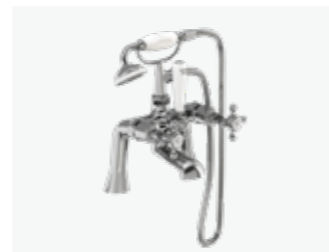

Stafford bath shower mixer deck-mounted  
**Code:** STA14-QT



Curved tall basin mixer without waste  
**White:** CHE2  
**Black:** CHE2 BLA



Straight tall basin mixer without waste  
**White:** CHE1  
**Black:** CHE1 BLA



For full details on our Brassware ranges go to [burlingtonbathrooms.com/guides/brassware](http://burlingtonbathrooms.com/guides/brassware)

# ARCADE

## BASIN BRASSWARE



Chrome dual lever basin mixer without pop up waste

**Crosshead:** ACL14C  
**Chrome Lever:** ABBL14C  
**White Lever:** AWL14C



Chrome single lever basin mixer without pop up waste

**Crosshead:** ACL12C  
**Chrome Lever:** ABBL12C  
**White Lever:** AWL12C

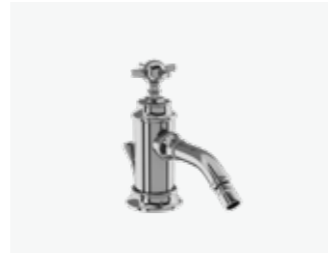

Chrome single lever bidet mixer with pop up waste

**Crosshead:** ACL13C  
**Chrome Lever:** ABBL13C  
**White Lever:** AWL13C

## BASIN BRASSWARE



Nickel single lever basin mixer without pop up waste

**Crosshead:** ACL12N  
**White Lever:** AWL12N  
**Black Lever:** ABL12N



Nickel single lever bidet mixer with pop up waste

**Crosshead:** ACL13N  
**White Lever:** AWL13N  
**Black Lever:** ABL13N

## BATH BRASSWARE

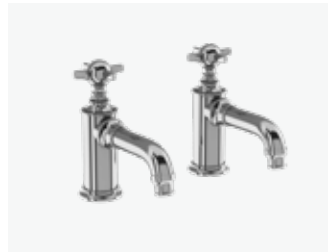

Chrome basin pillar taps

**Crosshead:** ACL17C  
**Chrome Lever:** ABBL17C  
**White Lever:** AWL17C



Chrome cloakroom basin pillar taps

**Crosshead:** ACL36C  
**Chrome Lever:** ABBL36C  
**White Lever:** AWL36C



Chrome single lever bath shower filler

**Chrome Lever:** ABBL20C  
**White Lever:** AWL20C

**Flow Rates**

All Arcade taps are supplied with aerator's and flow straightener's. Flow rates are between 0.2 & 5 bar.

**Flow straightener**  
This is for use with low water pressure.

**Aerator**  
This is for use with high pressure.

## BATH BRASSWARE



Nickel basin pillar taps

**Crosshead:** ACL17N  
**White Lever:** AWL17N  
**Black Lever:** ABL17N



Nickel three hole basin mixer deck-mounted without pop up waste

**Crosshead:** ACL15N  
**White Lever:** AWL15N  
**Black Lever:** ABL15N



Nickel three hole basin mixer wall-mounted without pop up waste

**Crosshead:** ACL16N  
**White Lever:** AWL16N  
**Black Lever:** ABL16N



Nickel bath shower mixer deck-mounted

**Crosshead:** ACL18N  
**White Lever:** AWL18N  
**Black Lever:** ABL18N



Nickel bath shower mixer wall-mounted

**Crosshead:** ACL19N  
**White Lever:** AWL19N  
**Black Lever:** ABL19N



Nickel single lever bath shower filler

**Nickel Lever:** ABBL20N  
**White Lever:** AWL20N

**Lever Options**

Every piece of Arcade brassware, whether you choose from the elegant lustre of nickel or the high shine of chrome, is available with either crosshead tap heads or levers in corresponding nickel or chrome, serene White ceramic or intense Black ceramic, each with a timeless quality.

**Crosshead**      **Brass Lever**

**White Ceramic Lever**      **Matt Black Ceramic Lever**

For full details on our Brassware ranges go to [burlingtonbathrooms.com/guides/brassware](http://burlingtonbathrooms.com/guides/brassware)

# RIVIERA

For the full Riviera range visit  
[burlingtonbathrooms.com/riviera](http://burlingtonbathrooms.com/riviera)

## BASIN BRASSWARE



Basin mixer  
**Chrome:** RIV8 CHR  
**Gold:** RIV8 GOLD



Basin pillar taps  
**Chrome:** RIV7 CHR  
**Gold:** RIV7 GOLD



Three tap hole mixer  
**Chrome:** RIV6 CHR  
**Gold:** RIV6 GOLD



Three hole basin mixer wall-mounted  
**Chrome:** RS CHR  
**Gold:** RS GOLD

## BATH BRASSWARE



Deck-mounted panel valves  
**Chrome:** RIV34 CHR  
**Gold:** RIV34 GOLD



Three tap hole bath mixer  
**Chrome:** RIV32 CHR  
**Gold:** RIV32 GOLD



Four tap hole bath mixer  
**Chrome:** RIV33 CHR  
**Gold:** RIV33 GOLD

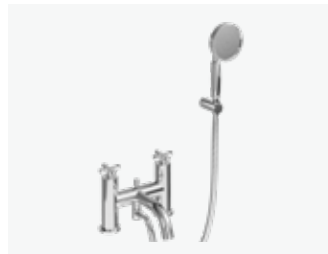

Bath shower mixer with handset and hose  
**Chrome:** RIV4 CHR  
**Gold:** RIV4 GOLD



Bath legs for bath shower mixer  
**Chrome:** RIV15 CHR  
**Gold:** RIV15 GOLD



Overflow bath filler with click-clack waste  
**Chrome:** RIV36 CHR  
**Gold:** RIV36 GOLD



Overflow bath filler extension kit  
**Code:** RIV38



For full details on our Brassware ranges go to [burlingtonbathrooms.com/guides/brassware](http://burlingtonbathrooms.com/guides/brassware)

# WASTES



Shallow p trap  
**Chrome:** CW3  
**Nickel:** CW3 NKL  
**Gold:** CW3 GOLD



Bath overflow plug & chain  
**Chrome:** W3  
**Gold:** W3 GOLD



Black/Medici bath overflow plug & chain  
**Black:** W3 BLA



P trap connection pipe  
**Chrome:** W21  
**Nickel:** W21 NKL  
**Gold:** W21 GOLD



Click clack (push button) basin waste  
**Chrome:** W11  
**Nickel:** W11 NKL  
**Gold:** W11 GOLD



Basin plug & chain, slotted  
**Chrome:** W1  
**Nickel:** W1 NKL  
**Gold:** W1 GOLD



Basin tap shut off valves (hot/cold)  
**Code:** W28



Black/Medici basin tap shut off valves (hot/cold)  
**Black:** W28 BLA



Overflow filler for single and double ended baths  
**Single:** W15



Black/Medici overflow filler for single and double ended baths  
**Black Single:** W15 BLA



Click clack bath waste (slotted) with chrome cover  
**Code:** CW1



Click clack bath waste (unslotted) with chrome cover  
**Code:** CW2



Bidet trap  
**Code:** W27



Cistern tank on/off valve  
**Chrome:** W25  
**Gold:** W25 GOLD



Black/Medici cistern tank on/off valve  
**Black:** W25 BLA



Angled connector for telephone handset  
**Chrome:** V62



Special bath waste without a pre-drilled overflow hole  
**Code:** CW11



Exposed bath overflow, click clack waste  
**Code:** CW6



Exposed bath overflow, pug & chain  
**Chrome:** W4  
**Nickel:** W4 NKL  
**Gold:** W4 GOLD



Black/Medici exposed bath overflow, pug & chain  
**Black:** W4 BLA



Flat bottom bottle trap  
**Code:** W13



Traditional bottle trap  
**Chrome:** W14  
**Nickel:** W14 NKL  
**Gold:** W14 GOLD



Flip top basin waste, slotted  
**Chrome:** W18  
**Nickel:** W18 NKL  
**Gold:** W18 GOLD



Tap hole stopper, chrome  
**Code:** A49 CHR



# SHOWERING

Our range of showers provide extensive options to create a perfect showering solution. Whether you prefer showering over a bath or within an enclosure, our range of thermostatic valves offer safe and controllable showering for the entire family. Partner with a wide range of enclosure styles with corresponding trays.

## KEY FEATURES

All our showers come as standard with the below key features.



### One Way Water

Our non-return valves ensure the flow of water in only one direction, ensuring heating efficiency, preventing siphonage of contaminated water and keeping your shower cartridge in excellent condition for longer.



### Airburst Shower Heads

By combining air and water, the pressure inside the shower head is increased. The power of a traditional shower head with up to 33% water saved.



### Thermostatic Showering

Within the valve there is an automatic adjuster which maintains temperature by adjusting the flow of each supply. This is useful in guarding against the possibility of scalding. If for instance, someone flushes a WC whilst you are showering, the flow of hot water will immediately be closed down to compensate for the reduced cold water flow.

## STYLE OPTIONS

Our showers are available with concealed or exposed valves.



### Concealed

A concealed shower valve creates a clean finish as the valve is hidden behind the wall.



### Exposed

An exposed shower valve is fitted onto the wall and has a more traditional feel.

## GUARANTEES

\*The lifetime guarantee is subject to online registration and represents the perceived lifetime of the product which is 25 years. For full details on guarantees please visit [burlingtonbathrooms.com/guarantee](http://burlingtonbathrooms.com/guarantee).

Showering

**15  
YEAR**

Guarantee\*

Enclosures

**LIFETIME**

Guarantee\*

# SHOWERING

138  
TRENT

139  
AVON

140  
EDEN

140  
SEVERN

141  
TAY

142  
STOUR

143  
ACCESSORIES

144  
RIVIERA

146  
ENCLOSURES

# TRENT

## Concealed Thermostatic Showers

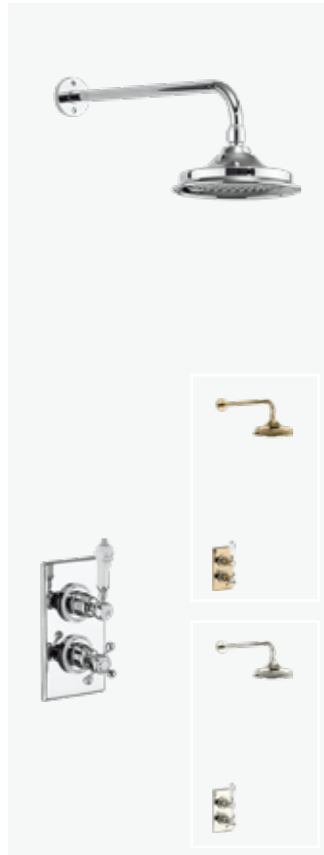

Thermostatic single function brass valve with independent temperature control

Traditional brass faceplate and Claremont handle with ceramic lever

390mm adjustable shower arm

6", 9" or 12" AirBurst shower head  
(9" and 12" only for Nickel, 9" only for Gold)

### White Ceramic

Chrome: TF1S+V16  
Chrome: TF1S+V17  
Chrome: TF1S+V60  
Nickel: TF1S NKL+V60  
Gold: TF1S GOLD+V17

### Black Ceramic

TF1S BLA+V16  
TF1S BLA+V17  
TF1S BLA+V60



Thermostatic dual function brass valve with independent flow diverter and temperature control

Traditional brass faceplate and Claremont handle with ceramic lever

Wall outlet & 1500mm shower hose

Adjustable wall bracket and handset with ceramic handle

390mm adjustable shower arm

6", 9" or 12" AirBurst shower head  
(9" and 12" only for Nickel, 9" only for Gold)

### White Ceramic

Chrome: TF2S+V16  
Chrome: TF2S+V17  
Chrome: TF2S+V60  
Nickel: TF2S NKL+V60  
Gold: TF2S GOLD+V17

### Black Ceramic

TF2S BLA+V16  
TF2S BLA+V17  
TF2S BLA+V60



Thermostatic single function brass valve with independent temperature control

Traditional brass faceplate and Claremont handle with ceramic lever

Slide rail including the elbow, hose and handset with ceramic handle

### White Ceramic

TF1H

### Black Ceramic

TF1H BLA

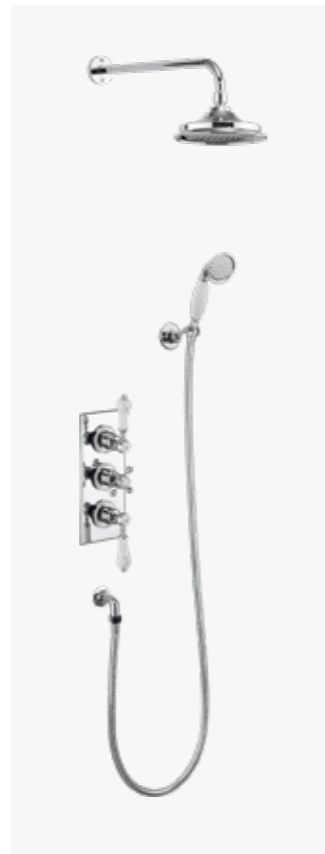

Thermostatic dual function brass valve with two independent on/off controls and central temperature control

Traditional brass faceplate and Claremont handle with ceramic lever

Wall outlet & 1500mm shower hose

Adjustable wall bracket and handset with ceramic handle

390mm adjustable shower arm

6", 9" or 12" AirBurst shower head

### White Ceramic

TF3S+V16  
TF3S+V17  
TF3S+V60

### Black Ceramic

TF3S BLA+V16  
TF3S BLA+V17  
TF3S BLA+V60

# AVON

## Exposed Thermostatic Showers

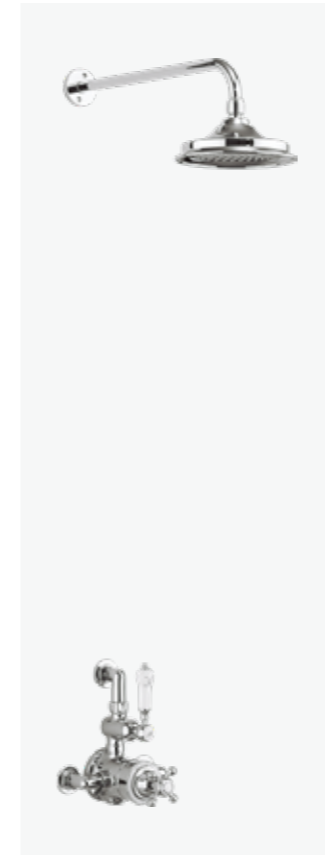

Thermostatic single function brass valve with independent temperature control

Traditional brass body and Claremont handle with ceramic lever

390mm adjustable shower arm

6", 9" or 12" AirBurst shower head

### White Ceramic

AF1S+V16  
AF1S+V17  
AF1S+V60



Thermostatic dual function brass valve with two independent on/off controls & central temperature control

Traditional brass body and Claremont handle & ceramic lever

Adjustable wall bracket, 1500mm shower hose and handset with ceramic handle

18 diameter vertical shower riser

355mm adjustable swivel shower arm

6", 9" or 12" AirBurst shower head  
(9" and 12" only for Nickel, 9" only for Gold)

### White Ceramic

Chrome: BAF3S+V16  
Chrome: BAF3S+V17  
Chrome: BAF3S+V60  
Nickel: BAF3S NKL+V60  
Gold: BAF3S GOLD+V17

### Black Ceramic

BAF3S BLA+V16  
BAF3S BLA+V17  
BAF3S BLA+V60

## ADDITIONAL CHOICES



Shower valve handle options - Anglesey single valve handle

**White:** V2  
**Black:** V2 BLA



Shower valve handle options - Birkenhead single valve handle

**White:** V3  
**Black:** V3 BLA

### Shower Head Height

The standard riser pipe (V21) has a length of 856mm.

To increase the height of your shower head use the extended riser (V22) which has a length of 1814mm increasing the height by 958mm.

To order the extended riser simply add .EXT to the product code. For example BSF1S changes to BSF1S.EXT

# EDEN

## Exposed Thermostatic Showers

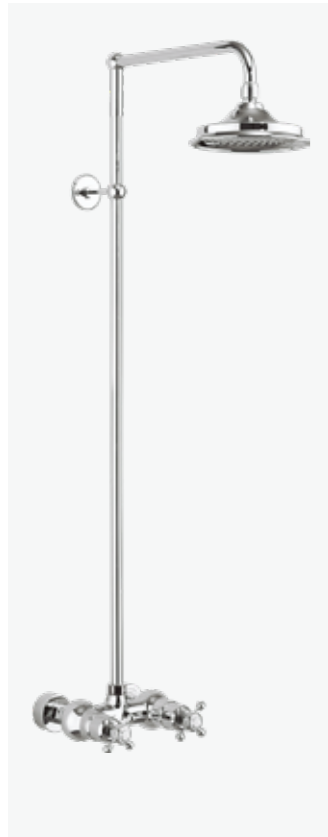

Thermostatic single outlet twin control valve with independent on / off flow and temperature control

Traditional brass body and Claremont handle with ceramic indices

18 diameter vertical brass shower riser

355mm adjustable swivel shower arm

6", 9" or 12" AirBurst shower head

### White Ceramic

BEF1S+V16  
BEF1S+V17  
BEF1S+V60

### Black Ceramic

BEF1S BLA+V16  
BEF1S BLA+V17  
BEF1S BLA+V60

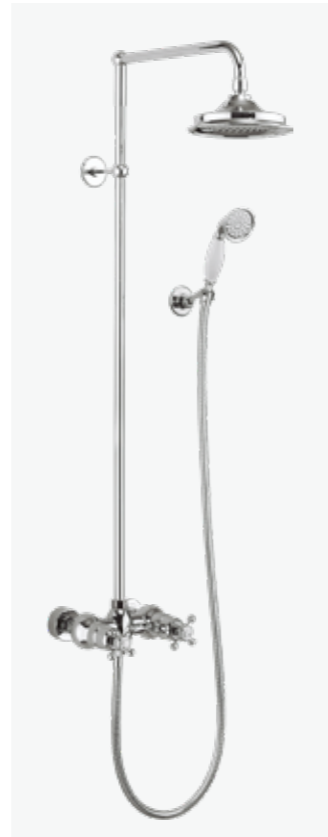

Thermostatic two outlet twin control valve with independent flow diverter and temperature control

Traditional brass body and Claremont handle with ceramic indices

Adjustable wall bracket, 1500mm shower hose and handset with ceramic handle

18 diameter vertical shower riser

390mm adjustable shower arm

6", 9" or 12" AirBurst shower head

### White Ceramic

BEF2S+V16  
BEF2S+V17  
BEF2S+V60

### Black Ceramic

BEF2S BLA+V16  
BEF2S BLA+V17  
BEF2S BLA+V60

# TAY

## Bath Shower Thermostatic Showers



Thermostatic two outlet twin control bath shower mixer valve with independent flow diverter and temperature controls

Traditional brass body and Claremont handles, with ceramic indices

Brass bath spout with swivel function

Available deck or wall-mounted

S connector and bracket, 1500mm shower hose and handset with ceramic handle

### White Ceramic

Deck: T2DB  
Wall: T2WB

### Black Ceramic

Deck: T2DB BLA  
Wall: T2WB BLA



Thermostatic two outlet twin control bath shower mixer valve with independent flow diverter and temperature controls

Traditional brass body and Claremont handles, with ceramic indices

Brass bath spout with swivel function

Available deck or wall-mounted

18 diameter vertical shower riser

355mm adjustable swivel shower arm

6", 9" or 12" AirBurst shower head

### White Ceramic

Deck: BT2DS+V16  
Deck: BT2DS+V17  
Deck: BT2DS+V60  
Wall: BT2WS+V16  
Wall: BT2WS+V17  
Wall: BT2WS+V60

### Black Ceramic

Deck: BT2DS BLA+V16  
Deck: BT2DS BLA+V17  
Deck: BT2DS BLA+V60  
Wall: BT2WS BLA+V16  
Wall: BT2WS BLA+V17  
Wall: BT2WS BLA+V60

# SEVERN

## Concealed Thermostatic Showers

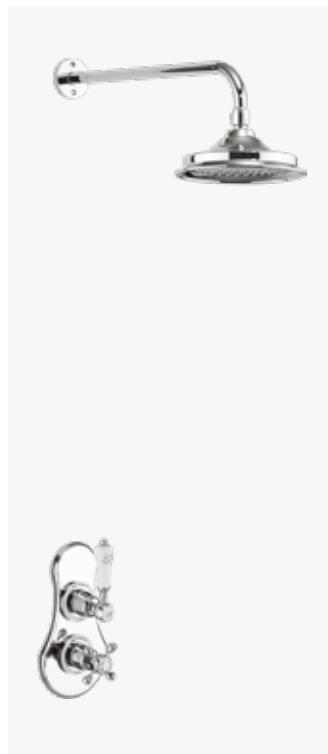

Thermostatic single function brass valve with independent temperature control

Traditional brass faceplate and Claremont handle with ceramic lever

390mm adjustable shower arm

6", 9" or 12" AirBurst shower head

### White Ceramic

VF1S+V16  
VF1S+V17  
VF1S+V60

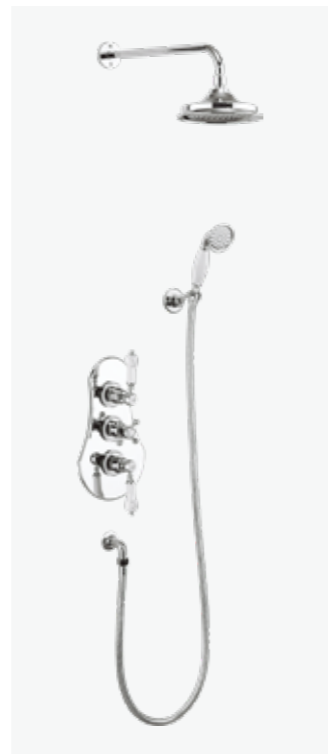

Thermostatic dual function brass valve with two independent on / off controls and central temperature control

Traditional brass faceplate and Claremont handle with ceramic lever

Wall outlet & 1500mm shower hose

Adjustable wall bracket and handset with ceramic handle

390mm adjustable shower arm

6", 9" or 12" AirBurst shower head

### White Ceramic

VF3S+V16  
VF3S+V17  
VF3S+V60

# ADDITIONAL CHOICES



Shower valve handle options - Anglesey single valve handle

**White:** V2  
**Black:** V2 BLA



Shower valve handle options - Birkenhead single valve handle

**White:** V3  
**Black:** V3 BLA

### Shower Head Height

The standard riser pipe (V21) has a length of 856mm.  
To increase the height of your shower head use the extended riser (V22) which has a length of 1814mm increasing the height by 958mm.  
To order the extended riser simply add .EXT to the product code.  
For example BSF1S changes to BSF1S.EXT



# STOUR

## Exposed Thermostatic Showers

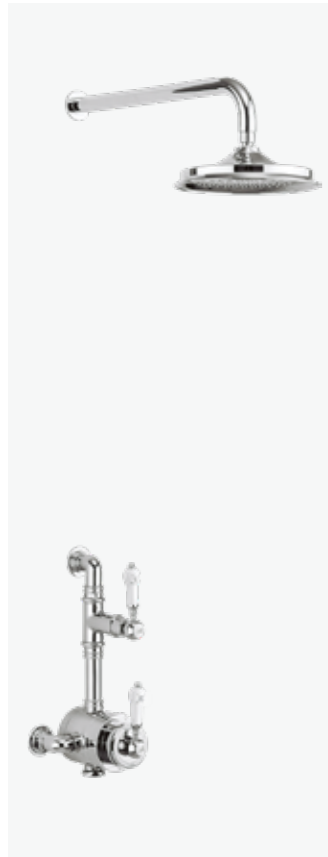

Thermostatic single function brass valve with independent temperature control  
 Traditional brass body and Claremont handle with ceramic lever  
 6", 9" or 12" AirBurst shower head

**White Ceramic**  
 BF1S+V16  
 BF1S+V17  
 BF1S+V60



Thermostatic single function brass valve with independent temperature control  
 Traditional brass body and Claremont handle with ceramic lever  
 28 diameter vertical shower riser  
 450mm adjustable fixed shower arm  
 Soap basket  
 6", 9" or 12" AirBurst shower head

**White Ceramic**  
 BF2S+V16  
 BF2S+V17  
 BF2S+V60

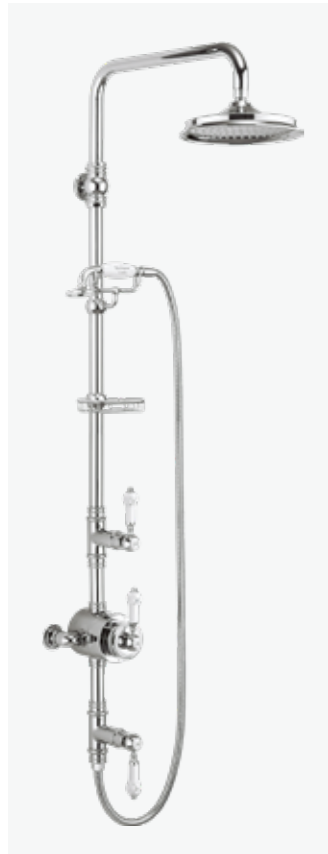

Thermostatic dual function brass valve with two independent on / off controls and central temperature control  
 Traditional brass body, Claremont handle with ceramic lever  
 Fixed cradle, 1500mm shower hose and handset with ceramic handle  
 28 diameter vertical shower riser  
 450mm adjustable fixed shower arm  
 Soap basket  
 6", 9" or 12" AirBurst shower head

**White Ceramic**  
 BF3S+V16  
 BF3S+V17  
 BF3S+V60

**Shower Head Height**  
 The standard riser pipe (V21) has a length of 856mm.  
 To increase the height of your shower head use the extended riser (V22) which has a length of 1814mm increasing the height by 958mm.  
 To order the extended riser simply add .EXT to the product code.  
 For example BSF1S changes to BSF1S.EXT

# ACCESSORIES



Soap Basket  
**Chrome:** V23  
**Nickel:** V23 NKL



Cradle  
**Chrome:** V24



Slide Rail  
**Chrome:** V33  
**Black:** V33 BLA  
**Nickel:** V33 NKL



Spout Fitting  
**Chrome:** V32  
**Nickel:** V32 NKL



Extended Vertical Riser Rail  
**Chrome:** V22  
**Nickel:** V22 NKL  
**Gold:** V22 GOLD



Ceramic Handset, Hose & Diverter  
**Chrome:** V27  
**Nickel:** V27 NKL  
**Black:** V27 BLA



Shower valve handle options - Anglesey single valve handle  
**White:** V2  
**Black:** V2 BLA



Shower valve handle options - Birkenhead single valve handle  
**White:** V3  
**Black:** V3 BLA



# RIVIERA

For the full Riviera range visit  
[burlingtonbathrooms.com/riviera](http://burlingtonbathrooms.com/riviera)

Create your perfect showering combination by selecting from the below, available in both Chrome and Gold



Single outlet version, for showers with either a fixed overhead or a flexible hose and handspray

Two outlet version for two shower outlets or for one shower and bath filling. The two outlet valve can be installed with both a fixed and flexible shower, it has a built-in diverter to switch between the two

**Single Outlet**

Chrome: R1SV CHR  
 Gold: R1SV GOLD

**Dual Outlet**

Chrome: R2SV CHR  
 Gold: R2SV GOLD

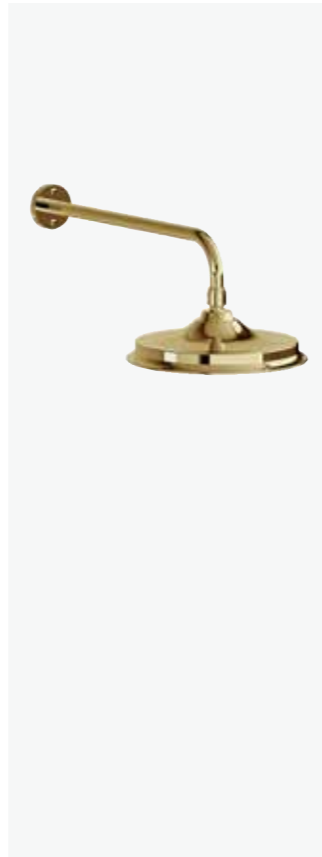

**Straight shower arm**

6", 9" or 12" AirBurst shower head  
 (9" only for Gold)

**Shower Arm**

Chrome: V11  
 Gold: V11 GOLD

**Shower Head**

6" Chrome: V16  
 9" Chrome: V17  
 12" Chrome: V60  
 9" Gold: V17 GOLD



100mm slidebar with adjustable bracket

**Slidebar**

Chrome: RIV37 CHR  
 Gold: RIV37 GOLD



The flexible hose and handspray is supplied with wall outlet and shower station as shown. It can also be used with optional slide bar.

**Fixed Hose and Handspray**

Chrome: RIV20 CHR  
 Gold: RIV20 GOLD

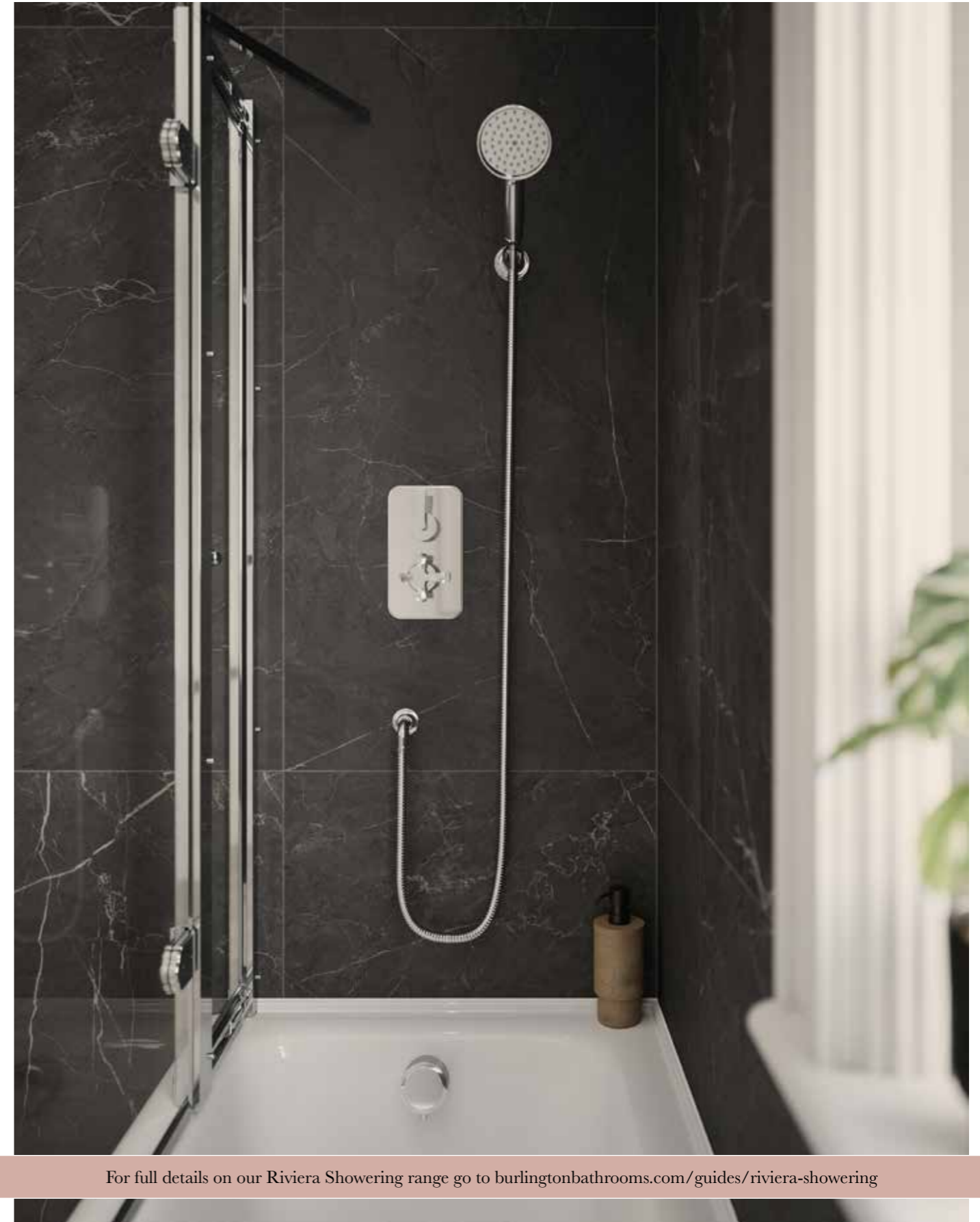

For full details on our Riviera Showering range go to [burlingtonbathrooms.com/guides/riviera-showering](http://burlingtonbathrooms.com/guides/riviera-showering)

## HINGED DOORS



900 x 900 Hinged Doors - Shown with Trent Shower

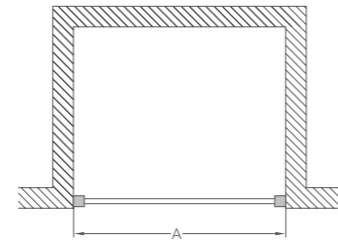

- 1950mm High
- Adjustable up to 20mm from each wall
- Constructed from aluminium
- Can be installed with or without chrome ball header
- Safety glass is 8mm thick
- 3M™ easy clean coating

High Flow Vortex Shower Waste

Chrome: Z1205

Size*	Adjustment min-max	Enclosure code	Tray code
760 x 760	720 - 760	BU1 (C19)	Z1159
800 x 800	760 - 800	BU2 (C20)	Z1160
900 x 760	860 - 900	BU3 (C21)	Z1163
900 x 800	860 - 900	BU3 (C21)	Z1164
900 x 900	860 - 900	BU3 (C21)	Z1161
900 x 1200	860 - 900	BU3 (C21)	Z1176

\*This indicates depth of matching tray size available for use in a recessed installation.

## HINGED DOORS & SIDE PANELS



900 x 900 Hinged Doors & Side Panel - Shown with Severn Shower

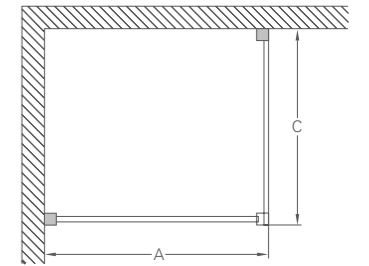

- 1950mm High
- Adjustable up to 20mm from each wall
- Constructed from aluminium
- Can be installed with or without chrome ball header
- Safety glass is 8mm thick
- 3M™ easy clean coating

High Flow Vortex Shower Waste

Chrome: Z1205

Size*	Adjustment min-max	Enclosure code	Tray code
760 x 900	730 - 750 / 870 - 890	BU12 (C19 + C14)	Z1163
800 x 800	770 - 790	BU13 (C20 + C13)	Z1160
800 x 800	770 - 790 / 870 - 890	BU14 (C20 + C14)	Z1164
900 x 800	770 - 790 / 870 - 890	BU16 (C21 + C13)	Z1164
900 x 900	870 - 900	BU17 (C21 + C14)	Z1161

\*This indicates depth of matching tray size available for use in a recessed installation.

## HINGED DOORS WITH INLINE PANELS

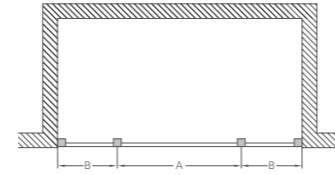

- 1950mm High
- Adjustable up to 20mm from each wall
- Constructed from aluminium
- Can be installed with or without chrome ball header
- Safety glass is 8mm thick
- 3M™ easy clean coating

High Flow Vortex Shower Waste  
**Chrome: Z1205**

900 x 1400 Hinged Doors with Inline Panels - Shown with Avon Shower

Size*	Adjustment min-max	Enclosure code	Tray code
1000 x 700	960 - 1000	BU4 (C20 + C15)	Z1165
1000 x 760	960 - 1000	BU4 (C20 + C15)	Z1166
1000 x 800	960 - 1000	BU4 (C20 + C15)	Z1167
1000 x 900	960 - 1000	BU4 (C20 + C15)	Z1168
1000 x 1000	960 - 1000	BU4 (C20 + C15)	Z1162
1100 x 700	1060 - 1100	BU5 (C20 + C16)	Z1169
1100 x 760	1060 - 1100	BU5 (C20 + C16)	Z1170
1100 x 800	1060 - 1100	BU5 (C20 + C16)	Z1171
1100 x 900	1060 - 1100	BU5 (C20 + C16)	Z1172
1200 x 700	1160 - 1200	BU6 (C20 + C17)	Z1173
1200 x 760	1160 - 1200	BU6 (C20 + C17)	Z1174
1200 x 800	1160 - 1200	BU6 (C20 + C17)	Z1175
1200 x 900	1160 - 1200	BU6 (C20 + C17)	Z1176
1400 x 800	1360 - 1400	BU7 (C20 + C16 + C17)	Z1177
1400 x 900	1360 - 1400	BU7 (C20 + C16 + C17)	Z1178
1500 x 700	1460 - 1500	BU8 (C21 + C16 + C16)	Z1179
1500 x 760	1460 - 1500	BU8 (C21 + C16 + C16)	Z1180
1500 x 800	1460 - 1500	BU8 (C21 + C16 + C16)	Z1181
1600 x 700	1560 - 1600	BU9 (C20 + C17 + C17)	Z1182
1700 x 700	1660 - 1700	BU10 (C21 + C17 + C17)	Z1183
1700 x 760	1660 - 1700	BU10 (C21 + C17 + C17)	Z1184
1700 x 800	1660 - 1700	BU10 (C21 + C17 + C17)	Z1185

\*This indicates depth of matching tray size available for use in a recessed installation.

## HINGED DOORS WITH INLINE & SIDE PANELS

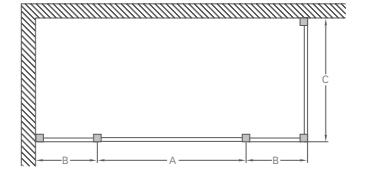

- 1950mm High
- Adjustable up to 20mm from each wall
- Constructed from aluminium
- Can be installed with or without chrome ball header
- Safety glass is 8mm thick
- 3M™ easy clean coating

High Flow Vortex Shower Waste  
**Chrome: Z1205**

900 x 1400 Hinged Doors with Inline & Side Panels - Shown with Eden Shower

Size*	Adjustment min-max	Enclosure code	Tray code
1000 x 800	770 - 790 / 970 - 990	BU20 (C20 + C15 + C13)	Z1167
1000 x 900	870 - 890 / 970 - 990	BU21 (C20 + C15 + C14)	Z1168
1100 x 800	770 - 790 / 1070 - 1090	BU24 (C20 + C16 + C13)	Z1171
1100 x 900	870 - 890 / 1070 - 1090	BU25 (C20 + C16 + C14)	Z1172
1200 x 800	770 - 790 / 1170 - 1190	BU28 (C20 + C17 + C13)	Z1175
1200 x 900	870 - 890 / 1170 - 1190	BU29 (C20 + C17 + C14)	Z1176
1400 x 800	770 - 790 / 1370 - 1390	BU30 (C20 + C16 + C16 + C13)	Z1177
1400 x 900	870 - 890 / 1370 - 1390	BU31 (C20 + C16 + C16 + C14)	Z1178
1500 x 800	770 - 790 / 1470 - 1490	BU34 (C21 + C16 + C16 + C13)	Z1181
1700 x 800	770 - 790 / 1670 - 1690	BU38 (C21 + C17 + C17 + C13)	Z1185

\*This indicates depth of matching tray size available for use in a recessed installation.

# QUADRANTS



900 x 900 Quadrant - Shown with Stour Shower

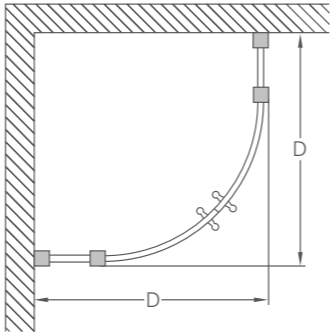

- 1950mm High
- Adjustable up to 20mm from each wall
- Constructed from aluminium
- Can be installed with or without chrome ball header
- Safety glass is 8mm thick
- 3M™ easy clean coating

High Flow Vortex Shower Waste

Chrome: Z1205

Size*	Adjustment min-max	Enclosure code	Tray code
800 x 800	770 - 790	BU39 (C22)	Z1192
900 x 900	870 - 890	BU40 (C23)	Z1193

\*This indicates depth of matching tray size available for use in a recessed installation.

# OFFSET QUADRANTS



900 x 1200 Offset Quadrant (Right Handed) - Shown with Stour Shower

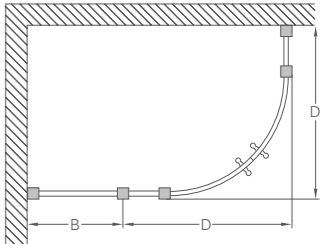

Right Handed

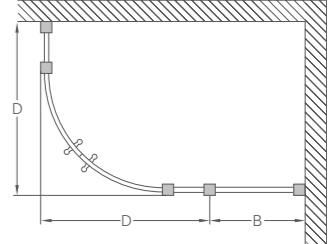

Left Handed

- 1950mm High
- Adjustable up to 20mm from each wall
- Constructed from aluminium
- Can be installed with or without chrome ball header
- Safety glass is 8mm thick
- 3M™ easy clean coating

High Flow Vortex Shower Waste

Chrome: Z1205

Size*	Adjustment min-max	Enclosure code	Tray code
800 x 1000 Left Handed	770 - 790 / 970 - 990	BU41 (C22 + C15)	Z1199
800 x 1000 Right Handed	770 - 790 / 970 - 990	BU41 (C22 + C15)	Z1200
800 x 1200 Left Handed	770 - 790 / 1170 - 1190	BU91 (C22 + C17)	Z1201
800 x 1200 Right Handed	770 - 790 / 1170 - 1190	BU91 (C22 + C17)	Z1202
900 x 1200 Left Handed	870 - 890 / 1170 - 1190	BU42 (C23 + C16)	Z1203
900 x 1200 Right Handed	870 - 890 / 1170 - 1190	BU42 (C23 + C16)	Z1204

\*This indicates depth of matching tray size available for use in a recessed installation.

## SLIDING DOORS



1200 x 900 Sliding Doors with Inline Panels - Shown with Trent Shower

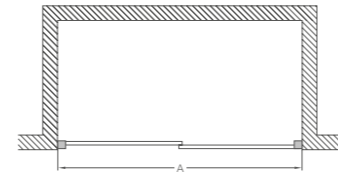

Sliding door

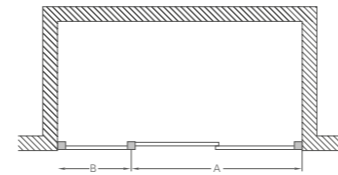

Sliding door with in line panel

- 1950mm High
- Adjustable up to 20mm from each wall
- Constructed from aluminium
- Can be installed with or without chrome ball header
- Safety glass is 8mm thick
- 3M™ easy clean coating

High Flow Vortex Shower Waste

Chrome: Z1205

## SLIDING DOORS WITH SIDE PANELS



1200 x 900 Sliding Doors with Inline & Side Panels - Shown with Avon Shower

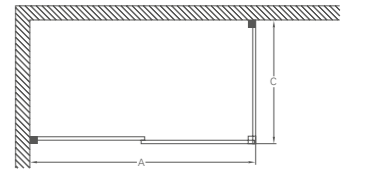

Sliding door with side panel

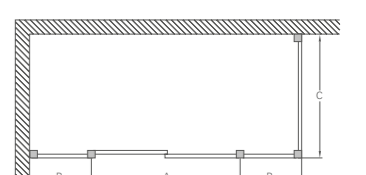

Sliding door with in line and side panel

- 1950mm High
- Adjustable up to 20mm from each wall
- Constructed from aluminium
- Can be installed with or without chrome ball header
- Safety glass is 8mm thick
- 3M™ easy clean coating

High Flow Vortex Shower Waste

Chrome: Z1205

### Soft-Close Sliding Door with Side Panel

Size*	Adjustment min-max	Enclosure code	Tray code
1100 x 700	1060 - 1100	C6S	Z1169
1100 x 760	1060 - 1100	C6S	Z1170
1100 x 800	1060 - 1100	C6S	Z1171
1100 x 900	1060 - 1100	C6S	Z1172
1200 x 700	1160 - 1200	C7S	Z1173
1200 x 760	1160 - 1200	C7S	Z1174
1200 x 800	1160 - 1200	C7S	Z1175
1200 x 900	1160 - 1200	C7S	Z1176

### Soft-Close Sliding Door with In Line & Side Panel

Size*	Adjustment min-max	Enclosure code	Tray code
1500 x 700	1460 - 1500	BU71 (C7S + C16)	Z1179
1500 x 760	1460 - 1500	BU71 (C7S + C16)	Z1180
1500 x 800	1460 - 1500	BU71 (C7S + C16)	Z1181

\*This indicates depth of matching tray size available for use in a recessed installation.

### Soft-Close Sliding Door with Side Panel

Size*	Adjustment min-max	Enclosure code	Tray code
1100 x 800	770 - 790 / 1070 - 1090	BU76 (C6S + C13)	Z1171
1100 x 900	870 - 890 / 1070 - 1090	BU77 (C6S + C14)	Z1172
1200 x 800	770 - 790 / 1070 - 1090	BU80 (C7S + C13)	Z1175
1200 x 900	870 - 890 / 1070 - 1090	BU81 (C7S + C14)	Z1176

### Soft-Close Sliding Door with In Line & Side Panel

Size*	Adjustment min-max	Enclosure code	Tray code
1500 x 800	770 - 790 / 1470 - 1490	BU86 (C7S + C16 + C13)	Z1181

\*This indicates depth of matching tray size available for use in a recessed installation.

# ACCESSORIES

Burlington bathrooms offer a range of accessories, radiators, mirrors and lights for the perfect finishing touch to your traditionally styled bathroom.

## COLOUR OPTIONS

Continue luxury styling throughout your classic themed bathroom with a range of accessories combining Chrome, Nickel or Gold plated solid brass with White ceramic so your bathroom not only looks beautifully traditional but is effortlessly functional too.



### Accessories

Continue luxury styling throughout your classic themed bathroom with a range of accessories in a selection of finishes. Choose from White, Chrome, Nickel or Gold finish.



### Radiators

Complete your traditional bathroom with a choice of radiators in either White and Chrome, Black and Chrome or Chrome.



### Mirrors

Add a finishing touch to your bathroom with a Burlington mirror. Opt for curved, rectangular or arched mirrors or select from a choice of three ornate aluminium finishes.



### Lights

Choose from a selection of Burlington and Arcade lights with Chrome or Nickel bases and a choice of either glass or chiffon shades.

## GUARANTEES

\*For full details on guarantees please visit [burlingtonbathrooms.com/guarantee](http://burlingtonbathrooms.com/guarantee).

Accessories

15  
YEAR

Guarantee\*

Mirrors

5  
YEAR

Guarantee\*

Radiators

5  
YEAR

Guarantee\*

Lights

5  
YEAR

Guarantee\*

# ACCESSORIES

156  
ACCESSORIES

158  
RADIATORS

159  
MIRRORS

160  
LIGHTS

# ACCESSORIES



Soap Dish  
**W:** 160 **L:** 150 **H:** 60  
**Chrome:** A1 CHR  
**Nickel:** A1 NKL  
**Gold:** A1 GOLD



Tumbler Holder  
**W:** 80 **L:** 120 **H:** 110  
**Chrome:** A2 CHR  
**Nickel:** A2 NKL  
**Gold:** A2 GOLD



WC Brush Holder  
**W:** 100 **L:** 150 **H:** 430  
**Chrome:** A8 CHR  
**Nickel:** A8 NKL  
**Gold:** A8 GOLD



Towel Ring  
**W:** 170 **L:** 60 **H:** 200  
**Chrome:** A3 CHR  
**Nickel:** A3 NKL  
**Gold:** A3 GOLD



Medium Ornate Bracket  
**W:** 230 **L:** 20 **H:** 160  
**Code:** T32 CHR



Glass Shelf with Railing  
**W:** 530 **L:** 160 **H:** 60  
**Chrome:** A18 CHR  
**Gold:** A18 GOLD



Brass Extendible Bath Rack  
**W:** 590-900 **L:** 210 **H:** 90  
**Code:** A27 CHR



Soap Basket  
**W:** 140 **L:** 120 **H:** 60  
**Code:** A13 CHR



Accessory Back Plate  
**W:** 30 **L:** 60 **H:** 60  
**Chrome:** G13



Single Soap Dispenser  
**W:** 80 **L:** 140 **H:** 210  
**Chrome:** A19 CHR  
**Nickel:** A19 NKL  
**Gold:** A19 GOLD



Double Soap Dispenser  
**W:** 190 **L:** 130 **H:** 210  
**Code:** A20 CHR



Surface Mounted Soap Dispenser  
**W:** 70 **L:** 70 **H:** 110  
**Code:** A48 CHR

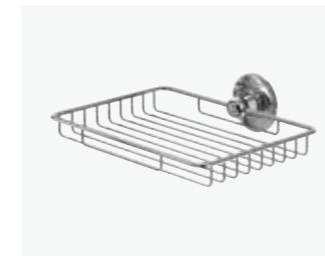

Sponge Basket  
**W:** 220 **L:** 180 **H:** 60  
**Code:** A15 CHR



Wire Basket  
**W:** 330 **L:** 160 **H:** 90  
**Code:** A23 CHR



Corner Basket  
**W:** 220 **L:** 220 **H:** 60  
**Code:** A21 CHR



Deep Corner Basket  
**W:** 280 **L:** 280 **H:** 90  
**Code:** A22 CHR



WC Roll Holder  
**W:** 80 **L:** 180 **H:** 120  
**Chrome:** A5 CHR  
**Nickel:** A5 NKL  
**Gold:** A5 GOLD



WC Roll Holder  
**W:** 100 **L:** 180 **H:** 100  
**Code:** A16 CHR



Spire WC Roll Holder  
**W:** 170 **L:** 60 **H:** 250  
**Code:** A45 CHR



Spare WC Roll Holder  
**W:** 120 **L:** 60 **H:** 80  
**Code:** A6 CHR



Towel Rack  
**W:** 660 **L:** 320 **H:** 140  
**Chrome:** A46 CHR  
**Gold:** A46 GOLD



Single Towel Rail  
**W:** 550 **L:** 60 **H:** 60  
**Code:** A7 CHR



Double Towel Rail  
**W:** 660 **L:** 150 **H:** 170  
**Code:** A17 CHR



Robe Hook  
**W:** 60 **L:** 60 **H:** 60  
**Chrome:** A14 CHR  
**Nickel:** A14 NKL  
**Gold:** A14 GOLD

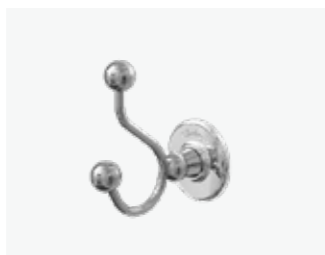

Double Robe Hook  
**W:** 60 **L:** 110 **H:** 120  
**Chrome:** A4 CHR  
**Nickel:** A4 NKL  
**Gold:** A4 GOLD

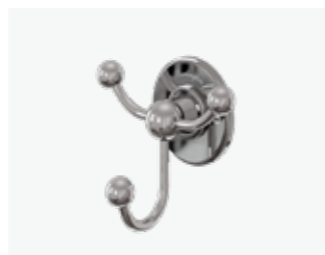

Triple Robe Hook  
**W:** 100 **L:** 70 **H:** 90  
**Code:** A47 CHR

## COLOUR CHOICES

A selection of our accessories are available in a range of finishes and accents. See below for a few examples. For details on exact finishes visit our website.





# RADIATORS



Trafalgar  
W: 642 L: 235 H: 950  
Code: R1 CHR



Trafalgar Black  
W: 642 L: 235 H: 950  
Code: R1 CHR BLA



Bloomsbury  
W: 497 L: 235 H: 950  
Code: R2 CHR



Bloomsbury Black  
W: 497 L: 235 H: 950  
Code: R2 CHR BLA



Chaplin  
W: 542 L: 126 H: 1142  
Code: R12 CHR



Vincent  
W: 642 L: 235 H: 950  
Code: R5 CHR



Berkeley  
W: 642 L: 235 H: 950  
Code: R4 CHR



Cleaver  
W: 642 L: 235 H: 950  
Code: R3 CHR



Strand  
W: 642 L: 390 H: 404  
Code: R11 CHR



Straight Radiator Valves  
Code: R7 CHR



Angled Radiator Valves  
Chrome: R6 CHR  
Black: R6 CHR BLA

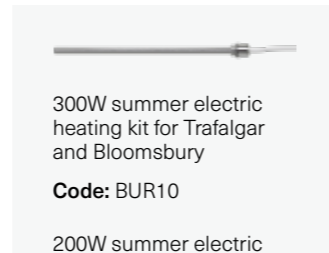

300W summer electric heating kit for Trafalgar and Bloomsbury  
Code: BUR10

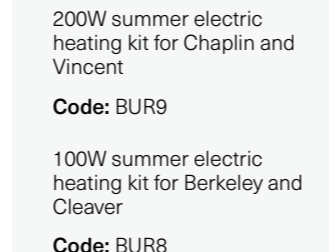

200W summer electric heating kit for Chaplin and Vincent  
Code: BUR9

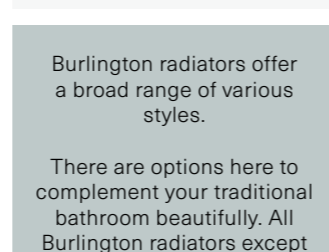

100W summer electric heating kit for Berkeley and Cleaver  
Code: BUR8

Type	ΔT=50°c Watts	ΔT=55°c Watts	ΔT=60°c Watts	BTU's	DM3
Trafalgar	475	540	600	2047	7.2
Bloomsbury	356	400	445	1518	5.0
Vincent	219	250	280	955	2.9
Berkeley	180	210	240	819	2.4
Cleaver	164	190	210	717	2.2
Strand	218	250	280	955	2.4
Chaplin	235	268	300	1024	3.4

Maximum capacity when using a heating element is 90% of full capacity. Please consult the installation guide for each model.

Burlington radiators offer a broad range of various styles.

There are options here to complement your traditional bathroom beautifully. All Burlington radiators except the Strand (R11 CHR) are designed to work with the extra fitting of an electric summer heating kit, allowing warm towels all year round.

# MIRRORS



Distressed Aluminium Frame  
W: 550 D: 40 H: 750  
Code: T37 ALU



Black Aluminium Frame  
W: 550 D: 40 H: 750  
Code: T47 BLA



White Aluminium Frame  
W: 550 D: 40 H: 750  
Code: T42 WHI



Cosmetic Wall Mirror  
W: 180 D: 285 H: 340-440  
Code: A57 CHR



Arched  
W: 500 D: 30 H: 700  
Code: A9



Rectangular  
W: 500 D: 30 H: 700  
Code: A11



Curved  
W: 700 D: 30 H: 700  
Code: A38



Rectangular Swivel Mirror with Curved Corners  
W: 590 D: 66 H: 620  
Chrome: A40 CHR  
Nickel: A40 NKL



# LIGHTS



Round Light with Chrome Base and Cup Frosted Glass Shade  
**Code:** EL/BL11



Round Light with Chrome Base and Vase Clear Glass Shade  
**Code:** EL/BL14



Round Light with Chrome Base and Tube Frosted Glass Shade  
**Code:** EL/BL13



Round Light with Chrome Base and White Fine Pleated Shade  
**Code:** EL/BL12



Round Light with Chrome Base and Silver Chiffon Shade  
**Code:** EL/BL15

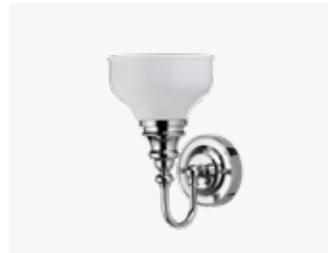

Ornate Light with Chrome Base and Cup Frosted Glass Shade  
**Code:** EL/BL21



Ornate Light with Chrome Base and Vase Clear Glass Shade  
**Code:** EL/BL24



Ornate Light with Chrome Base and Tube Frosted Glass Shade  
**Code:** EL/BL23



Ornate Light with Chrome Base and White Fine Pleated Shade  
**Code:** EL/BL22



Ornate Light with Chrome Base and Silver Chiffon Shade  
**Code:** EL/BL25

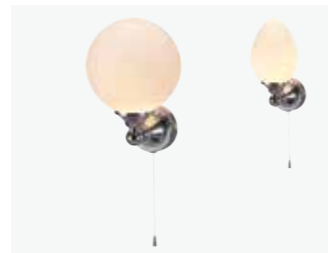

Edwardian Chrome Single Round LED Light  
**Round:** T50  
**Elliptical:** T52

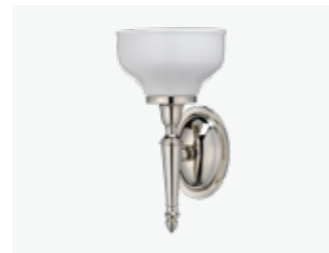

Arcade Oval Light with Nickel Base and Cup Frosted Glass Shade  
**Code:** EL/AL11



Arcade Oval Light with Nickel Base and Vase Clear Glass Shade  
**Code:** EL/AL14



Arcade Oval Light with Nickel Base and Tube Frosted Glass Shade  
**Code:** EL/AL13



Arcade Oval Light with Nickel Base and White Fine Pleated Shade  
**Code:** EL/AL12



Arcade Oval Light with Nickel Base and Silver Chiffon Shade  
**Code:** EL/AL15

## ONLINE

You can view all of the Burlington collections on our website alongside exclusive videos, styling tips for your bathroom and technical details about the product. If you would prefer to view in person, you can use the website's showroom locator to find your nearest Burlington display.

## IN STORE

There is a local Burlington specialist near you. To find your nearest retailer, search our website under [burlingtonbathrooms.com/find-a-retailer](http://burlingtonbathrooms.com/find-a-retailer)

## GUARANTEES

All Burlington products are made using the highest quality materials and are produced to meet or exceed European and U.K. Standards. With correct installation and use the products will give many years of trouble-free service.

All products within the brand are covered by Burlington's guarantees. Burlington guarantees are subject to online registration. Lifetime guarantees represent the perceived lifetime of the product which is 25 years.

For more information on guarantees visit [burlingtonbathrooms.com/guarantee](http://burlingtonbathrooms.com/guarantee)

## INSPIRATION

Follow us on



[burlingtonbathrooms.com](http://burlingtonbathrooms.com)

Due to continuous product improvements we reserve the right to change the product specification without prior notice. The text, images and layout of this catalogue are protected by copyright and other intellectual property rights. All images within this brochure are, where possible, a true representation of our products. Some colours may vary. Please visit the websites for more information.

Our websites should be used as reference for the most up to date product specification.