



M O D U M

**ITALIER**

---

NEW YORK



*Dal Latino, la parola Modus/Modum indica equilibrio,  
classe ed eleganza nei modi.*

*The original Latin word Modus/Modum was used to describe equilibrium,  
class and elegance in being.*

*С латинского языка Модус/Модум можно отнести к сбалансированности,  
классу и элегантности.*

## NEW YORK

*Fifth Avenue*

---

— Spazi ampi e vetrate cariche di luce si affacciano sullo skyline della metropoli: interni di lussuosa modernità dove la collezione di sedute NEW YORK dispiega la sua eleganza e il suo fascino.

— Wide spaces and luminous glass windows overlooking the city skyline: luxurious and modern interiors where NEW YORK can display its charm and elegance.



— *Composizione NY 15 in Eco-Nabuck col. 12.*  
— *Composition NY 15 in Eco Nubuck col. 12.*

— *Composizione in tessuto Eco Nabuck col. 59 muschio.*  
— *Composition in Eco Nubuck col. 59 muschio.*





— *Composizione in tessuto Eco Nabuck col. 48 carta da zucchero.*

— *Composition in Eco Nabuck col. 48 carta da zucchero.*

---

— *New York non è un semplice salotto, è molto di più: una combinazione creativa di sedute come in un giuoco di 'lego' per adulti raffinati ed esigenti.  
Disponibile con o senza cilindro sullo schienale (vedi pag. 16-17)*

— *New York is not a mere sofa but much more: a creative combination of seats as in a 'Lego' for refined and exacting adults.  
Available with or without cylinder along the back. ( see. Page 16-17)*



— Qui e nelle pagine successive: Composizione in tessuto Zeph 01.

— Here and in the next pages: Composition in Zeph 01.









---

— *Versatile a polivalente: il divano New York si adatta a qualsiasi ambiente e arredamento.  
Ecopelle Nabuck disponibile in vari colori sia liscia che trapuntata.*

— *Versatile and multi-fuctional, NEW YORK sofa adapts itself to any interior setting.  
Ecoleather Nabuck available in different colours in both plain and quilted version.*





— Qui e nella pagina successiva:  
Composizione NY 19 con pouf. Tessuto Zeph col. 16.

— Here and in the following pages:  
Composition NY 19 with pouf. Fabric Zeph col. 16.





— *Composizione in tessuto Eco Nabuck col. 59 muschio.*  
— *Composition in Eco Nubuck col. 59 muschio.*





ART. NABUCK – COLOR: 11

SCALE 35:100



ART. NABUCK – COLOR: 12

SCALE 35:100



ART. NABUCK – COLOR: 44

SCALE 35:100



ART. NABUCK – COLOR: 48

SCALE 35:100



ART. NABUCK – COLOR: 28

SCALE 35:100



ART. NABUCK – COLOR: 35

SCALE 35:100



ART. NABUCK – COLOR: 59

SCALE 35:100

## CUSHIONS "PREMIUM"

---



ART. RELAX – COLOR: 48



ART. TRACOLLA – COLOR: 48



ART. PON PON – COLOR: 59



ART. 24 HOURS – COLOR: 59



ART. ROUND CLIP – COLOR: 11



ART. FIOCCO – COLOR: 11



ART. 24 HOURS – COLOR: 28



ART. CLIP – COLOR: 28

# NEW-YORK

## ELEMENTS

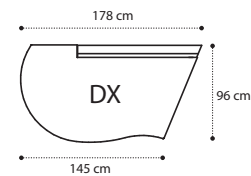

**ELEMENTO A (DX)**  
ELEMENT A (DX)  
ЭЛЕМЕНТ А (DX)

€ 1134 (A)  
€ 1198 (B)  
€ 1262 (C)  
€ 1334 (D)  
€ 1365 (E)  
€ 1417 (F)  
€ 1494 (G)  
€ 1597 (H)  
€ 1751 (I)

1,7 m<sup>3</sup> - 45,7 kg.

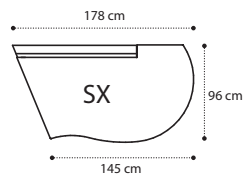

**ELEMENTO A (SX)**  
ELEMENT A (SX)  
ЭЛЕМЕНТ А (SX)

€ 1134 (A)  
€ 1198 (B)  
€ 1262 (C)  
€ 1334 (D)  
€ 1365 (E)  
€ 1417 (F)  
€ 1494 (G)  
€ 1597 (H)  
€ 1751 (I)

1,7 m<sup>3</sup> - 45,7 kg.

## C = VIP E = LUX

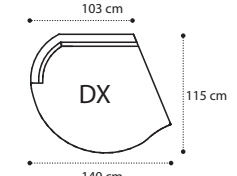

**ELEMENTO B (DX)**  
ELEMENT B (DX)  
ЭЛЕМЕНТ В (DX)

€ 1043 (A)  
€ 1098 (B)  
€ 1153 (C)  
€ 1215 (D)  
€ 1242 (E)  
€ 1286 (F)  
€ 1352 (G)  
€ 1441 (H)  
€ 1573 (I)

0,92 m<sup>3</sup> - 42,8 kg.

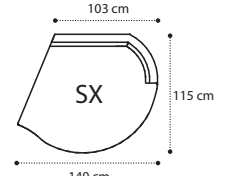

**ELEMENTO B (SX)**  
ELEMENT B (SX)  
ЭЛЕМЕНТ В (SX)

€ 1043 (A)  
€ 1098 (B)  
€ 1153 (C)  
€ 1215 (D)  
€ 1242 (E)  
€ 1286 (F)  
€ 1352 (G)  
€ 1441 (H)  
€ 1573 (I)

0,92 m<sup>3</sup> - 42,8 kg.

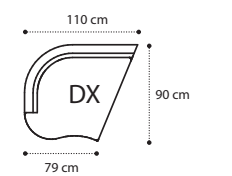

**ELEMENTO C (DX)**  
ELEMENT C (DX)  
ЭЛЕМЕНТ С (DX)

€ 905 (A)  
€ 950 (B)  
€ 995 (C)  
€ 1046 (D)  
€ 1068 (E)  
€ 1104 (F)  
€ 1159 (G)  
€ 1231 (H)  
€ 1340 (I)

1,02 m<sup>3</sup> - 33,6 kg.

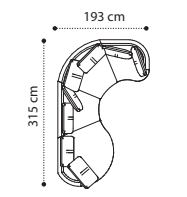

**NY/02A**  
Bdx + F + E + Csx + 7xM

€ 4220 (A)  
€ 4459 (B)  
€ 4691 (C)  
€ 4960 (D)  
€ 5074 (E)  
€ 5260 (F)  
€ 5546 (G)  
€ 5927 (H)  
€ 6496 (I)

4,7 m<sup>3</sup> - 156 kg.

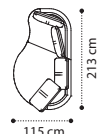

**NY/02B**  
Cdx + Bsx + 4xM

€ 2280 (A)  
€ 2408 (B)  
€ 2532 (C)  
€ 2677 (D)  
€ 2738 (E)  
€ 2838 (F)  
€ 2991 (G)  
€ 3196 (H)  
€ 3501 (I)

2,14 m<sup>3</sup> - 82 kg.

## C = VIP E = LUX

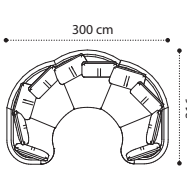

**NY/03**  
Cdx + 3xE + Csx + 11xM

€ 5279 (A)  
€ 5575 (B)  
€ 5860 (C)  
€ 6194 (D)  
€ 6334 (E)  
€ 6563 (F)  
€ 6917 (G)  
€ 7386 (H)  
€ 8089 (I)

6,61 m<sup>3</sup> - 198,1 kg.

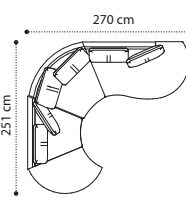

**NY/04**  
Idx + F + E + Asx + 6xM

€ 3906 (A)  
€ 4128 (B)  
€ 4343 (C)  
€ 4592 (D)  
€ 4697 (E)  
€ 4871 (F)  
€ 5135 (G)  
€ 5788 (H)  
€ 6016 (I)

4,8 m<sup>3</sup> - 143,4 kg.

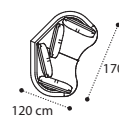

**NY/05A**  
Cdx + Csx + 3xM

€ 2059 (A)  
€ 2170 (B)  
€ 2278 (C)  
€ 2404 (D)  
€ 2457 (E)  
€ 2544 (F)  
€ 2678 (G)  
€ 2855 (H)  
€ 3121 (I)

2,19 m<sup>3</sup> - 71,4 kg.

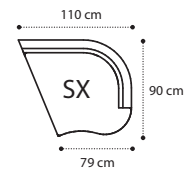

**ELEMENTO C (SX)**  
ELEMENT C (SX)  
ЭЛЕМЕНТ С (SX)

€ 905 (A)  
€ 950 (B)  
€ 995 (C)  
€ 1046 (D)  
€ 1068 (E)  
€ 1104 (F)  
€ 1159 (G)  
€ 1231 (H)  
€ 1340 (I)

1,02 m<sup>3</sup> - 33,6 kg.

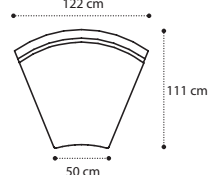

**ELEMENTO E**  
ELEMENT E  
ЭЛЕМЕНТ Е

€ 852 (A)  
€ 895 (B)  
€ 938 (C)  
€ 986 (D)  
€ 1007 (E)  
€ 1041 (F)  
€ 1093 (G)  
€ 1161 (H)  
€ 1264 (I)

1,34 m<sup>3</sup> - 38,5 kg.

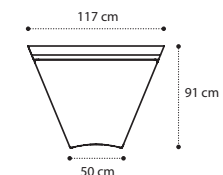

**ELEMENTO F**  
ELEMENT F  
ЭЛЕМЕНТ F

€ 839 (A)  
€ 886 (B)  
€ 933 (C)  
€ 985 (D)  
€ 1008 (E)  
€ 1045 (F)  
€ 1102 (G)  
€ 1177 (H)  
€ 1290 (I)

1,07 m<sup>3</sup> - 31,3 kg.

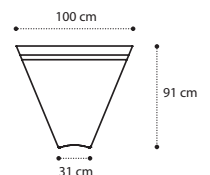

**ELEMENTO G**  
ELEMENT G  
ЭЛЕМЕНТ G

€ 740 (A)  
€ 764 (B)  
€ 788 (C)  
€ 815 (D)  
€ 827 (E)  
€ 846 (F)  
€ 874 (G)  
€ 913 (H)  
€ 970 (I)

0,98 m<sup>3</sup> - 28,8 kg.

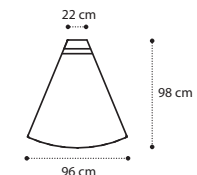

**ELEMENTO H**  
ELEMENT H  
ЭЛЕМЕНТ H

€ 679 (A)  
€ 703 (B)  
€ 727 (C)  
€ 754 (D)  
€ 765 (E)  
€ 784 (F)  
€ 813 (G)  
€ 851 (H)  
€ 909 (I)

1,00 m<sup>3</sup> - 26,6 kg.

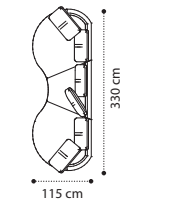

**NY/05B**  
Bdx + Bsx + F + 5xM

€ 3064 (A)  
€ 3236 (B)  
€ 3403 (C)  
€ 3597 (D)  
€ 3679 (E)  
€ 3813 (F)  
€ 4020 (G)  
€ 4294 (H)  
€ 4705 (I)

3,36 m<sup>3</sup> - 105,5 kg.

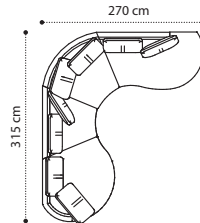

**NY/06**  
Bdx + F + E + Asx + 9xM

€ 4615 (A)  
€ 4887 (B)  
€ 5150 (C)  
€ 5456 (D)  
€ 5585 (E)  
€ 5797 (F)  
€ 6121 (G)  
€ 6555 (H)  
€ 7201 (I)

5,48 m<sup>3</sup> - 170,9 kg.

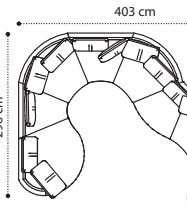

**NY/07**  
Bdx + G + E + F + E + H + E + Asx + 11xM

€ 7904 (A)  
€ 8324 (B)  
€ 8733 (C)  
€ 9205 (D)  
€ 9405 (E)  
€ 9733 (F)  
€ 10234 (G)  
€ 10903 (H)  
€ 11902 (I)

10,24 m<sup>3</sup> - 306,1 kg.

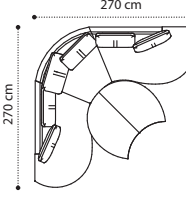

**NY/08**  
Adx + Asx + E + Idx + Isx + 6xM

€ 4784 (A)  
€ 5049 (B)  
€ 5306 (C)  
€ 5604 (D)  
€ 5729 (E)  
€ 5939 (F)  
€ 6253 (G)  
€ 6675 (H)  
€ 7306 (I)

5,82 m<sup>3</sup> - 177,3 kg.

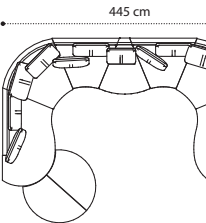

**NY/09**  
Adx + E + F + H + F + E + Asx + Idx + Isx + 11xM

€ 8408 (A)  
€ 8869 (B)  
€ 9317 (C)  
€ 9834 (D)  
€ 10052 (E)  
€ 10414 (F)  
€ 10963 (G)  
€ 11696 (H)  
€ 12794 (I)

10,55 m<sup>3</sup> - 312 kg.

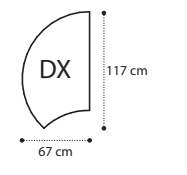

**ELEMENTO I (DX)**  
ELEMENT I (DX)  
ЭЛЕМЕНТ I (DX)

€ 583 (A)  
€ 609 (B)  
€ 634 (C)  
€ 663 (D)  
€ 675 (E)  
€ 696 (F)  
€ 726 (G)  
€ 767 (H)  
€ 829 (I)

0,39 m<sup>3</sup> - 19,5 kg.

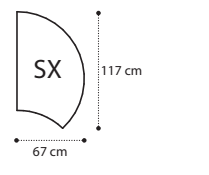

**ELEMENTO I (SX)**  
ELEMENT I (SX)  
ЭЛЕМЕНТ I (SX)

€ 583 (A)  
€ 609 (B)  
€ 634 (C)  
€ 663 (D)  
€ 675 (E)  
€ 696 (F)  
€ 726 (G)  
€ 767 (H)  
€ 829 (I)

0,39 m<sup>3</sup> - 19,5 kg.

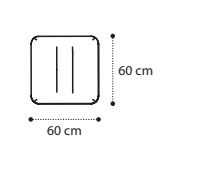

**ELEMENTO M**  
ELEMENT M  
ЭЛЕМЕНТ М

€ 83 (A)  
€ 90 (B)  
€ 96 (C)  
€ 104 (D)  
€ 107 (E)  
€ 112 (F)  
€ 120 (G)  
€ 131 (H)  
€ 147 (I)

0,05 m<sup>3</sup> - 1,4 kg.

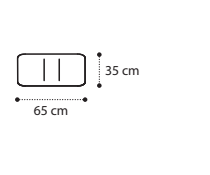

**ELEMENTO P**  
ELEMENT P  
ЭЛЕМЕНТ P

€ 52 (A)  
€ 55 (B)  
€ 59 (C)  
€ 63 (D)  
€ 65 (E)  
€ 68 (F)  
€ 73 (G)  
€ 79 (H)  
€ 87 (I)

0,03 m<sup>3</sup> - 0,7 kg.

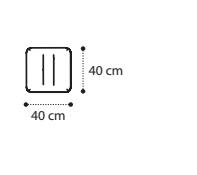

**ELEMENTO Q**  
ELEMENT Q  
ЭЛЕМЕНТ Q

€ 46 (A)  
€ 50 (B)  
€ 54 (C)  
€ 59 (D)  
€ 61 (E)  
€ 64 (F)  
€ 69 (G)  
€ 76 (H)  
€ 85 (I)

0,02 m<sup>3</sup> - 0,8 kg.

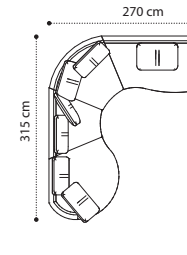

**NY/10**  
Asx + E + F + Bdx + 7xM

€ 4449 (A)  
€ 4707 (B)  
€ 4958 (C)  
€ 5248 (D)  
€ 5371 (E)  
€ 5573 (F)  
€ 5881 (G)  
€ 6293 (H)  
€ 6907 (I)

5,38 m<sup>3</sup> - 168,1 kg.

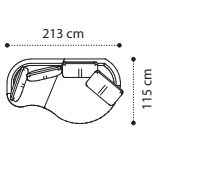

**NY/11**  
Bsx + Cdx + 4xM

€ 2280 (A)  
€ 2408 (B)  
€ 2532 (C)  
€ 2677 (D)  
€ 2738 (E)  
€ 2838 (F)  
€ 2991 (G)  
€ 3196 (H)  
€ 3501 (I)

2,14 m<sup>3</sup> - 82 kg.

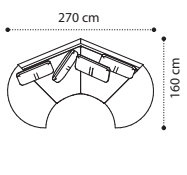

**NY/12**  
Idx + F + F + Isx + 4xM

€ 3176 (A)  
€ 3350 (B)  
€ 3518 (C)  
€ 3712 (D)  
€ 3794 (E)  
€ 3930 (F)  
€ 4136 (G)  
€ 4412 (H)  
€ 4826 (I)

3,12 m<sup>3</sup> - 107,2 kg.

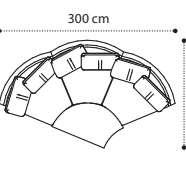

**NY/13**  
Isx + 3xE + 6xM

€ 3637 (A)  
€ 3834 (B)  
€ 4024 (C)  
€ 4245 (D)  
€ 4338 (E)  
€ 4491 (F)  
€ 4725 (G)  
€ 5036 (H)  
€ 5503 (I)

4,71 m<sup>3</sup> - 143,4 kg.

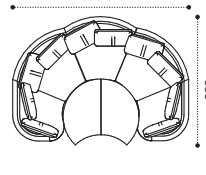

**NY/14**  
Idx + Isx + Cdx + 3xE + Csx + 10xM

€ 6362 (A)  
€ 6703 (B)  
€ 7032 (C)  
€ 7416 (D)  
€ 7577 (E)  
€ 7843 (F)  
€ 8249 (G)  
€ 8789 (H)  
€ 9600 (I)

7,34 m<sup>3</sup> - 235,7 kg.

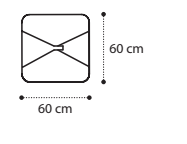

**ELEMENTO M PREMIUM**  
ELEMENT M PREMIUM  
ЭЛЕМЕНТ М ПРЕМИУМ

€ 120 (A)  
€ 126 (B)  
€ 133 (C)  
€ 140 (D)  
€ 143 (E)  
€ 149 (F)  
€ 156 (G)  
€ 167 (H)  
€ 183 (I)

0,05 m<sup>3</sup> - 1,4 kg.

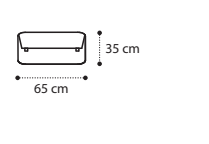

**ELEMENTO P PREMIUM**  
ELEMENT P PREMIUM  
ЭЛЕМЕНТ P ПРЕМИУМ

€ 101 (A)  
€ 105 (B)  
€ 109 (C)  
€ 113 (D)  
€ 115 (E)  
€ 118 (F)  
€ 122 (G)  
€ 128 (H)  
€ 137 (I)

0,03 m<sup>3</sup> - 0,7 kg.

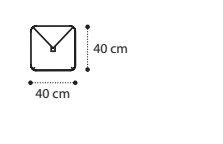

**ELEMENTO Q PREMIUM**  
ELEMENT Q PREMIUM  
ЭЛЕМЕНТ Q ПРЕМИУМ

€ 62 (A)  
€ 66 (B)  
€ 71 (C)  
€ 75 (D)  
€ 77 (E)  
€ 80 (F)  
€ 85 (G)  
€ 92 (H)  
€ 102 (I)

0,02 m<sup>3</sup> - 0,8 kg.

### OPTIONAL (4 FEET FOR ELEMENT)

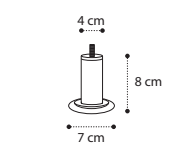

**PIEDINO CROMATO**  
CHROMED FOOT  
ХРОМИРОВАННАЯ НОЖКА

€ 12

0,3 kg.

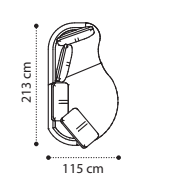
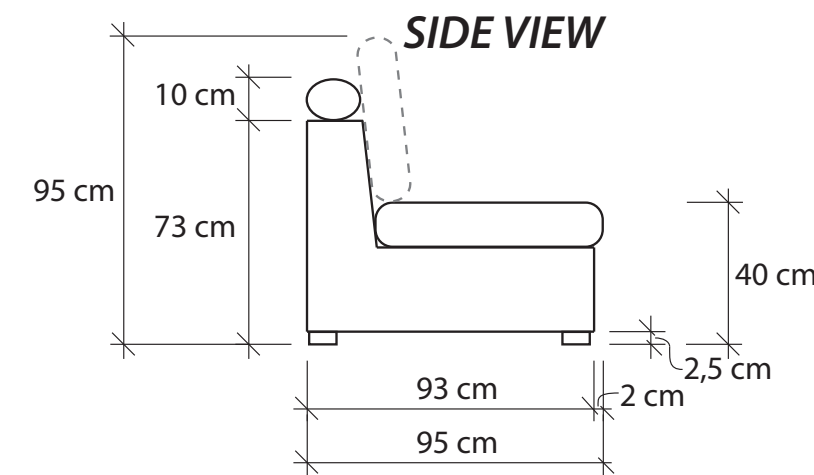

**NY/20A**  
Bdx + Csx + 4xM

€ 2280 (A)  
€ 2408 (B)  
€ 2532 (C)  
€ 2677 (D)  
€ 2738 (E)  
€ 2838 (F)  
€ 2991 (G)  
€ 3196 (H)  
€ 3501 (I)

2,14 m<sup>3</sup> - 82 kg.

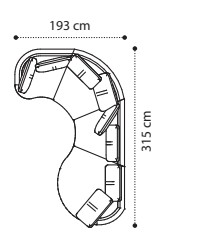

**NY/20B**  
Cdx + E + F + Bsx + 7xM

€ 4220 (A)  
€ 4459 (B)  
€ 4691 (C)  
€ 4960 (D)  
€ 5074 (E)  
€ 5260 (F)  
€ 5546 (G)  
€ 5927 (H)  
€ 6496 (I)

4,7 m<sup>3</sup> - 156 kg.

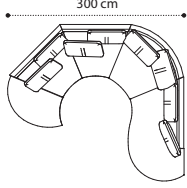

**NY/22**  
Idx + 2xF + E + Asx + 8xM

€ 4911 (A)  
€ 5194 (B)  
€ 5468 (C)  
€ 5785 (D)  
€ 5919 (E)  
€ 6140 (F)  
€ 6477 (G)  
€ 6927 (H)  
€ 7600 (I)

5,97 m<sup>3</sup> - 177,5 kg.

# NEW-YORK

## COMPOSITIONS

NOTA: La combinazione ecopelle Nabuck liscio e rombi, visibile in alcune composizioni fotografate, appartiene alla categoria C= VIP  
NOTE: The combination of ecoleather Nabuck plain and rhombs as per catalogue is category C= VIP  
ПРИМЕЧАНИЕ: Сочетание экокожи из нубука, гладкой и в ромбик, показанное на некоторых сфотографированных композициях, относится к категории C= VIP





M O D U M

**ITALIER**

[www.italier.cz](http://www.italier.cz) | [info@italier.cz](mailto:info@italier.cz) | +420 774 431 196