

# AIDA

## 6 DOORS WARDROBE

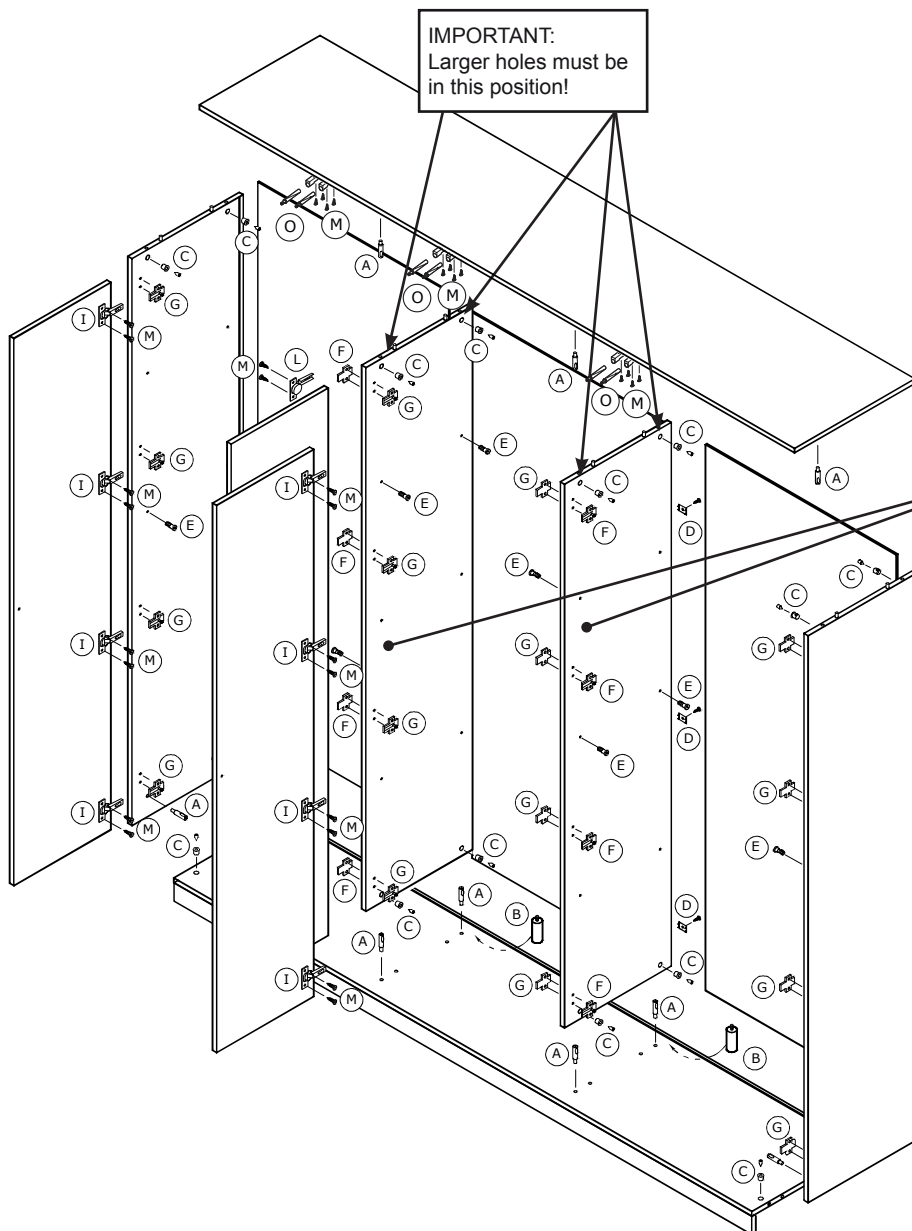
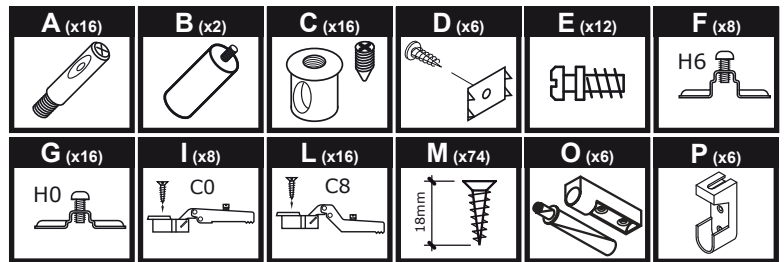
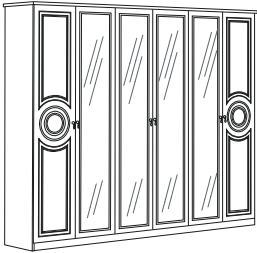
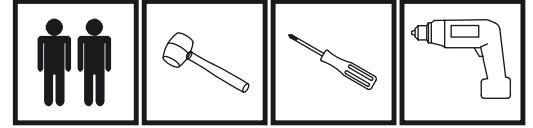

1) Screw the plate for the hinge on the left facing side of the dividing panel;  
2) On opposite side of the dividing panel screw VERY TIGHT the plate for the hinge.

### ASSEMBLING AND ADJUSTING OF DOOR

- A:** Lay a piece of cardboard over the floor for protection of shining surfaces.
- B:** Join side panels and dividing panel to the base see hardware (A), (B), (C) for the proper pegs and eccentrics.
- C:** Slide back panels along the pre-grooved sides.
- D:** First fix the top and then fix back panels with metal brackets (D).
- E:** Fix shelves with their shelf supports (E).
- F:** Fix doors with hinges as per drawing and adjust them as per instructions.
- G:** Fix door stoppers (O).

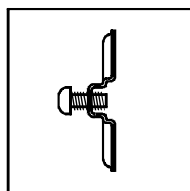

PLATE for HINGE  
h0

CERN. COLLO 0

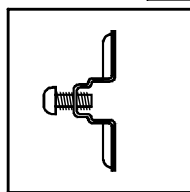

PLATE for HINGE  
h6

CERN. COLLO 8

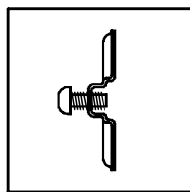

PLATE for HINGE  
h0

CERN. COLLO 8

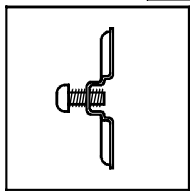

PLATE for HINGE  
h0

CERN. COLLO 8

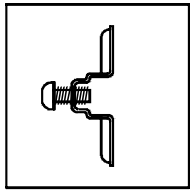

PLATE for HINGE  
h6

CERN. COLLO 8

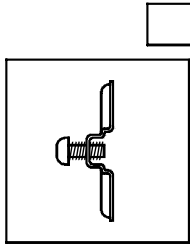
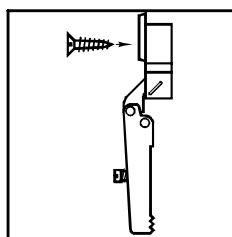

PLATE for HINGE  
h0

CERN. COLLO 0



EXTERNAL  
LATERAL  
DOORS

1

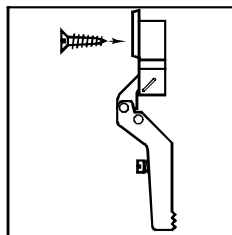

INTERNAL  
LATERAL  
DOORS

2

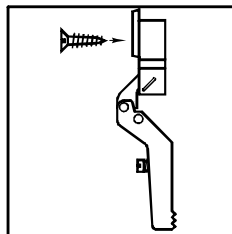

CENTRAL  
GLASS  
DOORS

3

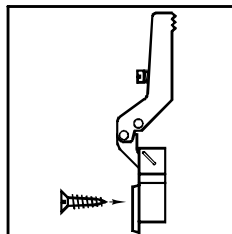

CENTRAL  
GLASS  
DOORS

3

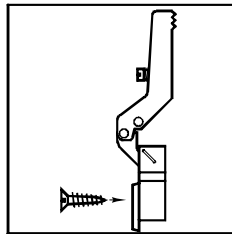

INTERNAL  
LATERAL  
DOORS

2

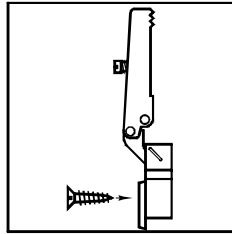

EXTERNAL  
LATERAL  
DOORS

1

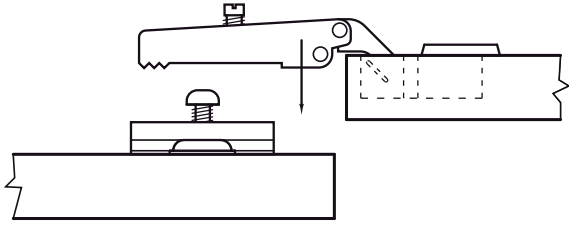

INSERT THE DOORH INGESO VERT HE PLAQUE  
ALREADYFIXED ON THES IDEP ANELS ANDP ARTITION

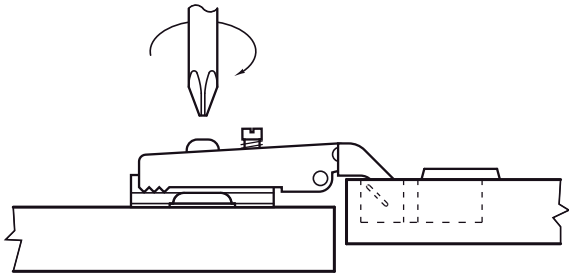

NOWFIX THEH INGESW ITHT HE SCREW

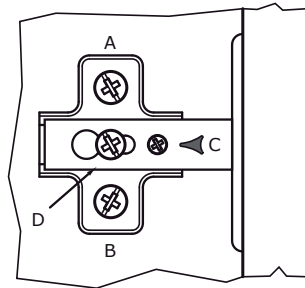
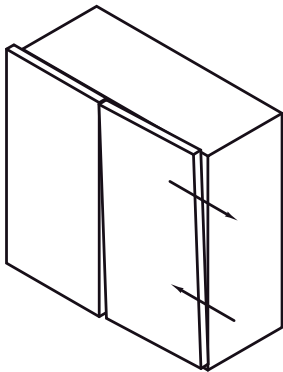

## DOORS ADJUSTMENT

EXAMPLE1  
TO ADJUST THE DOORSO PERATE ON THE  
SPECIAL SCREW( C)

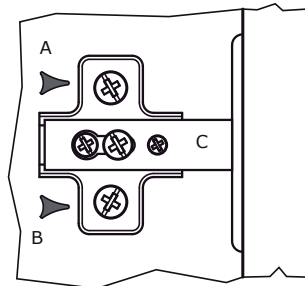
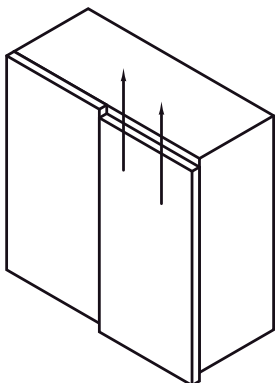

EXAMPLE2  
UNSCREWT HE SCREWS (A+B)A ND ADJUST  
THE DOORSI NT HE RIGHTP OSITION