



ARREDOCLASSIC

Il prestigio del Made in Italy

ADORA
LUXURY-A-PORTER

SCHEMA DI MONTAGGIO VETRINA 1/ ANTA
ASSEMBLING INSTRUCTION FOR 1/DOOR CABINET
INSTRUCTION DE MONTAGE VITRINE 1/PORTE
ИНСТРУКЦИИ ПО МОНТАЖУ ВИТРИНЫ 1/СТВОРКА

— *Modigliani Collection* —



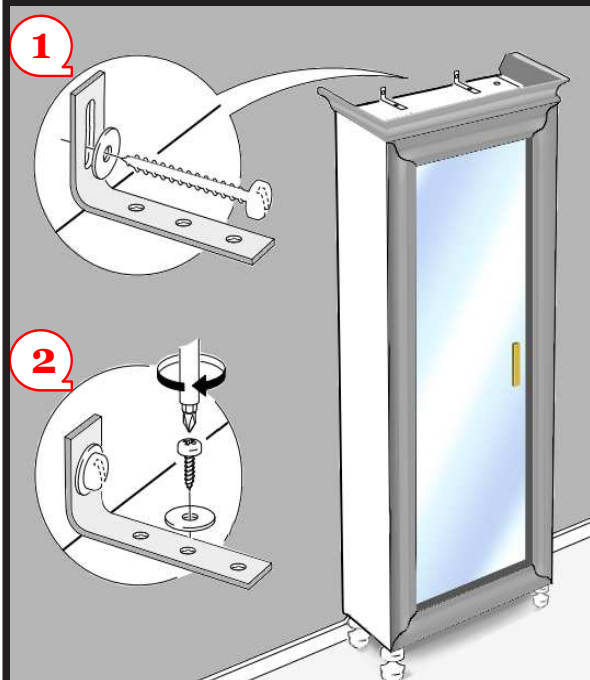

AVVERTENZA Il ribaltamento dei mobili può causare lesioni da schiacciamento gravi o mortali. Per prevenire il rischio che il mobile si ribalti, fissalo alla parete usando gli accessori antiribaltamento inclusi nella confezione. Verifica che la parete sia in grado di sostenerne il peso. Il fissaggio alla parete deve essere effettuato da una persona qualificata, poiché se non viene eseguito correttamente può causare lesioni o danni.

WARNING Overturning furniture may cause serious or fatal injury. To prevent the furniture from overturning, attach it to the wall using the anti-tip accessories included in the package. Check that the wall is able to support its weight. Wall fixing must be carried out by a qualified person, as it can cause injury or damage if it is not done properly.

ПРЕДУПРЕЖДЕНИЕ Перевертывание мебели может привести к серьезным или смертельным травмам. Чтобы мебель не опрокидывалась, прикрепите мебель к стене с помощью антинаконечников, входящих в комплект поставки. Убедитесь, что стена способна поддерживать вес мебели. Настенное крепление должно выполняться квалифицированным персоналом, так как это может привести к травме или повреждению, если оно сделано неправильно.

AVERTISSEMENT Le renversement du meuble peut causer des blessures graves ou mortelles par écrasement. Pour éviter que le meuble ne se renverse, fixez-le au mur à l'aide des accessoires anti-basculement inclus dans l'emballage. Vérifiez que le mur est capable de supporter son poids. La fixation murale doit être effectuée par une personne qualifiée, car cela pourrait causer des blessures ou des dommages si cela n'est pas fait correctement.

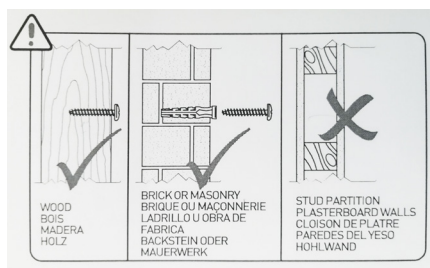

PULIZIA E MANUTENZIONE MOBILI

Per la pulizia di tutti i ns. mobili usare un panno di soffice cotone debitamente umidificato con una miscela di 50% acqua + 50% alcool etilico (uso disinfettante). Non usare mai il panno asciutto, poiché creerebbe dei micro graffi. Non usare prodotti aggressivi contenenti diluente, acetone o qualsiasi altro agente chimico. Può invece essere usato il "Vetрил" su tutte le superfici, meglio spruzzato sul panno e non direttamente sulle parti verniciate.

CLEANING AND MAINTENANCE FURNITURE

For the cleaning of all our furniture use a soft cotton cloth, duly moistened with a mixture of 50% water + 50% ethyl alcohol (disinfectant use). Never use a dry cloth as it will create micro scratches. Do not use aggressive products containing diluent, acetone or any other chemical ingredient. A glass cleaning product can be used on all surfaces: we advise to spray it on the cloth and not directly on the painted parts.

ЧИСТКА И ОБСЛУЖИВАНИЕ КОРПУСНАЯ МЕБЕЛЬ

Для очистки всей нашей мебели используйте ткань из мягкого хлопка, должным образом увлажненную смесью 50% воды + 50% спирта этилового (используя его как дезинфицирующее средство). Никогда не пользуйтесь сухой тканью, так как остаются в таком случае микро-царапины. Не используйте агрессивные продукты, содержащие растворитель, ацетон или любое другое химическое вещество. Вместо этого может быть использован "ветрил" на всех поверхностях, лучше распылять его сначала на ткань, а не непосредственно на окрашенные поверхности.

NETTOYAGE ET MANUTENTION MEUBLES

Pour le nettoyage de tous nos meubles utilisez un chiffon en coton doux dûment humidifié avec un mélange de 50% d'eau + 50% d'alcool éthylique (utilisation de désinfectant). N'utilisez jamais le chiffon sec car cela créerait des micro-rayures. N'utilisez pas de produits agressifs contenant du diluant, de l'acétone ou tout autre agent chimique. Plutôt, un produit de nettoyage de verre peut être utilisé sur toutes les surfaces; il faudrait l'asperger sur le tissu et non directement sur les parties peintes.

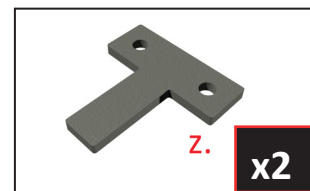
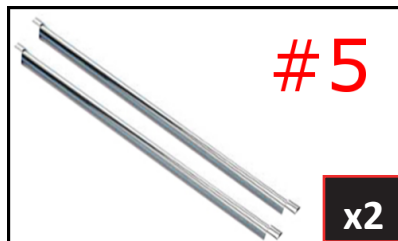
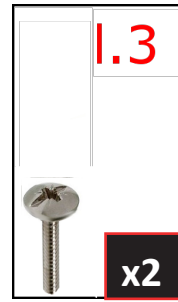
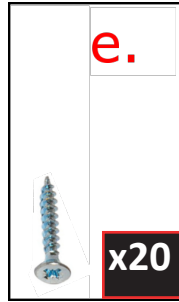
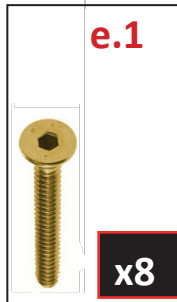



ARREDOCLASSIC

Il prestigio del Made in Italy

ADORA
LUXURY-A-PORTER

SCHEMA DI MONTAGGIO VETRINA 1/ ANTA
ASSEMBLING INSTRUCTION FOR 1/DOOR CABINET
INSTRUCTION DE MONTAGE VITRINE 1/PORTE
ИНСТРУКЦИИ ПО МОНТАЖУ ВИТРИНЫ 1/СТВОРКА

— Modigliani Collection —

1

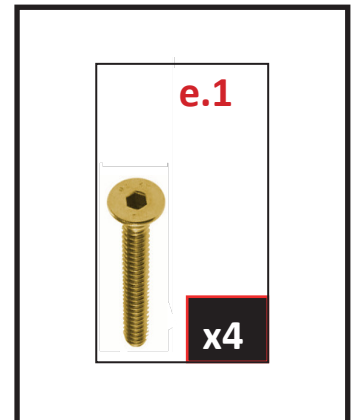
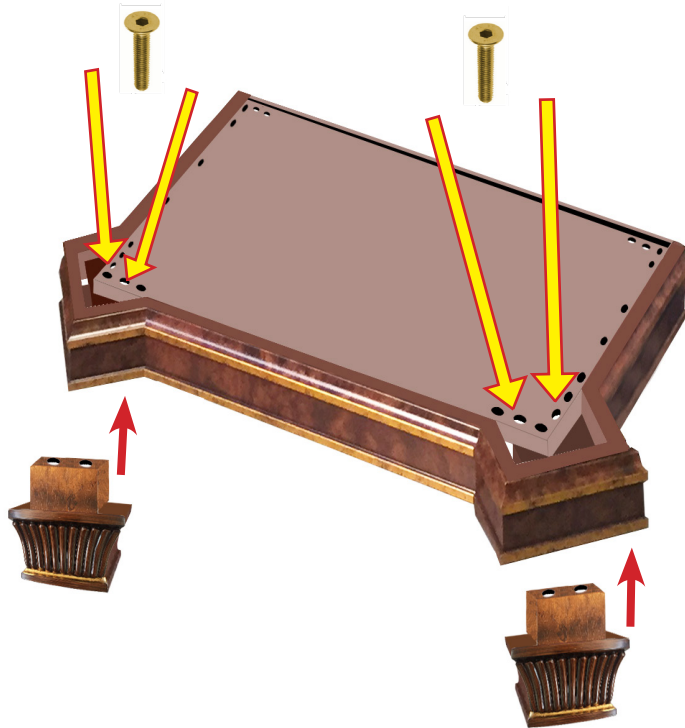

2

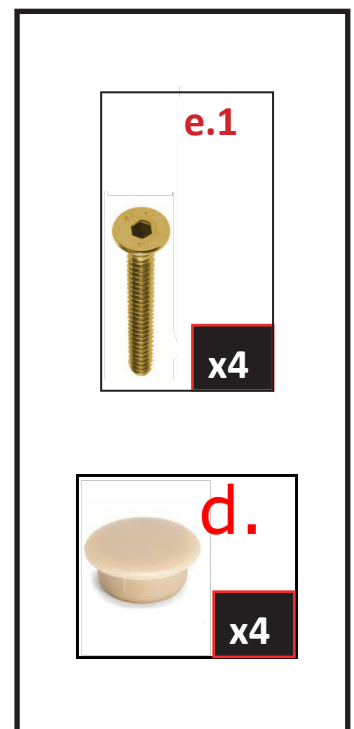
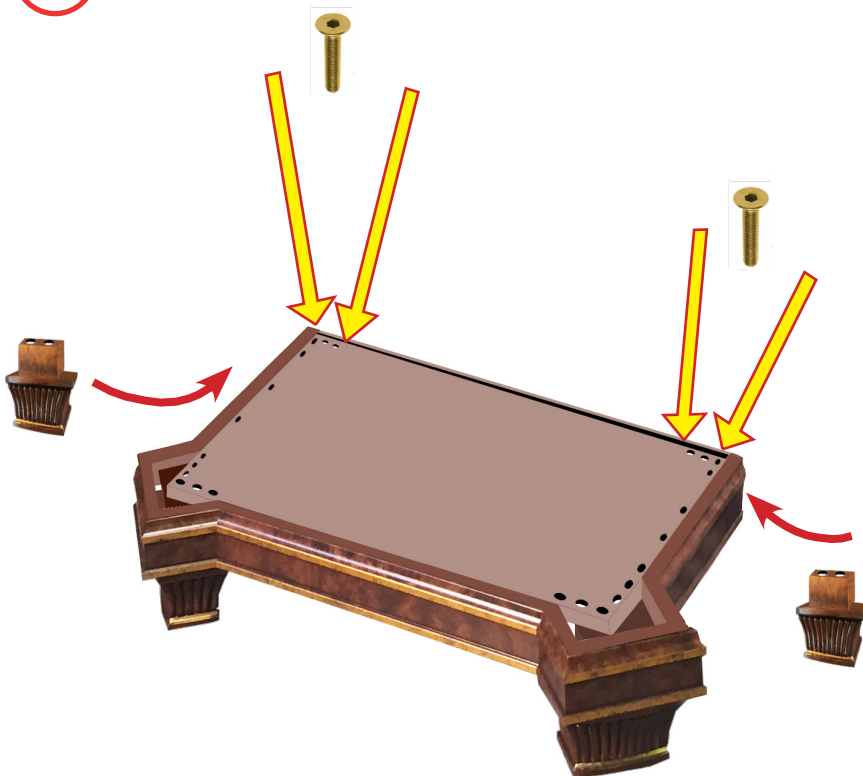



ARREDOCLASSIC

Il prestigio del Made in Italy

ADORA
LUXURY-A-PORTER

SCHEMA DI MONTAGGIO VETRINA 1/ ANTA
ASSEMBLING INSTRUCTION FOR 1/DOOR CABINET
INSTRUCTION DE MONTAGE VITRINE 1/PORTE
ИНСТРУКЦИИ ПО МОНТАЖУ ВИТРИНЫ 1/СТВОРКА

— Modigliani Collection —

3

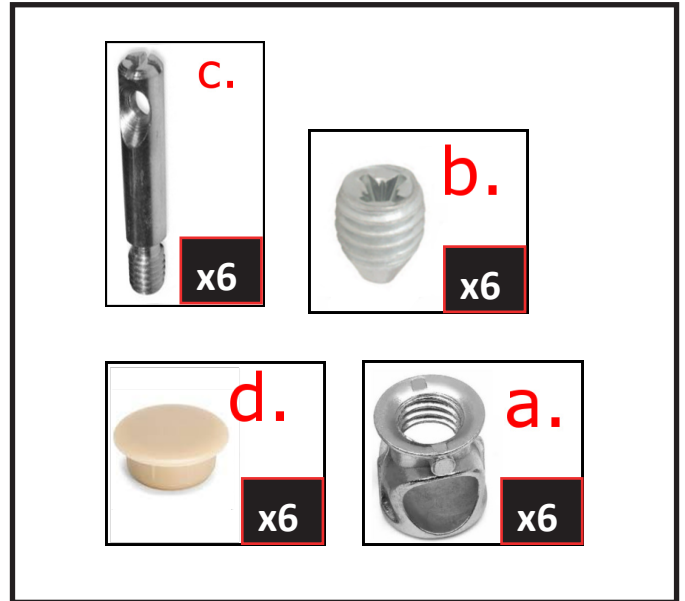

4



5

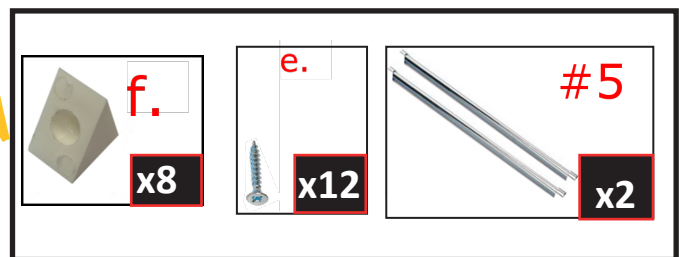
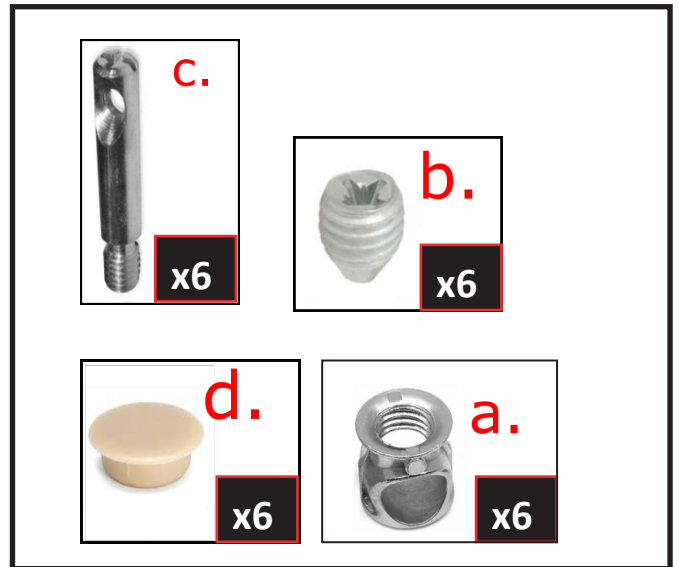

6

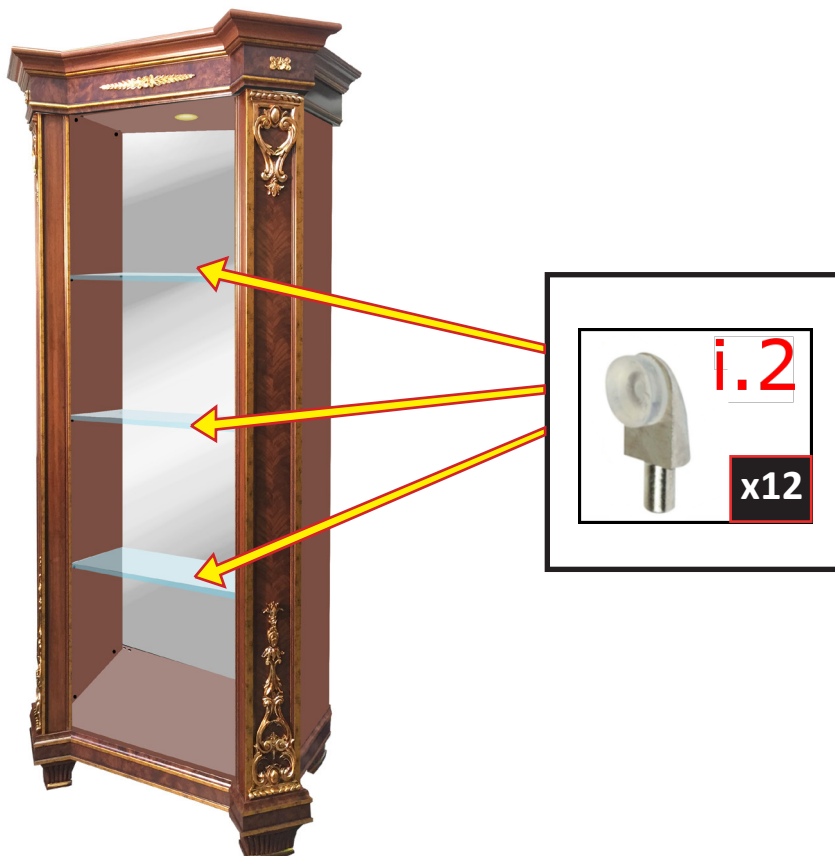

7
A-B

È POSSIBILE MONTARE L'ANTA NEL FIANCO SX **A** O NEL FIANCO DX **B**
THE DOOR CAN BE ASSEMBLED EITHER ON THE LEFT **A** AS ON THE RIGHT PANEL **B**
LA PORTE PEUT ÊTRE ASSEMBLE LA PORTE SOIT SUR LE CÔTÉ GAUCHE **A** QUE SUR LE CÔTÉ DROITE **B**
МОЖНО УСТАНОВИТЬ ДВЕРЬ С ЛЕВОЙ **A** СТОРОНЫ ИЛИ С ПРАВОЙ СТОРОНЫ **B**

A

+ VETRINA SX: MONTARE LE BASETTE SUL FIANCO SINISTRO.

+ LEFT (FACING) CABINET: SET UP THE BASE FOR HINGES ON LEFT SIDE PANEL.

+ VITRINE GAUCHE: MONTER LES BASES POUR CHARNIERES SUR LE COTE GAUCHE.

+ ЛЕВАЯ ВИТРИНА: МОНТИРУЙТЕ КРЕПЕЖ ДЛЯ ПОДПОЛОЧНИКОВ К ЛЕВОМУ БОКУ

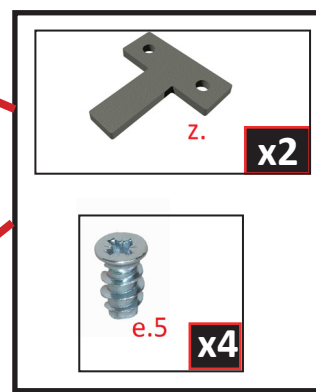
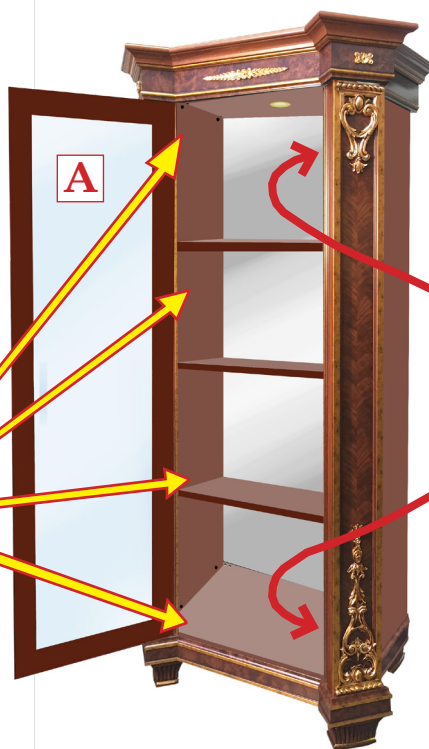
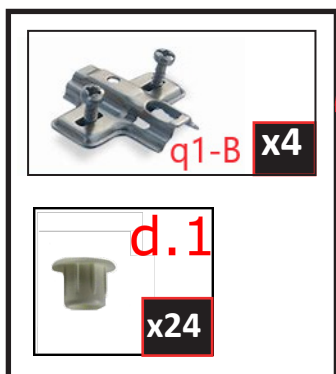

B

+ VETRINA DX: MONTARE LE BASETTE SUL FIANCO DESTRO.

+ RIGHT (FACING) CABINET: SET UP THE BASE (FOR HINGES ON RIGHT SIDE PANEL).

+ VITRINE DROITE: MONTER LES BASES POUR CHARNIERES SUR LE COTE DROITE.

+ ПРАВАЯ ВИТРИНА: МОНТИРУЙТЕ КРЕПЕЖ ДЛЯ ПОДПОЛОЧНИКОВ К ПРАВОВОМУ БОКУ.

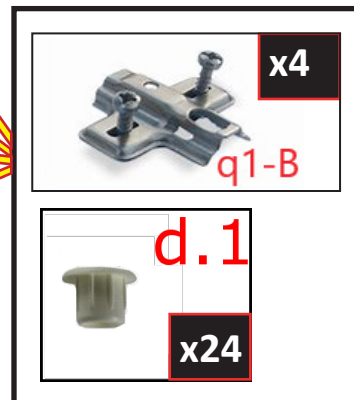
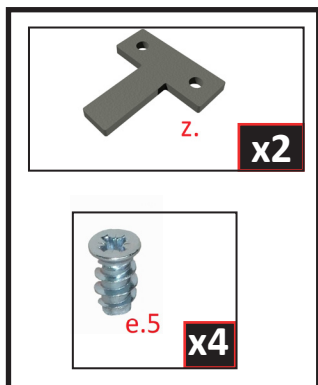

8

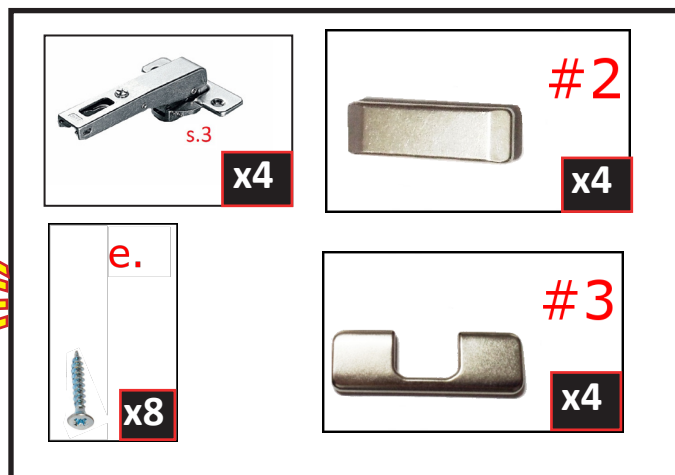

9

