



ARREDOCLASSIC

Il prestigio del Made in Italy

ADORA
LUXURY-À-PORTER

SCHEMA DI MONTAGGIO ARMADIO 4/ ANTE
ASSEMBLING INSTRUCTION FOR 4/DOORS WARDROBE
INSTRUCTION DE MONTAGE ARMOIRE 4/ PORTES
ИНСТРУКЦИИ ПО МОНТАЖУ ШКАФА 4/СТВОРКИ

— Dolcevita collection —





AVVERTENZA

Se il mobile si ribalta può causare lesioni da schiacciamento serie o fatali. Per prevenire il rischio che il mobile si ribalti, quest'ultimo deve essere fissato alla parete.

Gli accessori per il fissaggio alla parete non sono inclusi perché pareti di materiali diversi richiedono tipi diversi di accessori di fissaggio. Usa sistemi di fissaggio adatti alle pareti della tua casa.

WARNING

If the cabinet overturns it can cause serious or fatal crushing injuries. To prevent the risk of the furniture tipping over, it must be fixed to the wall.

Wall-mounting accessories are not included because walls of different materials require different types of fixing accessories. Use fixing systems suitable for the walls of your home.

AVERTISSEMENT

Le renversement du meuble peut causer des blessures graves ou mortelles par écrasement. Pour éviter que le meuble ne se renverse, fixez-le au mur à l'aide des accessoires anti-basculement inclus dans l'emballage. Vérifiez que le mur est capable de supporter son poids. La fixation murale doit être effectuée par une personne qualifiée, car cela pourrait causer des blessures ou des dommages si cela n'est pas fait correctement.

ПРЕДУПРЕЖДЕНИЕ

Перевертывание мебели может привести к серьезным или смертельным травмам. Чтобы мебель не опрокидывалась, прикрепите мебель к стене с помощью анти-наконечников, входящих в комплект поставки. Убедитесь, что стена способна поддерживать вес мебели. Настенное крепление должно выполняться квалифицированным персоналом, так как это может привести к травме или повреждению, если оно сделано неправильно.



PULIZIA E MANUTENZIONE

MOBILI

Per la pulizia di tutti i ns. mobili usare un panno di soffice cotone debitamente umidificato con una miscela di 50% acqua + 50% alcool etilico (uso disinfettante). Non usare mai il panno asciutto, poiché creerebbe dei micro graffi. Non usare prodotti aggressivi contenenti diluente, acetone o qualsiasi altro agente chimico. Può invece essere usato il "Vetрил" su tutte le superfici, meglio spruzzato sul panno e non direttamente sulle parti verniciate.

CLEANING AND MAINTENANCE

FURNITURE

For the cleaning of all our furniture use a soft cotton cloth, duly moistened with a mixture of 50% water + 50% ethyl alcohol (disinfectant use). Never use a dry cloth as it will create micro scratches. Do not use aggressive products containing diluent, acetone or any other chemical ingredient. A glass cleaning product can be used on all surfaces: we advise to spray it on the cloth and not directly on the painted parts.

ЧИСТКА И ОБСЛУЖИВАНИЕ

КОРПУСНАЯ МЕБЕЛЬ

Для очистки всей нашей мебели используйте ткань из мягкого хлопка, должным образом увлажненную смесью 50% воды + 50% спирта этилового (используя его как дезинфицирующее средство). Никогда не пользуйтесь сухой тканью, так как остаются в таком случае микро-царапины. Не используйте агрессивные продукты, содержащие растворитель, ацетон или любое другое химическое вещество. Вместо этого может быть использован "ветрил" на всех поверхностях, лучше распылять его сначала на ткань, а не непосредственно на окрашенные поверхности.

NETTOYAGE ET MANUTENTION

MEUBLES

Pour le nettoyage de tous nos meubles utilisez un chiffon en coton doux dûment humidifié avec un mélange de 50% d'eau + 50% d'alcool éthylique (utilisation de désinfectant). N'utilisez jamais le chiffon sec car cela créerait des micro-rayures. N'utilisez pas de produits agressifs contenant du diluant, de l'acétone ou tout autre agent chimique. Plutôt, un produit de nettoyage de verre peut être utilisé sur toutes les surfaces; il faudrait l'asperger sur le tissu et non directement sur les parties peintes.

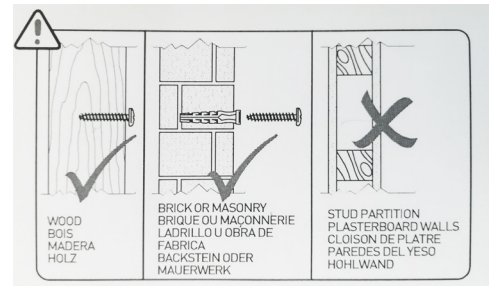

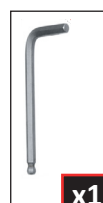
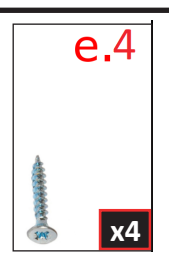
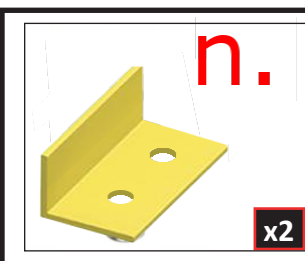
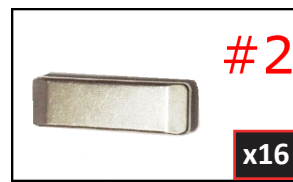
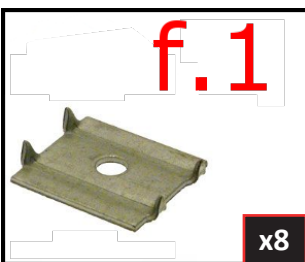
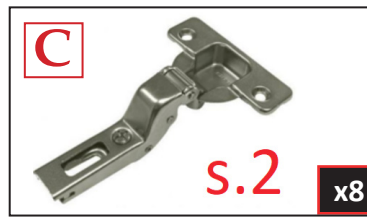
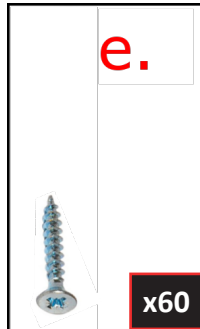
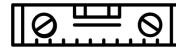
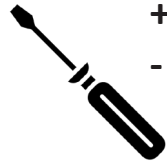

1



2

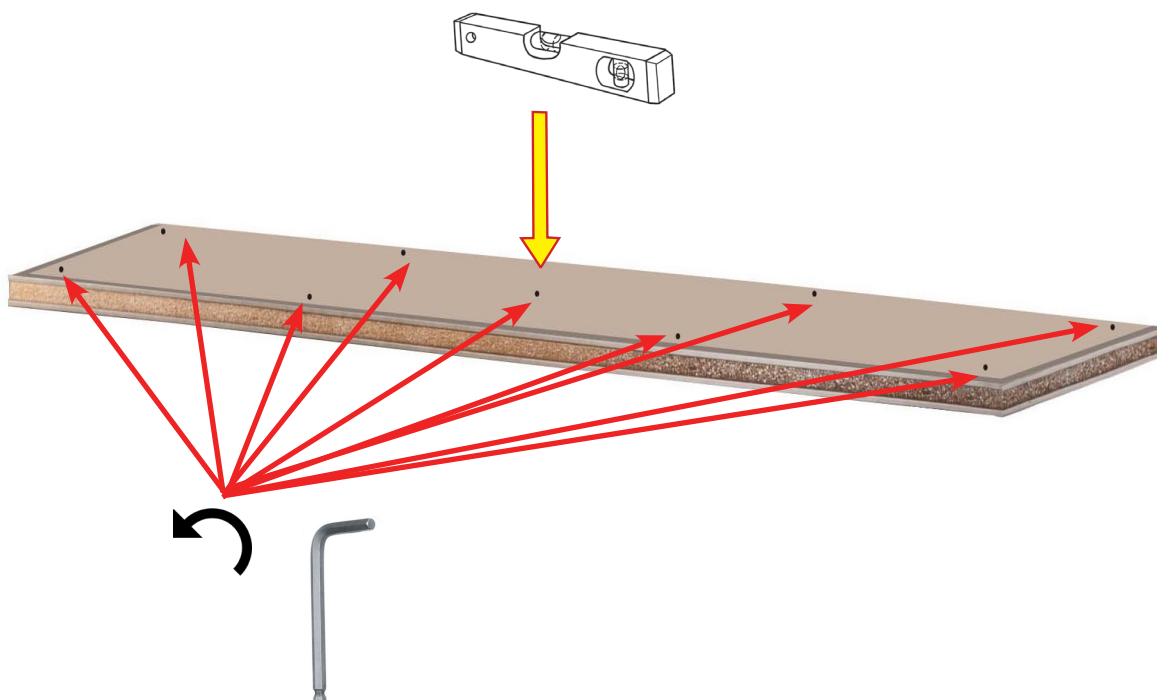

3

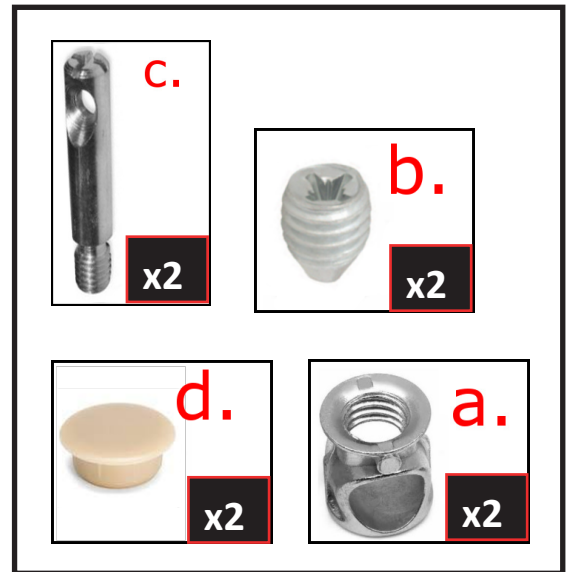
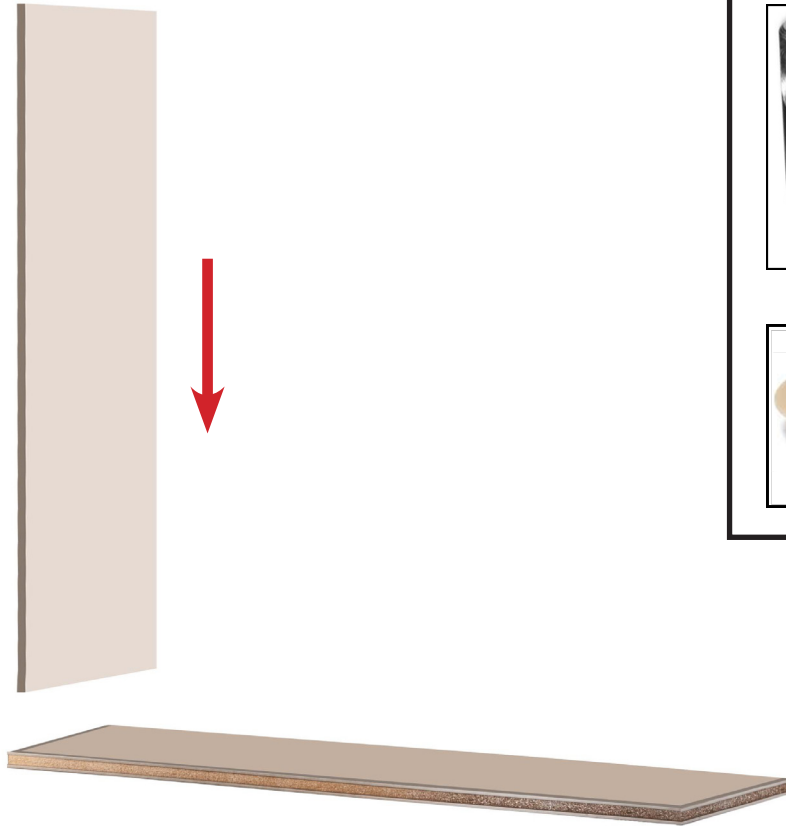

4

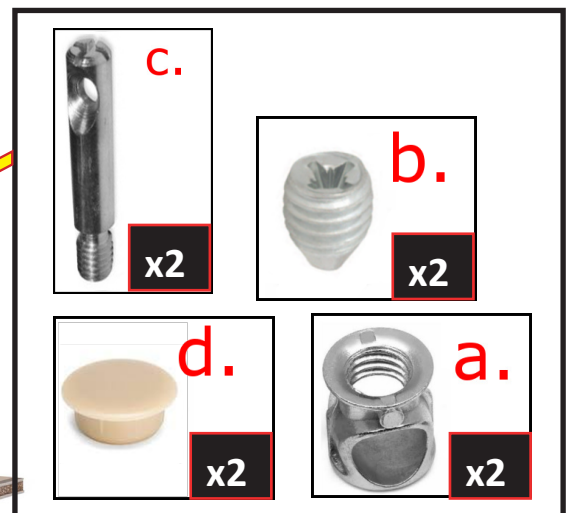
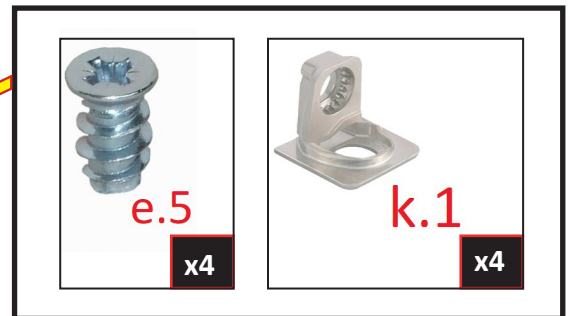
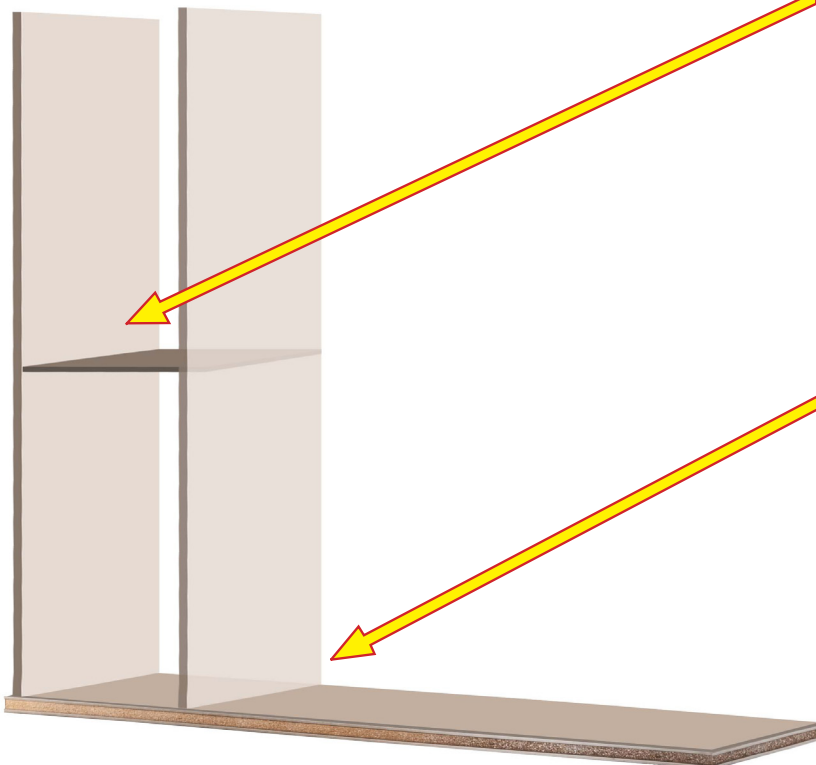

5

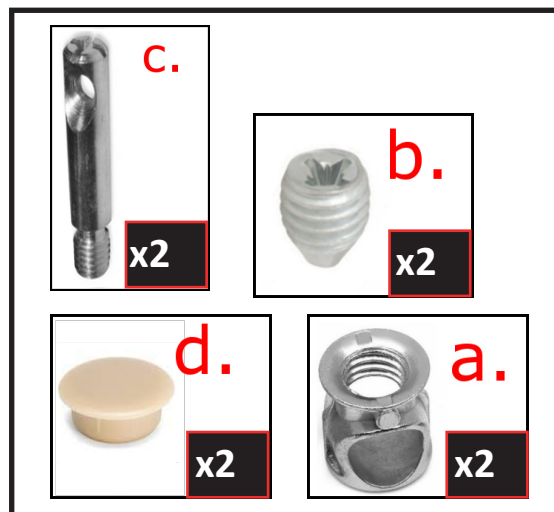
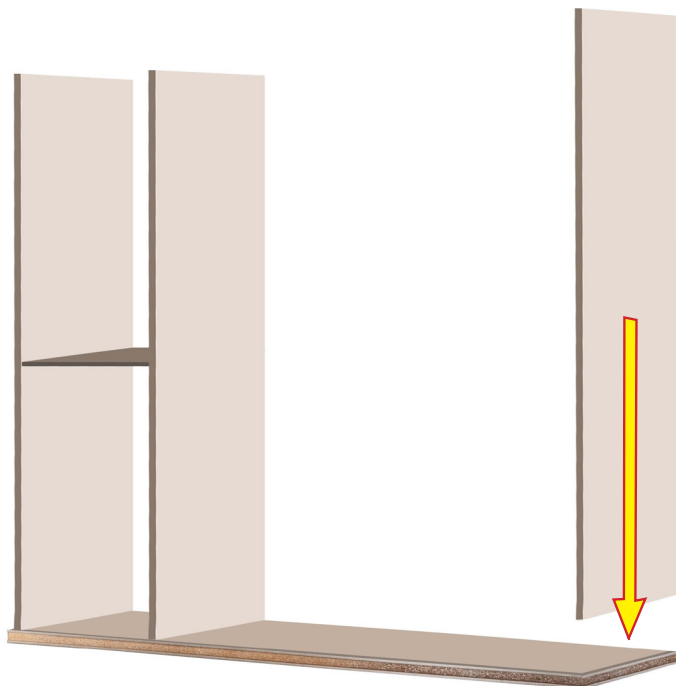

6

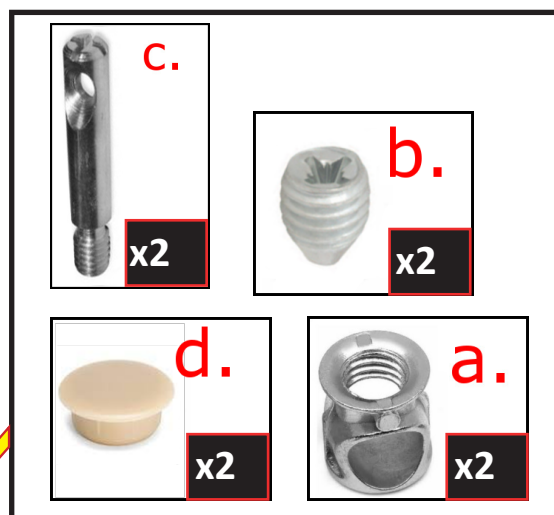
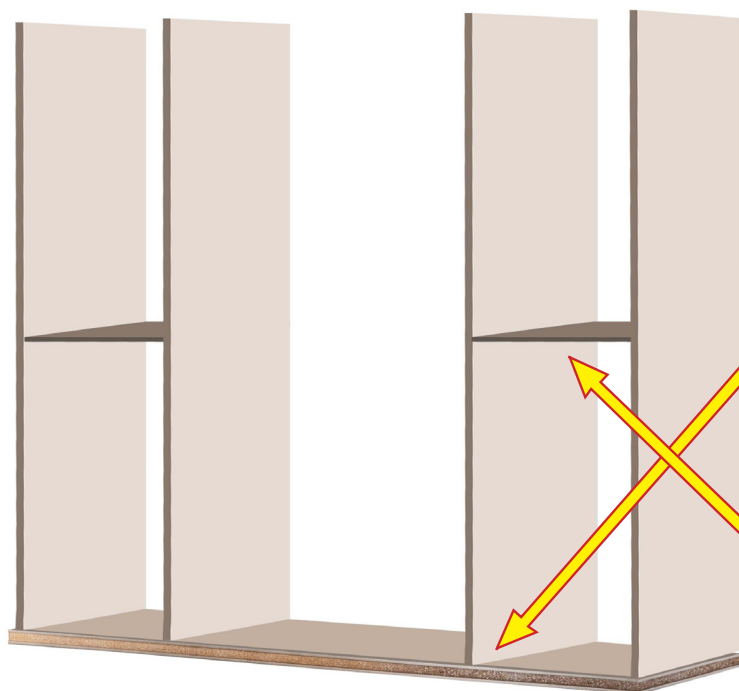

7

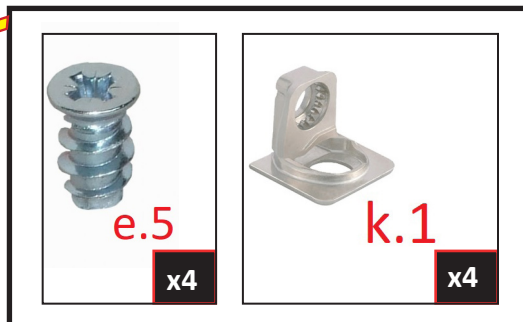
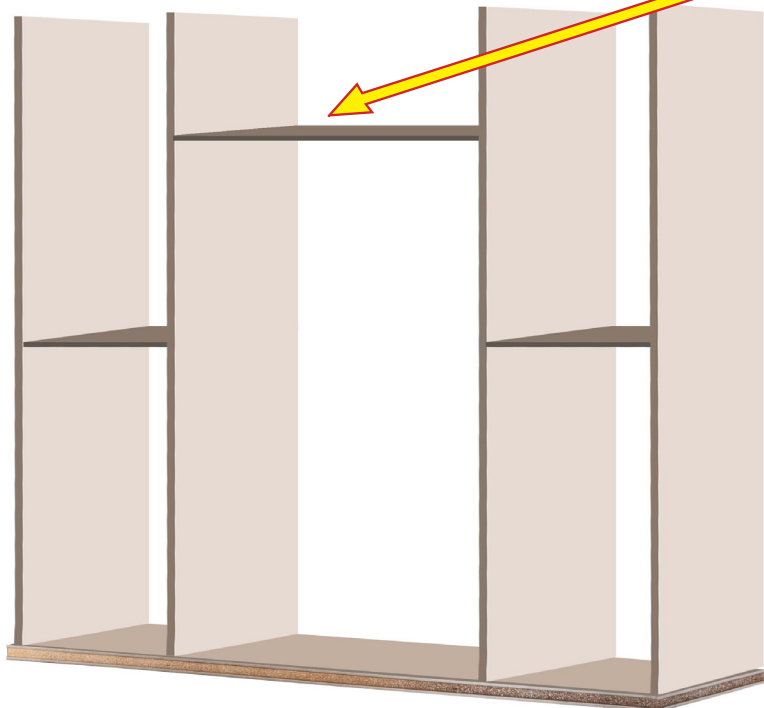

8

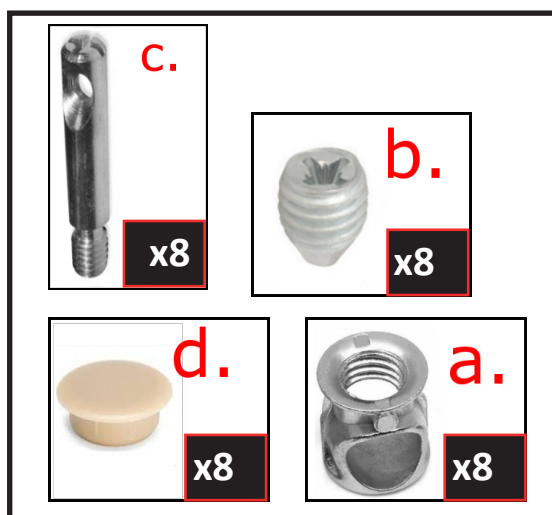
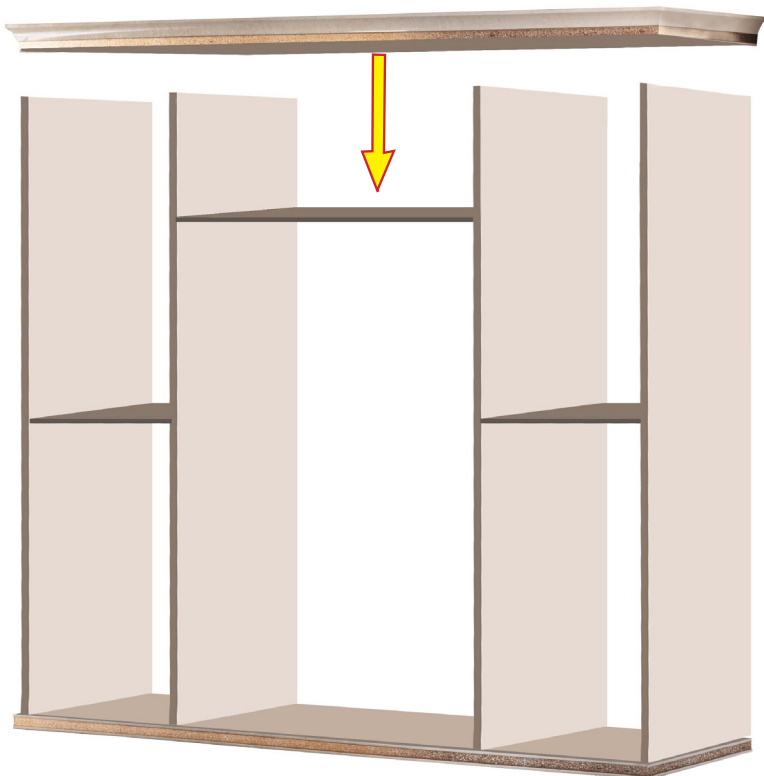

9

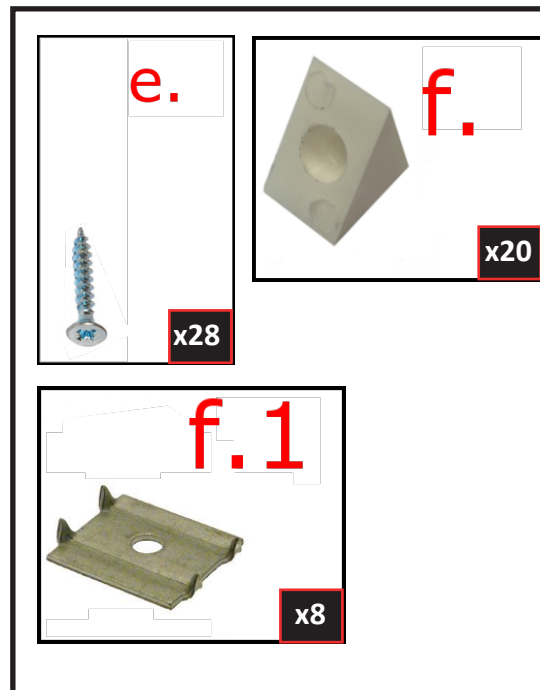
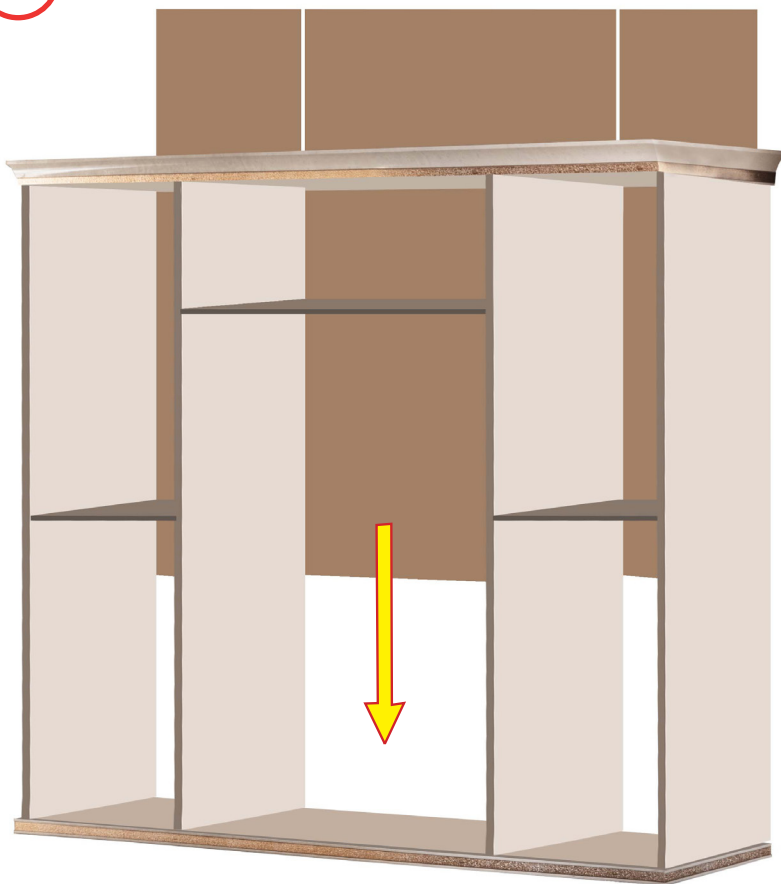

10

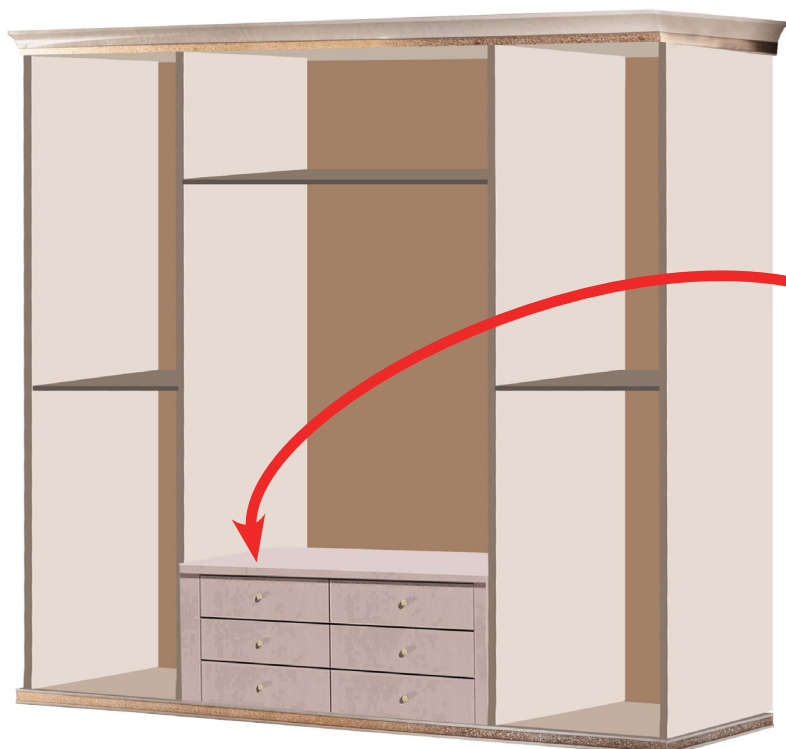

11

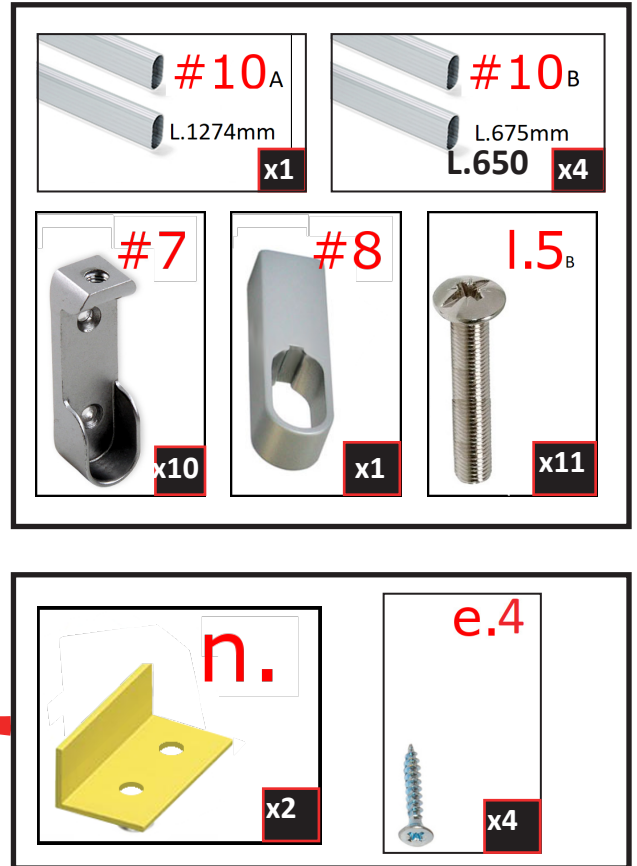
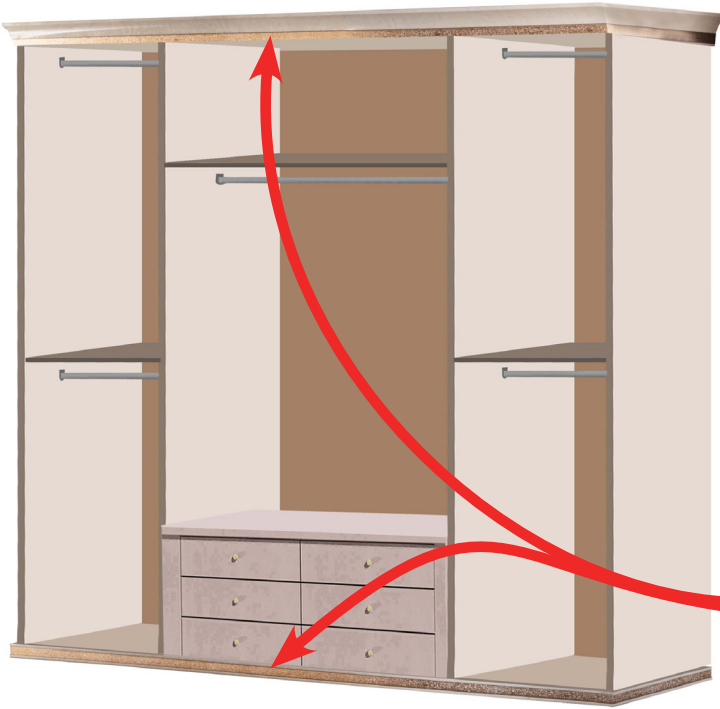

12

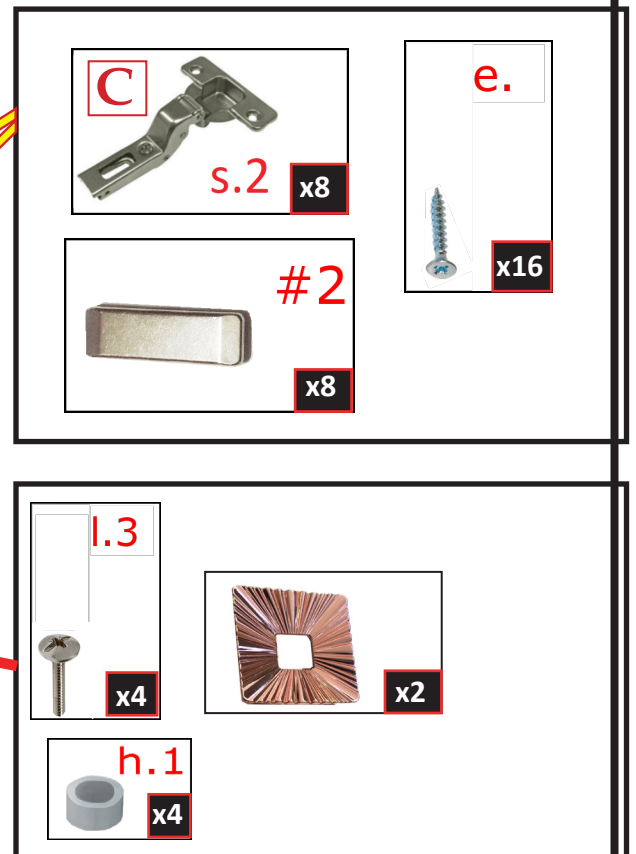
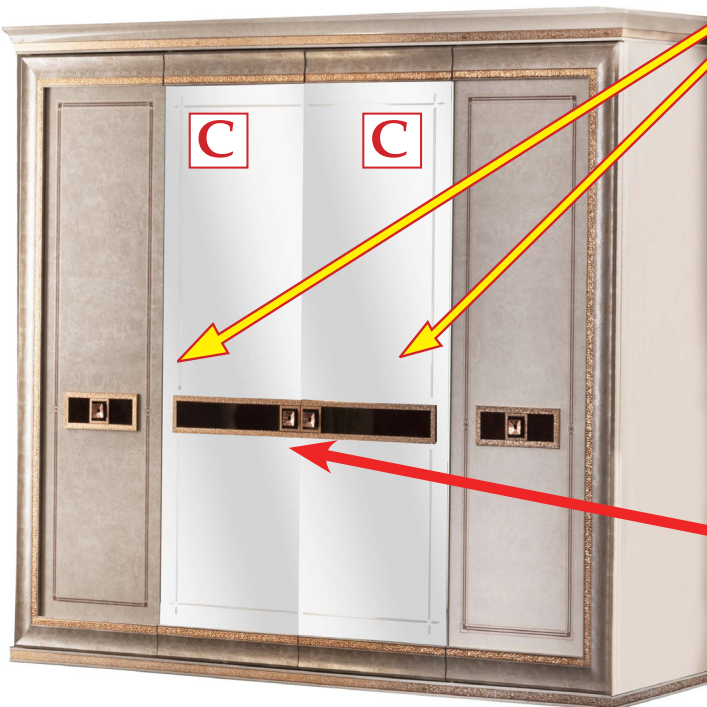

13

