

TP x comodino?

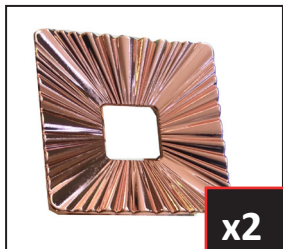

TP x GAMBA

?

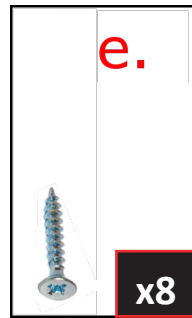
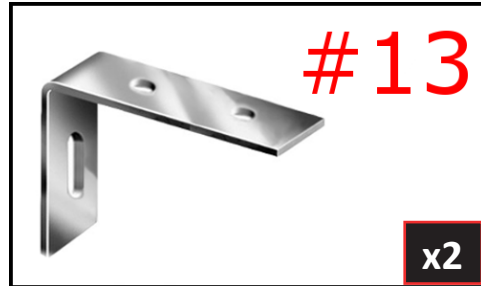

1

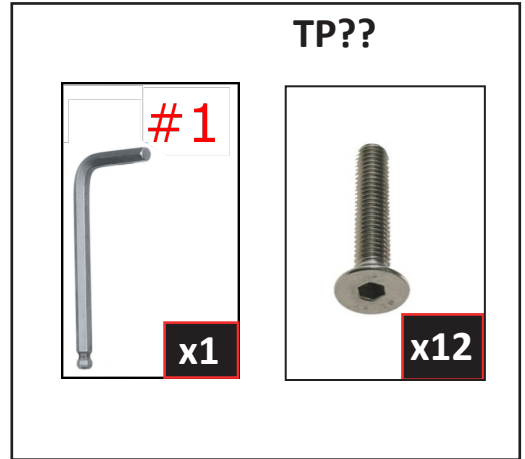
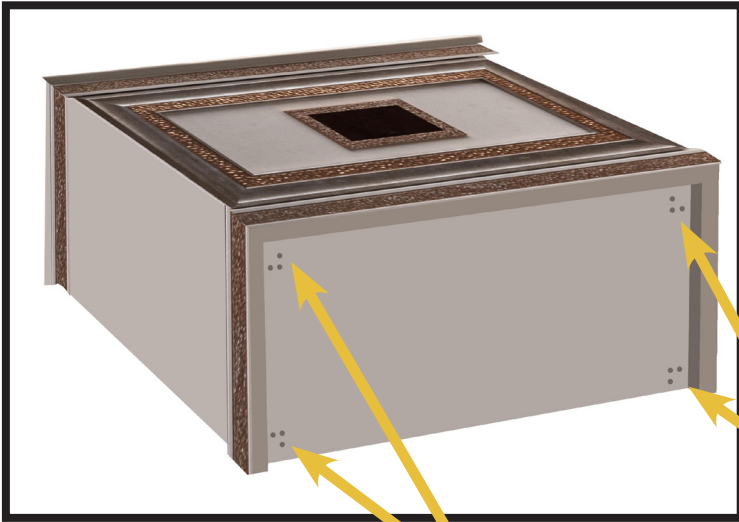

2



??

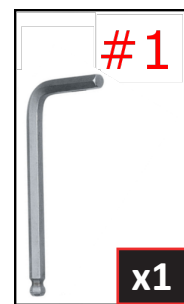

Tbl ?



3



TP??



4

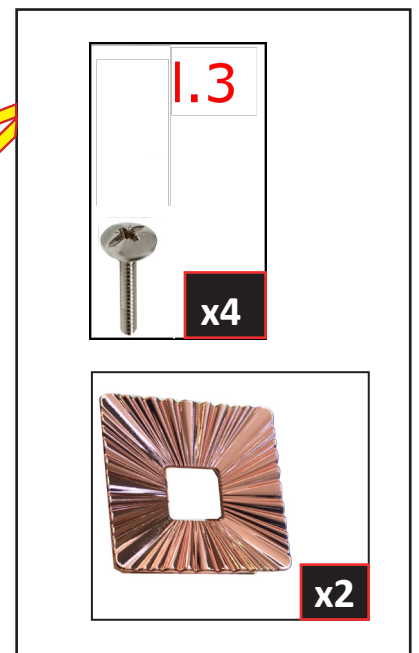
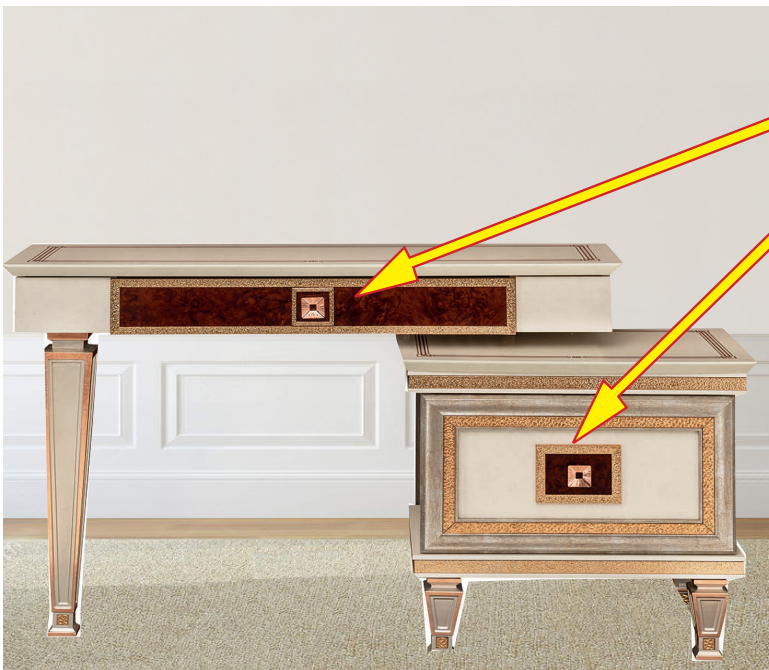

4

?

